

**SUBMITTAL TO THE BOARD OF DIRECTORS
COUNTY OF RIVERSIDE, STATE OF CALIFORNIA**

107



SUBMITTAL DATE:
June 30, 2014

FROM: Regional Park and Open-Space District

SUBJECT: Salt Creek Trails Engineering, Design and Environmental Consulting Services Agreement – Amendment; District 1 and 3; [\$191,650] [Multiple Funding Sources]

RECOMMENDED MOTION: That the Board of Directors:

1. Authorize the Chair of the Board of Directors to execute Amendment One for Consultant Services Agreement;
2. Direct the Clerk of the Board to return four (4) copies of each executed Amendments to the Regional Park and Open-Space District for processing and distribution; and
3. Approve and direct the Auditor-Controller to make the budget adjustments shown on Schedule A, attached.

BACKGROUND:

Summary

The Salt Creek Trail project is one of five (5) major Regional Trails for western Riverside County designed to provide connections to cities, communities, commercial areas, schools and recreational facilities and serve as “backbone trail” for the County’s Trail system.

(continued on page 2)

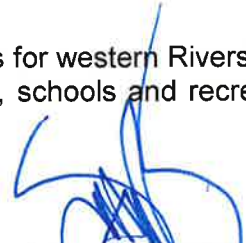

Scott Bangle
General Manager

2015-004D MB

FINANCIAL DATA	Current Fiscal Year:	Next Fiscal Year:	Total Cost:	Ongoing Cost:	POLICY/CONSENT (per Exec. Office)
COST	\$ 191,650	\$ 0	\$ 191,650	\$ 0	Consent <input type="checkbox"/> Policy <input checked="" type="checkbox"/>
NET COUNTY COST	\$ 0	\$ 0	\$ 0	\$ 0	

SOURCE OF FUNDS: DIF Western Trails Fund 30533 (Previously approved budget), District Fund Balance Reserved for Capital Improvements, MWD Contribution	Budget Adjustment: Yes
	For Fiscal Year: 14/15

C.E.O. RECOMMENDATION:

APPROVE

BY: 
Alex Gann

County Executive Office Signature

MINUTES OF THE BOARD OF SUPERVISORS

FISCAL PROCEDURES APPROVED
 PAUL ANGULO, CPA, AUDITOR-CONTROLLER
 BY:  7/10/14
 Esteban Hernandez
 Departmental Concurrence

FORM APPROVED COUNTY COUNSEL
 BY:  7/1/14
 NEAL R. KIPNIS
 DATE

- A-30
- 4/5 Vote
- Positions Added
- Change Order

BACKGROUND:

Summary (continued)

The proposed Trail route will follow Riverside County Flood Control and Water Conservation District's Salt Creek Channel. The Trail will have a total length of 15.8 miles. It will connect the City of Canyon Lake to the City of Hemet with a bicycling path and soft surface multi-purpose trail as well as meet the design objective of a "backbone trail" as outlined above.

On September 24, 2013 by Minute Order 13.1D the Board approved a Consultant Services Agreement between the KTU+A Planning and Landscape Architecture, San Diego, California (Consultant) and the Riverside County Regional Park and Open-Space District (District) for the design and development documentation for the Salt Creek Trail Project (Trail).

The District partnered with the Riverside County Transportation and Land Management Agency, Transportation Division to secure funds for the Trail's phased development. In January 2014, the agencies were successful in obtaining a federally funded grant through the Riverside County Transportation Commission (RCTC) in the amount of \$5,090,000 for the construction of Phase I, a 4 mile segment of Trail from the City of Canyon Lake to Menifee Lakes, City of Menifee and Phase II, a 3.2 mile segment of Trail from Sanderson Avenue to State Street in Hemet, for a total of 7.2 miles of Trail. The federal grant program requires environmental compliance with both California Environmental Quality Act (CEQA) and National Environmental Protection Act (NEPA) requirements. The Consultant Agreement, Attachment "A" requires the Consultant to comply with CEQA on the project. The District requested the Consultant to submit the cost to complete the NEPA compliance work. The Consultant submitted a cost of \$139,740.00. The District has reviewed the tasks and cost. The cost is in compliance with industry standards. The fee proposal has been submitted as part of Amendment One of the Professional Services Agreement – Change Order Documents, Attachment "B".

An additional opportunity emerged when the District conducted a meeting with Metropolitan Water District (MWD) representatives to discuss the Salt Creek Trail. Inquiries regarding recreation trails through Western Riverside Multi-Species Reserve lands provided a path to initiating planning efforts that have long been stalled. MWD and the District agreed in concept to a cost sharing alliance, whereby both would equally contribute to developing a plan that would evaluate appropriate locations and analyze impacts and ability to design and develop a sustainable trail through potentially sensitive habitat areas before recommending the primary and alternate trail routes. The District requested that the Consultant submit a cost estimate to complete the work. The Consultant submitted a cost of \$51,910.00 to complete the work which has been reviewed by staff. The cost is in compliance with industry standards. The fee proposal has been submitted as part of Amendment One of the Professional Services Agreement – Change Order Documents Attachment "B".

Impact on Citizens and Businesses

The Trail, when complete, will provide the residents of the County of Riverside a multipurpose recreation trail and a paved Class I Bike Path between the cities of Canyon Lake and Hemet. It will offer a safer alternate urban commuter route to the communities. It will provide the opportunity for expansion of local and regional trail systems, sidewalks and bike path connections from the Trail to surrounding communities, schools, commercial areas and two key regional recreation facilities at Lake Skinner and Diamond Valley Lake. The Trail will provide a new recreational amenity to the area and improve quality of life for residents.

SUBMITTAL TO THE BOARD OF DIRECTORS, COUNTY OF RIVERSIDE, STATE OF CALIFORNIA
FORM 11: Salt Creek Trails Engineering, Design and Environmental Consulting Services Agreement –
Amendment; District 1 and 3; [\$191,650] [Multiple Funding Sources]

DATE: June 30, 2014

PAGE: 3 of 3

Fiscal Information

On July 3, 2012 by Minute Order 13.1 your honorable board approved the allocation and use of Fund 30533 Development Impacts Fee Western Riverside County Regional Multipurpose Trails for costs associated with trail expansion for Lake Skinner, McCall Park – Hurkey Creek Park Connector Trail, and Salt Creek Trail. The \$139,740 of work described in Change Order Documents, Attachment “B” will be paid for with the remaining \$92,142 available from this DIF allocation and \$47,598 from the District’s Fund Balance Reserved for Capital Improvements in Fund 33100 Park Acquisition & Development.

The \$51,910 addition to this project and described in Change Order Documents, Attachment “B” will be funded by a \$25,000 contribution from the Metropolitan Water District of Southern California and \$26,910 from the District’s Fund Balance Reserved for Capital Improvements in Fund 33100 Park Acquisition & Development.

Contract History and Price Reasonableness

KTU+A is the Consultant of Record on this project. The agreement between the District and Consultant is being expanded to include additional unanticipated elements to the project. The District has reviewed the fee proposals with the Consultant and its team. The District believes the fees are fair and in accord with industry standard for this type of work.

County Counsel approved as to form.

ATTACHMENTS:

Consultant Agreement – Attachment “A”
Change Order Documents - Attachment “B”
Change Order Report
Schedule A

MINUTES OF THE BOARD OF DIRECTORS
COUNTY OF RIVERSIDE, STATE OF CALIFORNIA



13-2D

On motion of Supervisor Stone, seconded by Supervisor Ashley and duly carried by unanimous vote, IT WAS ORDERED that the recommendation from Regional Park and Open-Space District regarding Approval of Amendment No. 1 to Consultant Services Agreement with KTU+A Planning and Landscape Architecture for the Salt Creek Trails Engineering, Design and Environmental Consulting Services, 1st/1st, 3rd/3rd Districts, is continued to Tuesday, August 5, 2014 at 10:30 a.m.

I hereby certify that the foregoing is a full true, and correct copy of an order made and entered on July 29, 2014 of Supervisors Minutes.

(seal)

WITNESS my hand and the seal of the Board of Supervisors
Dated: July 29, 2014
Kecia Harper-Ihem, Clerk of the Board of Supervisors, in
and for the County of Riverside, State of California.

By:  Deputy

AGENDA NO.
13-2D

xc: Parks, COB

ATTACHMENT "A"
CONSULTANT AGREEMENT

**ENGINEERING, DESIGN & ENVIRONMENTAL
CONSULTING SERVICE AGREEMENT
BY AND BETWEEN THE
RIVERSIDE COUNTY REGIONAL PARK AND OPEN-SPACE DISTRICT
AND
KTU+A PLANNING & LANDSCAPE ARCHITECTURE**

The Riverside County Regional Park and Open-Space District, herein called "DISTRICT" and KTU+A Planning & Landscape Architecture, herein called "CONSULTANT," mutually agree as follows:

I. DESCRIPTION

The CONSULTANT shall render services to the DISTRICT as described in this Agreement for the "project" described as follows:

Design, Engineering, and Environmental Services for the Salt Creek Trail Project of the Riverside County Regional Park and Open-Space District, Riverside County, State of California

The following documents are incorporated into and made part of this Agreement:

Exhibit A: CONSULTANT Fees

Exhibit B: CONSULTANT Proposal

Exhibit C: DISTRICT Request for Qualifications #PKARC 140 (Not attached)

Exhibit D: Period of Performance

In the event of a conflict between the terms of the documents made part of this Agreement, the following apply: The terms of this Agreement shall take precedence over the Exhibits. Exhibits A, C & D shall take precedence over Exhibit B.

II. CONSULTANT'S SERVICES:

The CONSULTANT shall render the following services and usual related services. Scope of services shall be agreed upon in writing prior to commencement of the project.

A. Design and Engineering Services:

The Consultant shall assign a project manager to the project. The same project manager shall manage the project from inception to completion. The work will proceed in the following order:

1. Survey Work and Calculations

The District will provide the Consultant with the most current topographic survey of the channel from the Riverside County Flood Control and Water Conservation District. It will be the Consultant's responsibility to have any additional survey work completed for the project.

The Consultant shall inspect the site and the surrounding area.

Consultant shall meet with District staff and staff from other agencies to learn about the existing

channel and right-of-way, the needs of the proposed trail, and ways to integrate the proposed new trail into the existing right-of-way.

Consultant shall plan to visit the project site and the surrounding area as required to do any research. Consultant shall plan at least four (4) meetings with the various agencies, including the District.

2. Design

a. Program Refinement/Preliminary Site Plan Design:

The Consultant shall create two (2) preliminary site plans for District review showing the layout of the proposed trail, interpretive areas, crossings, and any staging areas.

The District will approve or ask for revisions to the site plans and respond in writing. The site plan will be revised, as necessary, by the Consultant. The Consultant will present the revised site plan to the District a second time for final approval. Final approval and comments will be given to the Consultant by the District in writing.

The Consultant shall have a professional cost estimator prepare a detailed cost estimate for all categories of work. In addition, the Consultant will price out all of the categories of cost that a cost estimation typically does not include such as permitting fees, utility connection fees, and any and all other costs so that the District receives a complete cost estimate.

The Consultant should anticipate two (2) meetings for this portion of the project.

a. Final Site Plan Design and Building Costs:

Upon approval of the preliminary site plan, the Consultant shall develop a final site plan showing the entire area where improvements will be made.

The Consultant shall address requirements of all agencies with jurisdiction over the project. Consultant shall describe, in writing, what steps are involved in getting project approved for construction; including the submittal of project through the various agencies of relevance.

The Consultant shall also prepare an estimated time schedule for the design and construction phases of the project.

The Consultant will present the final site plan, feature plans, outline specifications, cost estimate, and schedule to the District. Consultant should expect some revisions and to resubmit the documents once. Final approval will be given to the Consultant by the District in writing.

The Consultant should anticipate two (2) meetings for this portion of the project.

3. Construction Documents

The construction documents shall be prepared to industry standards and State and local codes, and shall include drawings and specifications. They shall contain all required site plans, utility site plans, plans, profiles, sections and details to describe the work clearly and completely and reference the work to applicable standards and codes.

The contents of the construction documents are to be satisfactory to all governing agencies from who approvals are needed. **Submitting drawings and securing approvals from all governing agencies will be the responsibility of the Consultant.**

Identification of all governing agencies having jurisdiction over the project, and applying to them for permits, will be the responsibility of the Consultant. The Consultant shall communicate with all governing agencies in the early stages of the project so the Consultant can determine all requirements relating to the project. The Consultant will alert the District of the requirement for any lengthy and/or expensive reports and studies, well in advance of the need for their completion, so that the schedule and funding impact may be understood, clearly, by the District early in the project.

Complete construction documents shall have all necessary government agency approvals and will be ready to bid.

Once the construction documents are complete they shall be delivered to the District per "4". Miscellaneous Provisions" below.

4. Miscellaneous Provisions

The Consultant shall provide four (4) full-sized sets of signed, and sealed, bond copies of the 100% complete construction drawings and one (1) electronic copy of the construction drawings on a compact disc in AutoCAD 2010 (or compatible computer-aided drafting software) and PDF Professional to the District. The Consultant shall also supply electronic files of construction drawings to the District designated reproduction company. The District will bear reproduction costs for additional sets for District use thereafter.

Technical specifications shall be provided by the Consultant. A sample of District format follows as "Exhibit 2". Font style, font size and format of specifications shall conform to the District sample "Exhibit 2".

The District will provide the Consultant with an electronic version of its front-end bid documents and the General Conditions.

Four (4) hard copies of the technical specifications shall be submitted to the District, along with two (2) electronic copies (one each in Microsoft Word 2010 and PDF) on a compact disc. The consultant shall supply electronic files of the technical specifications to the District designated reproduction company. The District will bear reproduction costs thereafter for further copies of specifications for District use.

B. Bidding and Construction Administration Services: (N/A THIS PROJECT)

During the bidding phase, the CONSULTANT shall be available to furnish clarifications, details, consultation, and advice to the DISTRICT to ensure proper bidding of the project. In addition, the CONSULTANT shall attend the "Pre-Bid" conference with the contractors.

The CONSULTANT shall attend the bid opening, review all bids and make a recommendation to the DISTRICT regarding the lowest responsible bidder.

During the course of construction, the CONSULTANT shall be available to furnish plan clarifications, details, and consultation to the DISTRICT, and shall review and approve shop drawings/submissions. The CONSULTANT shall provide advice to the County to ensure proper completion of all work.

The CONSULTANT shall attend the "pre-construction" conference. The CONSULTANT shall make inspections as requested by the DISTRICT, but no more than once per week.

3. NOT-TO-EXCEED FEES:

A not-to-exceed fee is interpreted as the ceiling given on a project where hourly fees will be assessed, but only up to the not-to-exceed amount. If further work is needed or requested by the DISTRICT, written approval to go over the not-to-exceed figure must be given by the DISTRICT. The not-to-exceed figure is the CONSULTANT's best, educated estimate of what a project should cost. It is used by the DISTRICT for budgetary purposes.

Additional fee will be approved only when the CONSULTANT demonstrates that the scope of work for a project has been enlarged beyond what was originally described in the original project scope.

All printing costs and other costs associated with advertising the project for construction bids will be paid by the DISTRICT.

4. EXTRA WORK

Extra work shall be performed only when requested or approved by the DISTRICT in advance and in writing. The CONSULTANT will provide an estimated cost of the extra services before agreement is signed by the CONSULTANT and the DISTRICT. Extra work shall include, but not be limited to:

- A. Making special surveys and special analysis of the DISTRICT's needs to clarify requirements of the project when requested by the DISTRICT.
- B. Making measured drawings of existing construction when required for planning additional construction.
- C. Revising drawings and specifications previously approved by the Board of Directors.
- D. Consultation concerning replacement of any work damaged by fire or other cause during construction and furnishing professional services as may be required in connection with the replacement of such work.
- E. Arranging for the work to proceed should the CONSULTANT default due to delinquency or insolvency.
- F. Making an inspection of the project prior to expiration of the guarantee period and reporting observed discrepancies under guarantees provided by the construction contracts, if requested by the DISTRICT.
- G. Preparing plans or specifications for correction of defects of construction discovered after completion, or letting contracts of supervising construction for such correction; preparing for or participating in litigation arising out of the construction contract or defects of construction, whether before or after completion; or the enforcement of guarantees or warranties, so long as this is not the responsibility of the CONSULTANT.

III. CONSULTANT'S COMPENSATION

A. Determination of Amount

1. For the services described above, the DISTRICT shall pay to the CONSULTANT, the fees described in Exhibit A as full payment for all services under this Agreement, including all costs or expenses incurred by the CONSULTANT.
2. For extra work performed by the CONSULTANT, the DISTRICT shall pay to the CONSULTANT according to the hourly rates submitted by the CONSULTANT in response to the RFQ Proposal Fee Form, provided that the performance of said extra work has been requested and approved by the DISTRICT in writing, and after receipt of a written estimate from the CONSULTANT.
3. The CONSULTANT shall be responsible for all its costs and expenses related to the performance of its service under this Agreement.

B. Payment

1. **Not-To-Exceed Fees:**
The DISTRICT shall pay the CONSULTANT, upon submission of an invoice, monthly, and per the negotiated fee after the performance of the work. The extent of the services completed by the CONSULTANT will be verified by the DISTRICT prior to processing any payment.

IV. DUTIES OF CONSULTANT

- A. The CONSULTANT's services shall be performed in such a manner and form that will secure approval of any local, state or federal agency having jurisdiction over the work. The CONSULTANT is responsible to procure all agency approvals. The CONSULTANT shall furnish all engineering information and data necessary to meet the requirements of such agencies and as needed by the DISTRICT to secure financing.
- B. The CONSULTANT shall employ or engage all sub-consultants or other persons necessary to enable the CONSULTANT to perform the services under this Agreement, and the CONSULTANT shall be responsible for their compensation.
- C. The CONSULTANT shall obtain and maintain during the term of performance of this Agreement such Worker's Compensation insurance as required by law.
- D. The CONSULTANT shall pay a licensed geotechnical and soils testing firm to perform all necessary soils testing and furnish the DISTRICT with a copy of the soils testing results.
- E. The CONSULTANT shall obtain and maintain insurance as follows:

Without limiting or diminishing the CONSULTANT'S obligation to indemnify or hold the DISTRICT harmless, CONSULTANT shall procure and maintain or cause to be maintained, at its sole cost and expense, the following insurance coverages during the term of this Agreement.

1. Workers' Compensation:

If the CONSULTANT has employees as defined by the State of California, the CONSULTANT shall maintain statutory Workers' Compensation Insurance (Coverage A) as prescribed by the laws of the State of California. Policy shall include Employers' Liability (Coverage B) including Occupational Disease with limits not less than \$1,000,000 per person per accident. The policy shall be endorsed to waive subrogation in favor of the DISTRICT, and, if applicable, to provide a Borrowed Servant/Alternate Employer Endorsement.

2. Commercial General Liability:

Commercial General Liability insurance coverage including, but not limited to, premises liability, contractual liability, products and completed operations liability, personal and advertising injury, and cross liability coverage, covering claims which may arise from or out of CONSULTANT's performance of its obligations hereunder. Policy shall name the DISTRICT and the County of Riverside, its Agencies, Districts, Special Districts, and Departments, their respective directors, officers, Board of Supervisors, Board of Directors, employees, elected or appointed officials, agents or representatives as Additional Insureds. Policy's limit of liability shall not be less than \$1,000,000 per occurrence combined single limit. If such insurance contains a general aggregate limit, it shall apply separately to this agreement or be no less than two (2) times the occurrence limit.

3. Vehicle Liability:

If vehicles or mobile equipment are used in the performance of the obligations under this Agreement, then CONSULTANT shall maintain liability insurance for all owned, non-owned or hired vehicles so used in an amount not less than \$1,000,000 per occurrence combined single limit. If such insurance contains a general aggregate limit, it shall apply separately to this agreement or be no less than two (2) times the occurrence limit. Policy shall name the DISTRICT and the County of Riverside, its Agencies, Districts, Special Districts, and Departments, their respective directors, officers, Board of Supervisors, Board of Directors, employees, elected or appointed officials, agents or representatives as Additional Insureds.

4. Professional Liability Insurance:

CONSULTANT shall maintain Professional Liability Insurance providing coverage for the CONSULTANT's performance of work included within this Agreement, with a limit of liability of not less than \$1,000,000 per occurrence and \$1,000,000 annual aggregate. If CONSULTANT's Professional Liability Insurance is written on a claims made basis rather than an occurrence basis, such insurance shall continue through the term of this Agreement and CONSULTANT shall purchase at his sole expense either: 1) an Extended Reporting Endorsement (also known as Tail Coverage); or 2) Prior Dates Coverage from new insurer with a retroactive date back to the date of, or prior to, the inception of this Agreement; or 3) demonstrate through Certificates of Insurance that CONSULTANT has maintained continuous coverage with the same or original insurer. Coverage provided under items; 1), 2) or 3) will continue for a period of five (5) years beyond the termination of this Agreement.

F. General Insurance Provisions - All lines:

1. Any insurance carrier providing insurance coverage hereunder shall be admitted to the State of California and have an A M BEST rating of not less than A: VIII (A:8) unless such requirements are waived, in writing, by the County's Risk Manager. If the County's Risk Manager waives a requirement for a particular insurer such waiver is only valid for that specific insurer and only for one (1) policy term.

2. The CONSULTANT's insurance carrier(s) must declare its insurance self-insured retentions. If such self-insured retentions exceed \$500,000 per occurrence such retentions shall have the prior written consent of the County's Risk Manager before the commencement of operations under this Agreement. Upon notification of self insured retention unacceptable to the DISTRICT, and at the election of the County's Risk Manager, CONSULTANT's carriers shall either: 1) reduce or eliminate such self-insured retention as respects this Agreement with the DISTRICT; or 2) procure a bond which guarantees payment of losses and related investigations, claims administration, and defense costs and expenses.
3. CONSULTANT shall cause CONSULTANT's insurance carrier(s) to furnish the DISTRICT with either 1) a properly executed original Certificate(s) of Insurance and certified original copies of Endorsements effecting coverage as required herein, and 2) if requested to do so orally or in writing by the County's Risk Manager, provide original Certified copies of policies including all Endorsements and all attachments thereto, showing such insurance is in full force and effect.

Further, said Certificate(s) and policies of insurance shall contain the covenant of the insurance carrier(s) that thirty (30) days written notice shall be given to the DISTRICT prior to any material modification, cancellation, expiration or reduction in coverage of such insurance. In the event of a material modification, cancellation, expiration, or reduction in coverage, this Agreement shall terminate forthwith, unless the DISTRICT receives, prior to such effective date, another properly executed original Certificate of Insurance and original copies of endorsements or certified original policies, including all endorsements and attachments thereto evidencing coverages set forth herein and the insurance required herein is in full force and effect. *CONSULTANT shall not commence operations until the DISTRICT has been furnished original Certificate(s) of Insurance and certified original copies of endorsements and if requested, certified original policies of insurance including all endorsements and any and all other attachments as required in this Section. An individual authorized by the insurance carrier to do so on its behalf shall sign the original endorsements for each policy and the Certificate of Insurance.*

4. It is understood and agreed to by the parties hereto that the CONSULTANT's insurance shall be construed as primary insurance, and the DISTRICT or the County's insurance and/or deductibles and/or self-insured retention's or self-insured programs shall not be construed as contributory.
5. If, during the term of this Agreement or any extension thereof, there is a material change in the scope of services; or, there is a material change in the equipment to be used in the performance of the scope of work which will add additional exposures (such as the use of aircraft, watercraft, cranes, etc.); or, the term of this Agreement, including any extensions thereof, exceeds five (5) years the DISTRICT reserves the right to adjust the types of insurance required under this Agreement and the monetary limits of liability for the insurance coverages currently required herein; if, in the County's Risk Manager's reasonable judgment, the amount or type of insurance carried by the CONSULTANT has become inadequate.
6. CONSULTANT shall pass down the insurance obligations contained herein to all tiers of subconsultants working under this Agreement.
7. The insurance requirements contained in this Agreement may be met with a program(s) of self-insurance acceptable to the DISTRICT.

8. CONSULTANT agrees to notify DISTRICT of any claim by a third party or any incident or event that may give rise to a claim arising from the performance of this Agreement.

V. DUTIES OF THE DISTRICT

- A. The DISTRICT shall make available to the CONSULTANT all pertinent information which it has relating to the purpose and use of the project.
- B. The DISTRICT shall furnish the CONSULTANT with the most recent topographic survey of the property. The CONSULTANT will complete additional survey work as necessary.
- C. The DISTRICT shall pay a licensed testing and abatement contractor to test for hazardous materials and abate them as necessary upon request of CONSULTANT.
- D. The DISTRICT shall pay all plan check fees required by any local, state or federal agency. The DISTRICT shall also pay all required permitting fees for any local, state or federal agency.
- E. The DISTRICT shall promptly consider and act upon written requests or recommendations of the CONSULTANT including requests for information or services needed by the CONSULTANT to proceed with the Work.

VI. DOCUMENTS

All completed documents, including but not limited to plans and specifications, prepared by the CONSULTANT shall be the property of the DISTRICT.

The CONSULTANT shall provide four (4) full-sized sets of signed, and sealed, bond copies of the 100% complete construction drawings and one (1) electronic copy of the construction drawings on a compact disc in AutoCAD 2010, or compatible computer-aided drafting software, to the DISTRICT. The CONSULTANT shall also supply electronic files of the construction drawings to the DISTRICT designated reproduction company. The DISTRICT will bear reproduction costs for additional sets for DISTRICT use thereafter.

Technical specifications shall be provided by the CONSULTANT in Microsoft Word in the format determined by the DISTRICT in the RFQ.

The DISTRICT will provide electronic copies of its front end bid documents and the General Conditions.

Four (4) hard copies of the technical specifications shall be submitted to the DISTRICT and one (1) electronic copy on a compact disc. The CONSULTANT shall supply electronic files of the technical specifications to the DISTRICT designated reproduction company. The DISTRICT will bear reproduction costs thereafter for further copies of specifications for DISTRICT use.

VIII. LIABILITY AND INDEMNIFICATION

The CONSULTANT agrees to and shall indemnify and hold harmless the DISTRICT, County of Riverside, its Agencies, Departments, Districts and Special Districts, their respective directors, officers, Board of Supervisors, elected and appointed officials, employees, agents and representatives (hereinafter individually and collectively referred to as "Indemnitees") from:

- A. All liability, including, but not limited to loss, suits, claims, demands, actions, or proceedings to the

extent caused by any alleged or actual negligence, recklessness, willful misconduct, error or omission of CONSULTANT, its directors, officers, partners, employees, agents or representatives or any person or organization for whom CONSULTANT is responsible, arising out of or from the performance of professional services under this Agreement; and

- B. All liability, including but not limited to, loss, suits, damage, claims and demands, based upon any alleged or actual act, error, omission, or occurrence of CONSULTANT, its directors, officers, partners, employees, agents or representatives or any person or organization for whom CONSULTANT is responsible, arising out of, in connection with, resulting from conditions created by CONSULTANT, or caused by the CONSULTANT's performance or failure of performance of any work or services, other than professional services covered under Section 'A' above, under this Agreement.

As respects each and every indemnification herein CONSULTANT shall defend and pay, at its sole expense, all costs and fees including but not limited to attorney fees, cost of investigation, and defense and settlements or awards against the Indemnities.

With respect to any action or claim subject to indemnification herein by CONSULTANT, CONSULTANT shall, at their sole cost, have the right to use counsel of their own choice and shall have the right to adjust, settle, or compromise any such action or claim without the prior consent of COUNTY; provided, however, that any such adjustment, settlement or compromise in no manner whatsoever limits or circumscribes CONSULTANT's indemnification to Indemnities as set forth herein.

CONSULTANT's obligation hereunder shall be satisfied when CONSULTANT has provided to Indemnities the appropriate form of dismissal relieving Indemnities from any liability for the action or claim involved.

The specified insurance limits required in this Agreement shall in no way limit or circumscribe Contractor's obligations to indemnify and hold harmless Indemnities from third party claims.

In the event there is conflict between this clause and California Civil Code Section 2782, this clause shall be interpreted to comply with Civil Code 2782. Such interpretation shall not relieve the CONSULTANT from indemnifying the DISTRICT or the County to the fullest extent allowed by law.

IX. TERMINATION

Either party may terminate and cancel this Agreement for cause, after fifteen (15) days written notice to the other, for substantial breach of this Agreement or unreasonable delay in the performance of any obligation under this Agreement.

Notwithstanding the foregoing provision, the DISTRICT shall have the right upon completion of any phase of the CONSULTANT's service, or at any time if the DISTRICT decided to suspend or abandon the project, to terminate this Agreement upon written notice to that effect given to the CONSULTANT.

If the termination as herein provided is for other than default or delay of the CONSULTANT, the CONSULTANT shall be paid pursuant to this Agreement for its service on each completed section, and for any section in such proportion as the service actually performed bears to the total service which would be required for the completion of such section and no further compensation shall be paid to the CONSULTANT. If the termination is for default or delay of the CONSULTANT, it shall be paid on a similar basis less actual damages suffered by the DISTRICT as a result.



X. MISCELLANEOUS PROVISIONS

- A. Section and Sub-Section Approvals: Written approval by the DISTRICT for any phase of the CONSULTANT's services under this Agreement shall be considered as authorization to the CONSULTANT to proceed with the next successive phase, unless the DISTRICT otherwise specifies.
- B. Project Segregation: Unless otherwise required by the DISTRICT prior to the commencement of services, the drawings, specifications and other documents shall be prepared so that all of the Work on the project may be executed under a single construction contract.

If the DISTRICT and the CONSULTANT decide to phase the project or have additive or deductive alternates, reasonably segregatable portions of the project will be identified as alternates or for omission from the Work. In that event the CONSULTANT shall not be entitled to any extra compensation for such service.

If the decision to phase the project or have additive or deductive alternates occurs after the commencement of services, the CONSULTANT will be entitled to extra compensation. The amount will be based on the actual amount of work completed when the decision was made and will be agreed to by both the DISTRICT and the CONSULTANT.

In the event that phasing or alternates are used and separate construction contracts will be needed or additional work on the part of the CONSULTANT is needed, the DISTRICT and the CONSULTANT shall, in writing, agree in advance of the performance of this work on the nature and extent thereof and the amount of additional compensation, if any, to be paid to the CONSULTANT.

- C. Assignment: This Agreement shall not be assignable, in full or in part, by the CONSULTANT without prior written consent of the DISTRICT.
- D. DISTRICT's Representative: The General Manager of the DISTRICT, 4600 Crestmore Road, Jurupa Valley, CA 92509, or designee, shall represent the DISTRICT in all discussions and/or conferences with the CONSULTANT and other County departments and agencies not requiring the actions of the DISTRICT's governing body. A written summary of conclusions reached at any such conference may be required of the CONSULTANT by the DISTRICT's representative.
- E. Notices: Any notice or communication under this Agreement shall be transmitted to the parties at the addresses shown under the signature lines of this Agreement.
- F. Mediations: Any claim, dispute or other matter in question arising out of, or related to, this Agreement shall be subject to mediation prior to the institution of legal or equitable proceedings by either party.
- G. Release of Information to the Public: The CONSULTANT shall consider all information regarding the proposed project as confidential information. Any request for information from others shall be directed to the DISTRICT. This provision shall not apply if maintaining confidentiality would violate the law; create the risk of significant harm to the public; prevent the CONSULTANT from establishing or defending a claim.
- H. Time of Completion: The contract duration for design services will be one hundred seventy (170) calendar days. The CONSULTANT shall commence work within fifteen (15) calendar days after its

receipt of the Notice to Proceed. The design duration includes the submission of documents to all agencies and receiving approval from these agencies. CONSULTANT must identify which agencies will be involved, what their concerns are and determine how to address these issues as expeditiously as possible. Completion of this portion of the project is expected in December, 2013.

The CONSULTANT acknowledges and accepts the DISTRICT's schedule. The CONSULTANT and the DISTRICT shall establish milestones for all portions of the work. The mutually established dates shall be firmly maintained. The CONSULTANT shall confirm and update schedules as necessary and as described in the RFQ.

- I. Governing Law: This Agreement shall be governed by the laws of the State of California. Any legal action related to the performance of interpretation of this Agreement shall be filed only in the Superior Court for the State of California located in Riverside, California. Should action be brought to enforce or interpret the provisions of the Agreement, the prevailing party shall be entitled to attorney's fees in addition to whatever other relief are granted.
- J. Independent Consultant: The CONSULTANT is, for purposes arising out of this contract, an independent contractor and shall not be deemed an employee of the DISTRICT. It is expressly understood and agreed that the CONSULTANT shall in no event, as a result of this contract, be entitled to any benefits to which DISTRICT employees are entitled, including but not limited to overtime, any retirement benefits, worker's compensation benefits, and injury leave or other leave benefits. CONSULTANT hereby holds DISTRICT harmless from any and all claims that may be made against DISTRICT based upon any contention by any third party that an employer-employee relationship exists by reason of this agreement. It is further understood and agreed by the parties hereto that CONSULTANT in the performance of its obligation hereunder is subject to the control or direction of DISTRICT merely as to the result to be accomplished by the services hereunder agreed to be rendered and performed and not as to the means and methods for accomplishing the results.
- K. Compliance: The CONSULTANT warrants and certifies that, in the performance of this Agreement, it shall comply with all applicable laws, rules, regulations and orders of the United States, the State of California, and the County of Riverside, including the laws and regulations pertaining to labor, wages, hours and other conditions of employment. The CONSULTANT further warrants and certifies that it shall comply with new, amended, or revised laws, regulations and/or procedures that apply to the performance of this Agreement.
- L. Severability: If any provision in this Agreement is held by a court of competent jurisdiction to be invalid, void or unenforceable, the remaining provisions will nevertheless continue in full force without being impaired or invalidated in any way.

This Agreement constitutes the entire agreement between the parties hereto with respect to the subject matter hereof and all prior or contemporaneous agreements of any kind or nature relating to the same shall deem to be merged herein. Any modifications to the terms of this Agreement shall be in writing and incorporated herein and no oral understanding or agreement not incorporated herein shall be binding on any of the parties hereto.

XI. GENERAL

This Agreement, including any attachments or exhibits, constitutes the entire Agreement of the parties with respect to its subject matter and supersedes all prior and contemporaneous representations, proposals, discussions and communications, whether oral or in writing. This Agreement may be changed or modified only by a written amendment signed by authorized representatives of both parties.

BOARD OF DIRECTORS

COUNTY OF RIVERSIDE
RIVERSIDE COUNTY REGIONAL PARK
AND OPEN-SPACE DISTRICT
4600 Crestmore Road
Jurupa Valley, CA 92509

Signature: 

Print Name: KEVIN JEFFRIES

Title: Chairman

Dated: SEP 24 2013

CONSULTANT

KTU+A PLANNING & LANDSCAPE
ARCHITECTURE
3916 Normal Street
San Diego, CA 92103

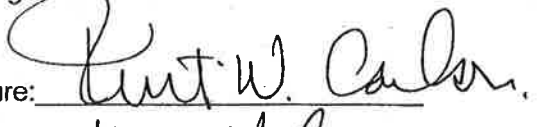
Signature: 

Print Name: KURT W. CARLSON

Title: PRINCIPAL, CORP. SECRETARY

Dated: SEPT. 11, 2013

ATTEST:

KECIA HARPER-IHEM, Clerk of the Board

By: 
Deputy

Dated: SEP 24 2013

APPROVED AS TO FORM COUNTY COUNSEL:

PAMELA J. WALLS, County Counsel

By: 

Dated: 9-12-13



Exhibit A

PROPOSAL FEE FORM

Item	Proposal Price
A. Design and Engineering Services	
1. Survey Work and Calculations	\$ <u>19,240</u>
2. Design	\$ <u>100,218</u>
B. Construction Documents	
1. Drawings	\$ <u>90,315</u>
2. Technical Specifications	\$ <u>4,860</u>
3. Cost Estimation	\$ <u>7,320</u>
4. Environmental	\$ <u>44,955</u>
C. Geotechnical Work	\$ <u>40,950</u>
D. Bidding & Construction Admin Services	\$ <u>N/A</u>
TOTAL BASE COST FOR THIS PROJECT	\$ <u>307,858</u> (In Numbers)

Three Hundred Seven Thousand Eight Hundred Fifty Eight and 00/100 Dollars
(In Words)

E. Additive Alternates (If Needed)	
1. Additional Survey Work	\$ <u>3,500</u>
2. Irrigation Plans	\$ <u>63,358</u>
3. Planting Plans	\$ <u>53,453</u>

Consultant shall attach an hourly rate sheet to this form for use for extra services, if there is a need.

KTU+A

Principal	\$165.00
Senior Associate.....	\$135.00
Associate.....	\$115.00
Senior Designer/Senior Planner/GIS Analyst ..	\$105.00
Designer/Planner	\$95.00
Administration.....	\$75.00

RBF Consulting

Senior Principal	\$275.00
Principal	\$250.00
Project Director	\$225.00
Program Manager	\$215.00
Senior Project Manager	\$200.00
Project Manager	\$195.00
Structural Engineer	\$195.00
Technical Manager	\$180.00
Senior Engineer	\$163.00
Senior Planner	\$163.00
Electrical Engineer	\$163.00
Landscape Architect.....	\$150.00
Senior GIS Analyst	\$150.00
Project Engineer	\$148.00
Project Planner	\$148.00
Survey Crew Support Manager	\$145.00
Environmental Specialist	\$138.00
Design Engineer/Senior Designer/Mapper	\$135.00
GIS Analyst	\$122.00
Designer/Planner	\$118.00
Project Coordinator	\$110.00
Graphic Artist	\$97.00
Environmental Analyst/Staff Planner	\$ 97.00
Design Technician	\$97.00
Assistant Engineer/Planner.....	\$ 93.00
Permit Processor	\$83.00
Engineering Aid/Planning Aid	\$75.00
Office Support/ Clerical	\$ 63.00

FIELD PERSONNEL

2-Person Survey Crew.....	\$250.00
1-Person Survey Crew	\$165.00
Licensed Surveyor.....	\$175.00
Field Supervisor	\$175.00

FirstCarbon Solutions - Michael Brandman Associates

Senior Project Manager/Senior Scientist	\$110-180
Project Manager/Regulatory Scientist.....	100-150
Assistant Project Manager	80-120
Environmental Planner/Ecologist/Biologist.....	70-95
Environmental Analyst/Regulatory Analyst.....	60-90
Research Analyst/Staff Ecologist.....	50-75
Senior Archaeologist/Paleontologist	95-135
Project Archaeologist/Paleontologist	85-110
Project Coordinator	65-90
Architectural Historian/Staff Archaeologist.....	65-95
Field Director/Crew Chief/Supervisor	65-80
Laboratory Director	65-80
Field Monitors/Laborer.....	40-55
Laboratory Assistant	40-55
Publications Coordinator/Technical Editor	90-115
GIS Analyst.....	70-130
Graphics Designer/GIS Technician	65-80
Word Processor	65-80
Administrative Assistant/Clerical.....	55-80
Reprographics Assistant/Intern.....	45-60

Geocon

Principal Engineer/Geologist	\$195.00
Associate Engineer/Geologist.....	\$175.00
Senior Engineer/Geologist.....	\$140.00
Senior Project Engineer/Geologist.....	\$125.00
Project Engineer/Geologist	\$115.00
Senior Staff Engineer/Geologist.....	\$105.00
Staff Engineer/Geologist	\$95.00
Engineering Field Technician	\$70.00
Engineering Assistant/Lab Technician.....	\$60.00
Word Processor/Non-Technical Assistant	\$60.00

Request for Qualifications for Design, Engineering, and Environmental Services for the Salt Creek Trail

PKARC - 140

CERTIFICATION ACKNOWLEDGEMENT

I, Kurt Carlson, a duly authorized agent of KTU&A

Printed Name of Agent/Officer

Name of Firm/Organization/Consortium

Hereby certify that KTU&A

Name of Firm/Organization/Consortium

by submission of this SOQ in response to PKARC-140 Design, Engineering and Environmental Services for the Salt Creek Trail acknowledge receipt of Addendum # 1 AND has performed all necessary site visits required to submit a complete SOQ.

(List Addendums)

Signature Kurt W. Carlson

Date 5/9/2013

Title of Agent/Officer Principal/Secretary

Exhibit B

Statement of Qualifications and Proposal



Salt Creek Trail Design, Engineering and Environmental Consulting Services

Riverside County Regional Park and Open-Space District

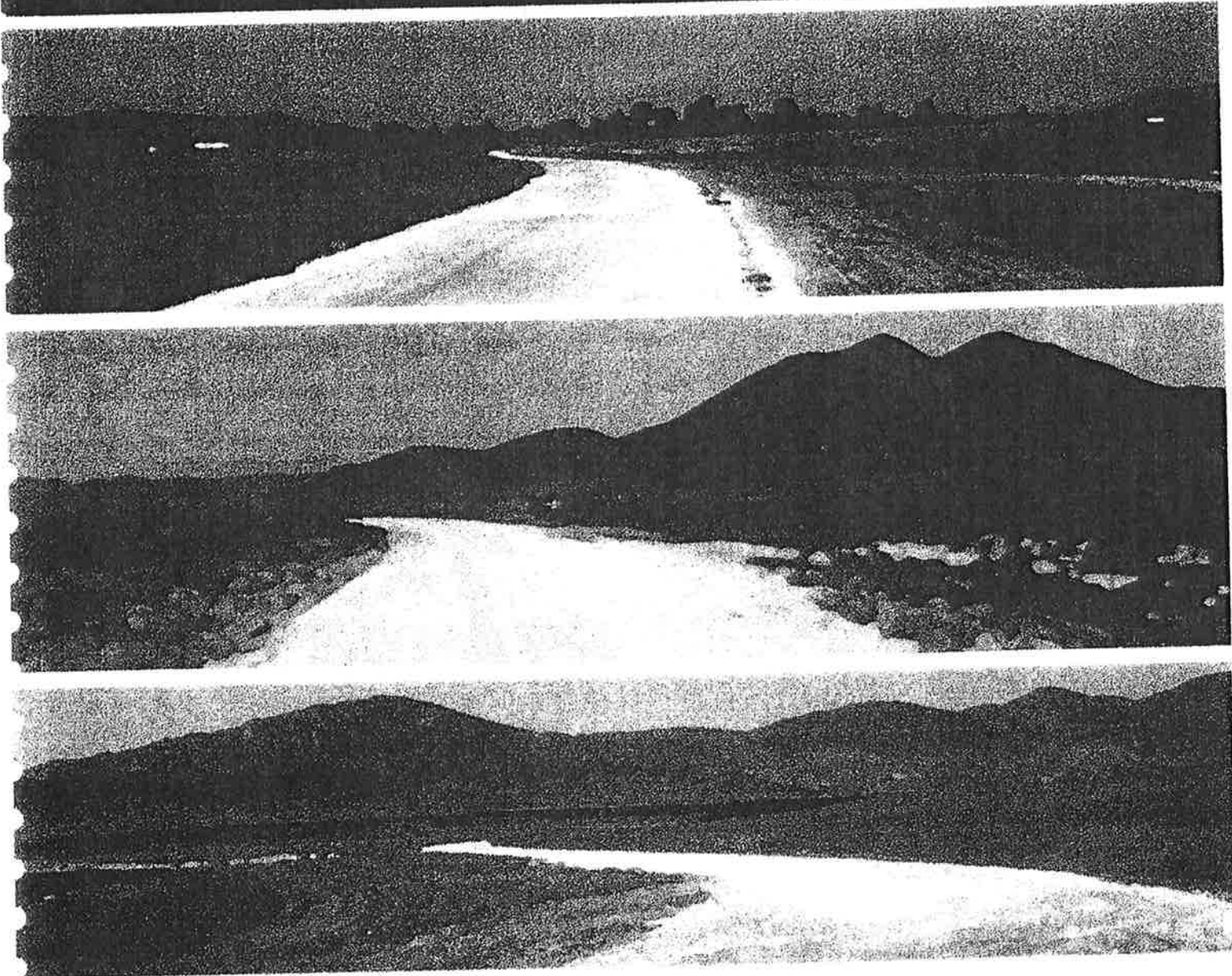

Planning + Landscape Architecture

3916 Normal Street
San Diego, CA 92103
619 294-4477
www.ktua.com
May 13, 2013

Principal:
Kurt Carlson, 619 294-4477 x105, kurt@ktua.com

Project Manager:
John Holloway, 619 294-4477 x133, john@ktua.com

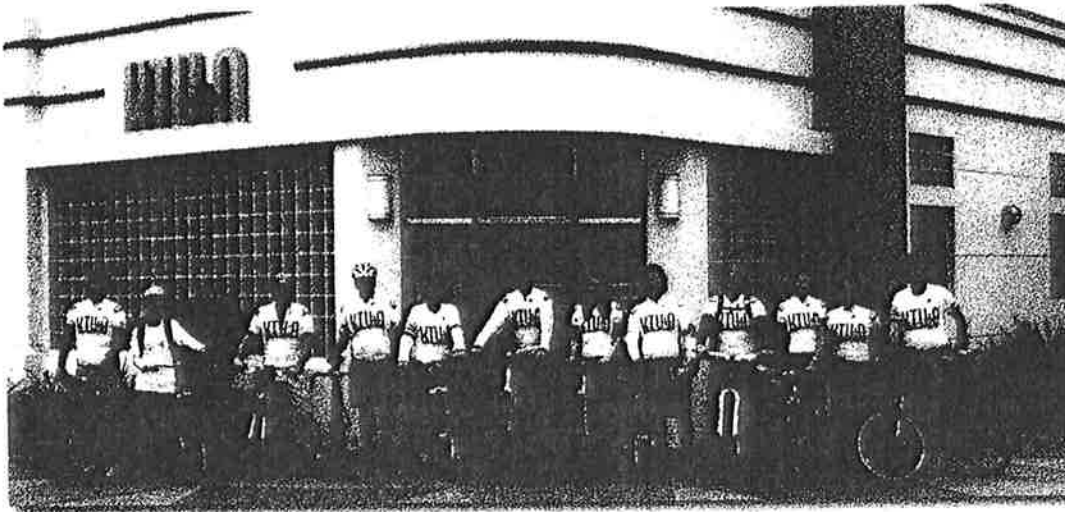

Winner of 2011 and 2012 SANDAG Small Business Bike-to-Work Day Challenge

Identification of Proposer

Legal Name:

KTU&A
3916 Normal Street, San Diego, CA 92103
t: 619 294-4477

Year Company Established: 1970

Personnel: 27

Organization Structure: California Corporation

Contact:

Principal
Kurt Carlson, PLA
t: 619 294-4477 x105
e: kurt@ktua.com

Project Manager

John Holloway, PLA, LEED GA, LCI
t: 619 294-4477 x133
e: john@ktua.com

- SOQ Cover Sheet 1
- Cover Letter 2
- KTU+A Profile 3
- Team Organization 4
- KTU+A Key Personnel Resumes 5
- KTU+A Project Experience 7
- RBF Consulting Qualifications 13
- RBF Consulting Key Personnel 14
- First Carbon Solutions Qualifications 16
- First Carbon Solutions Key Personnel 17
- Geocon Qualifications 19
- Geocon Key Personnel 19

Exhibit 1 Cost Proposal Under separate cover

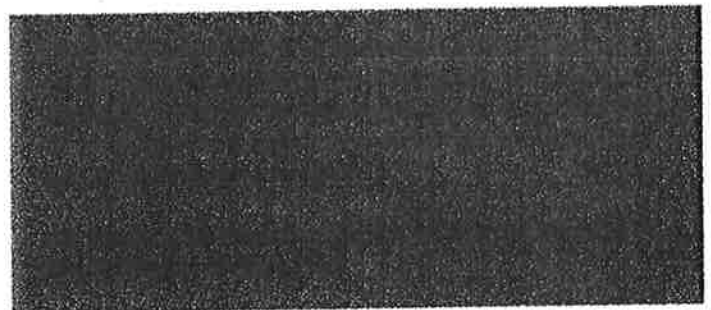

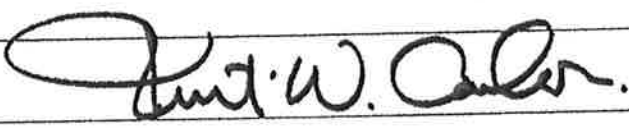
Firm name:	KTU&A
Firm address:	3916 Normal Street, San Diego, CA 92103
Phone:	619 294-4477
Fax:	619 294-9965
Email address:	Kurt Carlson, Principal Landscape Architect: kurt@ktua.com John Holloway, Project Manager: john@ktua.com
Type of Organization: (i.e. corporation, partnership, etc.)	California Corporation
Authorizing Agent:	Kurt Carlson
	(Name Printed)
	Principal
	(Title)
Professional Registration:	California Professional Landscape Architect 2342
Expiration Date:	February 2015
Signature:	
Date:	May 9, 2013
List Each Addendum Received:	Addendum 1: 4/30/2013 Addendum 1 Certification Cost Sheet Form Addendum 2: 5/10/13

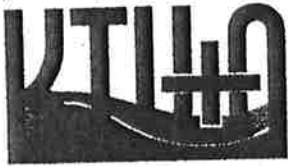

3916 Normal Street
San Diego, CA 92103
619.294.4477
fax • 619.294.9965
www.ktua.com
LLA 2343 • 2386 • 2500

May 9, 2013

Ms. Julie Smitth-Campbell
Riverside County Regional Park and Open-Space District
4600 Crestmore Road
Jurupa Valley, CA 92509

*A TRAIL,
an invitation,
a walk, a run, a hike,
a path that leads you,
a path that takes you away,
A TRAIL*

—L.L. BEAN

Dear Ms. Smith-Campbell and Members of the Consultant Selection Committee,

Recent studies confirm the strong connection between public health and the built environment. A safe, connected, convenient and visible network is the best method to encourage the use of alternative transportation modes and active recreation. Providing choices for how to get around, as well as opportunities for recreation, have become priorities for many communities. An increase in the number of people walking and biking for transportation and recreation has both qualitative and quantitative benefits. In addition to improved public health, an enhanced sense of place and community, and economic development, communities that construct recreational elements such as trails see improved traffic level of service, reduced greenhouse gas emissions, and less traffic and parking congestion.

The growing disconnect between nature and the built environment has given rise to the phenomenon of Nature Deficit Disorder, hindering the integration of man and nature. NDD is inhibiting childhood development with many children spending little time with nature. This makes trails that provide visual and physical access to natural areas especially important and valuable. Trails in resource rich areas like Riverside County provide access to nature and natural processes and are important to the welfare of our communities.

Our team combines the strength of KTU+A's trail planning and design with the technical expertise of RBF Consulting in civil and traffic engineering; FirstCarbon Solutions - Michael Brandman Associates in environmental planning and permitting; and Geocon in geotechnical engineering. Most of our team members have collaborated on other trail projects in southern California, including various segments of the Santa Ana River Trail.

In providing trail planning and design services, KTU+A has found that its client's needs are best met by helping them understand the public's interests. The challenges in designing trails, open spaces, and parks are successfully addressed when local officials, planners, residents, and community groups come together to create a balanced plan of infrastructure, community identity, site character, human activities, and nature.

I will be the principal-in-charge on this project, John Holloway will be the day-to-day project manager, and Tim Henderson will provide assistance on the design efforts. John and Tim are currently working on the Santa Ana River Trail project in conjunction with RBF Consulting and Riverside County Regional Park and Open-Space District. They are familiar with your design requirements.

We understand the challenges associated with a project of this magnitude. We also understand the need to prepare a plan that is well accepted by the residents, the community and all of the involved agencies, as well as the need to be cost effective to implement and maintain. By maintaining an open dialogue with the county and stakeholders, discussing proven, as well as innovative approaches, that may help overcome issues raised by the stakeholders, and working quickly to address areas of concern, we are confident that a comprehensive trail system can be constructed for Salt Creek.

Please let me know if I can answer any questions or provide any additional information. We look forward to meeting with you personally to detail our approach to your project and discuss how we can help move this project forward.

Respectfully submitted,

A handwritten signature in black ink that reads "Kurt W. Carlson". The signature is fluid and cursive.

Kurt Carlson, PLA
p: 619 294-4477 x105
e: kurt@ktua.com

PRINCIPALS

Sharon Singleton, ASLA, CPSM
 Sandra Swaner-Carmona, AICP
 Kurt Carlson, ASLA
 Mike Singleton, ASLA, AICP CTP,
 LEED-AP

EMPLOYEES - 27 (6 LEED)

9 Landscape Architects
 8 Planners
 4 Landscape Designers
 1 Irrigation Designers
 2 GIS Analysts
 1 Graphic Designer
 2 Administrators

CERTIFICATIONS

Woman Business Enterprise (CPUC)
 Small Business Enterprise (CA)

SERVICES**Planning**

- Community Planning
- Mobility
- Resource Management

Landscape Architecture

- Community Design
- Parks and Recreation
- Health Care
- Education
- Housing
- Hospitality
- Office and Retail

Federal Planning

- Master Plans
- MILCON Documentation
- Basic Facility Requirements
- Asset Evaluations
- Capital Improvement Plans
- Design Guidelines
- Special Studies

SUPPORT SERVICES

- Public Outreach
- GIS
- 3D Modeling and Simulations
- Sustainable Design
- Water Management
- Grant Writing

KTU+A is a collaboration of planners, landscape architects, GIS analysts, irrigation designers and graphic designers focused on the creation of healthy communities. Established in 1970, KTU+A has expanded the boundaries of a traditional landscape architecture office by incorporating active transportation, community planning, federal planning, and natural resource management practices into our portfolio. With this diversity, KTU+A has the ability to help shape the bigger picture while addressing the fine-grained details that contribute to sustainable natural and built environments.

How We Approach Your Project

The planning and design of a project requires an understanding of the regulations and requirements to protect the public's health, safety and welfare; an understanding of innovative design technologies to meet current and future needs; an understanding of the needs and priorities of the users; and an understanding of the responsibilities of the client in terms of risk management, maintenance, future expansion opportunities and costs. KTU+A takes these responsibilities seriously and collaborates with our clients and the consultant team to ensure the project meets and exceeds its goals and objectives.

The trends towards higher energy costs, lower oil production and more sustainable economic growth necessitate the need to provide better transportation plans that emphasize human mobility as part of the solution. Whether this is achieved through principles of smart growth, traffic calming, universal access, or pedestrian and bike facility integration with vehicular streets and open spaces, the technical challenges must be met. Our streets are not just for drivers. They should evolve into "complete streets" for the entire community. KTU+A offers a proven track record of cost-effective, technically proficient and creative approaches towards mobility that connects people, places and resources.

Project Experience

KTU+A has provided planning and design services for a number of projects requiring the integration of various modes of transportation, including pedestrian, bicycle, equestrian and transit. Services have included alignment alternatives, design feasibility, safety evaluation, determination of appropriate land uses, design guidelines development, integration with recreational, residential and commercial land uses, analysis and identification of bikeway and walkway locations, and ADA accessibility. Our qualifications include:

- All plans prepared by KTU+A comply with State, Federal Highway Administration, AASHTO and MUTCD standards.
- Experience in researching and recommending innovative facility treatments and programs for specific issues.
- GIS computer applications for producing alignment analysis, pedestrian and bicycle suitability modeling, maps, route selection, graphic production, estimating and 3-D visualizations.
- Expertise in pedestrian and bikeway planning and a commitment to the integration of recreation, land use planning, community design, urban design and non-motorized alternatives.
- Research on pedestrian and bicycle safety factors and common accident scenarios.
- Experience with the integration of trails systems within environmentally and visually sensitive areas.

Representative Projects

- Salinas River Trail Master Plan, San Luis Obispo County, CA
- Santa Ana River Trail, Riverside County, CA
- Santa Ana River Trail, Phase 4, San Bernardino County, CA
- Santa Ana River Parkway, Orange County, CA
- Murrieta Creek Trail, Temecula, CA
- San Dieguito River Park Coast to Crest Trail, San Diego, CA
- San Diego River Trail Gap Analysis, San Diego, CA

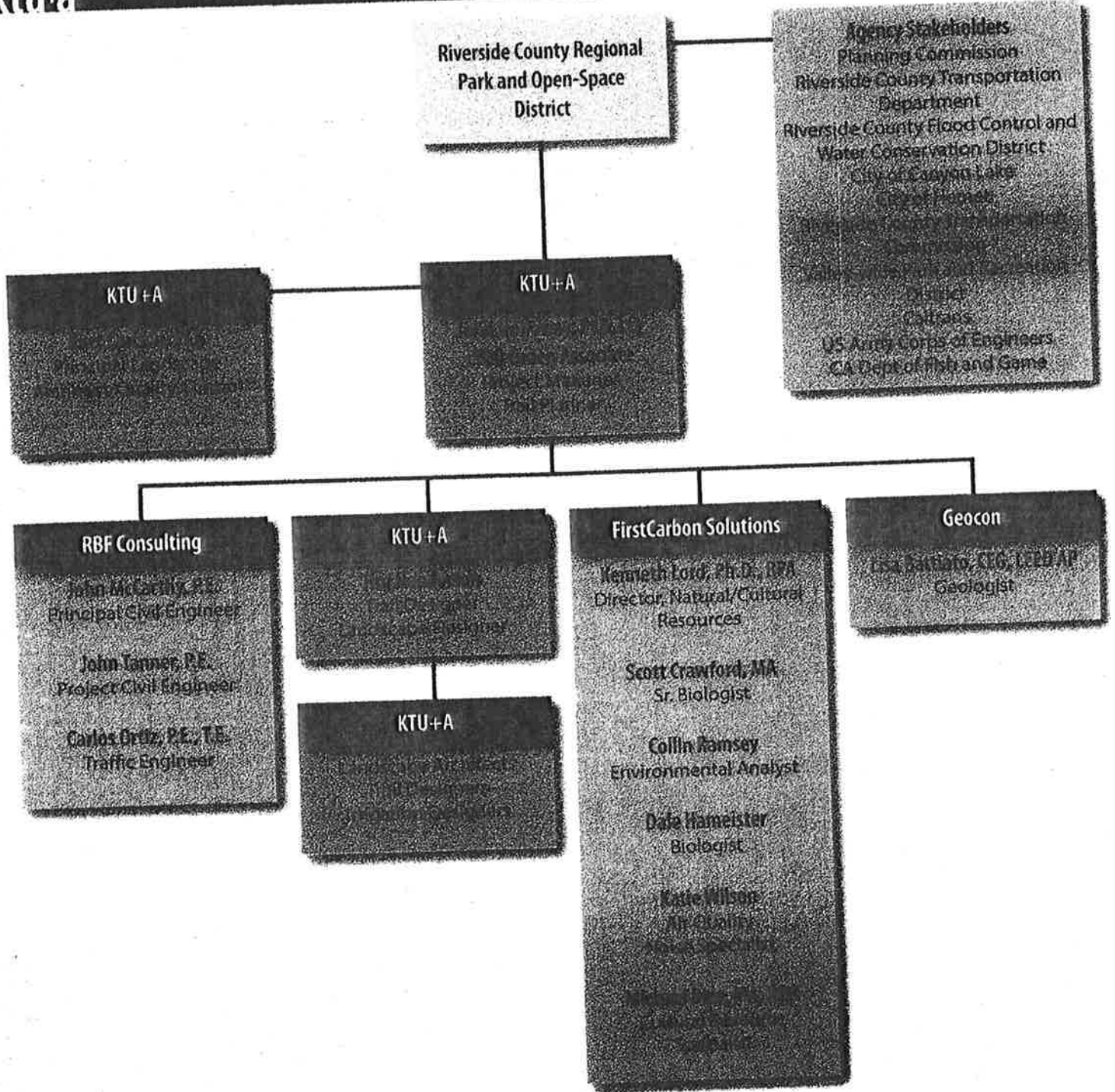

EDUCATION

- B.S. Landscape Architecture, California Polytechnic State University, San Luis Obispo, California, 1979

REGISTRATION

- 1983, State of California Landscape Architect PLA 2342

ORGANIZATIONS

- American Society of Landscape Architects
- California Park and Recreation Society

COMMUNITY

- Water Conservation Industry Work Group Co-Chair for the San Diego County Water Authority
- Carmel Mountain Ranch Community Planning Group
- ACE Mentorship Program

Kurt Carlson is a landscape architect and urban designer whose career at KTU+A spans over 30 years of experience throughout southern and central California. His focus is on place-making concepts and functional landscape designs. He has successfully completed many award-winning design projects in diverse markets of the public and private sector and enjoys the community participation process. His projects incorporate sustainable design, water conservation, and smart growth urban design principles.

Santa Ana River Trail, Phase 4, San Bernardino, CA

Principal landscape architect for the development of preliminary trail alignments for Phase Four of the Santa Ana River Trail. This trail will connect the planned Phase Three alignment through the Cities of Redlands, Mentone, Highlands and the County of San Bernardino to the existing Santa Ana River trail system. Using GIS and environmental data, the team developed a preferred alignment with multiple alternatives ranging from multi-use paths to bike routes on existing streets.

Valley Center Road and Heritage Trail, Valley Center, CA

Principal landscape architect for the preparation of a landscape master plan and construction documents for two miles of street improvements on Valley Center Road for the County of San Diego. Responsibilities included presentations at numerous community meetings and coordination with county staff, and the Valley Center Community Planning Group and Design Review Board. The project elements include native landscape, drip irrigation, and a heritage pedestrian/equestrian trail parallel to the roadway to provide linkages to the community.

Lakeview Park, Discovery Hills, San Marcos, CA

Project manager for conceptual plans and construction documents for a neighborhood park and trail system. The community involvement included design team meetings and collaboration with the City of San Marcos, including planning, engineering, public works and community services. KTU+A worked with the consulting biologist to protect the sensitive wetlands and vegetation. Park features include a disabled accessible water play fountain and amphitheater, picnic areas, and a playground. The park also includes Discovery Lake, surrounded by hiking and equestrian trails. A fishing dock located just off the hiking trail provides access to the lake.

Leo Carrillo Ranch Park, Carlsbad, CA

Project manager for the preparation of a master plan and construction documents for the City of Carlsbad. Responsible for the facilitation of public workshops, preparation of the master plan, coordination of multi-disciplinary subconsultant team, preparation of construction documents and construction administration. The project focuses on the historical, cultural and educational aspects of the area with some passive recreational uses, including a comprehensive trail system within the park site.

Sea World Trail, San Diego, CA

Principal landscape architect for the preparation of design development and construction document packages for the Sea World Trail. The trail provides a pedestrian connection between Sea World and the South Shores area of Mission Bay Park. Responsibilities included adherence to Mission Bay Park and City of San Diego Guidelines and Standards.

Colton Regional Park Master Plan, Colton, CA

Principal landscape architect for a master plan for a regional park along the banks of the Santa Ana River. The master plan assists the County of San Bernardino in determining community needs and to plan for future development. Prop 40 River Parkway Program funding was utilized for the master plan. Facilitated community workshops to identify park needs and evaluate master plan alternatives. Proposed improvements include sports fields, camping, fishing, trails, open space, native habitat restoration and interpretive centers.

EDUCATION

- Bachelor of Science in Biology, University of North Texas, Denton, Texas, 1982
- Master of Landscape Architecture, Texas A&M University, College Station, Texas, 1988

REGISTRATION

- State of California Landscape Architect, LLA 3734
- League of American Bicyclists Certified Instructor #2008
- LEED Green Associate

ORGANIZATIONS

- American Society of Landscape Architects
- Association of Pedestrian and Bicycle Professionals

COMMUNITY

- City of San Diego Open Space Canyons Advisory Committee
- City of San Diego Canyon Enhancement Committee
- San Diego Mountain Biking Association
- International Mountain Bicycling Association, California Regional Leadership Advisory Council
- San Diego Canyonlands, Technical Advisor

PRESENTATIONS

- California Trails and Greenways Conference, 2011, 2012; California Park & Recreation Society, 2012, *Technology for Designing Fun, Sustainable Trails*
- San Diego State University Urban Studies Program, *Bicycle Planning*, 2009

Combining his interest in cycling with his professional planning and design background, John Holloway offers both technical and functional expertise in the design of trail systems. Much of his recent volunteer work has been directed at developing antidotes to the decades-long reduction in outdoor activity and the resulting childhood obesity epidemic; especially attracting kids and their parents back to the outdoors with age-appropriate activities and facilities that appeal to their sense of fun and adventure.

Santa Ana River Trail, Riverside County, CA

Trail designer/landscape architect for paved bikeways and associated soft surface trails along Santa Ana River in southern Riverside County, a seven mile portion through the Prado Basin. Project role is to refine trail alignments and to design amenities and enhancements that minimize impacts to river-related habitat, wildlife corridors and flooding. Evaluating route alternatives involves significant field work and agency coordination. Project scope includes developing construction drawings for staging areas and oversight of overall design team's drawings to ensure positive user experience.

Santa Ana River Parkway, Orange County, CA

Trail planner for soft surface trail and paved bikeway alignments along Santa Ana River to complete Orange County's remaining portion of the 75-mile trail system. Project involved public and agency outreach to minimize impacts to the river, river-related habitat, wildlife corridors, flood control and other facilities, while maximizing trail user experience. The study identified existing and proposed connections to the Parkway, and evaluated potential connections proposed by adjacent counties and cities.

Santa Ana River Trails, Phase 4, San Bernardino County, CA

This trail will connect the planned Phase Three alignment through the cities of Redlands, Mentone, Highlands and the County of San Bernardino to the existing Santa Ana River trail system. Using GIS and environmental data, a preferred alignment with multiple alternatives ranging from multi-use paths to bike routes on existing streets has been identified. Critical to the implementation of the plan is the review and approval process through multiple local, regional, state and federal jurisdictions.

Coast to Crest Trail, San Dieguito Lagoon Segment, San Diego, CA

Responsible for the planning, design and layout of the four-mile segment of the Coast to Crest trail along the western segment of the San Dieguito River. Much of the trail lies within the San Onofre Nuclear Generating Plant Wetland Mitigation project and required floodway and habitat coordination with multiple agencies including the cities of San Diego and Del Mar, 22nd Agricultural District, Coastal Commission, Caltrans, CA Fish and Game, and US Fish and Wildlife. The project included stormwater treatment pond design as part of an educational and interpretive component, and utilized multiple trail types, including 1,100 feet of recycled plastic composite boardwalk.

Salinas River Corridor Anza Trail Master Plan, San Luis Obispo County, CA

Planner and project manager for analysis and alignment of a 35-mile trail system connecting several communities along the Salinas River in northern San Luis Obispo County. Trail is to provide access and recreational enjoyment and safety for pedestrians, cyclists and equestrians while respecting the environment and private property. The trail's connectivity and accessibility are intended to be a draw for both residents and tourists to provide economic benefits and an educational link to the Salinas River's habitat, history and culture.

Mockingbird Trail, Riverside, CA

Trail planner responsible for the identification and evaluation of potential multi-use trail alignments between two open space preserves in Riverside County. Existing land ownerships, environmental constraints, planned roadways and topography were issues addressed to determine how best to provide a true trail experience connecting the two open spaces. Project involved substantial field work along the 11-mile corridor and several alternatives were evaluated. Incorporated alignment selection criteria that emphasized maximizing user experience over all other considerations.

Salinas River Trail Alignment Ranking Criteria: Opportunities and Constraints

Importance	Highly Constrained	Constrained	Neutral	Moderate Opportunity	High Opportunity	
Based on Steering Comm	Areas to avoid / Fatal Flaws	Constrained with limited opportunities	Slightly constrained and having limited opportunities	Moderate opportunity for trail alignment	Greatest opportunity for trail alignment, ease of implementation	
Raw Score	0.5 to 2.0	-2	0	1	2	
Distance Factor			(1/2 - 1 mile)	(1/4 - 1/2 mile)	(\leq 1/4 mile)	
1. Proximity of Public Destinations	2.00		Regional shopping centers, grocery stores, elementary schools, public services, middle schools, transit stops, high schools and colleges, public parking, historical sites and recreational locations			
2. Proximity to Population Density (1)	1.50		0-5 persons per acre	5-10 persons per acre	> 10 persons per acre	
3. Existing Land Use	1.00	High Density Mixed-Use, Multi-Family Residential	Community Commercial, Industrial, Mixed Use, Office, Single-Family and Suburban Residential	Commercial Service, Neighborhood Commercial, Rural Residential	Agriculture, Regional Commercial, Rural Lands, Multi-Land Use (AG), Public Facilities	Open Space, Public Recreation, Transportation
4. Land Ownership	2.00	Private property (<1 acre)	Private property (1-4 acres)	Private property (>= 5 acres), Publicly owned lands by quasi-public agencies where primary use is not focused on public access	Publicly owned undeveloped lands, easements, developed ROW and large properties with development potential	Publicly owned dedicated open space, parkland, or undeveloped ROW
5. Cultural Resources	1.00	Important historic resources with 1/16 mile buffer	Sensitive resources with 1/16 mile buffer	Sensitive resources with 1/16 mile buffer	Unrecognized historical/nonsensitive points of interest	Recognized historical / non-sensitive points of interest
6. Wetland Vegetation Cover	3.00	Highly vegetated riparian wetland	Open wetland	Open bank-top wetland, highly vegetated riparian wetland	Wetland of moderate/low cover	Wetland with low cover
7. Flood Zone	1.50	Active Floodway Designated Determined by Flood Hazard Hydrologic, hydrologic, riparian vegetation and topographic slope	Zone A-F and A-B-A-see note 8. The nominal channel of the river. Floodway, usually in the form of a pond, with an average depth ranging from 1 to 3 feet.	Zone A-F areas with a 1% annual chance of flooding. Riparian wetland areas are not considered for high stream risk despite base flood elevation are shown within these areas	Zone A-F areas of flooding. SLOCOG only	Zone A-F areas of flooding. SLOCOG only. Areas with no flood hazard are not considered for high stream risk.
8. Slope (%)	1.25	>30%	12-30%	6-12% and <1%	5-6%	0-5%
9. Soil Slope (%)	0.75	High	High	High		Low
10. Hydric Soils	0.75	All hydric		Unknown hydric	Partially hydric	Not hydric
11. Geology (Landslide Risk)	1.00	Very high	High	Moderate	Low	None

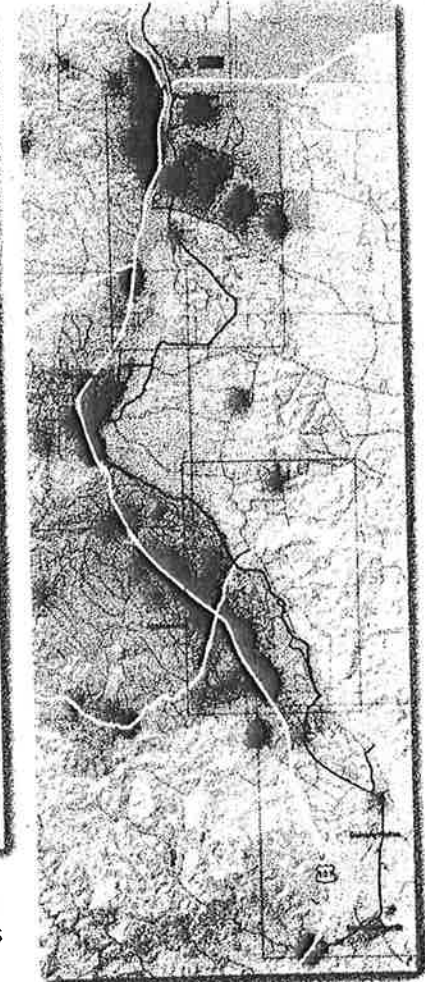

Client

San Luis Obispo Council of Governments
 Geiska Velasquez
 t: 805 788-2104
 e: gvelasquez@slocog.org

Location

San Luis Obispo, CA

Status

Ongoing 2013, 60% complete
 On schedule and within budget

Services

Trail Planning
 Public Outreach

KTU+A Key Personnel

Mike Singleton
 John Holloway
 Joe Punsalan

KTU+A Contract Value
 \$255,000

KTU+A is providing consultant services to the San Luis Obispo County Organization of Governments (SLOCOG) for trail planning, landscape architectural and environmental expertise in preparing a trails master plan through northern San Luis Obispo County along the Salinas River. The communities along the river approached SLOCOG about initiating and obtaining funding for the plan, which will provide connections over approximately 35 miles, much of it within the nationally designated historic Anza Trail corridor.

This master plan will define both feasible short-term and desirable long-term alignments. Plan tasks include assessing existing conditions, analyzing opportunities and constraints, developing design criteria, trail alignment alternatives, an implementation plan and extensive public input, including coordination with a steering committee with representatives from communities along the Salinas River, County of San Luis Obispo Parks, Caltrans and the National Parks Service. Outreach includes public workshops, a project web site and social media accounts, as well as a web-based survey to engage stakeholders and the interested public in the identification and refinement of future trail options. Workshops focused on the identification of objectives, issues and concerns, ideas for future trail routing, a review of opportunities and constraints, alternatives analysis and selection and presenting a draft master plan.

The plan will serve as a funding resource and as an implementation guide so that the communities along the river can construct individual segments over time and ensure that these pieces will ultimately be part of a coherent trail system that supports regional economic vitality as both a recreation and transportation enhancement.

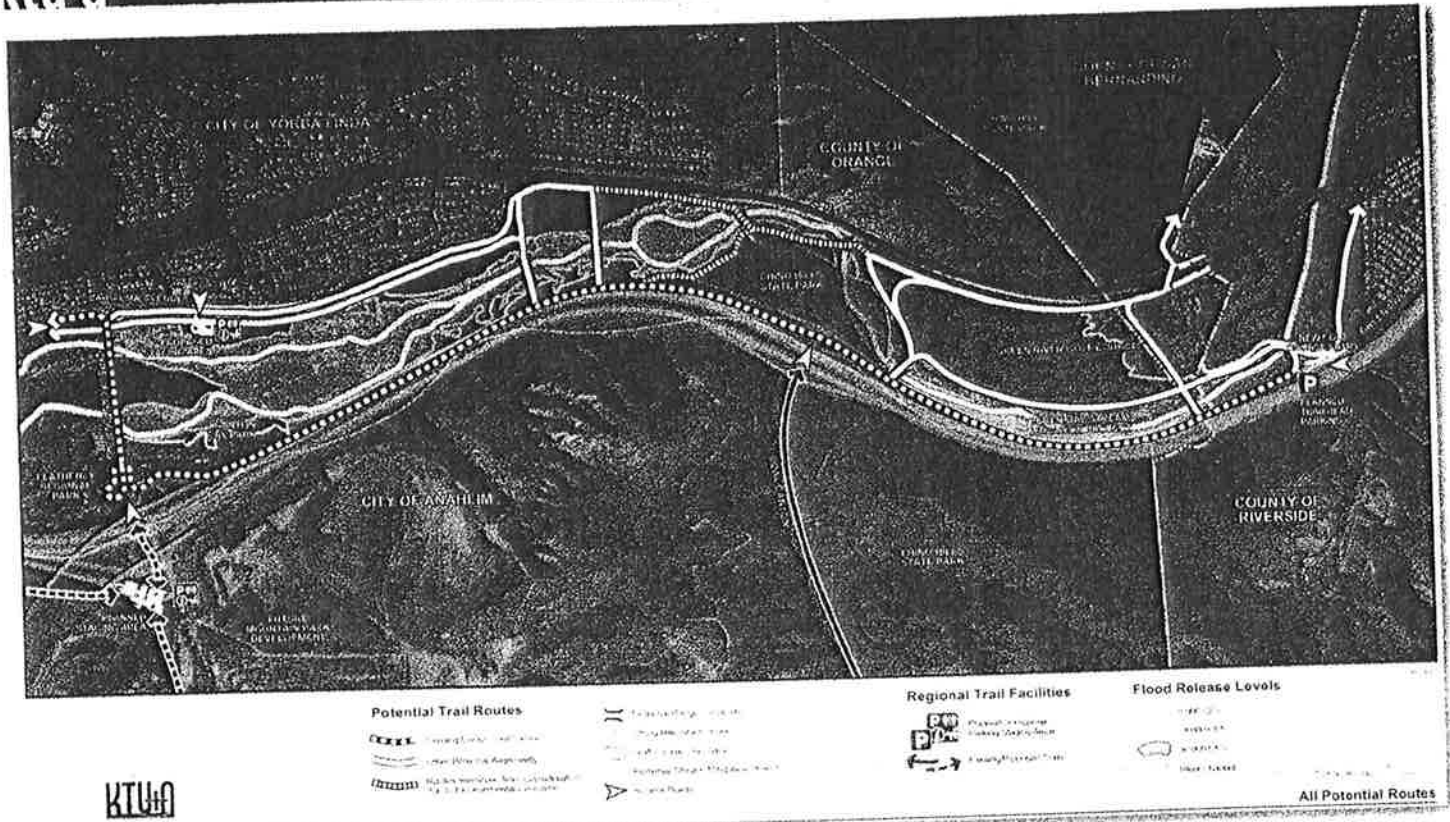

Client

Orange County Public Works
 Jeff Dickman, Regional Recreational Trail Coordinator
 t: 714 647-3937
 e: jeff.dickman@ocpw.ocgov.com

Location

Orange County, CA

Status

Completed 2011
 On schedule and within budget

Services

Trail Planning

KTU+A Key Personnel

John Holloway

Consultants

RBF Consulting (Prime)

The project identified both soft surface trail and paved bikeway alignments for the Santa Ana River Parkway within a two-mile reach of the Santa Ana River corridor in Orange County. These alignments will help complete the parkway/greenway from the Pacific Ocean to the San Bernardino National Forest.

Based on extensive public and agency outreach, preferred trail and bikeway alignments were developed to minimize impacts to the river, river-related habitat, wildlife corridors, flood control and other facilities, and the Green River Golf Course, while maximizing trail user experience.

The study identifies existing and proposed connections to the Santa Ana River Parkway from other trails, bikeways, parks and residential areas within Orange County and the Cities of Yorba Linda and Anaheim, the adjacent Chino Hills State Park, and other county owned open spaces, as well as evaluate potential connecting trail and bikeway alignments proposed by Riverside and San Bernardino Counties and the City of Corona.

The study developed recommendations to improve or expand these connections and identified safety and security issues that may affect the use and enjoyment of the Santa Ana River Parkway, as well as mitigations to eliminate or reduce these constraints.

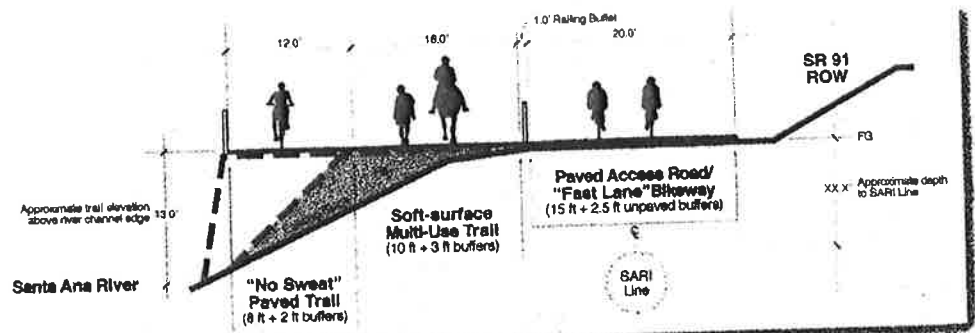

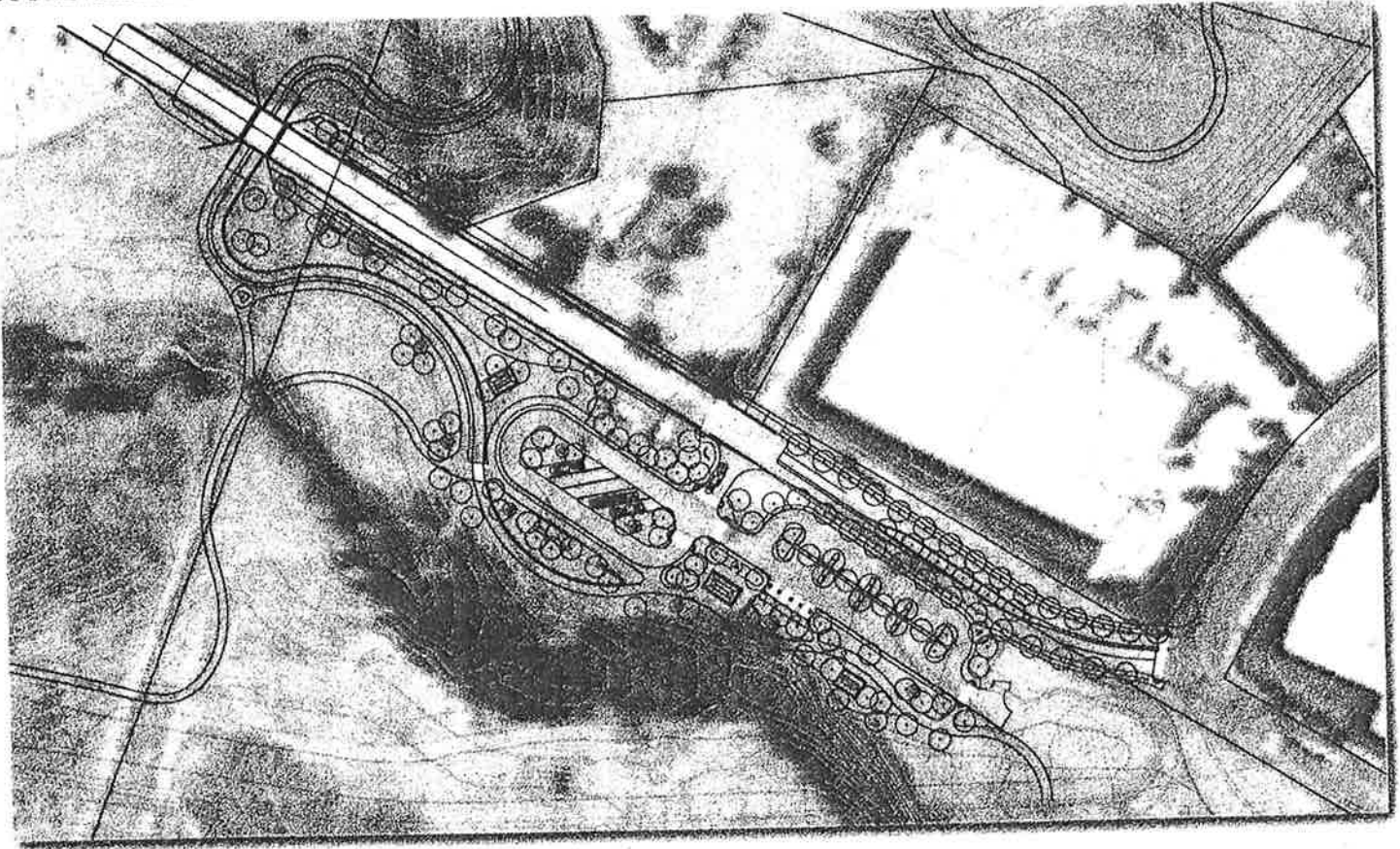

Client

Riverside County Park and Open-Space District (RivCoParks)
 Marc R. Brewer, Senior Park Planner,
 951 955-4316
 e: mbrewer@rivcoparks.org

Location

Riverside County, CA

Status

In progress 2013, 15% complete
 On Schedule

Services

Trail Planning
 Trail Design
 Agency Coordination

KTU+A Key Personnel

John Holloway
 Tim Henderson

Consultants

RBF Consulting (Prime)

This project addresses a seven mile segment of the 75-mile Santa Ana River Trail system that will connect the Pacific Ocean to the San Bernardino National Forest. The project defines both soft surface trail and paved bikeway alignments along the river corridor in Riverside County from the Orange County border through the cities of Corona, Norco and Eastvale. Significant portions of the corridor lie within Army Corps of Engineers and Orange County Water District jurisdiction.

While an earlier concept plan addressed portions of the corridor, significant segments remained undefined, especially on agency properties and areas affected by substantial floodplain and slope constraints. The scope therefore includes trail and amenity design in these areas, as well as associated staging areas, overlooks and neighborhood connections. Once a preferred alignment is agreed upon, construction drawings will be prepared.

Since so much of the corridor lies within agency jurisdiction, outreach and coordination with the Army Corps of Engineers, Orange County Water District, Riverside County and the cities is significant. The preferred trail and bikeway alignment minimizes impacts to the river, river-related habitat, wildlife corridors, flood control and other facilities, as well as to Corps of Engineers and Orange County Water District operations, while maximizing trail user experience.

The study identifies existing and proposed connections to the Santa Ana River Trail from adjoining cities, bikeways, parks and residential areas within Riverside County and the cities, as well as evaluating potential connecting trail and bikeway alignments proposed by Riverside and Orange Counties. The study includes recommendations to improve these connections, as well as mitigations to reduce or eliminate any constraints.

San Dieguito River Park Coast to Crest Trail

ktu+a

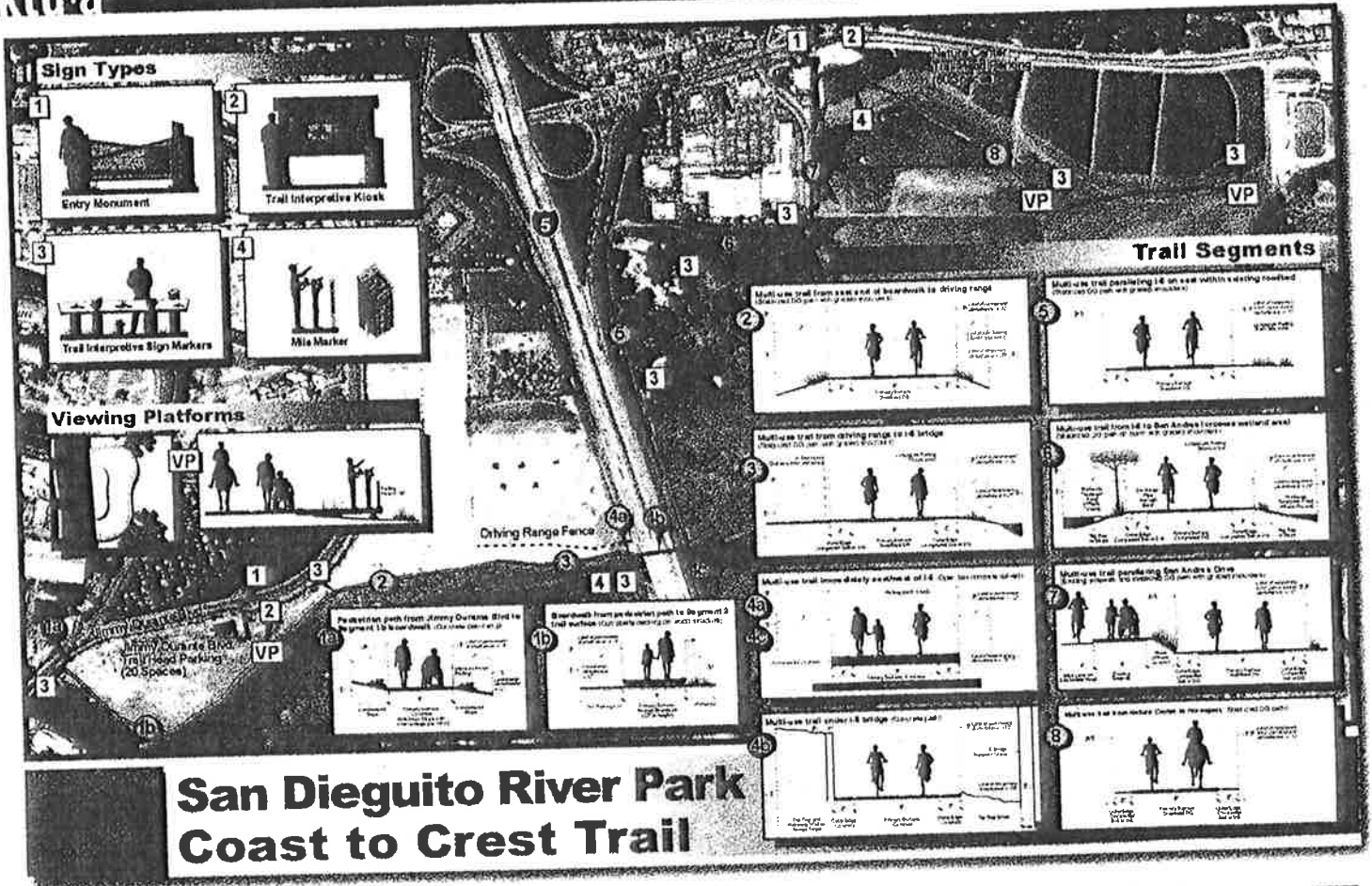

Client

San Dieguito River Park JPA
Susan Carter
t: 858 574-2275
e: susan@sdrp.org

Location

San Diego, CA

Status

Completed 2007
On schedule and within budget

Services

Trail Planning

KTU+A Key Personnel

Mike Singleton
John Holloway
Mark Carpenter

KTU+A worked with the San Dieguito River Open Space Park Joint Powers Authority (JPA) to plan and design the first portions of the Coast to Crest Trail, which will extend from the Pacific Ocean at the mouth of the San Dieguito River in Del Mar to Vulcan Mountain near Julian, approximately 70 miles.

The San Dieguito Lagoon Segment is four-mile trail section parallel to the San Dieguito River. It is being constructed as part of a large wetland restoration project funded by Southern California Edison (SCE) as a condition to operate the San Onofre Nuclear Generating Station (SONGS). The trail traverses various lagoon habitats using new dirt trails, existing dirt roads and an innovative boardwalk design that creates minimal surface impacts and uses recycled decking material. The California Coastal Commission required all aspects of trail design and layout to be carefully evaluated to minimize waterfowl disturbance by maintaining minimum setbacks from open water, and increasing trail user visibility and raptor perching opportunities. To meet FEMA requirements that the trail design not impact the river hydrology, a hinged chainlink fence was constructed between the trail and the existing golf driving range. The fence protects trail users from errant golf balls, while allowing debris to flow through should it accumulate along the fence line.

The trail alignment makes use of overlooks and constructed wetland treatment ponds as educational opportunities with environmental graphics highlighting the significance of Southern California's few remaining wetlands, the impacts they continue to face and the indigenous species that depend on them.

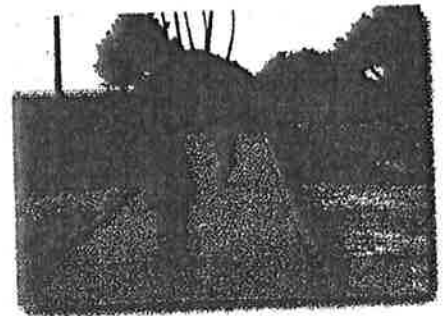

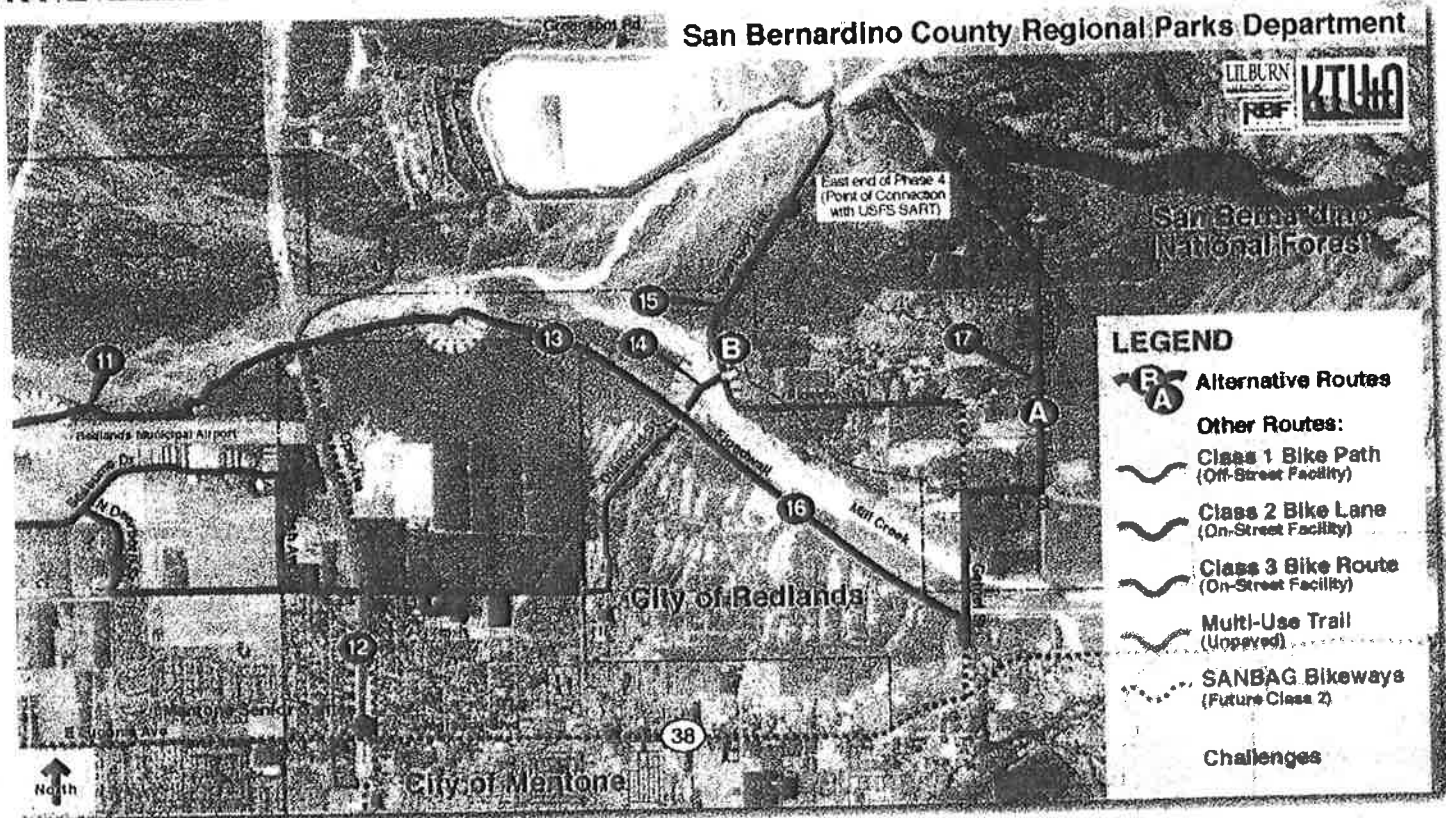

Client

County of San Bernardino
 Jim Canaday
 t: 909 393-3202
 e: jcanaday@parks.sbcounty.gov

Location

San Bernardino, CA

Status

Completed 2013
 Schedule delay due to County
 and US Army Corps of Engineers
 response time

Services

Trail Design

KTU+A Key Personnel

Kurt Carlson
 John Holloway
 Joe Punsalan

Consultants

RBF Consulting
 Geocon

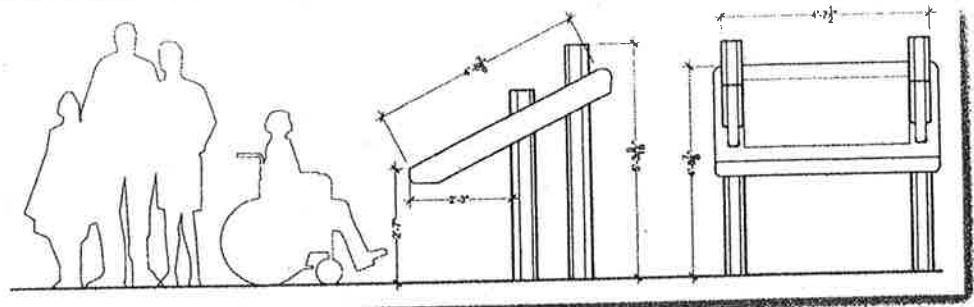

Phase Four of the Santa Ana River Trail (SART) traverses San Bernardino County, primarily along the south levee of the river. This final 11-mile segment is part of a regional trail to link Riverside and Orange Counties and will connect the cities of Redlands, Mentone, Highland and the County of San Bernardino to the existing natural surface trail system in the San Bernardino National Forest. The SART will be constructed primarily upon existing levees and San Bernardino County Flood Control District property. It is designed as a Class 1 multi-use paved trail with a minimum ten foot wide paved surface and a minimum four foot wide non-paved trail. The trail will ramp under Highway 30, Alabama, and Orange Streets.

KTU+A developed trail and recreation plans for Phase 4 from California Street in Redlands to Greenspot Road in Highland where the paved trail will connect to the existing natural surface trail in the San Bernardino National Forest. KTU+A identified passive and active recreation locations, envisioned as a lineal park adjacent to the trail and Santa Ana River. The river corridor provides localized, divergent and often isolated recreational activities ranging from camping, bird watching, hiking, bicycling, and horseback riding to more urban regional park functions.

Services provided included preliminary design, mapping and surveying, right-of-way and utility investigation, environmental studies, preparation of State, Federal and local permit applications, plans, specifications and engineers estimates (PS&E).

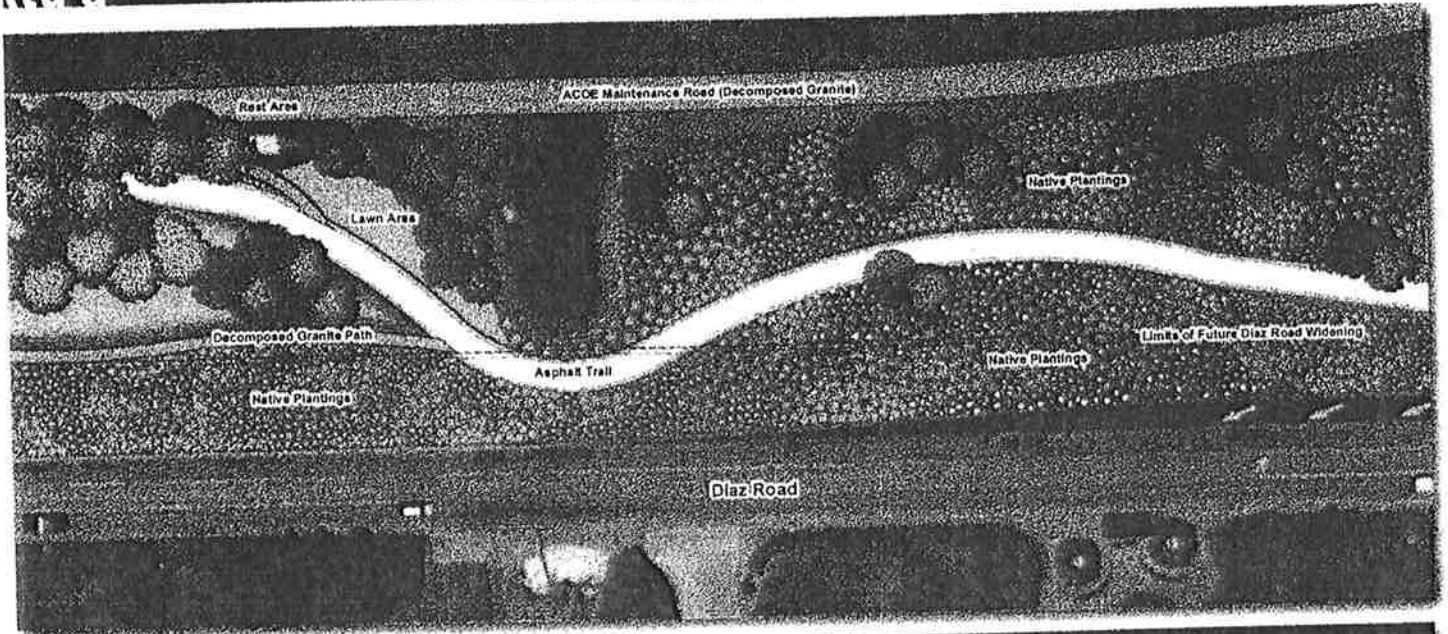

Chaparral Plant Community

Ecology
The Chaparral plant community is a shrubland with a high density of shrubs and small trees. It is typically found in areas with well-drained soils and a Mediterranean climate. The community is characterized by its ability to regenerate after fires.

Flora
The Chaparral plant community is dominated by evergreen shrubs and small trees. Key species include Toyon, Sagebrush, and Red Rock Scrub. The community is highly diverse and supports a wide variety of wildlife.

Murrieta Creek Trail

Client

City of Temecula
Project manager no longer with City of Temecula

Location

Temecula, CA

Status

Completed 2008
On schedule and within budget

Services

Landscape Architecture

KTU+A Key Personnel

Mike Singleton
Dave Leonard

KTU+A provided design services for a new trail along a 1.5-mile section of Murrieta Creek in Temecula. The project included the layout of the trail, as well as planting and non-potable irrigation construction documents. Trail amenities include benches, bike racks, overlooks, signage, drinking fountains and interpretive elements. The trail system includes a pedestrian path, a paved Class 1 multi-use trail for cyclists and equestrians, and an equestrian trail that utilizes the proposed Army Corps of Engineers maintenance road.

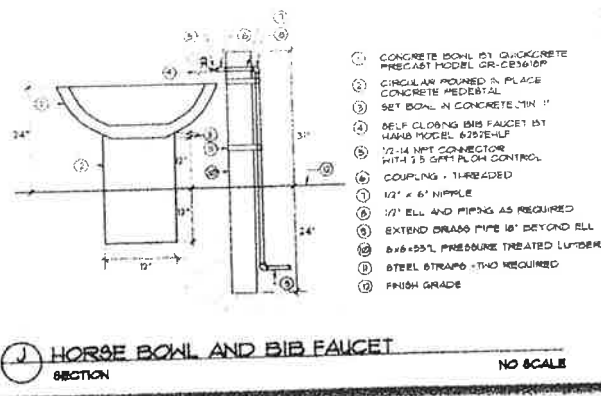

RBF Consulting, a Company of Michael Baker Corporation (RBF) - one of the largest engineering, design and construction management firms in the Nation - has more than 3,200 professionals nationwide with gross engineering revenue of more than \$530 million. The firm's combined resources serve local, national and international markets, with the capability to provide a comprehensive range of services on a national scale for all sizes and categories of projects.

RBF provides planning, design and construction management services for pedestrian, bike, and equestrian trails throughout the western United States.

RBF provides a full range of services including master plans, corridor plans, project design, construction documents and observation, sign plans, plan updates, technical assistance, safety studies, and environmental review and documentation. We offer complete planning, landscape architecture and engineering services.

RBF's planners, engineers, surveyors and landscape architects bring expertise to a project to create appropriate, yet innovative, and environmentally sensitive and highly individualized solutions. RBF has experience working in all sizes of communities, from a few thousand residents to millions, from rural, mountain and desert to suburban and urbanized areas. The firm strives to tailor each project to the community's unique setting, history and culture through active public participation processes.

The RBF Team has extensive expertise in the design and construction of river parkways, Class I Bikeways, riding and hiking trails, and related recreational facilities, including standards and specifications. RBF's planners work on a collaborative basis with in-house engineers and other design professionals to meet the demands of an increasingly complex environment of travel demands, land use patterns, urban form, environmental issues and regulatory agency requirements, with the goal of improving coordination between land use and the supporting transportation system. In addition, background in the development of comprehensive flood control engineering and stormwater management programs is extensive. Objectives focus on the development of functional systems providing necessary flood protection levels while addressing multi-objective issues of stakeholders in the watershed.

BIKE TRAILS / PATHS

- Santa Ana River Channel and Bike Trail Improvements (Orange County, CA)
- Santa Ana River - Phase IV Trail and Recreation Plan (San Bernardino County, CA)
- Salt Creek Bike/Pedestrian Trail (Dana Point, CA)
- Anaheim Wetlands and Bike Trail System (Anaheim, CA)
- Berryessa Creek Trail Reach 3 (Milpitas, CA)
- Bicycle Master Plan (Fullerton, CA)
- Bonita Bike Path (San Diego County, CA)
- Calleguas Creek Channel and Bike Trail System (Ventura, CA)

- City of Long Beach As-Needed Landscape Architecture, includes Bike Trails (Long Beach, CA)
- Culver Drive Realignment and Widening (Irvine, CA)
- Cypress Canyon Bike Trails (Anaheim, CA)
- I-405 / Jeffrey Trail Overcrossing (Irvine, CA)
- Iron Horse Trail Gap Closure (Concord, CA)
- La Quinta Pedestrian and Bicycle Paths Master Plan (La Quinta, CA)
- Los Gatos General Bikeway Plan (Los Gatos, CA)
- Lower Peters Canyon (Irvine, CA)
- Mason Park Bicycle Trail (Irvine, CA)
- Mission Bay South Shores Park (San Diego, CA)
- Norco Bluffs Recreation Study (Norco, CA)
- Ocean Trails Public Amenities and Coastal Access Plan (Rancho Palos Verdes, CA)
- Oceanside Recreational Trails Element (Oceanside, CA)
- Otay Ranch Conceptual Parks and Trails Design (Chula Vista, CA)
- Pacific Electric Bike Trail Connection (Long Beach, CA)
- Peters Canyon Wash Bicycle and Equestrian Trail Feasibility Study (Orange County, CA)
- Portola Parkway Extension (Orange County, CA)
- RiverWay Trails Plan (San Diego, CA)
- San Pasqual Bike Trail Feasibility Study (San Diego, CA)
- Santa Ana River Channel and Bike Trail Improvements (Orange County, CA)
- Street and Flood Control Channel Improvements (Irvine, CA)
- Sweetwater Bike Path (San Diego County, CA)
- Talega Hiking, Bicycle, Equestrian Trails (San Clemente, CA)
- Taylor Yard Multi Use Detention Basin Plan (Los Angeles, CA)
- Trabuco Creek Floodplain Management Program (San Juan Capistrano, CA)
- Yale Avenue Bike Trail (Irvine, CA)

PEDESTRIAN TRAILS

- Aldrich Park Fire Access road and Joint Use Trail at University of California, Irvine (Irvine, CA)
- Berryessa Creek Trail Reach 3 (Milpitas, CA)
- Borrego Canyon Wash Regional Park and Flood Control Improvements (Orange County, CA)
- Cypress Canyon Pedestrian Trails (Anaheim, CA)
- Downtown Vista Redevelopment (Vista Village, Vista, CA)
- Foothill Ranch (Orange County, CA)
- Goodyear Parks, Trails, and Open Spaces Plan (Goodyear, AZ)
- La Quinta Pedestrian and Bicycle Paths Master Plan (La Quinta, CA)
- Mission Bay Redevelopment (San Francisco, CA)
- Mission Bay South Shores Park (San Diego, CA)
- Murdy Ranch Parks and Trails Master Planning (Temecula, CA)
- Norco Bluffs Recreation Study (Norco, CA)
- Ocean Trails Public Amenities and Coastal Access Plan (Rancho Palos Verdes, CA)
- Oceanside Recreational Trails Element (Oceanside, CA)
- Otay Ranch Conceptual Parks / Trails Design (Chula Vista, CA)
- RiverWay Trails Plan, San Diego, CA
- Talega Hiking, Bicycle, Equestrian Trails (San Clemente, CA)

John McCarthy, PE

Registration

Civil Engineer, CA, 47583; NV, 15419; AZ, 51805
 Certified Floodplain Manager, US, 05-01596

Education

B.S., 1989, Civil Engineering, California Polytechnic State University, San Luis Obispo
 Certificate, 1997, Light Construction and Development Management

Mr. McCarthy is experienced in the planning development, final design, and construction of complex public works and private sector projects. Mr. McCarthy's experience is concentrated in the fields of flood control design including the incorporation of multi-use trail systems. He is experienced in the preparation of hydrology studies, floodplain analysis, drainage studies and runoff management plans, detailed hydraulic analyses, and public works improvement plans. He has prepared plans, specifications and estimates (PS&E) for the construction of multi-use trails and flood control facilities for public and private sector clients including: California Department of Transportation, Army Corps of Engineers, Counties of Riverside, Orange, San Bernardino and Ventura.

Santa Ana River Parkway Trail, Corona-Norco-Eastvale Segment (Riverside County, CA)

Ongoing- Project Manager. Responsible for final planning, design, and permitting for approximately 9 miles of this regional trail system in Riverside County. The trail will extend from the outlet channel of the U.S. Army Corps of Engineers Prado Dam facility to City of Eastvale. The trail system includes a soft surface trail for equestrians and hikers, and a paved trail for pedestrians and bicyclists.

Santa Ana River Parkway Trail and Bikeway (Orange County, CA) 2011

Project Manager. This project closes a critical two mile gap in the Santa Ana River (SAR) Bikeway and Trail system, to eventually connect to other planned improvements in Riverside and San Bernardino Counties. The RBF/KTU+A team is working with the County of Orange, the community and stakeholders to prepare alignment concepts, evaluate alignments and impacts to the Santa Ana River hydraulics, and preliminary construction drawings for the recommended alignments. The Santa Ana River Bikeway is a regional Class I (off-road, paved) bikeway; it accommodates pedestrians and non-motorized commuter and recreational bicyclists. The Santa Ana River Trail is a regional riding and hiking trail (unpaved); it accommodates walkers, hikers, runners, joggers, mountain bicyclists, and equestrians.

Peters Canyon Channel Flood Control and Trail Improvements (Orange County, CA)

Project Manager. Responsible for the design and preparation of final plans, specifications, and estimates (PS&E) for approximately 3 miles of regional flood control facilities, bikeways, and

hiking/riding trails along the Peters Canyon and Rattlesnake Canyon Channels. The channel improvements included the construction of new facilities to convey the design 100-year flow rates. The trail improvements were part of the County's regional Peters Canyon Trail system and included paved bikeways and soft-surface riding/hiking trails. Unique features were incorporated into the design of the channels to improve the form and function of the trail system.

Santa Ana River Parkway - Trail and Bikeway (Orange County, CA) 2011
 Project Manager. This project closes a critical two mile gap in the Santa Ana River (SAR) Bikeway and Trail system, to eventually connect to other planned improvements in Riverside and San Bernardino Counties. The RBF/KTU+A team is working with the County of Orange, the community and stakeholders to prepare alignment concepts, evaluate alignments and impacts to the Santa Ana River hydraulics, and preliminary construction drawings for the recommended alignments. The Santa Ana River Bikeway is a regional Class I (off-road, paved) bikeway; it accommodates pedestrians and non-motorized commuter and recreational bicyclists. The Santa Ana River Trail is a regional riding and hiking trail (unpaved); it accommodates walkers, hikers, runners, joggers, mountain bicyclists, and equestrians.

Santa Ana River Reach 9 - Phase 2B - Access Roadway, Bridge and Bike Trail Detour (Riverside and Orange Counties, CA) 2010

Deputy Project Manager. RBF, as part of the Genterra Consultants, Inc. team, was requested to simultaneously complete two fast-track task orders for the U.S. Army Corps of Engineers (Corps) Los Angeles District for the Santa Ana River Reach 9 - Phase 2B project adjacent to and within State Route 91 (SR-91) right-of-way from just east of the Coal Canyon wildlife corridor crossing to just east of the Orange-Riverside County Boundary. Task Order 1 included the design of the new access driveway and bridge for the Green River Golf Club. Task Order 2 included the preparation of final design construction contract plans, and specifications for a bike trail detour and construction staging plan (includes three stages) for the overall project construction.

San Diego Creek Bank Protection and Regional Bike Trail, Planning Area 39 Reach (Irvine, CA)

Drainage Project Manager. RBF prepared the final plans, specifications, and estimates for the design of approximately one mile of bank protection along the San Diego Creek Channel and the installation of the City's master planned bike trail. The trail improvements consisted of the extension of the City's master planned trail from under the I-405 Freeway and the challenging design of a low water crossing of the creek. The final design for the trail low water crossing included a concreted lined bikeway section within the creek floodplain limits with two banks of low flow culverts to address the meandering channel thalweg and riprap slope protection. The improvements were processed through Caltrans to obtain an encroachment permit for construction.

John Tanner, PE

Registration

Registered Civil Engineer, CA, 60132
 Qualified SWPPP Developer/Practitioner, CA, 20476

Education

B.S., 1995, Civil Engineering, San Jose State University

Mr. Tanner is a licensed engineer in the State of California with extensive commercial land development experience. He has served as Project Manager for numerous projects in Riverside and San Diego County. He is experienced in all facets of civil engineering and design. As the Land Development Manager, Mr. Tanner is responsible for the preparation of all improvement plans in the Temecula regional office. He is also responsible for contact negotiations, assigning members to project teams, coordination with government agencies, and project scheduling.

Highway 74 Improvement Plans (Menifee, CA)

Mr. Tanner served as Senior Project Manager for the widening of Highway 74 in Menifee, as required by the SCE Administrative Complex Expansion Project. This project consisted of approximately 3,300 LF of highway widening and utility relocations. This was a Caltrans project.

Jackson Avenue Improvement Plans - CIP 8335 (Murrieta, CA)

Mr. Tanner served as Senior Project Manager for the city of Murrieta Capitol Improvement Project, which connects Ynez Road and the northerly Temecula City Limit Line to Jackson Avenue approximately one mile to the north. Aside from the road and utility relocation designs, the project consists of a six cell arch culvert crossing at Warm Springs Creek and associated environmental clearances and regulatory permits.

Winchester Road (Highway 79) Improvement Plans - (French Valley, CA) - Mr. Tanner served as Senior Project Manager for the widening of Highway 79 in French Valley, as required by the Barratt American Sky View Condominium Project. This project consisted of approximately 3,500 LF of highway widening, storm drain extensions and sewer connection jack and bore permits through Caltrans and Eastern Municipal Water District.

Date Street / Murrieta Hot Springs Alignment Study (Murrieta, CA) - Mr. Tanner served as Project Manager for this alignment study project in the City of Murrieta. This project evaluated a very complicated and highly controversial traffic condition at the Murrieta Hot Springs Road and Winchester Road (Highway 79) intersection. Multiple alignment scenarios were evaluated to introduce the intersection of Murrieta Hot Springs Road and the proposed French Valley Parkway (Date Street). Traffic flow and stacking issues were reviewed along with a mass of existing utilities, which would pose potential conflicts. The preferred alignment alternative was ultimately approved by the Murrieta City Council.

Carlos Ortiz, PE, TE, PTOE - Years of Experience: 24

Registration

Registered Civil Engineer, CA, 57535; Traffic Engineer, CA, 2025
 Civil Engineer, AZ, 34333
 Professional Traffic Operations Engineer, US, 426

Education

B.S., 1989, Civil Engineering, California State Polytechnic University, Pomona

Mr. Ortiz manages the traffic engineering aspects for RBF's transportation projects. Mr. Ortiz's professional experience includes the planning and design of, intelligent transportation systems, traffic signals, traffic signal communication systems (twisted pair, fiber optic, wireless), ramp metering systems, traffic monitoring systems, dynamic message sign systems, roadway and highway lighting, stage construction/traffic handling, and signing and striping. Mr. Ortiz is also experienced in intelligent transportation systems master plans, intersection realignment studies, traffic impact studies, sight distance analysis studies, speed limit studies, left turn storage studies, traffic warrant studies, and stop sign warrant studies for government and private development projects.

Edison Right-of-Way Bike Trail (Anaheim and Stanton, CA)

QA/QC Traffic Engineer for the traffic engineering portion of the Edison Right-of-Way Bike Trail Improvements from Lola Ave to Broadway in the City of Anaheim and Stanton. The project involves the construction of a shared-use Class I bikeway along Southern California Edison (SCE) Right-of-Way designated for the exclusive use of bicycles and pedestrians. The project consist of preparing plans and probable cost estimates for three new mid-block pedestrian/bicycle traffic signals and traffic signing and striping for the bike trail facility and five intersection control locations. The project involves coordination with SCE, the City of Anaheim and Stanton, and Caltrans.

Claremont Boulevard and First Street Traffic Engineering Improvements (Claremont, CA) 2010

Project Manager. The objective of the project is to provide traffic safety and operational benefits to roadway users by adding Class II bicycle lanes and exclusive/two-way left-turn lanes along First Street between Mills Avenue and the existing Class I bike trail system. The project includes the preparation of conceptual plans showing two alternatives and associated preliminary engineer's estimates, and final improvement plans, specifications and estimates (PS&E) for signage, striping and roadway improvements. The restriping improvements will be completed within the existing roadway width through the removal of one through travel lane in each direction. The project goal is to enhance the bikeway systems in the City of Claremont and provide connectivity to the existing Class I bike trail in the City of Montclair. In addition, RBF prepared traffic signal improvement plans for the intersections of Bonita Avenue/Mountain Avenue and Bonita Avenue/Cambridge Avenue.

With more than 30 years of experience, FirstCarbon Solutions | Michael Brandman Associates (FCS), a leading provider of sustainability, environmental and compliance solutions, delivers fully-integrated consulting, software, and data management services. Known for being highly responsive to client needs, FCS helps both private companies and government institutions improve sustainability and navigate environmental and regulatory processes.

With a full complement of environmental and sustainability services, FCS works with you to:

- Identify potential environmental challenges
- Develop cost-effective sustainability and mitigation solutions
- Streamline the environmental review process
- Reduce costs and improve your overall operational efficiency

FCS provides practical and proven solutions to your specific environmental challenges including industry-leading planning services and legally defensible environmental documentation covering CEQA and NEPA analysis, biological and cultural resource assessments, regulatory permitting, restoration planning and monitoring, water resource management, and air quality and noise studies.

In addition, FCS is a recognized leader in sustainability, energy and carbon management solutions, supply chain and life cycle assessments, and software and data processing services. Whether you are looking to streamline the environmental review process or improve your sustainability practices, we work with you to improve your performance organization-wide. FCS is a member of ADEC Group, a privately held business with over 5,000 employees, and operations in North America, Europe, Asia and Australia.

Trusted since its inception in 1998, ADEC Group has worked with both public and private sector clients to reduce costs, optimize resource use, and improve operational efficiencies. As part of ADEC Group, FCS has the proven capabilities, experience and resources to create and deliver value-added environmental, sustainability and compliance solutions to help you realize cost savings and optimize performance.

Environmental Assessment for the Santa Ana River Trail, City of Corona/Dangermond Group (FCS|MBA).

FCS|MBA is working with the Dangermond Group on a biological assessment of various routes associated with a hiking, bike, and equestrian trail project located along the Santa Ana River in Riverside County. This portion of the trail will extend from Hidden Valley County Park (east of the I-15 river crossing) through the Prado Basin and extending to the Orange County line. Preliminary field surveys were conducted in the summer of 2008 and more intensive surveys are on-going to determine the presence of sensitive species such as least Bell's vireo, southwestern willow flycatcher, burrowing owl, and sensitive plants. In addition to completing the biological surveys, the

MBA team conducted cultural resources records searches and prepared the California Environmental Quality Act (CEQA) and the National Environmental Policy Act (NEPA) documents for the project.

Chino Hills Open Space Management Plan for RRM Design Group (FCS|MBA)

FCS|MBA is completing biological, restoration and air quality studies for the Chino Hills Open Space Management Plan. The City of Chino Hills currently has over 3,000 acres of open space within the existing city limits. RRM Design Group is preparing a Management Plan for the City of Chino Hills. FCS|MBA provided biological support with an emphasis on natural resources studies and approaches for maintenance and restoration of the mostly non-native grasslands within the open space. The recommendations included intensive grazing by sheep and goats at specific seasons of the year in areas abutting more native vegetation. The goal was to keep vegetation under control for fuel management and increasing the potential for native species to return to portions of the existing open space. A greenhouse gas analysis was completed to assist the City in meeting AB 32 requirements by preparing an assessment of existing carbon emissions and approaches to reduce carbon emissions associated with the open space.

Initial Study/Mitigated Negative Impact (IS/MND) Report for the Indio Sports Park/Public Safety Complex for the City of Indio CA (FCS|MBA).

Michael Brandman Associates prepared an Environmental Assessment (EA) in accordance with the California Environmental Quality Act (CEQA) and the State Guidelines for Implementation of CEQA. CEQA refers to this document as an Initial Study, while the City of Indio, as dictated by the County of Riverside, refers to an IS/MND as an EA. The EA evaluated the potential environmental impacts associated with construction and the associated improvements for a new public facility at the southeast corner of Avenue 44 and Jackson Street in Indio. The EA determined that with the recommended mitigation measures, the project will not have a significant impact on the environment.

Environmental Impact Report for MacArthur Park Improvement Project for City of Los Angeles Park and Recreation (FCS|MBA).

FCS|MBA was retained to prepare an EIR for the MacArthur Park Improvement Plan Project. Environmental documentation was prepared for all potentially significant impacts and issues including cultural and historic analysis, traffic and parking, and hydrology and water quality. The City proposes upgrading existing park facilities and providing new and expanded recreational opportunities for the citizens of and visitors to the City.

Kenneth J. Lord, Ph.D., RPA

Director, Natural/Cultural Resources

Associations and Certifications

- Association of Environmental Professionals
- Riverside County Certified Archaeologist #100
- Registered Professional Archaeologist #11821

Education

- Doctorate degree, Archaeology – University of Texas, Austin
- Bachelor's degree, Anthropology – University of Pittsburgh

Kenneth Lord has managed multi-disciplinary teams preparing Environmental Impact Studies (EISs) and Environmental Impact Reports (EIRs) that have been used by the Federal Energy Regulatory Commission, US Army Corps of Engineers, and State of California agencies in licensing pipeline projects in California and the western United States. Ken has been involved in management of the construction/ environmental compliance monitoring associated with a variety of development projects. Ken's experience encompasses the reconnaissance, feasibility, and environmental impact aspects of a variety of project types. He is knowledgeable about California's county environmental documentation procedures and regulations, as well as other federal and state environmental laws, regulations, and guidelines. Ken prepared and supervised the preparation of EIRs, EISs, and Biological Assessments in accordance with NEPA and CEQA rules and regulations.

Experience and Client Summary

- Environmental Assessment for the Santa Ana River Trail, City of Corona/Dangermond Group
- Kona Road III Project Cultural Resources Survey, French Valley Area, County of Riverside
- Newport Road Project Cultural Resources Assessment, Menifee Area, County of Riverside
- Taylor-Woodrow Ivy House Project Cultural Resources Assessment, Murrieta, County of Riverside
- Lake Elsinore Property Cultural Resources Report, City of Lake Elsinore
- Cultural Resources Survey Report, Phase I for tentative tract 33862, San Jacinto
- Pigeon Pass Property Cultural Resources Assessment, Moreno Valley
- Cultural Resources Assessment, Phase I of Tract 34150 French Valley, County of Riverside
- Cultural Resources Survey, Phase I, Corona
- Menifee Farms Project Cultural Resources Assessment, Menifee Valley, County of Riverside
- Temecula Lane 2 Property Cultural Resources Assessment, City of Temecula
- Ramona Expressway and Alessandro Avenue Project Cultural Resources Assessment, San Jacinto
- Reese-Chambers Systems Consultants, Inc./Cabazon Indian Tribe, Master Planned Development EA, County of Riverside

Scott Crawford, MA

Biologist

Associations and Certifications

- FEDERAL PERMIT # TE019947-4 California gnatcatcher, Quino Checkerspot Butterfly, Listed Fairy Shrimp
- FEDERAL PERMIT # TE019947-2 Previously included El Segundo Blue Butterfly
- Collection Permit: 801087-04 Exp. 1/19/2014
- Flat-Tailed Horned Lizard 6/2001
- Wetland Training Institute 12/1998
- Desert Tortoise Council Workshop 10/1999
- Desert Tortoise Egg Handling/Artificial Burrow construction 10/1999
- Project Management Boot Camp 1 – PSMJ Resources, Inc. 3/2004
- Managing Multiple Project Objectives and Deadlines, Skill Path 1/2006
- Registered Wildlife Biologist – San Diego, Los Angeles, Riverside, San Bernardino, and Orange County
- Fairy Shrimp Identification Class:
- Denton Belk: November 1999
- The Wildlife Society

Education

- Master's degree, Biological Science – California State University, Fullerton
- Bachelor's degree, Environmental Biology – California State University, Northridge

Scott Crawford is currently the Section Manager of Biological Resources and assists in the management of the natural resource team at MBA. He extensive experience in project related consultations with regulatory agencies including California Department of Fish and Wildlife (DFW), US Fish and Wildlife Service (USFWS), US Army Corps of Engineers (USACE), California Coastal Commission (CCC), and State Water Resources Control Board (SWRCB), California Energy Commission (CEC), Federal Energy Regulatory Commission (FERC), Department of Gas and Geothermal Regulations (DOGGR), Bureau of Land Management (BLM), and US Forest Service (USFS).

- Environmental Assessment for the Santa Ana River Trail, City of Corona/Dangermond Group
- Riverside Fairy Shrimp Protocol Survey, Oliver Cagle, Riverside County
- Riverside Fairy Shrimp Protocol Survey, Courdures LLC, City of Perris
- Riverside Fairy Shrimp Protocol Survey, Classic Pacific, City of Beaumont
- Pacific Pocket Mouse Focused Surveys, Transportation Corridor Authority
- Winokur Residential Property Biological Resources Assessment/ESHA Assessment, City of Malibu
- Central Capital Corporation Biological Resources Assessment, City of La Habra

Collin Ramsey

Environmental Analyst

Overview

Collin has gained valuable professional and academic insight into environmental planning and policy issues through six years of practical and educational experience. As an Assistant Project Manager at FCS-MBA, he regularly participates in the CEQA and NEPA environmental documentation process, including the preparation of Categorical Exemptions, Categorical Exclusions, Initial Studies, Environmental Assessments, Mitigated Negative Declarations, and Environmental Impact Reports.

Associations and Certifications

- USGBC LEED Green Associate #10647492

Education

- Master's degree, Environmental Studies – University of California, Fullerton
- Bachelor's degree, Film Studies – University of California, Santa Barbara

Collin Ramsey has also contributed on several mixed-use projects with sustainable design, construct, and operation elements. In 2011, he received his LEED Green Associate certification from the U.S. Green Building Council, the authority in green building design. Collin has a Bachelor's degree in Film Studies from the University of California, Santa Barbara, and a Master's degree in Environmental Studies from California State University, Fullerton. He is an active member of the Association of Environmental Professionals, American Planning Association, and the U.S. Green Building Council.

Experience and Client Summary

- Environmental Assessment for the Santa Ana River Trail, City of Corona/Dangermond Group
- Anaheim Uptown Village Mixed-Use Development, IS/MND, Anaheim, CA
- Metropolis Mid-Rise Residential Development, Focused Addendum EIR, Irvine, CA
- Santa Ana River Trail, IS/MND and EA, County of Riverside, CA
- Stanton Central Park, IS/MND, Stanton, CA
- Mira Loma Recharge Basin, IS and EIR, Anaheim, CA
- Linda Vista Reservoir, MND, Anaheim, CA
- Walmart EIR, City of Wasco, CA
- Chino South Industrial EIR, City of Chino, CA
- National Orange Show Industrial EIR, City of San Bernardino, CA

Dale Hameister

Biologist

Overview

14 years experience as an Biologist specializing in biological resource technical reports. His extensive knowledge of California's flora and fauna combines with experience in biological assessments, wetland assessments, and regulatory compliance to facilitate public agency projects involving multiple government agencies: California Department of Fish and Game, United States Fish & Wildlife Service, Army Corp of Engineers, California State Parks, and numerous counties and local agencies.

Permits and Certifications

- ISA Certified Arborist

Education

- Bachelor's degree, Earth System Science and Policy, 1998 – California State University, Monterey Bay

Dale Hameister's scope of work includes preparing biological assessment reports, jurisdictional delineations, native landscape plans, erosion control plans, mitigation and restoration plans, rare species recover plans, and performing fieldwork that involves protocol surveys and construction site monitoring. Dale is thoroughly familiar with GIS, GPS, and aerial photography for use in habitat classification, impact analysis, and natural resource planning.

Experience and Client Summary

- Rancho Vista Village, Habitat Assessment and MSHCP Consistency Analysis, City of Temecula, CA
- Guava Street Improvement Project, Biological Surveys and CRAM evaluations, Murrieta, CA
- Redlands Crossing EIR, Biological Surveys and small mammal trapping, City of Redlands, CA
- FST Sand and Gravel, Biological Surveys, Habitat Assessments and MSHCP Consistency Analysis, Corona, CA
- Plunge and Elder Creeks, San Bernardino Flood Control District, Detailed Surveys and mapping, Highland, CA
- Cable Creek Bottom Control Maintenance Project, Maintenance permitting, San Bernardino, CA
- Focused Sensitive Plant Surveys, Public Safety Enterprise Communication Project, Riverside and San Diego Counties, CA
- Coachella Valley MSHCP Consistency Analysis, Palm Springs Unified School District Cabot Yerxa Elementary School, City of Desert Hot Springs, Riverside County, CA
- Rock Honda Burrowing Owl Focused Survey Report, City of Fontana, San Bernardino County, CA
- Mount Olympus Preserve, Biological Inventory, San Diego County, CA
- Wilderness Gardens Preserve, Biological Inventory, San Diego County, CA

Firm Profile

Geocon West, Inc. (Geocon) is an employee-owned California corporation established in 1971. We offer a full range of geotechnical engineering, construction observation, special inspection, materials testing, and laboratory testing services for projects throughout the United States. We employ approximately 200 full-time personnel at 10 offices throughout California.

Geocon has serviced the County of Riverside for over 33 years, with our first project commencing in 1980. We have maintained a permanent place of business in Riverside County for the past 22 years, opened our second Riverside County office in Palm Desert in 2010, and have experience providing geotechnical and materials testing services for trail projects throughout the state. Services performed for this contract will be provided by our Murrieta office and personnel. Our project contact information is:

Contact Information

Firm Name: Geocon West, Inc.

Murrieta Address: 41571 Corning Place, Suite 101, Murrieta, CA 92562

Contact: Lisa Battiato, CEG- Project Manager

Phone: 951.304.2300

Email: battiato@geoconinc.com

We have provided a wide range of consulting services for trail projects throughout California. Some of our project experience is summarized below:

- Santa Gertrudis Creek Bike Trail, Temecula
- Class I Bike Path Improvements, El Dorado County
- Bob Jones Bike Trail & Pedestrian Bridge, San Luis Obispo
- Greenway Trail Project, Whittier
- Sunset Cliffs Bridge Bike Lane/Trail, San Diego
- Rancho Santa Fe Polo Exercise Trail, San Diego
- Willow Creek Gap Closure Trail – Bicycle/Pedestrian Bridge, Folsom
- Folsom Parkway Trail Phase II, Folsom
- Garrapata State Park Beach Access Trail, Monterey County
- Guadalupe River Trail, San Jose
- H Street Bike Trail, Sacramento
- Kikkoman Bike Trail, Folsom
- Oak and Waterfront Bike Trail, Oakland

Lisa A. Battiato, CEG, LEED® AP
Senior Geologist

EDUCATION

- University of California, Riverside, B.S. Geology – 1996
- ASFE Fundamentals of Professional Practice, 2007

PROFESSIONAL REGISTRATIONS

- Engineering Geologist, CA 2316
- Professional Geologist, CA 7512

PROFESSIONAL CERTIFICATIONS

- OSHA 40-Hour Hazwoper
- LEED Accredited Professional
- Geothermal Professional
- Pavement Management Professional (in progress)
- ACI Level 1 Technician

Ms. Battiato has over 16 years of experience providing geologic consulting services throughout California. Her experience encompasses a wide range of projects including: transportation and water infrastructure; educational, medical, commercial and industrial facilities; mixed-use and multi-family residential developments; and other large-scale land developments. Her technical expertise includes: seismic hazard analyses; subsurface fault, landslide, liquefaction, geotechnical investigations and assessment; geologic mapping; pavement distress mitigation; geotechnical services during utility installation and roadway construction; geologic evaluation of levee stability; project management services for large, hillside grading projects; and supervision of materials testing services during construction. Ms. Battiato has been actively involved in determining methods and design necessary for slope stabilization, seepage, mitigation of collapsible soils, induced soil settlement, expansive soils, subsurface dewatering and drainage.

Santa Ana River Trail, Highland, California

Performed the geotechnical exploration work along the Santa Ana River within the City of Highland for the Santa Ana River Trail design.

UPRR Overpass, Indian Canyon Drive, Palm Springs, California

Provided project management and coordination for the geotechnical investigation and foundation reports. State Route 62 Realignment and Widening, Yucca Valley, California. Ms. Battiato performed a geologic hazard review and a geotechnical summary of the widening and realignment of State Route 62 through Yucca Valley, California

East Palm Canyon Bridge Widening, Cathedral City, California

Provided geotechnical and materials inspection project management throughout construction of the bridge widening, infrastructure improvements and slope grading. She provided geologic mapping and slope stability recommendations for the rock cut slope excavated to facilitate roadway widening.

EXHIBIT D

Period of Performance

The District's approximate time schedule for completion of each portion of these projects is as follows:

Survey Work and Calculations:	September 25, 2013 – October 9, 2013
Design:	October 10, 2013 – November 7, 2013
Construction Documents:	November 8, 2013 – February 22, 2014

CAVIGNAC ASSOCIATES

INSURANCE BROKERS
License No. 0A99520

450 B Street, Suite 1800 San Diego, CA 92101-8005
Tel. 619.234.6848 • Fax 619.234.1239 • Web www.cavignac.com

Riverside County Regional Park and Open-Space District
ATTN: Julie Smith-Campbell
4600 Crestmore Rd
Jurupa Valley, CA, 92509

Aug 29, 2013

Re: KTU & A

To Whom It May Concern:

Enclosed is a certificate of insurance, as requested. If you have questions or require changes, please contact our office via email (certificates@cavignac.com) or fax (619-234-1239). Please include a copy of the certificate with your request or reference ID number 236219.

Sincerely,

Cavignac & Associates Certificate Department
certificates@cavignac.com
619-234-1239 (fax)

cc: Susan Cailing (susan@ktua.com)

KTU & A - Certificate of Insurance



CERTIFICATE OF LIABILITY INSURANCE

DATE (MM/DD/YYYY)
8/29/2013

THIS CERTIFICATE IS ISSUED AS A MATTER OF INFORMATION ONLY AND CONFERS NO RIGHTS UPON THE CERTIFICATE HOLDER. THIS CERTIFICATE DOES NOT AFFIRMATIVELY OR NEGATIVELY AMEND, EXTEND OR ALTER THE COVERAGE AFFORDED BY THE POLICIES BELOW. THIS CERTIFICATE OF INSURANCE DOES NOT CONSTITUTE A CONTRACT BETWEEN THE ISSUING INSURER(S), AUTHORIZED REPRESENTATIVE OR PRODUCER, AND THE CERTIFICATE HOLDER.

IMPORTANT: If the certificate holder is an ADDITIONAL INSURED, the policy(ies) must be endorsed. If SUBROGATION IS WAIVED, subject to the terms and conditions of the policy, certain policies may require an endorsement. A statement on this certificate does not confer rights to the certificate holder in lieu of such endorsement(s).

PRODUCER Cavignac & Associates 450 B Street, Suite 1800 San Diego, CA 92101-8005 License No. OA99520	CONTACT NAME: Certificate Department PHONE (A/C No. Ext): 619-234-6848 E-MAIL ADDRESS: certificates@cavignac.com	FAX (A/C No.): 619-234-8601
	INSURER(S) AFFORDING COVERAGE	
INSURED KTU & A 3916 Normal Street San Diego, CA 92103 United States	INSURER A: TRAVELERS PROP CAS CO OF AMER 25674	
	INSURER B: HARTFORD ACCIDENT & IND CO 22357	
	INSURER C: XL SPECIALTY INS CO 37885	
	INSURER D:	
	INSURER E:	
	INSURER F:	

COVERAGES **CERTIFICATE NUMBER:** 235192 **REVISION NUMBER:** 236219

THIS IS TO CERTIFY THAT THE POLICIES OF INSURANCE LISTED BELOW HAVE BEEN ISSUED TO THE INSURED NAMED ABOVE FOR THE POLICY PERIOD INDICATED. NOTWITHSTANDING ANY REQUIREMENT, TERM OR CONDITION OF ANY CONTRACT OR OTHER DOCUMENT WITH RESPECT TO WHICH THIS CERTIFICATE MAY BE ISSUED OR MAY PERTAIN, THE INSURANCE AFFORDED BY THE POLICIES DESCRIBED HEREIN IS SUBJECT TO ALL THE TERMS, EXCLUSIONS AND CONDITIONS OF SUCH POLICIES. LIMITS SHOWN MAY HAVE BEEN REDUCED BY PAID CLAIMS.

INSR LTR	TYPE OF INSURANCE	ADDL INSR	SUBR WVD	POLICY NUMBER	POLICY EFF (MM/DD/YYYY)	POLICY EXP (MM/DD/YYYY)	LIMITS
A	GENERAL LIABILITY <input checked="" type="checkbox"/> COMMERCIAL GENERAL LIABILITY <input type="checkbox"/> CLAIMS-MADE <input checked="" type="checkbox"/> OCCUR <input checked="" type="checkbox"/> Contractual Liability <input checked="" type="checkbox"/> Separation of Insureds GEN'L AGGREGATE LIMIT APPLIES PER: <input type="checkbox"/> POLICY <input checked="" type="checkbox"/> PROJECT <input type="checkbox"/> LOC		X	6801C93201A	9/1/2013	9/1/2014	EACH OCCURRENCE \$ 1,000,000 DAMAGE TO RENTED PREMISES (Ea occurrence) \$ 300,000 MED EXP (Any one person) \$ 10,000 PERSONAL & ADV INJURY \$ 1,000,000 GENERAL AGGREGATE \$ 2,000,000 PRODUCTS - COMPOP AGG \$ 2,000,000 Deductible \$ 0
A	AUTOMOBILE LIABILITY <input type="checkbox"/> ANY AUTO <input type="checkbox"/> ALL OWNED AUTOS <input type="checkbox"/> SCHEDULED AUTOS <input checked="" type="checkbox"/> HIRED AUTOS <input checked="" type="checkbox"/> NON-OWNED AUTOS <input checked="" type="checkbox"/> No Company Owned Autos		X	BA1C934192	9/1/2013	9/1/2014	COMBINED SINGLE LIMIT (Ea accident) \$ 1,000,000 BODILY INJURY (Per person) \$ BODILY INJURY (Per accident) \$ PROPERTY DAMAGE (Per accident) \$ \$
	UMBRELLA LIAB <input type="checkbox"/> OCCUR EXCESS LIAB <input type="checkbox"/> CLAIMS-MADE DED <input type="checkbox"/> RETENTIONS \$						EACH OCCURRENCE \$ AGGREGATE \$ \$
B	WORKERS COMPENSATION AND EMPLOYERS' LIABILITY ANY PROPRIETOR/PARTNER/EXECUTIVE OFFICER/MEMBER EXCLUDED? (Mandatory in NH) If yes, describe under DESCRIPTION OF OPERATIONS below		Y/N	72WECGA4159	9/1/2013	9/1/2014	<input checked="" type="checkbox"/> WC STATUTORY LIMITS <input type="checkbox"/> OTHER E.L. EACH ACCIDENT \$ 1,000,000 E.L. DISEASE - EA EMPLOYEE \$ 1,000,000 E.L. DISEASE - POLICY LIMIT \$ 1,000,000
C	Professional Liability			DPR9709701	9/1/2013	9/1/2014	Ea Claim & Aggreg \$2,000,000

DESCRIPTION OF OPERATIONS / LOCATIONS / VEHICLES (Attach ACORD 101, Additional Remarks Schedule, if more space is required)
 Re: PKARC - 140 Salt Creek Trails Project. Additional Insured coverage applies to General and Automobile Liability for Riverside County Regional Park and Open-Space District, the County of Riverside, its Agencies, Districts, Special Districts, and Departments, their respective directors, officers, Board of Supervisors, employees, elected or appointed officials, agents, or representatives per policy form. Prof. Liab. - Claims made, defense costs included within limit.

CERTIFICATE HOLDER Riverside County Regional Park and Open-Space District 4600 Crestmore Rd Jurupa Valley, CA 92509 United States	CANCELLATION SHOULD ANY OF THE ABOVE DESCRIBED POLICIES BE CANCELLED BEFORE THE EXPIRATION DATE THEREOF, NOTICE WILL BE DELIVERED IN ACCORDANCE WITH THE POLICY PROVISIONS. AUTHORIZED REPRESENTATIVE Dorothy Amundson
--	--

© 1988-2010 ACORD CORPORATION. All rights reserved.

THIS ENDORSEMENT CHANGES THE POLICY. PLEASE READ IT CAREFULLY.

BLANKET ADDITIONAL INSURED (ARCHITECTS, ENGINEERS AND SURVEYORS)

This endorsement modifies insurance provided under the following:

COMMERCIAL GENERAL LIABILITY COVERAGE PART

A. The following is added to WHO IS AN INSURED (Section II):

Any person or organization that you agree in a "contract or agreement requiring insurance" to include as an additional insured on this Coverage Part, but only with respect to liability for "bodily injury", "property damage" or "personal injury" caused, in whole or in part, by your acts or omissions or the acts or omissions of those acting on your behalf.

- a. In the performance of your ongoing operations;
- b. In connection with premises owned by or rented to you; or
- c. In connection with "your work" and included within the "products-completed operations hazard".

Such person or organization does not qualify as an additional insured for "bodily injury", "property damage" or "personal injury" for which that person or organization has assumed liability in a contract or agreement.

The insurance provided to the additional insured is limited as follows:

- d. This insurance does not apply on any basis to any person or organization for which coverage as an additional insured specifically is added by another endorsement to this Coverage Part.
- e. This insurance does not apply to the rendering of or failure to render any "professional services".
- f. The limits of insurance afforded to the additional insured shall be the limits which you agreed in that "contract or agreement requiring insurance" to provide for that additional insured, or the limits shown in the Declarations for this Coverage Part, whichever are less. This endorsement does not increase the limits of insurance stated in the **LIMITS OF INSURANCE (Section III)** for this Coverage Part.

B. The following is added to Paragraph a. of 4. Other Insurance in COMMERCIAL GENERAL LIABILITY CONDITIONS (Section IV):

However, if you specifically agree in a "contract or agreement requiring insurance" that the insurance provided to an additional insured under this Coverage Part must apply on a primary basis, or a primary and non-contributory basis, this insurance is primary to other insurance that is

available to such additional insured which covers such additional insured as a named insured, and we will not share with the other insurance, provided that:

- (1) The "bodily injury" or "property damage" for which coverage is sought occurs; and
- (2) The "personal injury" for which coverage is sought arises out of an offense committed;

after you have entered into that "contract or agreement requiring insurance". But this insurance still is excess over valid and collectible other insurance, whether primary, excess, contingent or on any other basis, that is available to the insured when the insured is an additional insured under any other insurance.

C. The following is added to Paragraph 8. Transfer Of Rights Of Recovery Against Others To Us in COMMERCIAL GENERAL LIABILITY CONDITIONS (Section IV):

We waive any rights of recovery we may have against any person or organization because of payments we make for "bodily injury", "property damage" or "personal injury" arising out of "your work" performed by you, or on your behalf, under a "contract or agreement requiring insurance" with that person or organization. We waive these rights only where you have agreed to do so as part of the "contract or agreement requiring insurance" with such person or organization entered into by you before, and in effect when, the "bodily injury" or "property damage" occurs, or the "personal injury" offense is committed.

D. The following definition is added to DEFINITIONS (Section V):

"Contract or agreement requiring insurance" means that part of any contract or agreement under which you are required to include a person or organization as an additional insured on this Coverage Part, provided that the "bodily injury" and "property damage" occurs, and the "personal injury" is caused by an offense committed:

- a. After you have entered into that contract or agreement;
- b. While that part of the contract or agreement is in effect; and
- c. Before the end of the policy period.