

to County or Contractor associated with interruption of a utility service as a result of Contractor's breach of, or failure to fully comply with, its obligations under this Paragraph shall be paid for by Contractor at Contractor's Own Expense.

3.14.4 **Sanitary Facilities.** Contractor shall provide sanitary temporary toilet facilities, for the use of all the workers, in no fewer numbers than required by Applicable Laws, plus such additional facilities as may be directed by County. Such facilities shall be maintained in a sanitary condition at all times. Use of existing or permanent toilet facilities shall not be permitted except by written consent of County.

### 3.15 **CLEANING UP**

3.15.1 **Contractor Responsibility.** Contractor at all times shall keep the Site free from debris such as waste, rubbish and excess materials and equipment caused by the performance of the Work. At the end of each Day that Work is performed, Contractor shall not leave debris under, in or about the Site but shall promptly dispose of or remove same from the Site. Without limitation to the other clean up requirements of the Contract Documents, upon Final Completion, Contractor shall: (1) clean the interior and exterior of the buildings, including fixtures, equipment, walls, floors, ceilings, roofs, window sills and ledges, horizontal projections and any areas where debris has collected so surfaces are free from foreign material or discoloration; (2) clean and polish all glass, plumbing fixtures, finish hardware and similar finish surfaces and equipment; and (3) remove temporary fencing, barricades, planking, sanitary facilities and similar temporary facilities from the Site.

3.15.2 **Cleanup by County.** If Contractor fails upon 24 hours' notice by County to perform its obligation to clean up, County may arrange to do so, and the cost thereof shall be borne by Contractor at Contractor's Own Expense.

### 3.16 **ACCESS TO THE WORK**

3.16.1 **County.** County, Inspectors of Record, Architect and County Consultants, and their representatives, and such other persons as authorized by County, shall at all times have access to the Work, either in preparation or in progress. Contractor shall provide safe and proper facilities for such access so that they and their representatives may perform their functions safely.

3.16.2 **Separate Contractors.** County, using its own forces or those of Separate Contractors, may, at any time during the performance of the Work, enter the Site for the purpose of performing construction or for any other purpose. Contractor shall cooperate with County, County's own forces and Separate Contractors and not interfere with other work being done by them or on their behalf.

3.16.3 **Delivery Routes.** Contractor shall arrange for delivery of material over routes designated by County.

### 3.17 **INTELLECTUAL PROPERTY RIGHTS**

Contractor shall pay all royalties and license fees relating to use of Intellectual Property Rights pertaining to Work performed. Contractor shall defend suits or claims for infringement of Intellectual Property Rights and shall defend, indemnify and hold harmless the Indemnitees from Loss on account thereof in accordance with the terms of Section 3.18, below, unless the infringement is due to a particular design, process, product or product of a particular manufacturer that is required by the Contract Documents; provided, however, that if Contractor has information leading it to believe that the use of a particular design, process or product required by the Contract Documents would constitute an infringement of an Intellectual Property Right, then Contractor shall nonetheless be responsible to provide such defense, indemnification and hold harmless if such information is not promptly furnished in writing to County.

### 3.18 **INDEMNIFICATION**

3.18.1 **Contractor's Indemnity Obligation.** To the fullest extent permitted by Applicable Laws, Contractor agrees to indemnify, immediately defend at its own expense and hold harmless, County, Board of Supervisors, and each of their respective members, officers, employees, agents, insurers and volunteers ("Indemnitee(s)"), through legal counsel reasonably acceptable to County, from any and all Losses, whether real or

alleged, regardless of whether caused in part by such Indemnitee or its agents, servants or independent contractors who are directly responsible to such Indemnitee, arising out of or relating to any of the following:

- .1 any act or omission of Contractor or a Subcontractor, of any Tier;
- .2 the activities of Contractor or a Subcontractor, of any Tier, on the Site or on other properties related to performance of the Work or the preparation for performance of the Work;
- .3 the payment or nonpayment of any Subcontractor, of any Tier, for the Work performed, except where such nonpayment is the result of a breach by County of its payment obligations under the Contract Documents;
- .4 the existence or dispersal of any Hazardous Substances or Mold on the Site as a result of the failure of Contractor or a Subcontractor, of any Tier, to comply with its obligations under the Contract Documents;
- .5 the violation by Contractor or a Subcontractor, of any Tier, of an obligation under Section 3.17, above, involving infringement of an Intellectual Property Right; or
- .6 the violation by Contractor or a Subcontractor, of any Tier, of any Applicable Law, including, without limitation, the violation of any requirement of the State of California General Permit for Storm Water Discharges Associated with Construction Activity and subsequent amendments or orders for construction activities as applicable thereto (including, without limitation, the requirements of a Storm Water Pollution Prevention Plan) or the violation of any applicable requirement of any local or regional Air Quality Management District (AQMD) (including, without limitation, a violation of any of the requirements set forth in the County MOU with AQMD dated January 6, 2004 Agenda Item 3.1 (for projects in the Coachella Valley) or AQMD Rule 403 (for projects west of the Coachella Valley));

PROVIDED, HOWEVER, that nothing contained herein shall be construed as obligating Contractor to indemnify an Indemnitee for Losses resulting from the sole negligence, active negligence or willful misconduct of such Indemnitee or its agents, servants or independent contractors who are directly responsible to such Indemnitee or from a defect in design furnished by such Indemnitee, where such sole negligence, active negligence, willful misconduct or design defect has been determined by agreement of Contractor and that Indemnitee or has been adjudged by the final and binding findings of a court or arbitrator of competent jurisdiction. In instances where the active negligence or willful misconduct of an Indemnitee or its agents, servants or independent contractors who are directly responsible to such Indemnitee or a defect in a design furnished by such an Indemnitee accounts for only a portion or percentage of the Loss involved, the obligation of Contractor will be for that portion or percentage of the Loss not due to such active negligence, willful misconduct or design defect.

**3.18.2 Indemnification of Adjacent Property Owners.** In the event the Contractor enters into an agreement with the owners of any adjacent property to enter upon such property for the purpose of performing the Work or other activities incidental to the Work, Contractor shall fully indemnify, defend and hold harmless any person or entity which owns or has any interest in such adjacent property against any Loss resulting from the acts or omissions of the Contractor or its Subcontractors. The form and content of such indemnification agreement shall be approved by County prior to commencement of any Work on or around such property.

**3.18.3 Insurance and Employment Benefits.** The indemnification, defense and hold harmless obligations of Contractor under this Section 3.18, as well as any such obligations stated elsewhere in the Contract Documents: (1) shall not be limited by the amounts or types of insurance (or the deductibles or self-insured retention amounts of such insurance) which any Indemnitee, Contractor or any Subcontractor carries or is required to carry under the terms of the Contract Documents; (2) is independent of and in addition to the Indemnitees' rights under the insurance to be provided by an Indemnitee, Contractor or any Subcontractor; and (3) shall not be limited, in the event of a claim against an Indemnitee by an employee of Contractor, a Subcontractor, anyone directly or indirectly employed by them or anyone for whose acts they may be liable, by a limitation on amount or type of damages, compensation or benefits payable by or for Contractor or Subcontractor under any worker's compensation act, disability benefit act or other employee benefit program.

3.18.4 **Subcontractor Indemnity Agreements.** Contractor agrees to obtain or cause to be obtained executed defense and indemnity agreements with provisions identical to those set forth in this Section 3.18 from each and every Subcontractor, of every Tier.

3.18.5 **Implied Indemnity Rights.** Notwithstanding anything stated in this Section 3.18 or elsewhere in the Contract Documents to the contrary, an Indemnitee's right to seek equitable indemnity and contribution from Contractor is in no way diminished, limited or precluded by any agreement by Contractor to provide express contractual indemnity to such Indemnitee. Contractor's obligations under this Section 3.18 shall be deemed to completely eliminate and preclude any right by Contractor to seek contractual or equitable indemnity or contribution from any Indemnitee for any Loss covered by the Contractor's express indemnification obligations under this Section 3.18.

3.18.6 **Obligation to Defend.** The Contractor's obligation to defend under this Section 3.18 includes, without limitation, the obligation to immediately reimburse an Indemnitee for any attorney's fees, court costs (statutory and non-statutory), arbitration and mediation expenses, professional, expert and consultant fees, investigative costs, postage costs, document copying costs, telecopy costs and any and all other costs and expenses associated with defense of such Indemnitee as and when incurred by any Indemnitee in defense of a claim by any third person or entity as a result of Contractor's failure or refusal to comply with its immediate defense obligation to such Indemnitee. Nothing stated in this Section 3.18 or elsewhere in the Contract Documents shall be interpreted as providing or implying that the obligation of Contractor to defend an Indemnitee against an alleged Loss that is within the scope of the Contractor's indemnification obligation under this Section 3.18 or under any other provision of the Contract Documents is to any extent released, excused, limited or relieved by a finding, determination, award or judgment by a court or arbitrator that the alleged Loss was due to circumstances not within the scope of such indemnification obligation.

3.18.7 **Enforcement.** The Indemnitees shall be entitled to recover their attorneys' fees, costs and expert and consultant costs in pursuing or enforcing a right to defense and/or indemnification under this Section 3.18.

### 3.19 **LABOR, WAGES, PAYROLL RECORDS**

3.19.1 **Public Work.** This Work is a "public work" as defined in Labor Code §1720 and must be performed in accordance with the requirements of Labor Code §§1720 to 1850 and Title 8 California Code of Regulations §§16000 to 17270, which govern the payment of prevailing wage rates on public works projects.

3.19.2 **Prevailing Wage Rates.** Pursuant to the provisions of Article 2 (commencing at §1770), Chapter 1, Part 7, Division 2 of the Labor Code of California, the Board of Supervisors has obtained the general prevailing rate of per diem wages and the general prevailing rate for holiday and overtime Work in the locality in which the Work is to be performed for each craft, classification or type of worker needed to execute the Work from the Director of the Department of Industrial Relations. These rates are on file with County and copies will be made available to any interested party on request. Contractor shall post a copy of such wage rates at the Site. The adoption of such wage rates is not a representation that labor can be obtained at these rates. It is the responsibility of Contractor to inform itself as to the local labor conditions. Holiday and overtime Work, when permitted by Applicable Laws, shall be paid for at a rate of at least one and one-half times the adopted rate of per diem wages, unless otherwise specified. Holidays shall be defined in the collective bargaining agreement applicable to each particular craft, classification or type of worker employed.

3.19.3 **Unclassified Workers.** Any worker employed to perform the Work not covered by any classification listed in the general prevailing wage rate of per diem wages determined by the Director of the Department of Industrial Relations shall be paid not less than the minimum rate of wages specified therein for the classification which most nearly corresponds to the Work to be performed by him/her, and such minimum wage rate shall be retroactive to time of initial employment of such person on the Project in such classification.

3.19.4 **Per Diem Wages.** Contractor shall pay or shall cause to be paid each worker engaged in the Work not less than the general prevailing rate of per diem wages determined by the Director of the Department of Industrial Relations, regardless of any contractual relationship which may be alleged to exist between Contractor or any of the Subcontractors and such workers. Pursuant to California Labor Code §1773.1, per diem wages are deemed to include employer payments for health and welfare, pension, vacation, travel time and subsistence pay.

**3.19.5 Applicable Laws.** Contractor represents and warrants that the Contractor's Bid and the Contract Price includes funds sufficient to allow Contractor to comply with all Applicable Laws governing the labor or services to be provided. Contractor shall defend and indemnify the Indemnitees in accordance with Section 3.18, above, for any violation of any Applicable Law, including but not limited to California Labor Code §2810, and agrees to pay all assessments, including wages and penalties, made against County in relation to such violations.

**3.19.6 Posting at Site.** Contractor shall post at appropriate conspicuous points on the Site the prevailing wage rates of the Department of Industrial Relations in accordance with 8 California Code of Regulations 16100(b).

**3.19.7 Worker Hours.** As provided in Article 3 (commencing at §1810), Chapter 1, Part 7, Division 2 of the California Labor Code, eight (8) hours of labor shall constitute a legal day's work. The standard work day of any worker employed at any time by Contractor or any of the Subcontractors performing the Work, or any part of the Work, shall, except as hereinafter provided, be limited and restricted by Contractor to eight (8) hours per day, between the hours of 6:00 A.M. and 6:00 P.M. (unless otherwise required by Applicable Laws), plus one-half hour unpaid lunch approximately midway through the shift, provided that Contractor or any of the Subcontractors may establish a four day/ten-hour schedule consistent with Applicable Laws pertaining to payment of prevailing wages and the provisions any applicable collective bargaining agreement. A regular-work week shall constitute forty (40) hours during any one week. Notwithstanding the provisions hereinabove set forth, the parties hereto may agree to changes in the work day or the work week as permitted by Applicable Laws, and Contractor and all Subcontractors must pay the appropriate prevailing wage rate for those hours and days worked.

**3.19.8 Overtime.** Overtime work performed by employees of Contractor or any of the Subcontractors shall be compensated according to the applicable general prevailing rate established by the Department of Industrial Relations for holiday and overtime work for each craft, classification or type of worker in the locality in which the Work is to be performed.

**3.19.9 Payroll Records.** It shall be the sole responsibility of Contractor to ensure compliance with the provisions of Applicable Laws and the Contract Documents relating to maintenance and submission of payroll records. Pursuant to the provisions of California Labor Code §1776, Contractor shall keep, and shall cause each Subcontractor performing any portion of the Work to keep, accurate certified payroll records, showing the name, address, social security number, worker classification and straight-time and overtime hours worked each Day and week, and the actual per diem wages paid to each journeyman, apprentice, worker or other employee employed by Contractor in connection with the Work. Certified payroll records must be in the payroll reporting format prescribed by the Division of Labor Standards Enforcement. If there is no work by Contractor or a Subcontractor in a given week, Contractor must keep and submit a certified "Nonperformance" payroll record, indicating "no work" for that week. Contractor shall submit all certified payroll records to County in complete, unredacted form with an original signature on the Statement of Compliance, along with, and as a condition to, its Applications for Payment. Additionally, payroll records shall be available for inspection at all reasonable hours at the principal office of Contractor on the following basis:

**.1** a certified copy of an employee's payroll record shall be made available for inspection or furnished to such employee or his or her authorized representative on request;

**.2** a certified copy of all such payroll records shall be made available for inspection or furnished upon request to County, the Division of Labor Standards Enforcement and/or the Division of Apprenticeship Standards of the Department of Industrial Relations or such other person or entity as designated by County;

**.3** a certified copy of all such payroll records shall be made available upon request by the public for inspection or the copying thereof, provided that (1) such request is made by the public through either County, the Division of Apprenticeship Standards or the Division of Labor Standards Enforcement of the Department of Industrial Relations, (2) such requested payroll records have not previously been provided pursuant to Subparagraph 3.19.9.2, above, then the requesting individual or entity shall, prior to being provided the records, reimburse the costs of preparation by Contractor, the Subcontractors and the entity through which the request was made, and (3) the public shall not be given access to records at the principal office of Contractor;

.4 Contractor and each Subcontractor shall within ten (10) Days after receipt of a written request file a certified copy of such payroll records with the person or entity that requested the records;

.5 Contractor shall provide, and shall cause each Subcontractor to provide, payroll records as defined in Title 8 California Code of Regulations §16000 to County within ten (10) Days after receipt of written request, at no cost to County;

.6 any copy of such payroll records made available for inspection by, and copies furnished to, the public shall be redacted in a manner so as to prevent disclosure of an individual's name, address, and social security number, except that any copy made available for inspection by, and copies furnished to, a joint labor-management committee established pursuant to the federal Labor Management Cooperation Act of 1978 (29 U.S.C. Section 175a) shall be marked or redacted only to prevent disclosure of an individual's name and social security number, and in either event, the name and address of Contractor or the Subcontractor performing the Work shall not be so obliterated; and

.7 any copy made available to an agency included in the Joint Enforcement Strike Force on the Underground Economy established pursuant to Section 329 of the Unemployment Insurance Code and other law enforcement agencies investigating violations of law shall, upon request, be provided nonredacted copies of certified payroll records;

.8 Contractor shall inform County concurrently with the submission of its initial Application for Payment, of the location of such payroll records, including the street address, city and county, and thereafter shall, within five (5) working days, provide a notice of any change of location and address of such payroll records.

**3.19.10 Apprentices.** Contractor acknowledges that, even if performance of the Work involves a dollar amount greater than or a number of working days greater than that specified in California Labor Code §1777.5, it shall be the sole responsibility of Contractor, for all apprentice occupations, to ensure compliance with California Labor Code §1777.5, including, without limitation, the following provisions:

.1 Apprentices of any crafts or trades may be employed and, when required by California Labor Code §1777.5, shall be employed provided they are properly registered in full compliance with the provisions of the California Labor Code.

.2 Every such apprentice shall be paid the prevailing rate of per diem wages for apprentices in the trade to which he or she is registered and shall be employed only at the work of the craft or trade to which he or she is registered.

.3 Only apprentices, as defined in California Labor Code §3077, who are in training under apprenticeship standards and written apprentice agreements under Chapter 4 (commencing at §3070), Division 3 of the California Labor Code, are eligible to be employed at the apprentice wage rate on Public Works. The employment and training of each apprentice shall be in accordance with either: (1) the apprenticeship standards and apprentice agreements under which he or she is training, or (2) the rules and regulations of the California Apprenticeship Council.

.4 Contractor and any of the Subcontractors employing workers in any apprenticeable craft or trade in performing any of the Work shall apply to the applicable joint apprenticeship committee for a certificate approving Contractor or the Subcontractor under the applicable apprenticeship standards and fixing the ratio of apprentices to journeymen employed in performing the Work.

.5 Prior to commencing the Work, Contractor shall submit contract award information to an applicable apprenticeship program that can supply apprentices to the Site of the Work. The information submitted shall include an estimate of journeyman hours to be performed under the Construction Contract, the number of apprentices proposed to be employed, and the approximate dates the apprentices would be employed. A copy of this information shall also be submitted to County if requested by County.

.6 The ratio of the Work performed by apprentices to journeymen employed in a particular craft or trade on the Work may be no higher than the ratio stipulated in the apprenticeship standards under which the apprenticeship program operates, where Contractor or the Subcontractor agrees to be bound by those standards, but,

except as otherwise provided in this Paragraph, in no case shall the ratio be less than one (1) hour of apprentice work for every five (5) hours of journeyman work. Apprentices may comprise up to thirty percent (30%) of the work force of each particular craft, classification or type of worker employed, unless the applicable joint apprenticeship committee establishes a lower percentage. To the extent possible, fifty percent (50%) of the apprentice work force shall consist of first-year apprentices.

.7 The interpretation and enforcement of California Labor Code §1777.5 shall be in accordance with the rules and procedures of the California Apprenticeship Council.

.8 Contractor and all the Subcontractors shall comply with California Labor Code §1777.6, which forbids certain discriminatory practices in the employment of apprentices.

.9 Contractor shall become fully acquainted with the law regarding apprentices prior to commencement of the Work, paying special attention to California Labor Code §§1777.5, 1777.6, and 1777.7 and Title 8, California Code of Regulations, §§200 et seq. Questions may be directed to the State Division of Apprenticeship Standards, 455 Golden Gate Avenue, San Francisco, California.

3.19.11 **Pre-Construction Meetings, Interviews.** Contractor shall attend any pre-construction meetings held by County to discuss labor requirements. Contractor and the Subcontractors shall allow County, County Consultants and the Department of Industrial Relations, and designated representatives of each, to conduct, at their discretion, interviews of workers at the Site during working hours.

#### 3.19.12 **Penalties for Violations.**

.1 **Prevailing Wage Violations.** Pursuant to California Labor Code §1775, Contractor and any of the Subcontractors shall, as a penalty, pay an amount not to exceed Two Hundred Dollars (\$200) for each Day, or portion thereof, for each worker paid less than the prevailing rates, determined by the Director of the Department of Industrial Relations, for the trade or craft in which such worker is employed by Contractor or, except as provided by said §1775, by any of the Subcontractors, of any Tier, for performance of the Work. The amount of this penalty shall be determined by the Labor Commissioner and shall be based on consideration of both: (1) whether the failure of Contractor or the Subcontractor to pay the correct rate of per diem wages was a good faith mistake and, if so, whether the error was promptly and voluntarily corrected upon being brought to the attention of Contractor or the Subcontractor; and (2) whether Contractor or the Subcontractor has a prior record of failing to meet its prevailing wage obligations. The difference between the amount owed to each worker pursuant to such prevailing wage rates, and the amount paid to each worker for each Day or portion thereof for which each worker was paid less than the prevailing wage rate, shall be paid to each worker by Contractor.

.2 **Working Hour Violations.** Pursuant to Labor Code §1813, Contractor shall pay a penalty of Twenty-Five Dollars (\$25) per worker employed in the performance of the Work by Contractor or by any of the Subcontractors for each Day during which such worker is required or permitted to work more than eight (8) hours in any Day and forty (40) hours in any one calendar week in violation of the provisions of Article 3 (commencing at §1810), Chapter 1, Part 7, Division 2 of the California Labor Code.

.3 **Payroll Record Violations.** Pursuant to California Labor Code §1776, Contractor shall in the event of a failure to comply within ten (10) Days with any written notice requesting the records enumerated in subdivision (a) of said §1776, pay a penalty of One Hundred Dollars (\$100) for each Day, or portion thereof, for each worker, until Contractor has strictly complied with such request. Upon the request of the Division of Apprenticeship Standards or the Division of Labor Standards Enforcement, these penalties shall be withheld from progress payments then due.

.4 **Apprenticeship Violations.** Pursuant to California Labor Code §1777.7, if Contractor or the Subcontractor is determined by the Chief of the Division of Apprenticeship Standards (the "Chief") to have knowingly committed a first-time violation of California Labor Code §1777.5, Contractor or the Subcontractor shall pay, as a civil penalty, an amount not exceeding One Hundred Dollars (\$100) for each full Day of noncompliance, provided that the amount of this penalty may be reduced by the Chief if the penalty would be disproportionate to the severity of the violation. In lieu of this penalty, the Chief may, for a first-time violation and with the concurrence of the joint apprenticeship committee, order Contractor or the Subcontractor to provide apprentice employment equivalent to the

work hours that would have been provided for apprentices during the period of noncompliance. If such violation by Contractor or the Subcontractor is a second or subsequent violation committed within a three (3) year period from a previous violation of §1777.5, Contractor or the Subcontractor shall pay, as a civil penalty, to County the sum of not more than Three Hundred Dollars (\$300) for each full Day of noncompliance. County shall withhold the amount of the civil penalty from contract progress payments then due or to become due. In addition, if Contractor or the Subcontractor is determined to have knowingly committed a serious violation of any provision of §1777.5, the Chief may deny to Contractor or the Subcontractor, and to its responsible officers, the right to bid on or be awarded a contract to perform work as a subcontractor on any subsequent project for County for a period of up to one (1) year for the first violation and for a period of up to three (3) years for a second or subsequent violation.

**3.19.13 Subcontractor Provisions.** Contractor shall include, and shall require the Subcontractors to include, contractual provisions in all contracts they enter into for the performance of the Work requiring compliance with the provisions of this Section 3.19 at no additional cost.

**3.19.14 Condition of Payment.** Compliance by Contractor with the requirements of this Section 3.19 and each of its Paragraphs shall be a condition to Contractor's right to payment under its Applications for Payment. Without limitation to the foregoing, payments to Contractor shall not be made when payroll records are delinquent or inadequate.

### **3.20 LABOR CODE §2810**

**3.20.1 Application.** The provisions of this Section 3.20 apply only if the Contractor has not executed a collective bargaining agreement covering the workers who will be employed to perform the Work.

**3.20.2 Declaration by Contractor.** If a Declaration of Sufficiency of Funds has not been submitted by Contractor as a Post-Award Submittal, then it must be submitted prior to Award. In executing the Construction Contract, Contractor warrants and represents that all of the statements contained in its Declaration of Sufficiency of Funds remain true and correct as of the date of execution of the Construction Contract and may be relied upon by County in determining whether there appears to be sufficient funds in the Contractor's Bid to allow the Contractor to comply with all Applicable Laws governing the labor or services to be provided for the performance of the Work. The truth and accuracy of the statements contained in said Declaration and in this Paragraph 3.20.2 constitute a material part of the Contractor's consideration for, and a material inducement to the County's entering into, the Construction Contract.

**3.20.3 Continuing Duty.** To the extent that any of the information provided in the Declaration of Sufficiency of Funds submitted by Contractor relating to numbers of workers or independent contractors that will be employed or utilized for performance of the Work was or is based upon a best estimate, rather than actual figures or information, then the Contractor assumes the continuing duty to the County to ascertain the actual figures and information requested in the Declaration of Sufficiency of Funds and to provide such actual figures and information to the County in the form of a revised and updated Declaration of Sufficiency of Funds once the actual figures and information become known.

### **3.21 URBAN RUNOFF AND STORM WATER COMPLIANCE**

**3.21.1 Contractor's Responsibility.** If and to the extent storm water permitting, control, mitigation or discharge control is required by Applicable Laws, the Contractor shall: (1) prior to starting any Work at the Site, sign and implement the Storm Water Management Plans or Storm Water Pollution Prevention Plans as previously prepared by the County's Consultant for civil engineering or by others; (2) take all necessary steps to monitor, report, enforce and otherwise implement and comply with the requirements of the Storm Water Permit, Storm Water Management Plans and Storm Water Pollution Prevention Plans and all Applicable Laws pertaining to the elimination or mitigation of storm water pollutant discharge to separate storm sewer systems or other watercourses, including without limitation, applicable requirements of the State Water Resources Control Board, Santa Ana, San Diego, and/or Colorado Region Water Quality Control Boards and municipal storm water management programs; (3) adhere to and implement the Special Provisions for Urban Runoff and Water Pollution Control set forth in the Specifications; and (4) ensure that the Work is constructed in conformance with those post-construction best management practices (BMPs) identified within the project-specific Water Quality Management Plan (WQMP).

3.21.2 **Inspections, Reports.** Contractor shall immediately notify the person identified to Contractor as the County's "project manager" for the Project of all inspections by Government Authorities (including, but not limited to, any regional board staff) and, if practicable, arrange for participation by such Governmental Authorities in any other pertinent inspections conducted at the Site. Contractor shall provide to County copies of all reports and monitoring information related to the matters covered by this Section 3.21.

3.21.3 **Violations.** The Contractor recognizes and understands that failure to comply with the requirements of any applicable storm water-related permit issued by the State of California of the United States pursuant to the Clean Water Act (Title 33 U.S.C. §§ 1251 et seq) and/or the Porter Cologne Water Quality Control Act (California Water Code §§13000 et seq.) is a violation of Applicable Laws. Contractor shall be responsible for all Losses and for any liability (including, without limitation, fines, penalties and other administrative liabilities and costs) imposed by Applicable Laws as a result of the Contractor's failure to comply with Applicable Laws, including, without limitation, the requirements of this Section 3.21.

3.21.4 **Condition of Payment.** Compliance by the Contractor with the requirements of this Section 3.21 shall be a condition to the Contractor's right to payment under its Applications for Payment.

3.21.5 **Costs of Compliance.** The Contractor represents and warrants that it has included in its Bid all costs of compliance with the requirements of this Section 3.21.

### 3.22 **SOLID WASTE MANAGEMENT**

Contractor shall comply with all provisions of Applicable Laws (including, without limitation, the requirements of the California Public Resources Code, rules and regulations of the California Integrated Waste Management Board and provisions of any Site-specific plans adopted by County) that are applicable to the activities of contractors performing construction or related activities on the Site. Compliance by Contractor with the requirements of this Section 3.22 shall be a condition to Contractor's right to payment under its Applications for Payment.

### 3.23 **CEQA COMPLIANCE**

No Work that is subject to California Environmental Quality Act (CEQA) shall proceed by Contractor until Contract Documents satisfying the CEQA process are reviewed and approved by the County. Contractor shall comply with all applicable CEQA requirements. If there is a federal nexus (e.g. a source of federal funding) to the Project, compliance by Contractor with the National Environmental Policy Act (NEPA) will be required in addition to and in conjunction with compliance with requirements of CEQA. The Contractor shall comply with the conditions identified on the Plans and Specifications for compliance with the California Environmental Quality Act, including, without limitation, all requirements pertaining to Mitigation, Monitoring, and Reporting Program (MMRP).

### 3.24 **AQMD COMPLIANCE**

Contractor is responsible for full and complete compliance with, as applicable: (1) AQMD Rule 403.1, County Ordinance 742, the County MOU with AQMD dated January 6, 2004 Agenda Item 3.1 (for projects in the Coachella Valley); or (2) AQMD Rule 403 (for projects west of the Coachella Valley). Any fines imposed by AQMD on the County, as well as any other Loss to County, as a result of non-compliance by Contractor with the applicable provisions of the foregoing requirements are the responsibility of Contractor and upon request by County will be paid to County by Contractor or may be withheld by County from amounts due to Contractor under its Applications for Payment.

## **ARTICLE 4 CONSTRUCTION ADMINISTRATION**

### 4.1 **ARCHITECT**

4.1.1 **Scope of Authority.** The Architect shall have the authority to act on behalf of County only as expressly provided in the Contract Documents and subject to such limitations on authority as set forth in Paragraph 4.1.2, below. As clarification of the foregoing, if the Contract Documents provide that the Architect has the right to approve of, consent to or direct that Contractor take or forbear from taking an action, such authority shall be limited to



issuing such approval, consent or direction and shall not include, or be interpreted to include, authority to bind County with respect to any of the matters set forth in Paragraph 4.1.2, below. If Contractor's compliance with such approval, consent or direction of the Architect would involve or require authorization by County within the scope of the matters set forth in Paragraph 4.1.2, below, Contractor has the obligation, in addition to complying with the Architect's approval, consent or direction, to take steps in accordance with the Contract Documents to obtain such authorization of County as may be required and failing to do so shall not have any right to recourse or recovery from County on account of Contractor's action taken or Work performed in response to such approval, consent or direction by Architect.

**4.1.2 Limitations on Authority.** Without limitation to the other limitations on the Architect's authority expressed or implied under Paragraph 4.1.1, above, and notwithstanding anything else set forth in the Contract Documents to the contrary, Architect does not have authority to: (1) obligate or commit County to any payment of money; (2) obligate County to any adjustment to the Contract Price or Contract Time; (3) relieve Contractor of any of its obligations under the Contract Documents; (4) approve or order any Work involving Delay or Extra Work; or (5) perform any act, make any decision or give any direction or approval that is described in these General Conditions as an act, decision, direction or approval that is to be performed, made or given by any person or entity other than Architect.

**4.1.3 Work Stoppage.** Architect's authority includes, without limitation, the authority to stop the Work whenever such stoppage may be necessary, in Architect's opinion, for the proper execution of the Work. Any Work that is stopped or disapproved by order of Architect shall be resumed if and when County so directs in writing, with or without the concurrence of the Architect.

**4.1.4 Replacement.** County may, in its sole discretion, substitute another person or entity, or add persons or entities, to perform the functions of Architect or to exercise some or all of the authority of Architect provided for in the Contract Documents.

**4.1.5 County Rights.** All rights and authority conferred upon Architect under the Contract Documents constitute rights that County may, in its sole and absolute discretion, exercise in writing on its own behalf, irrespective of whether the County has ordered the removal, replacement or a change in the authority of the Architect.

## **4.2 ADMINISTRATION OF THE WORK ORDER CONTRACT**

**4.2.1 Observations of the Work.** Architect will visit the Site as appropriate to the stage of the Work to observe the Work in progress. Observations shall be for the purpose of ascertaining the progress of the Work and that the character, scope, quality and detail of construction (including workmanship and materials) comply with the Contract Documents, the Architect's directives, approved Submittals and clarifications issued by Architect. Observations shall be separate from any inspections which may be provided by others.

**4.2.2 Means, Methods.** Construction means, methods, techniques, sequences, procedures and safety precautions and programs in connection with the Work are solely the responsibility of Contractor. Neither County nor Architect: (1) has control over or charge of, nor are they responsible for, Contractors or any Subcontractor's construction means, methods, techniques, sequences, procedures, safety precautions or programs in connection with the Work, all of which are, as between Contractor and County, solely Contractor's responsibility; (2) is responsible for Contractor's failure to carry out the Work in accordance with the Contract Documents; or (3) has control over, charge of, or responsibility for acts or omissions of Contractor, the Subcontractors or their agents or employees, or of any other persons performing portions of the Work.

**4.2.3 Communications by Contractor.** County shall be provided by Contractor with copies of all communications from Contractor or the Subcontractors to Separate Contractors or the Architect. Contractor shall not rely on oral or other non-written communications.

**4.2.4 Review of Applications for Payment.** If requested by County, Architect will review and certify all Applications for Payment by Contractor, including Applications for Payment requesting Progress Payments and Final Payment. In such cases, if the Architect and County do not concur in respect to the amount to be paid to Contractor, County's determination of the amount due will prevail.

**4.2.5 Rejection of the Work.** Architect will have authority to reject Work that does not conform to the Contract Documents and to require additional inspection or testing, in accordance with Article 10, below, whether or not such Work is fabricated, installed or completed. Whenever Architect considers it necessary or advisable for implementation of the intent of the Contract Documents, Architect will have authority to require additional inspection or testing of the Work in accordance with Article 10, below, whether or not such Work is fabricated, installed or completed. Neither Architect's authority to act under this Paragraph 4.2.5 nor a decision made in good faith either to exercise or not to exercise such authority, shall give rise to a duty or responsibility of Architect to Contractor, the Subcontractors, their agents or employees, or other persons performing any of the Work. County shall have the right, notwithstanding a recommendation by the Architect pursuant to this Paragraph 4.2.5 to reject a portion of the Work, to elect to accept the Work rejected by Architect and to direct in writing the manner in which the Work is to be performed and Contractor shall comply therewith.

**4.2.6 Review of Submittals.** Architect and such other County Consultants as Architect or County determines appropriate will review, approve or take other appropriate action upon the Contractor's Submittals. Such review, approval and other action taken in regard to a Submittal is for the limited purpose of checking for conformance with information given and the design concept expressed in the Contract Documents and is not conducted for the purpose of determining the technical accuracy and completeness of the Submittal, checking details such as dimensions and quantities, or for substantiating instructions for installation or performance of equipment or systems, all of which remain the sole responsibility of Contractor. Actions by Architect and County Consultants in connection with review of a Submittal by Contractor will be taken with such promptness as to cause no unreasonable Delay in the Work of Contractor or in the activities of the Separate Contractors or County, while allowing sufficient time in their judgments to permit adequate review. Whether or not County has identified a particular Submittal for review by Architect or a County Consultant, Contractor shall in all cases submit Submittals sufficiently in advance to allow time to permit adequate review by Architect and other County Consultants. Neither Architect's nor any County Consultant's review of a Submittal shall: (1) relieve Contractor of its obligations under Section 3.11, above; (2) constitute approval of safety precautions or, unless otherwise specifically stated in writing by the Architect or County Consultant at the time such Submittal is returned to Contractor; (3) be construed as an approval of any construction means, methods, techniques, sequences or procedures; and (4) if it involves review or approval of a specific item, be construed as indicating approval of an assembly of which such item is a component.

**4.2.7 Changes.** After consultation with the Architect, County will prepare the Change Orders, Unilateral Change Orders, Unilateral Work Orders and Construction Change Directives for execution and take appropriate action thereon in accordance with Article 7, below.

### **4.3 CLAIMS**

**4.3.1 Submission of Claims.** All Claims by Contractor shall be submitted in accordance with the procedures set forth in this Section 4.3.

#### **4.3.2 Arising of Claim.**

**.1 Changes.** A Claim by Contractor involving a Contract Adjustment due to a Compensable Change or Deleted Work arises upon issuance of a decision denying, in whole or in part, Contractor's Change Order Request. Such Claim shall be prepared and submitted in accordance with the requirements of this Section 4.3, including, without limitation, Paragraphs 4.3.3 through 4.3.5, below.

**.2 Other Claims.** Claims by Contractor other than those described in Subparagraph 4.3.2.1, above, arise at the time that County receives written notice by Contractor of Contractor's intent to file the Claim. Such notice of intent shall be given no later than five (5) Days after the Discovery Date relative to such circumstances (even if Contractor has not yet experienced a Loss or Delay due to such circumstances) and shall state the event or condition giving rise to the Claim and its probable effect, if any, upon the Contract Price and Contract Time. **FAILURE BY CONTRACTOR TO SUBMIT A NOTICE OF INTENT TO FILE CLAIM IN ACCORDANCE WITH THIS SUBPARAGRAPH 4.3.2.2 SHALL, IN ACCORDANCE WITH THE PROVISIONS OF SECTION 4.6 OF THE GENERAL CONDITIONS, CONSTITUTE A WAIVER BY CONTRACTOR OF THE RIGHT TO FURTHER RECOURSE OR RECOVERY UPON SUCH CLAIM.**

**4.3.3 Content of Claims.** A Claim must include the following:

.1 a statement that it is a Claim and a request for a decision on the Claim;

.2 a detailed description of the act, error, omission, unforeseen condition, event or other circumstance giving rise to the Claim;

.3 supporting documentation as follows: (1) if the Claim involves a Contract Adjustment due to Compensable Change or Deleted Work, documentation demonstrating that a complete Notice of Change and Supplemental Work Order, Change Order Request were timely and properly submitted as required by Article 7, below; (2) if the Claim involves an adjustment to the Contract Time, documentation demonstrating that a complete Notice of Delay and Request for Extension were timely and properly submitted as required by Article 7 and Article 8, below; and (3) if the Claim does not involve a Contract Adjustment on the basis of Compensable Change or Deleted Work, documentation demonstrating that a notice of intent to file the Claim was timely and properly submitted as required by Subparagraph 4.3.2.2, above;

.4 a detailed justification for any remedy or relief sought by the Claim, including, without limitation, all of the following: (1) a detailed cost breakdown in the form required for submittal of Supplemental Work Order, Supplemental Work Order Proposals, which complies with the prohibition on "total cost" calculations set forth in Paragraph 7.7.15, below; and (2) job cost records substantiating the actual costs that have been incurred; and

.5 a written certification, signed by a responsible managing officer or principal of Contractor's organization who has the authority to sign contracts on behalf of Contractor and who has personally investigated the matters alleged in the Claim, in the following form:

"I hereby certify under penalty of perjury that I am a managing officer or principal of (Contractor) and that I have reviewed the Claim presented herewith on Contractor's behalf and/or on behalf of (Subcontractor(s)) and that the following statements are, to the best of my knowledge after diligent inquiry into the circumstances of such Claim, true and correct:

(i) the facts alleged in or that form the basis for the Claim are true and accurate;

(ii) I do not know of any facts or circumstances, not alleged in the Claim, that by reason of their not being alleged render any fact or statement alleged in the Claim materially misleading;

(iii) I have, with respect to any request for money or damages alleged in or that forms the basis for the Claim, reviewed the job cost records (including those maintained by Contractor and by any Subcontractor, of any Tier, that is asserting all or any portion of the Claim) and confirmed with reasonable certainty that the losses or damages alleged to have been suffered by Contractor and/or such Subcontractor were in fact suffered in the amounts and for the reasons alleged in the Claim;

(iv) I have, with respect to any request for extension of time or claim of delay, disruption, hindrance or interference alleged in or that forms the basis for the Claim, reviewed the job schedules (including those maintained by Contractor and by any Subcontractor, of any Tier, that is asserting all or any portion of the Claim) and confirmed that the delays or disruption alleged to have been suffered by Contractor and/or such Subcontractor were in fact experienced for the durations, in the manner, and with the consequent effects on the time and/or sequence of performance of the Work, as alleged in the Claim; and,

(v) Contractor has not received payment from County for, nor has Contractor previously released County from, any portion of the Claim.

Signature: \_\_\_\_\_

Name: \_\_\_\_\_

Title: \_\_\_\_\_

Company: \_\_\_\_\_

Date: \_\_\_\_\_

**4.3.4 Noncompliance.** Failure by Contractor to comply with Paragraph 4.3.3, above, shall give County the right, without obligation, to deny the Claim or return the Claim without any response.

**4.3.5 Submission of Claims.**

**.1 Time for Filing.** All Claims and supporting documentation and certifications required to be submitted by Contractor must be submitted to the County within thirty (30) Days after the Claim arises (as "arises" is defined in Paragraph 4.3.2, above). No Claims by Contractor are permitted after Final Payment.

**.2 Condition Precedent.** Contractor's strict compliance with the requirements of this Section 4.3 as to a Claim shall be considered a condition precedent to Contractor's right to initiate or seek determination of its rights in any legal proceedings with respect to such Claim.

**4.3.6 Response to Claims by Contractor.**

**.1 Claims under \$50,000.** Claims by Contractor that are less than Fifty Thousand Dollars (\$50,000) shall be responded to by County by issuance of a Good Faith Determination of the Claim in writing within forty-five (45) Days of receipt of the Claim, unless County requests additional information or documentation of the Claim within thirty (30) Days of receipt of the Claim, in which case County shall respond to the Claim after receipt of the further information or documentation by issuing its Good Faith Determination of the Claim within the longer of either (1) fifteen (15) Days, or (2) the period of time taken by Contractor in producing the additional information or documentation.

**.2 Claims over \$50,000.** Claims by Contractor that are over Fifty Thousand Dollars (\$50,000) shall be responded to by County by issuance of a Good Faith Determination of the Claim in writing within sixty (60) Days of receipt of the Claim, unless County requests additional information or documentation of the Claim within thirty (30) Days of receipt of the Claim, in which case County shall respond to the Claim after receipt of the further information or documentation by issuing its Good Faith Determination within the longer of either (1) thirty (30) Days, or (2) the period of time taken by Contractor in producing the additional information or documentation.

**4.3.7 Meet and Confer.** If Contractor disputes County's Good Faith Determination of a Claim by Contractor, or if County fails to respond within the prescribed time set forth in Paragraph 4.3.6, above, Contractor may so notify County, in writing, within fifteen (15) Days of Contractor's receipt of County's Good Faith Determination, or within fifteen (15) Days of County's response due date in the event of a failure to respond, and demand an informal conference to meet and confer for settlement of the issues in dispute. Upon demand, County shall schedule a meet and confer conference within thirty (30) Days of such demand for discussion of settlement of the dispute. If either County or Contractor determines that the meet and confer process has not been successful, it shall have the right to declare the meet and confer process closed by written notice to the other party so stating.

**4.3.8 Claims Based on Differing Site Conditions.**

**.1 Contractor Responsibility.** Save and except as hereinafter provided in this Paragraph 4.3.8 for Contract Adjustments due to Differing Site Conditions, Contractor agrees at Contractor's Own Expense to assume the risk and costs of Extra Work and Delay due to concealed or unknown conditions, surface or subsurface, at the Site or in Existing Improvements.

**.2 Differing Site Conditions.** Differing Site Conditions are those conditions at the Site or in Existing Improvements and not otherwise reasonably ascertainable by Contractor in the performance of its obligations under the Contract Documents (including, without limitation, conditions not reasonably ascertainable by Contractor from documents or information described in Paragraph 3.2.1, above, that were provided or available to Contractor for its review prior to the Bid Closing Deadline) that constitute: (1) hazardous materials that constitute hazardous waste, as defined in California Health and Safety Code §25117, that is required to be removed to a Class I, Class II, or Class III disposal site in accordance with provisions of Applicable Laws; (2) subsurface or concealed conditions at the Site or concealed conditions in Existing Improvements which differ materially from those indicated by the Contract Documents or other information that was either reviewed by Contractor or that Contractor was given the opportunity to review prior to the Bid Closing Deadline; or (3) unknown physical conditions at the Site or concealed conditions in Existing Improvements of an unusual nature, differing materially from those ordinarily encountered and generally recognized as inherent in work of the character provided for in the Contract Documents.

**.3 Notice of Change.** If Contractor encounters conditions it believes constitute Differing Site Conditions, then Contractor shall, before such conditions are disturbed, give Notice of Change as required by Paragraph 7.6.1, below, stating, without limitation, a detailed description and precise location of the conditions encountered.

**.4 Investigation by County.** Upon receipt of notice from Contractor as required by Subparagraph 4.3.8.3, above, County shall promptly investigate Contractor's report of Differing Site Conditions.

**.5 Supplemental Work Order Proposal.** If Contractor intends to seek a Contract Adjustment based upon Differing Site Conditions that may be encountered it shall submit a complete and timely Supplemental Work Order Proposal Request in accordance with Paragraph 7.6.2, below, setting forth its request for a Contract Adjustment.

**.6 Contract Adjustments.** If, following Contractor's compliance with its obligations under this Paragraph 4.3.8, County finds that Differing Site Conditions exist, then, unless the Contractor's right to Contract Adjustment has been waived as pursuant to Paragraph 3.2.3, above, a Supplemental Work Order Contract Adjustment shall be made by issuing a County Change Order to which the Supplemental Work Order will serve as minimally required back-up, for the resulting Compensable Change and Compensable Delay, in such amount and duration as County determines by issuance of a Good Faith Determination are reasonable and permitted by these General Conditions.

#### **.7 WAIVER BY CONTRACTOR.**

**FAILURE BY CONTRACTOR TO STRICTLY COMPLY WITH THE REQUIREMENTS OF THIS PARAGRAPH 4.3.8 PERTAINING TO CONTRACT ADJUSTMENT BASED ON A CLAIM FOR DIFFERING SITE CONDITIONS SHALL, IN ACCORDANCE WITH THE PROVISIONS OF SECTION 4.6 OF THE GENERAL CONDITIONS, CONSTITUTE A WAIVER BY CONTRACTOR OF THE RIGHT TO FURTHER RECOURSE OR RECOVERY UPON SUCH CLAIM.**

**.8 Final Completion.** No claim by Contractor for additional compensation for Differing Site Conditions shall be allowed if asserted after Final Payment.

**4.3.9 Continuous Work.** Contractor shall, notwithstanding the existence of a Claim by Contractor that is disputed by County, maintain continuous performance, without interruption, suspension or slowing, of the Work and its other obligations (1) pending issuance by County of a Good Faith Determination—of the Claim and (2) thereafter in compliance with the terms of such Good Faith Determination.

#### **4.4 ATTORNEY'S FEES**

If any legal action, arbitration or other legal proceeding is brought in connection with or related to the interpretation, performance or enforcement of the Contract Documents or the performance or nonperformance of the Work, including, but not limited to, an action to rescind the Construction Contract, the prevailing party therein shall be entitled to recover from the other party the prevailing party's actual costs, expenses and attorneys' fees at arbitration, mediation, trial and on appeal. The determination of the "prevailing party" shall be based upon the party who prevails

upon the matters actually litigated or arbitrated and shall not be determined solely based on the party receiving a net monetary recovery.

#### 4.5 NOTICE OF THIRD-PARTY CLAIMS

County shall provide notification to Contractor within a reasonable time after receipt of any third-party claim relating to the Construction Contract. County shall be entitled to recover from Contractor its reasonable costs of providing such notification.

#### 4.6 WAIVERS OF RIGHTS BY CONTRACTOR

**COUNTY AND CONTRACTOR ACKNOWLEDGE THAT IT IS IN THE INTERESTS OF BOTH PARTIES THAT CHANGES, DELAYS AND CLAIMS BE IDENTIFIED, QUANTIFIED, EVALUATED AND FINALLY RESOLVED PROMPTLY, CONTEMPORANEOUSLY WITH THE CIRCUMSTANCES FROM WHICH THEY ARISE, AND THAT THERE BE CERTAINTY WITH RESPECT TO THE FINALITY OF ANY RESOLUTION OF RELATED DISPUTES. ON THOSE PREMISES, AND IN FURTHER RECOGNITION OF THE FACT THAT IT WOULD BE EXTREMELY DIFFICULT OR IMPOSSIBLE TO QUANTIFY, DEMONSTRATE OR PROVE THE HARM TO COUNTY IF ANY OF THE FOREGOING PREMISES IS NOT ACHIEVED DUE TO A FAILURE BY CONTRACTOR TO COMPLY WITH THE REQUIREMENTS OF THE CONTRACT DOCUMENTS CONCERNING TIMELY NOTICE OR SUBMISSIONS OF NOTICES AND CLAIMS RELATING TO CHANGES, DELAY AND CONTRACT ADJUSTMENTS, COUNTY AND CONTRACTOR AGREE THAT FAILURE BY CONTRACTOR TO CONFORM TO SUCH REQUIREMENTS OF THE CONTRACT DOCUMENTS SHALL IN AND OF ITSELF CONSTITUTE SUFFICIENT CAUSE AND GROUNDS, WITHOUT THE NECESSITY OF COUNTY DEMONSTRATING ANY ACTUAL HARM OR PREJUDICE, FOR IMPOSING UPON CONTRACTOR A FULL AND UNCONDITIONAL WAIVER BY CONTRACTOR OF ITS RIGHT TO A CONTRACT ADJUSTMENT AND OF ITS RIGHTS AND RECOURSE FOR RECOVERY OF ANY RELATED LOSS BY ANY LEGAL PROCESS OTHERWISE PROVIDED FOR UNDER APPLICABLE LAWS.**

#### 4.7 GOOD FAITH DETERMINATIONS

Wherever in the Contract Documents it is provided that the County may or shall make a determination or decision in the exercise of good faith (including, without limitation, provisions for a Good Faith Determination by County), any such determination or decision that the person exercising such right on behalf of County believes in good faith to be a proper exercise of County's rights and to have a reasonable basis in fact, whether or not such determination is in fact proper, reasonable or correct or adjudged to be so, shall be complied with by Contractor without Delay to Contractor's performance of the Work. However, unless the Contract Documents expressly provides otherwise, neither such good faith determination or decision nor Contractor's compliance therewith shall be interpreted as precluding the Contractor from exercising its rights to seek adjudication of its rights in the manner permitted by these General Conditions or Applicable Laws.

#### 4.8 ESCROW BID DOCUMENTS

If the NJPA Bidding Documents obligate Contractor to submit Escrow Bid Documents, then submission by Contractor of its Escrow Bid Documents shall constitute a warranty and representation by Contractor that it has no other written documents or electronic files containing any information that Contractor was required to include, but failed to include, as part of its performing such obligation and Contractor agrees it shall have no right to submit for consideration by County, or offer into evidence in legal proceedings, in support of a request for Contract Adjustment or a Claim any such documentation or electronic files that Contractor so failed to include in its Escrow Bid Documents.

### ARTICLE 5 SUBCONTRACTORS

#### 5.1 SUBSTITUTION

5.1.1 **Substitutions Allowed.** There shall be no substitution of or addition to the Subcontractors except as permitted by Chapter 4 (commencing at §4100), Division 2, Part 1 of the California Public Contract Code (the "Act").

5.1.2 **Contractor's Own Expense.** Any increase in the cost or time of performance of the Work resulting from the replacement, substitution or addition of a Subcontractor shall be borne solely by Contractor at Contractor's Own Expense.

5.1.3 **Substantiation of Compliance.** At any time during performance of the Work it shall be the responsibility and burden of Contractor, if requested by County, to present clear and convincing evidence that Contractor is, and all times during the bidding and Award of the Construction Contract was, in full compliance with all of the applicable provisions of the Act. Failure by Contractor to present such evidence when requested shall be deemed a breach of this Section 5.1 and of the Act, thereby entitling County to exercise any or all of its rights and remedies under the Contract Document or Applicable Laws, including, without limitation, the right to cancel the Construction Contract or assess any penalties provided for by the Act.

5.1.4 **Splitting Prohibited.** Any attempt by Contractor to avoid compliance with the Act, such as, but not limited to, by splitting the work of subcontracts with Subcontractors into separate contracts or changes orders so as to not exceed the monetary threshold of the Act applicable to listing of Subcontractors, is strictly prohibited.

## 5.2 SUBCONTRACTUAL RELATIONS

5.2.1 **Written Agreements.** Contractor shall, by written agreement entered into between the Contractor and Subcontractors no later than twenty (20) Days (or less if so indicated by the County on the Request for Proposal document for each individual Work Order) after Award, require each Subcontractor, to the extent of the Work to be performed by the Subcontractor, to be bound to Contractor by terms of the Contract Documents and to assume toward Contractor all the obligations and responsibilities which Contractor, by the Contract Documents, assumes toward County and the Architect. Each subcontract agreement shall preserve and protect the rights of County and the Architect under the Contract Documents with respect to the Work to be performed by the Subcontractor so that subcontracting thereof will not prejudice such rights, and shall allow the Subcontractor, unless specifically provided otherwise in the subcontract agreement, the benefit of all rights, remedies and redress against Contractor that Contractor, by the Contract Documents, has against County. Contractor shall require each first-Tier Subcontractor to enter into similar agreements with their sub-subcontractors. Copies of applicable portions of the Contract Documents shall be made available by Contractor to the first-Tier Subcontractors and each Subcontractor shall similarly make copies of such Contract Documents available to each Subcontractor of a lower-Tier with which it contracts. Without limitation to the foregoing, each contract that is entered into by a Subcontractor, of any Tier, shall, without limitation, require the Subcontractor:

- .1 to perform the Work in accordance with the terms of the Contract Documents;
- .2 to assume toward Contractor all the obligations and responsibilities which Contractor assumes toward County by the Contract Documents;
- .3 to preserve and protect the rights of County under the Contract Documents with respect to the Work to be performed by the Subcontractor so that subcontracting thereof will not prejudice such rights;
- .4 to waive all rights (including, without limitation, rights of subrogation) that the Subcontractor or its insurers may have against County and others required by the Contract Documents to be named as additional insured, for Losses covered by insurance carried by Contractor or County, except for such rights as the Subcontractor may have to the proceeds of such insurance held by County or such other additional insured;
- .5 to afford County and entities and agencies designated by County the same rights and remedies afforded to them under the Contract Documents with respect to access to, and the right to audit and copy at County's cost, all of the Subcontractor's books, records, contracts, correspondence, instructions, drawings, receipts, vouchers, purchase orders, memoranda and other records and documents relating to the Work and requiring the Subcontractor to preserve all such records and other items for a period of ten (10) years after Final Completion;
- .6 to recognize the rights of the County under Section 5.3, below, including, without limitation, the County's right to (1) accept assignment of the Subcontractor's agreement, (2) accept assignment of Contractor's rights as obligee under a performance bond furnished by a first-Tier Subcontractor, (3) to retain the Subcontractor pursuant to the terms of its agreement with Contractor to complete the unperformed obligations under its agreement,

and, (4) if requested by the County, to require that the Subcontractor execute a written agreement on terms acceptable to the County confirming that the Subcontractor is bound to the County under the terms of its agreement with Contractor;

.7 to submit applications for payment, requests for change orders and extensions of time and claims, and to comply with all other notice and submission requirements of the Contract Documents, sufficiently in advance to allow Contractor time to comply with its obligations under the Contract Documents;

.8 to purchase and maintain insurance in accordance with the requirements of the Contract Documents;

.9 to defend and indemnify the Indemnitees on the same terms as provided in Section 3.18, above;

.10 to comply with the nondiscrimination (Article 16, below) and prevailing wage (Section 3.19, above) provisions of these General Conditions;

.11 limiting the Subcontractor's right to additional compensation or extension of time due to Differing Site Conditions and Design Discrepancies in accordance with the provisions of Section 3.2, above;

.12 to provide for a right of termination for convenience by Contractor that limits the Subcontractor's right to compensation to an allocable share of the subcontract price that corresponds to the percentage of the Work properly performed by the Subcontractor, with no additional sum payable for any other Losses, including, without limitation, prospective damages, lost profits or consequential damages, of any kind; and

.13 to provide that time is of the essence to each of the Subcontractor's obligations.

**5.2.2 Copies.** Contractor shall, upon request by County made at any time, furnish to County true, complete, and executed copies of all contracts with the Subcontractors and amendments, modifications and change orders thereto. Progress payments shall not be made for items of the Work for which County has not received such documents following request therefor by County.

**5.2.3 No Brokering.** Contractor shall not permit any portion of the Work to be contracted to a firm acting as a broker, factor or other entity not actually performing a substantial portion of the Work with its own forces; provided, however, that nothing herein shall be interpreted as precluding the right of a Subcontractor who has agreed to provide all of the materials and labor for a trade to subcontract the labor portion only to a sub-subcontractor.

**5.2.4 Third-Party Rights.** Contractor acknowledges that County is an intended third-party beneficiary to all contracts between Contractor and its first-Tier Subcontractors. Notwithstanding the foregoing or anything else to the contrary in the Contract Documents, there is no intent on the part of County or Contractor to create any rights (including, without limitation, third-party beneficiary rights) in favor of any Subcontractor, of any Tier, against County and nothing contained in the Contract Documents and no course of conduct, act or omission on the part of County shall be construed as creating a direct or indirect contractual right in favor of any Subcontractor, of any Tier, and against County.

**5.2.5 All Subcontractor Tiers.** It is the Contractor's obligation to see to it that all obligations of the Contractor are assumed by (or, "flow down") to the Subcontractors, of every Tier, by the inclusion of contractual provisions requiring each of the Subcontractors, of every Tier, to bind not only themselves but their lower-Tier Subcontractors to the obligations assumed by Contractor under the Contract Documents.

### **5.3 CONTINGENT ASSIGNMENT OF SUBCONTRACTS**

**5.3.1 Contingent Assignment.** Contractor hereby contingently assigns to County, or to such person or entity as County, in its sole and absolute discretion, designates, all of its interest in subcontracts entered into by Contractor with its first-Tier Subcontractors. If a first-Tier Subcontractor has provided a performance bond, then Contractor's rights under such performance bond are likewise hereby deemed contingently assigned to County



or its designee and provision shall be made in the performance bond for surety's consent to such contingent assignment.

**5.3.2 Acceptance by County.** The contingent assignments provided for by this Section 5.3 will be effective only as to those subcontracts and performance bonds which County or its designee accepts in writing. Said acceptance is the sole condition upon which the effectiveness of such assignments are contingent. County or its designee may accept any such assignment at any time during the course of the Work and prior to Final Completion. Such contingent assignments are part of the consideration to County for entering into the Construction Contract with Contractor and may not be withdrawn prior to Final Completion.

**5.3.3 County Obligation.** County's or its designee's sole obligation in the event it accepts a contingent assignment of a subcontract under this Section 5.3 shall be to pay in accordance with the terms of such subcontract for Work performed after written notice of acceptance of such assignment. In the event County directs that such assignment be made to County's designee, then such designee only, and not County, shall be solely liable under such assignment for Work performed after written notice of acceptance of such assignment.

#### **5.4 COMMUNICATIONS BY COUNTY**

County shall have the right to communicate, orally or in writing, with the Subcontractors with respect to matters that are related to Contractor's performance of its obligations under the Contract Documents. Nothing herein shall be interpreted as extending to County the right as part of such communications to direct the manner in which any Subcontractor performs the Work. Except as otherwise provided in the Construction Contract, General Conditions, or Contract Documents, Contractor shall be provided with a copy of all such communications that are in writing. Such communications shall not create, or be interpreted as creating, any contractual obligation of County to any Subcontractor.

#### **5.5 DOCUMENT AVAILABILITY**

Contractor shall make available to each proposed Subcontractor with whom it enters into a contract for performance of any portion of the Work, prior to the execution of the subcontract agreement, copies of the Contract Documents to which the Subcontractor will be bound so as to ensure that all matters disclosed thereby are taken into consideration and included in the terms of such contracts and shall identify to such Subcontractor the terms and conditions of the proposed subcontract agreement which may be at variance with the Contract Documents. The Subcontractors shall similarly be required to make copies of applicable portions of such documents available to their respective proposed sub-subcontractors or sub-subconsultants.

#### **5.6 NO LIABILITY OF COUNTY**

Nothing set forth in this Article 5, and no action taken by County with respect to review or approval of the Subcontractors or their contracts, shall impose any liability or responsibility upon County nor relieve Contractor of its responsibilities under the Contract Documents or Applicable Laws.

### **ARTICLE 6 COUNTY'S OWN FORCES AND SEPARATE CONTRACTORS**

#### **6.1 COUNTY'S RIGHT TO PERFORM CONSTRUCTION WITH OWN FORCES AND TO AWARD SEPARATE CONTRACTS**

**6.1.1 Right of County.** County reserves the right to perform construction or operations related to the Project with County's own forces and to award other contracts to Separate Contractors in connection with other portions of the Project or other construction or operations on the Site.

**6.1.2 Separate Contractors.** Contractor shall ascertain to its own satisfaction the scope of the Project and the nature of any other contracts that have been or may be awarded by County to Separate Contractors in

prosecution of the Project. Contractor shall look solely to such Separate Contractors, and County shall not be responsible, for any Losses for which Contractor is not provided a right or recovery by means of a right to Contract Adjustment for Compensable Change or Compensable Delay, that are suffered by Contractor or the Subcontractors, of any Tier, resulting directly or indirectly from the conduct of such work by the Separate Contractors.

**6.1.3 Coordination.** Nothing in the Contract Documents creates or will create any duty on the part of County to coordinate the Work of Contractor with the work of Separate Contractors. Contractor shall, when directed to do so by County, participate with the Separate Contractors and County in reviewing the Separate Contractors' construction schedules. Contractor and Separate Contractors will coordinate all work with the other so as to facilitate the general progress of the Project. Contractor agrees that any recovery of Losses for which Contractor is not provided a right or recovery by means of a right to Contract Adjustment for Compensable Change or Compensable Delay, that are suffered by Contractor due to a failure by a Separate Contractor to coordinate its work with the Work of Contractor will be sought directly against the Separate Contractors as set forth elsewhere in this Article 6.

**6.1.4 Disputes.** Contractor and County agree that Separate Contractors in direct contractual privity with County are third party beneficiaries of the Contract Documents, but only to the extent of claims and causes of action against Contractor arising out of or resulting from Contractor's performance or failure of performance under the Contract Documents or any act or omission of Contractor or the Subcontractors causing Loss to such Separate Contractors. Contractor consents to being sued by Separate Contractors for Losses caused by Contractor or any of the Subcontractors. Contractor hereby waives lack of privity of contract with such Separate Contractors as a defense to such actions.

**6.1.5 Remedy.** If Contractor as a result of the acts or omissions of one or more of the Separate Contractors suffers a Loss that is not compensated by means of a right given to Contractor under the Contract Documents to a Contract Adjustment, then Contractor's sole remedy is to assert a claim or cause of action directly against the Separate Contractor(s) causing the Loss and Contractor hereby releases, acquits, holds harmless and forever discharges County of and from any and all liability for such Loss.

## **6.2 MUTUAL RESPONSIBILITY**

**6.2.1 Use of Site.** Nothing contained in the Contract Documents shall be interpreted as granting Contractor exclusive use or occupancy of the Site. Contractor shall afford County's own forces and the Separate Contractors reasonable opportunity for introduction and storage of their materials and equipment and performance of their activities. Contractor shall not Delay the work of the Separate Contractors or County's own forces.

**6.2.2 Adjoining Work.** If part of Contractor's performance of the Work depends for proper execution or results upon construction or operations by County's own forces or Separate Contractors, Contractor shall, prior to proceeding with that portion of the Work, carefully inspect such construction and operations and promptly report in writing to the County apparent discrepancies or defects in such other construction that would render it unsuitable for such proper execution and results. Contractor will be responsible, at Contractor's Own Expense, for Losses to County resulting from any such discrepancies or defects not reported in accordance with this Paragraph 6.2.1 that were apparent or that should have been apparent to Contractor on careful inspection.

**6.2.3 Damage.** Contractor shall promptly remedy Loss caused by Contractor or its Subcontractors to completed construction or partially completed construction on the Site, or to property of County or the Separate Contractors.

**6.2.4 Disputes.** Contractor shall notify the County in writing within five (5) Days if it believes it has experienced or is experiencing any Delay or Loss due to the activities of County's own forces or the Separate Contractors or in the event of any dispute with County's own forces or a Separate Contractor.

**6.2.5 Settlement of Disputes.** If Contractor or any Subcontractor causes a Loss to a Separate Contractor, then Contractor will promptly settle the matter directly with the Separate Contractor and will defend, indemnify and hold County and the other Indemnitees harmless from any and all effects of such Loss in accordance with the terms of Section 3.18, above.

### 6.3 ALLOCATION OF CLEANUP COSTS

If a dispute arises among Contractor, the Separate Contractors and/or County as to the responsibility for maintaining the Site and surrounding area free from waste materials and rubbish, County may clean up such waste materials and rubbish and allocate the cost among those responsible as County determines in good faith to be just.

## ARTICLE 7 CHANGES IN THE WORK

### 7.1 CHANGES

**7.1.1 General.** County is authorized to make Changes in the Work in accordance with the provisions of this Article 7. Contract Adjustments shall take one of the following forms under this EZIQC Contract: **.1**

A Change Order may be issued to the EZIQC Contract to extend the duration of the EZIQC Contract and/or to increase the value of the EZIQC Contract in accordance with applicable regulations, laws and Public Contract Code, to address deleted work or compensable changes. .

**.2** A Supplemental Work Order may be issued in association with an existing approved Work Order, under this EZIQC Contract, to address deleted work or compensable changes.

**7.1.2 Contract Adjustments.** ~~Contract~~ Adjustments to the Work Order Contract shall only be permitted as follows: (1) the Contract Price shall only be adjusted by means of a Change Order or Unilateral Change Order for Compensable Change, Deleted Work or Compensable Delay; and (2) the Work Order Contract Time shall be adjusted by means of a Change Order or Unilateral Change Order for Excusable Delay, Compensable Delay or Deleted Work. All Contract Adjustments to the Contract Price shall conform, without limitation, to the requirements of this Article 7. All Contract Adjustments to the Contract Time shall conform, without limitation, to the applicable requirements of this Article 7 and Article 8, below.

**7.1.3 Work Order Adjustments.** Adjustments to projects for which a Work Order has been issued under the NJPA Contract shall only be permitted as follows: (1) a Supplemental Work Order shall be issued to offset the original Work Order amount by adding or deleting scope and the agreed price in accordance with the contract. A Supplemental Work Order will adjust the project cost by providing the primary back-up documentation to an approved County Change Order or Unilateral County Change Order for Compensable Change, Deleted Work or Compensable Delay; and (2) A Supplemental Work Order may also be used to offset the Work Order Time by adding or deleting days by providing primary back-up documentation to an approved County Change Order or Unilateral Change Order for Excusable Delay, Compensable Delay or Deleted Work. All Work Order Adjustments shall conform to the requirements of each project for which NJPA-EZIQC Contracting program is being used and to the Contract Documents, without limitation, as well as to the requirements of this Article 7. All Work Order Adjustments to Time shall conform, without limitation, to the applicable requirements of this Article 7 and Article 8, below.

**7.1.4 Exclusive Rights.** The rights expressly set forth in the Contract Documents for Contract Adjustments constitute Contractor's exclusive rights for additional compensation or extensions of time and are intended to be in lieu of and wholly replace any other such rights and remedies that Contractor has under Applicable Laws for recovery or relief on account of Loss or Delay in connection with performance of the Work, it being the intent of the County and Contractor that if circumstances arise for which the Contract Documents do not provide to Contractor an express right to a Contract Adjustment, then such omission of an express right shall conclusively be deemed to mean that no right to a Contract Adjustment was intended; and, consistent with that intent, no right to a Contract Adjustment on account of such circumstances shall by any means, legal or equitable, of interpretation, construction, inference, implication or application be considered, found or adjudged to exist.

**7.1.5 Written Authorization.** Any Change performed by Contractor pursuant to any direction other than a duly authorized and executed Supplemental Work Order, Change Order, Unilateral Change Order or Construction Change Directive shall be at Contractor's Own Expense.

**7.1.6 Prompt Performance.** Subject to the procedures set forth in this Article 7 and elsewhere in the Contract Documents, all Changes shall be performed promptly and without Delay.

## 7.2 SIGNATURES AND AUTHORIZATIONS

7.2.1 **Parties.** A Supplemental Work Order, as back-up to all Change Orders, and a County Change Order shall be executed by County and Contractor. A Unilateral Change Order shall be executed by the County. Construction Change Directives shall be executed in accordance with Section 7.5, below.

7.2.2 **Form.** Supplemental Work Orders, Change Orders, Unilateral Change Orders and Construction Change Directives shall be executed using forms furnished by County or, if requested by County, using forms furnished by Contractor that are approved by County.

### 7.2.3 Authorization.

#### .1 Compensable Changes.

(1) **Assistant CEO/EDA.** A Compensable Change shall be performed by Contractor only if authorized by a Supplemental Work Order, Change Order, Unilateral Change Order or Construction Change Directive signed by the Assistant CEO/EDA in accordance with the requirements of this Article 7; provided, however, that Assistant CEO/EDA's authority to bind the County to a Contract Adjustment shall be subject to the limitations of Public Contract Code §20142.

(2) **County's Project Manager.** The person identified by County as its "project manager" for the Project shall have the right to exercise the Assistant CEO/EDA's authority under this Paragraph 7.2.3, but only if and to the extent that such authority is expressly given to such project manager in a writing signed by the Assistant CEO/EDA (and not by a designee of the Assistant CEO/EDA).

(3) **Board of Supervisors.** Except as otherwise provided in Subparagraph 7.2.3.1 (4), below, if a Contract Adjustment increasing the Contract Price would exceed the limitations of Public Contract Code §20142, then in addition to written authorization by the Assistant CEO/EDA, such Compensable Change shall be performed only if approved by a vote of the Board of Supervisors in accordance with the requirements of Applicable Laws.

(4) **Disputed Changes.** If a dispute arises between County and Contractor over (a) whether a particular portion of the Work constitutes a Compensable Change or (b) the amount of the Contract Adjustment to which Contractor is entitled on account of a Compensable Change, then, notwithstanding such dispute, the Contractor shall, if ordered to do so in a Construction Change Directive signed by Assistant CEO/EDA, perform the disputed Work without Delay. Such direction by County shall not be interpreted as an agreement or admission by County that the disputed Change constitutes Extra Work or a Compensable Change for which Contractor is entitled to a Contract Adjustment. Compliance by Contractor with such direction shall not be interpreted as a waiver of Contractor's right to a Contract Adjustment if and to the extent that Contractor is entitled to a Contract Adjustment or Claim under the terms of the Contract Documents, including, without limitation, the right of Contractor to recover upon a Claim for the amount of any excess in the event that it is adjudged that the amount of the Contract Adjustment to which Contractor is entitled exceeds the limits of Public Contract Code §20142.

**.2 WRITING OF ESSENCE. IT IS OF THE ESSENCE TO THE CONSTRUCTION CONTRACT BETWEEN CONTRACTOR AND COUNTY THAT ALL CHANGES MUST BE AUTHORIZED IN ADVANCE, IN WRITING, AS REQUIRED BY THIS ARTICLE 7. ACCORDINGLY, NO VERBAL DIRECTIONS, COURSE OF CONDUCT BETWEEN THE PARTIES, EXPRESS OR IMPLIED ACCEPTANCE OF CHANGES OR OF THE WORK, OR CLAIM THAT THE COUNTY HAS BEEN UNJUSTLY ENRICHED (WHETHER OR NOT THERE HAS BEEN SUCH ENRICHMENT) SHALL BE THE BASIS FOR A CONTRACT ADJUSTMENT IF CONTRACTOR HAS NOT OBTAINED ADVANCE WRITTEN AUTHORIZATION IN THE MANNER REQUIRED BY THIS ARTICLE 7.**

## 7.3 CHANGE ORDERS

7.3.1 **Purpose.** The purpose of a Change Order is to establish the terms of the County's and Contractor's mutual agreement to a Contract Adjustment. Contract Adjustments shall take one of the following forms under this EZIQC-Work Order Contract:

.1 A County **Change Order (Change Order)** may be issued to the EZIQC Contract to extend the duration of the agreement and/or to increase the Maximum Potential Value in accordance with applicable regulation, laws and public contract code. The Change Order shall minimally include reference to the associated Supplemental Work Order, which shall be kept on file as primary back-up documentation to the Change Order.

**Content.** A Supplemental Work Order is a written instrument, prepared by the Contractor, using the e-Gordian software associated with the NJPA-EZIQC Program, stating:

- .1 a Compensable Change or Deleted Scope of Work;
- .2 a Compensable Delay or Excusable Delay;
- .3 the amount of the Work Order Adjustment, if any, to the Work Order Price; and/or
- .4 the extent of the Work Order Adjustment, if any, to the Work Order Time.

#### 7.4 UNILATERAL SUPPLEMENTAL WORK ORDER

7.4.1 **Unilateral Supplemental Work Order.** A Unilateral Supplemental Work Order shall be the primary back-up documentation to a Unilateral Change Order issued by the County. The purpose of the Unilateral Supplemental Work Order is to provide the County with a flexible procedure by which it may respond expeditiously to its needs. By virtue of this clause, the County is entitled to order Work and to bind the Contractor to performance of the Work as needed for the term of this EZIQC Contract.

7.4.2 **Purpose.** The purpose of a Unilateral Supplemental Work Order is to establish the County's estimate of a disputed Contract Adjustment.

7.4.3 **Good Faith Determination.** The County's determination in a Unilateral Supplemental Work Order of a Contract Adjustment shall be based upon a Good Faith Determination by County of the Contract Adjustment that is appropriate under the circumstances and consistent with the terms of the Contract Documents.

7.4.4 **Claim by Contractor.** If Contractor disputes any portion of the County's Good Faith Determination of a Contract Adjustment that is set forth in a Unilateral Supplemental Work Order, Contractor shall file, within thirty (30) Days after issuance of the Unilateral Supplemental Work Order by County, a Claim pursuant to Section 4.3, above. The amount of the Contract Adjustment requested in the Claim shall not exceed the difference between the amount (either in terms of dollar amount or number of Days) of the Contract Adjustment requested by Contractor and the amount (either in terms of dollar amount or number of Days) of the Contract Adjustment granted in the Unilateral Supplemental Work Order. Contractor shall have no reserved right, and hereby waives any such right that may exist under Applicable Laws, to seek in such Claim a Contract Adjustment or recovery that is based upon any amount (either in terms of dollar amount or number of Days) that is in excess of such difference.

#### 7.4.5 WAIVER BY CONTRACTOR.

**FAILURE BY CONTRACTOR TO SUBMIT A CLAIM PURSUANT TO SECTION 4.3, ABOVE, WITHIN THIRTY (30) DAYS AFTER ISSUANCE OF A UNILATERAL SUPPLEMENTAL WORK ORDER BY COUNTY SHALL, IN ACCORDANCE WITH THE PROVISIONS OF SECTION 4.6 OF THE GENERAL CONDITIONS, CONSTITUTE A WAIVER BY CONTRACTOR OF THE RIGHT TO FURTHER RECOURSE OR RECOVERY BASED ON AN ASSERTION THAT THE AMOUNT OF THE CONTRACT ADJUSTMENT ON ACCOUNT OF THE CHANGE OR DELAY DESCRIBED IN SUCH UNILATERAL SUPPLEMENTAL WORK ORDER SHOULD BE DIFFERENT THAN THE AMOUNT OF THE COUNTY'S GOOD FAITH DETERMINATION OF THE CONTRACT ADJUSTMENT AS SET FORTH IN SUCH UNILATERAL SUPPLEMENTAL WORK ORDER.**

## 7.5 CONSTRUCTION CHANGE DIRECTIVES

7.5.1 **Purpose.** The purpose of a Construction Change Directive is to: (1) direct the performance of a Change that does not involve a Contract Adjustment; (2) establish a mutually agreed basis for compensation to Contractor for a Compensable Change under circumstances where performance of the Compensable Change needs to proceed in advance of the County performing a full evaluation of the Contractor's rights relative to a Contract Adjustment; or (3) direct performance of Work or a Change with respect to which there exists a dispute or question regarding the terms of a Contract Adjustment.

7.5.2 **No Contract Adjustment.** A Construction Change Directive that directs the performance of Work or a Change that does not involve a Contract Adjustment to the Contract Price or Contract Time may be authorized by either the Assistant CEO/EDA or the County's project manager and shall be promptly performed by Contractor so as to not cause Delay to any other portion of the Work. A Construction Change Directive directing performance of a Change that does not contain any statement indicating that a Contract Adjustment is requested or required shall be conclusively presumed to be a Change that is not a Compensable Change and no Contract Adjustment increasing the Contract Price or Contract Time will be made on account thereof.

7.5.3 **Agreed Contract Adjustment.** A Construction Change Directive that contains a complete or partial agreement by the County and Contractor with respect to the Contractor's right to, or the amount of, a Contract Adjustment shall be authorized in accordance with, conform to the requirements of and be binding upon County and Contractor as provided for in, this Paragraph 7.5.3.

**.1 Complete Agreement.** Each Construction Change Directive involving a Compensable Change or Deleted Work with respect to which there is complete agreement on the terms of the Contract Adjustment shall comply with the following:

(1) **Statement of Agreement.** A statement shall be included that the County and Contractor are in agreement on all of the terms of the Contract Adjustment related to performance of such Compensable Change and set forth a full description of the terms of the Contract Adjustment, including, without limitation, its effect on the Contract Price and Contract Time.

(2) **Legal Effect.**

(a) **Upon Contractor.**

**THE AGREED TERMS OF THE CONTRACT ADJUSTMENT WITH RESPECT TO WHICH THERE IS A STATEMENT OF FULL AGREEMENT ON THE TERMS OF THE CONTRACT ADJUSTMENT FOR A CHANGE IN THE WORK SHALL BE FINAL AND BINDING UPON CONTRACTOR. ANY RIGHT OR CLAIM BY CONTRACTOR FOR ANY ADDITIONAL COMPENSATION OR EXTENSION OF TIME RELATING DIRECTLY OR INDIRECTLY TO SUCH CHANGE SHALL BE CONCLUSIVELY DEEMED WAIVED BY CONTRACTOR, EVEN IF THE CIRCUMSTANCES GIVING RISE TO SUCH ADDITIONAL COMPENSATION OR EXTENSION OF TIME WERE NOT SUSPECTED BY OR KNOWN TO THE CONTRACTOR AT THE TIME OF EXECUTION OF THE CONSTRUCTION CHANGE DIRECTIVE AND IF SUSPECTED OR KNOWN WOULD HAVE BEEN CONSIDERED BY CONTRACTOR TO HAVE BEEN MATERIAL TO CONTRACTOR'S AGREEMENT TO THE CONTRACT ADJUSTMENT SET FORTH IN THE CONSTRUCTION CHANGE DIRECTIVE.**

(b) **Upon County.** In recognition of the fact that Construction Change Directives may be issued under circumstances in which the County may not have had the access to pertinent information required for the County to fully evaluate the circumstances giving rise to the Change, it is agreed that neither the issuance nor execution of, nor any statement contained in, nor any course of conduct in connection with, a Construction Change Directive (including, without limitation, a Construction Change Directive that constitutes a full agreement by County and Contractor on the terms of a Contract Adjustment) shall be interpreted as a waiver, release or settlement of any of County's rights relating to the subject matter of the Construction Change Directive, or as creating or implying any right of Contractor to a Contract Adjustment, if it is found by County upon further investigation that circumstances existed, not known to County at the time of executing the Construction Change Directive, demonstrating that the Contractor was not in fact entitled to a Contract Adjustment or was entitled to a Contract Adjustment on different terms than those agreed to in the Construction Change Directive.

**.2 Partial Agreement.** Each Construction Change Directive involving a Compensable Change or Deleted Scope of Work with respect to which there is only agreement on a portion of the terms of a Contract Adjustment shall comply with the following:

**(1) Agreed Terms.** The Construction Change Directive shall state those terms of the Contract Adjustment as to which there is agreement.

**(a) Legal Effect.** Except to the extent of any additional open (i.e., non-agreed) terms stated or reserved in the Construction Change Directive, such agreement shall have the same legal effect set forth in Subparagraph 7.5.3.1 (2), above.

**(b) Time and Materials.** In the event that County and Contractor agree in the Construction Change Directive to the “time and materials” method of calculation set forth in Subparagraph 7.7.1.1 (4), below, but do not agree upon a maximum price, then the total cost to County for the Work covered by the Construction Change Directive shall under no circumstances exceed a price that is reasonable, competitive and fair to County given the amount and type of Work involved and the circumstances under which the Compensable Change is performed.

**(2) Open Terms.** The Construction Change Directive shall state those terms of the Contract Adjustment that are “open” or “disputed”; meaning those terms as to which the County and Contractor did not reach agreement.

**(a) Legal Effect.** A Reasonable Order of Magnitude Estimate constitutes neither (i) a guarantee by Contractor that the amount of the Contract Adjustment to the Contract Price or Contract Time that may be associated with the Compensable Change or Deleted Work covered by such Construction Change Directive may not exceed the Reasonable Order of Magnitude Estimate nor (ii) authorization or agreement by County to a Contract Adjustment based on the amounts set forth in such Reasonable Order of Magnitude Estimate.

**(b) Time and Materials.** If County and Contractor state in the Construction Change Directive an agreement that the Contractor is entitled to a Contract Adjustment to the Contract Price on account of a Compensable Change, but do not state therein an agreement upon the method of calculation to be used for the Contract Adjustment from among the optional methods of calculation set forth in Paragraph 7.7.1, below, and if the County nonetheless directs Contractor to perform the Compensable Change pending future agreement on the amount of the Contract Adjustment, then it shall be conclusively presumed that County and Contractor have agreed that such Compensable Change shall be performed and compensated based upon the “time and materials” method of calculation set forth in Subparagraph 7.7.1.1 (4), below, and that the total Contract Adjustment for performance thereof shall under no circumstances exceed a price that is reasonable, competitive and fair to County given the amount and type of Work involved and the circumstances under which the Compensable Change is performed.

**7.5.4 Disputed Contract Adjustment.** Each Construction Change Directive involving a Contract Adjustment with respect to which there is a dispute or partial agreement shall, if Contractor is ordered to do so in a Construction Change Directive signed by the Assistant CEO/EDA, be performed by Contractor without Delay. Except as otherwise provided elsewhere in this Section 7.5, with respect to any open terms as to which the County and Contractor have not reached agreement both County and Contractor shall be deemed to have reserved their respective rights and defenses.

**7.5.5 Other Notices.** With respect to any Contract Adjustment or portion of a Contract Adjustment that is not fully resolved in a Construction Change Directive, neither issuance nor execution of such Construction Change Directive shall be interpreted as relieving Contractor of its obligation to comply with the requirements of these General Conditions relative to timely submission of notices required by the Contract Documents, including, without limitation, Notice of Change, Change Order Request, Notice of Delay or Request for Extension.

## **7.6 PROCEDURES**

### **7.6.1 Notice of Change.**

**.1 Submission.** Contractor shall submit a written Notice of Change to County if any instruction, request, drawing, specification, action, condition, omission, default or other circumstance occurs that constitutes a Compensable Change, Deleted Scope of Work, Compensable Delay or other matter that may involve or require a Contract Adjustment (additive or deductive). Such notice shall be provided prior to commencement of performance of the Work affected and no later than three (3) working days after the Discovery Date of such circumstance.

**.2 Form.** Notices of Change shall be provided using forms furnished by County or, if requested by County, using forms furnished by Contractor that are approved by County. Failure by County to request or approve a particular form shall not relieve Contractor of its obligation to provide a Notice of Change in a written form that complies with the requirements specified in Subparagraph 7.6.1.3, below.

**.3 Content.** Each Notice of Change in order to be considered complete shall include:

(1) a general statement of the circumstances giving rise to the Notice of Change (including, without limitation, identification of any related Construction Change Directive);

(2) if such circumstances involve a right to adjustment of the Contract Time due to Compensable Delay or Excusable Delay that has not been waived pursuant to Subparagraph 8.2.2.4, below, or Subparagraph 8.2.3.4, below, Contractor shall include, if not previously provided, a complete and timely Notice of Delay.

#### **.4 WAIVER BY CONTRACTOR.**

**FAILURE BY CONTRACTOR TO PROVIDE A COMPLETE AND TIMELY NOTICE OF CHANGE UNDER CIRCUMSTANCES WHERE A NOTICE OF CHANGE INVOLVING A CHANGE IS REQUIRED BY THIS PARAGRAPH 7.6.1 SHALL, IN ACCORDANCE WITH THE PROVISIONS OF SECTION 4.6 OF THE GENERAL CONDITIONS, CONSTITUTE A WAIVER BY CONTRACTOR OF THE RIGHT TO A CONTRACT ADJUSTMENT ON ACCOUNT OF SUCH CIRCUMSTANCES AND A WAIVER OF ANY RIGHT TO FURTHER RECOURSE OR RECOVERY BY REASON OF OR RELATED TO SUCH CHANGE.**

**.5 Deductive Adjustments.** Failure by Contractor to submit a timely or proper Notice of Change under circumstances in which a Notice of Change is required shall in no way affect County's right to any deductive Contract Adjustment on account of such circumstances.

#### **7.6.2 Change Order Request.**

**.1 Submission.** With respect to any matter that may involve or require a Contract Adjustment (additive or deductive) of the Contract Price, Contractor shall, within fourteen (14) Days after receipt by the County of a Notice of Change pursuant to Paragraph 7.6.1, above, submit to the County a written Change Order Request.

**.2 Form.** Change Order Requests shall be provided using forms furnished by County or, if requested by County, using forms furnished by Contractor that are approved by County. Failure by County to request or approve a particular form shall not relieve Contractor of its obligation to provide a Change Order Request in a written form that complies with the requirements stated in Subparagraph 7.6.2.3, below.

**.3 Content.** Each Change Order Request in order to be considered complete shall include:

(1) a detailed description of the circumstances for the Compensable Change, Deleted Work or Compensable Delay;

(2) a complete, itemized cost breakdown (additive and deductive) of the Allowable Costs that form the basis for the Contractor's request for Contract Adjustment, including: (a) if the pricing is based on time and materials charges, all of Contractor's and each Subcontractor's Allowable Costs (including, without limitation, quantities, hours, unit prices, and rates) and Allowable Markups and (b) if the pricing is in the form of a lump sum price a detailed breakdown of the lump sum price into its component and individual items of Allowable Costs and Allowable Markup; and



(3) if such circumstances involve a right to a Contract Adjustment of the Contract Time due to Compensable Delay or Excusable Delay that has not been waived pursuant to Subparagraph 8.2.2.4, below, or Subparagraph 8.2.3.4, below, Contractor shall include, if not previously provided, a complete and timely Request for Extension.

#### **.4 WAIVER BY CONTRACTOR.**

**FAILURE BY CONTRACTOR TO PROVIDE A COMPLETE AND TIMELY CHANGE ORDER REQUEST UNDER CIRCUMSTANCES WHERE A CHANGE ORDER REQUEST INVOLVING A CHANGE IS REQUIRED BY THIS PARAGRAPH 7.6.2 SHALL, IN ACCORDANCE WITH THE PROVISIONS OF SECTION 4.6 OF THE GENERAL CONDITIONS, CONSTITUTE A WAIVER BY CONTRACTOR OF THE RIGHT TO A CONTRACT ADJUSTMENT ON ACCOUNT OF SUCH CIRCUMSTANCES AND A WAIVER OF ANY RIGHT TO FURTHER RECOURSE OR RECOVERY BY REASON OF OR RELATED TO SUCH CHANGE.**

**.5 Deductive Adjustments.** Failure by Contractor to submit a timely or proper Change Order Request under circumstances in which a Change Order Request is required shall in no way affect County's right to any deductive Contract Adjustment on account of such circumstances.

**7.6.3 Formal Notice of Essence.** Contractor recognizes and acknowledges that timely submission of a formal Notice of Change and Change Order Request, whether or not the circumstances of the Change may be known to the County or available to County through other means, is not a mere formality but is of crucial importance to the ability of County to promptly identify, prioritize, evaluate and mitigate the potential effects of Changes. Any form of informal notice, whether verbal or written (including, without limitation, statements in Requests for Information, statements at regular job meetings or entries on monthly reports, daily logs or job meeting minutes), that does not strictly comply with the formal requirements of Paragraph 7.6.1, above, and Paragraph 7.6.2, above, shall therefore be insufficient.

#### **7.7 PRICING**

##### **7.7.1 Basis of Calculation.**

**.1 Changes Not Involving Time.** Contract Adjustments to the Contract Price on account of Compensable Changes or Deleted Work, other than Contract Adjustments to the Contract Price for Compensable Delay, shall be calculated according to one of the following methods:

(1) **Lump Sum.** By mutual acceptance of a lump sum proposal from Contractor based solely on Allowable Costs and Allowable Markups, that is properly itemized and supported by sufficient substantiating data to permit evaluation.

(2) **Unit Prices.** By the unit prices set forth in the CTC or such other unit prices as are subsequently and mutually agreed to in writing between the County and Contractor, with no amount added thereto for Allowable Markups.

(3) **Estimating Guides.** For Compensable Changes with respect to which County elects to make a unilateral and final determination pursuant to Paragraph 7.7.11, below, by the sum of all the following:

(a) **Materials.** The reasonable value of materials and equipment documented as having been actually incorporated into the Work, which reasonable value may be less but shall never be more than Contractor's actual Allowable Costs therefor.

(b) **Labor.** An estimate of the reasonable costs of labor, installation and other services using the Construction Task Catalogs (CTC) as reported in the (i) The Gordian Group Company, Inc. Building Construction Cost Data, Riverside County – Latest Edition, 140 Bridges Road, Suite E, South Carolina, 29662, 800.874.2291.

(c) **Allowable Markup.** The amount that results when the applicable Allowable Markup is applied to the sum of the amounts derived from preceding Clauses (a) and (b) of this Subparagraph 7.7.1.1 (3).

(4) **Time and Materials.**

(a) **Compensable Changes.**

(i) **Contract Adjustment.** With respect to Compensable Changes, if none of the methods provided for in Subparagraphs 7.7.1.1 (1) through 7.7.1.1 (3), above, is applicable, then the additive amount increasing the Contract Price shall be calculated by taking (A) the total of the reasonable expenditures by Contractor and its Subcontractors, documented in the manner required by Paragraph 7.7.2, below, for Allowable Costs that are actually and directly incurred and paid in the performance of the Compensable Change, not to exceed for any Compensable Change a price that is reasonable, competitive and fair to County given the amount and type of Work involved and the circumstances under which the Compensable Change is performed, and (B) adding thereto the amount which results when the applicable Allowable Markups are applied to such total specified in preceding Clause (A) of this Subparagraph 7.7.1.1 (4) (a) (1).

(ii) **T & M/Guaranteed Maximums.** A Contract Adjustment that is calculated pursuant to this Subparagraph 7.7.1.1 (4) shall be subject to a not-to-exceed or guaranteed maximum price if such not-to-exceed or guaranteed maximum price has been mutually agreed upon between County and Contractor.

(b) **Deleted Work.** With respect to Deleted Work (whether or not the Deleted Work involves a related Compensable Change as described in Paragraph 7.7.8, below), if none of the methods provided for in Subparagraphs 7.7.1.1 (1) through 7.7.1.1 (3), above, is applicable, then, in addition to the reduction, if any, that may be due to Owner pursuant to Subparagraph 8.2.6.2, below, (pertaining to Contract Adjustments shortening the Contract Time due to Deleted Work) and any additional reductions or credits to which County may be entitled under Paragraph 7.7.5, below, the Contract Price shall be reduced by the greater of either:

(i) the value assigned to the Deleted Work in the Schedule of Values attached to the Construction Contract, inclusive of all estimated markups by Contractor and any Subcontractor for overhead and profit set forth in the Schedule of Values (or, if insufficient detailed information on costs, overhead and profit for the Deleted Work is explicitly assigned in the Schedule of Values, as derived from the cost, bidding and/or estimating information that formed the basis for the establishment of the values set forth in such Schedule of Values);  
or

(ii) a reasonable estimate of the value of the Deleted Work (inclusive of all costs, overhead and profit) as of the date that the Construction Contract was executed by County and Contractor.

**.2 Changes Involving Time.** Contract Adjustments that are based on an extension of the Contract Time for Compensable Delay or a shortening of the Contract Time due to Deleted Work shall be calculated in the manner stated in the provisions of Section 3.3 of the Construction Contract and Article 8, below. Contract Adjustments that are based on an acceleration in performance of the Work that is ordered by County in writing to overcome a Compensable Delay for which the Contractor is entitled to an extension of the Contract Time that has been properly requested and is not granted by County due to a County decision to accelerate rather than extend the Contract Time shall be calculated in the manner stated in the provisions of Article 8, below.

**7.7.2 Time and Materials Documentation.** Without limitation to any other provisions of the Contract Documents, Contractor's right to reimbursement of Allowable Costs incurred by Contractor or Subcontractors in the performance of a Compensable Change for which the Contract Adjustment is calculated pursuant to the time and materials method set forth in Subparagraph 7.7.1.1 (4), above, shall be conditioned on Contractor's compliance with the following conditions with respect to documentation of the Extra Work that is involved in the performance of the Compensable Change:

**.1 Labor.** At the close of each Day on which such Extra Work is performed, Contractor shall submit to County and, if requested, to the Inspector of Record, an Extra Work report, on forms provided by County, that sets forth with respect to each and all of the actual hours spent in performance of the Extra Work on the Day that the Extra

Work was performed the following: the names of the workers, their classifications, hours worked and hourly rates. Such forms shall include a written certification by Contractor's project manager or superintendent at the time of submission that the information contained therein is complete and accurate.

**.2 Materials, Equipment.** At the close of each Day on which such Extra Work is performed, Contractor shall submit to County and, if requested, to the Inspector of Record, an Extra Work report, on forms provided by County, that sets forth with respect to each and all of the materials and equipment used or consumed in the performance of the Extra Work on the Day that the Extra Work was performed, the following: a list of the materials and equipment, prices or rates charged, in the case of equipment a description of the type of equipment, identification number, and hours of operation (including loading and transportation), and copies of delivery tickets, invoices or other documentation confirmatory of the foregoing.

**.3 Other Expenditures.** At the close of each Day on which such Extra Work is performed, Contractor shall submit to County and, if requested, to the Inspector of Record, an Extra Work report, on forms provided by County, that sets forth a list of other expenditures constituting Allowable Costs incurred in performance of the Extra Work on the Day that the Extra Work was performed, along with documentation verifying the amounts thereof in such detail as County may require.

**.4 Subsequent Documentation.** Documentation not available on any Day that a portion of the Extra Work is performed shall be submitted as soon as they are available but not later than twenty-one (21) Days after the earlier of the Day of delivery or incorporation of the particular item of Extra Work at the Site.

**.5 Subcontractor Costs.** Extra Work performed by Subcontractors on a time and materials basis shall documented in the same manner as required of Contractor under this Paragraph 7.7.2. If Owner approves of a lump sum price for a Subcontractor's performance of Extra Work, then Contractor shall submit in lieu of the documentation otherwise required by this Subparagraph 7.7.2.5, such documentation as may be requested by Owner confirming the Extra Work performed on any given Day.

**.6 Authentication.** In addition to the foregoing, County may require that Contractor comply with other reasonable requirements pertaining to observation and verification of time and materials work and authentication of time and materials tickets and invoices by persons designated by County for such purpose.

#### **.7 WAIVER BY CONTRACTOR.**

**THE FAILURE OF CONTRACTOR TO SUBMIT AUTHENTICATION OF COSTS IN THE MANNER REQUIRED BY THIS PARAGRAPH 7.7.2 SHALL, IF COUNTY ELECTS IN ITS REASONABLE DISCRETION TO TREAT IT AS SUCH, CONSTITUTE A WAIVER BY CONTRACTOR OF ANY RIGHT TO A CONTRACT ADJUSTMENT FOR THE ALLOWABLE COSTS INCURRED FOR PERFORMANCE OF THAT PORTION OF THE EXTRA WORK FOR WHICH CONTRACTOR HAS FAILED TO PROVIDE SUCH AUTHENTICATION.**

**7.7.3 Allowable Costs.** The term "Allowable Costs" (1) means the costs that are listed in this Paragraph 7.7.3 and (2) excludes costs that do not constitute Allowable Costs under Paragraph 7.7.4, below:

**.1 Labor.** Straight-time wages and, if specifically authorized by County in writing, overtime wages for employees employed at the Site, including wages for employees of Subcontractors performing engineering or fabrication detailing at locations other than at the Site. The use of a labor classification which would increase the Allowable Costs for Extra Work will not be permitted unless Contractor establishes the necessity for the use of such labor classification. Overtime wages and salaries shall only constitute an Allowable Cost to the extent permitted by the Contract Documents and only as specifically authorized by County in writing setting forth the amount of overtime anticipated, which amount shall be deemed the maximum amount of overtime reimbursable as an Allowable Cost. As part of the Allowable Costs permitted by this Subparagraph 7.7.3.1, Contractor shall be entitled to be reimbursed wages paid to a "time and materials clerk" employed by Contractor to track and document Compensable Changes that are authorized or permitted to be performed on a time and materials basis pursuant to Subparagraph 7.7.1.1 (4), above, provided that the time expended by such employee is verified by contemporaneously maintained time sheets maintained by such clerk showing the actual time spent tracking and documenting the performance of Compensable Changes separately from other tasks or functions performed by such clerk.

**.2 Benefits.** To the extent based on wages reimbursable under Subparagraph 7.7.3.1, above, net actual employer costs of payroll taxes (FICA, Medicare, SUTA, FUTA), insurance (as adjusted for experience modifiers, premium discounts, dividends, rebates, expense constants, assigned risk pool costs, net cost reductions due to policies with deductibles for self-insured losses, assigned risk rebates, or the like), health and welfare, pension, vacation, apprenticeship funds and benefits required by lawful collective bargaining agreements.

**.3 Materials.** Costs of materials used or consumed in the Work. Such costs for Extra Work shall be at a price that is competitive to the price charged for similar materials delivered within the general vicinity of the Site by other subcontractors, suppliers, manufacturers and distributors. The cost for any such item that is not new shall mean "fair market value" based on the estimated price a reasonable purchaser would pay to purchase the used material at the time it was used or consumed for the Work, which fair market value must be declared by Contractor and approved by County prior to such use or consumption.

**.4 Taxes.** Sales taxes on the costs of the materials described in Subparagraph 7.7.3.3, above.

**.5 Equipment Rental.** Rental charges for necessary machinery and equipment, exclusive of hand tools, whether rented from Contractor or others. No charge shall be allowed or credit required for items which have a replacement value of One Hundred Dollars (\$100) or less. The allowable rental rates shall include the cost of fuel, oil, lubrication, supplies, small tools, necessary attachments, loading, transportation, repairs and maintenance of any kind, depreciation, storage, insurance and all incidentals. If equipment used for Extra Work is used intermittently and, when not in use, could be returned to its rental source at less expense to County than holding it at the Site, it shall be returned, unless Contractor elects to keep it at the Site at no expense to County. Under no circumstances shall the aggregate rentals chargeable for any item of equipment exceed the following percentages of the fair market value of the item at the time of its first use for the Work, which fair market value must be declared by Contractor and approved by County prior to the first use of such item in or for the Work: (1) if the item is owned by the Contractor or any company affiliated with Contractor, the aggregate rentals shall not exceed 75% of such fair market value; and (2) if the item is not owned by the Contractor or any company affiliated with Contractor, the aggregate rentals shall not exceed 100% of such fair market value. All equipment shall be acceptable to County, in good working condition, and suitable for the purpose for which it is to be used. Manufacturer's ratings and manufacturer's approved modifications shall be used to classify equipment, and it shall be powered by a unit of at least the minimum rating recommended by the manufacturer. The cost of major repairs or overhauls of rented equipment or machinery shall be deemed a cost of business of the lessor of such equipment or machinery and shall not be reimbursable as an Allowable Cost.

**.6 Subcontractors.** Payments made by Contractor to Subcontractors; provided, however, that: (1) such payments are not otherwise precluded from reimbursement by the terms of the Contract Documents; (2) such payments are for Work performed in accordance with the requirements of the Contract Documents; (3) such payments are for amounts properly due and owing by Contractor under the terms of the governing contract between Contractor and such Subcontractor; and (4) in the case of payments for extra work performed by a Subcontractor pursuant to a change order executed between Contractor and a Subcontractor the change order was executed under circumstances in which the Subcontractor was entitled under the terms of its contract with Contractor to receive the amount of additional compensation agreed to in the change order.

**.7 Royalties, Permits.** Costs of royalties and permits.

**.8 Bonds.** Costs of bonds required to be furnished by Contractor (not Subcontractors) under the terms of the Contract Documents; provided, however, that such additional costs chargeable for Extra Work or credited for Deleted Work shall not exceed two percent (2%) of the costs described in Subparagraphs 7.7.3.1 through 7.7.3.7, above.

**7.7.4 Costs Not Allowed.** Allowable Costs shall not include any of the costs associated with any of the following (whether incurred by Contractor or a Subcontractor):

- .1 superintendent(s);
- .2 assistant superintendent(s);
- .3 project engineer(s);

- .4 project manager(s);
- .5 scheduler(s);
- .6 estimator(s);
- .7 drafting or detailing (except as otherwise permitted by Paragraph 7.7.3.1, above)
- .8 vehicles not dedicated solely to the performance of the Work;
- .9 small tools with a replacement value not exceeding One Hundred Dollars (\$100);
- .10 office expenses, including staff, materials and supplies;
- .11 on-Site and off-Site trailer and storage rental and expenses;
- .12 Site fencing not added solely due to the performance of Extra Work;
- .13 utilities, including gas, electric, sewer, water, telephone, telefax and copier equipment;
- .14 computer and data-processing personnel, equipment and software;
- .15 federal, state or local business, income and franchise taxes;
- .16 insurance (including, without limitation, general liability, automobile and worker's compensation);
- .17 without limitation to Contractor's right to liquidated damages under Section 3.3 of the Construction Contract, Losses, of any kind, incurred by Contractor or a Subcontractor, of any Tier, that arise from or relate to Delay (including Excusable Delay, Compensable Delay or Unexcused Delay) or acceleration to overcome the effects of such Delay; and
- .18 costs and expenses of any kind or item not specifically and expressly included in Paragraph 7.7.3, above.

**7.7.5 Allowable Markups.** Allowable Markups consist of the percentages set forth provided for by this Paragraph 7.7.5. Allowable Markups are deemed to cover, without limitation, the following: (1) direct and indirect overhead (including, without limitation, consumables, small tools and cleanup) and profit of the Contractor; (2) direct and indirect overhead (including, without limitation, consumables, small tools and cleanup) and profit of the Subcontractors, of every Tier; and (3) all costs that are not reimbursable to Contractor under Paragraph 7.7.4, above. Subject to the exclusions and limitations set forth in Paragraph 7.7.7, below, or elsewhere in the Contract Documents, Allowable Markups include and are limited to the following:

**.1 Self-Performed Work**

**(1) Compensable Change.** With respect to all or that portion of a Compensable Change involving Self-Performed Work, the Allowable Markup to Contractor shall be not more than five percent (5%), which percentage shall for purposes of calculating the Contract Adjustment be multiplied times the Allowable Costs incurred by Contractor in the performance thereof, including, without limitation, Allowable Costs for materials or equipment purchased by Contractor from a first-Tier Subcontractor that is not an Installation Subcontractor.

**(2) Deleted Work.** With respect to all or that portion of Deleted Work involving Self-Performed Work, County shall be entitled to a credit equal to five percent (5%) of the amount of the credit for the savings to Contractor for the Self-Performed Work as calculated pursuant to Subparagraph 7.7.1.1 (4), (b), above.

**.2 Installation Subcontractors (First-Tier)**

**(1) Compensable Change.** With respect to all or that portion of a Compensable Change that is performed by a first-Tier Installation Subcontractor, the Allowable Markups to the first-Tier Installation Subcontractor and the Contractor shall be as follows:

**(a)** The Allowable Markup to the first-Tier Installation Subcontractor shall be not more than fifteen percent (15%), which percentage shall for purposes of calculating the Contract Adjustment be multiplied times the Allowable Costs incurred by such first-Tier Installation Subcontractor in the performance of such Compensable Change.

**(b)** The Allowable Markup to Contractor shall be five percent (5%), which percentage shall for purposes of calculating the Contract Adjustment be multiplied times the sum of (i) the Allowable Costs incurred by such first-Tier Subcontractor in the performance of such Compensable Change and (ii) the amount which results when the Allowable Markups thereon that are permitted pursuant to preceding Clause (a) of this Subparagraph 7.7.5.2 (1) are multiplied times such Allowable Costs.

**(2) Deleted Work.** With respect to all or that portion of Deleted Work that was to have been performed by a first-Tier Installation Subcontractor, the Contract Price shall be reduced as provided in Subparagraph 7.7.1.1 (4), (b), above. In addition, a credit shall be due from Contractor of five percent (5%) of the amount of the total credit due pursuant to Subparagraph 7.7.1.1 (4), (b), above.

### **.3 Installation Subcontractors (Second-Tier)**

**(1) Compensable Change.** With respect to all or that portion of a Compensable Change that is performed by a second-Tier Installation Subcontractor, the Allowable Markups to such second-Tier Installation Subcontractor, to the first-Tier Installation Subcontractor that is above and in the same vertical contractual line of Tiers with such second-Tier Installation Subcontractor and to the Contractor, shall be as follows:

**(a)** The Allowable Markup to the second-Tier Installation Subcontractor shall be not more than five percent (5%), which percentage shall for purposes of calculating the Contract Adjustment be multiplied times the Allowable Costs incurred by such second-Tier Installation Subcontractor in the performance of such Compensable Change.

**(b)** The Allowable Markup to the first-Tier Installation Subcontractor that is above and in the same vertical contractual line of Tiers with such second-Tier Installation Subcontractor shall be not more than fifteen percent (15%), which percentage shall for purposes of calculating the Contract Adjustment be multiplied times the sum of (i) the Allowable Costs incurred by such second-Tier Installation Subcontractor in the performance of such Compensable Change and (ii) the amount which results when the Allowable Markups thereon pursuant to preceding Clause (a) of this Subparagraph 7.7.5.3 (1) are multiplied times such Allowable Costs.

**(c)** The Allowable Markup to Contractor shall be five percent (5%), which percentage shall for purposes of calculating the Contract Adjustment be multiplied times the sum of (i) the Allowable Costs incurred by the second-Tier Installation Subcontractor in the performance of such Compensable Change and (ii) the amounts which result when the Allowable Markups thereon that are permitted pursuant to Clauses (a) and (b) of this Subparagraph 7.7.5.3 (1) are multiplied times such Allowable Costs.

**(2) Deleted Work.** With respect to all or that portion of Deleted Work that was to have been performed by a second-Tier Installation Subcontractor, the Contract Price shall be reduced as provided in Subparagraph 7.7.1.1 (4), (b), above. In addition, a credit shall be due from Contractor of five percent (5%) of the amount of the total credit due pursuant to Subparagraph 7.7.1.1 (4), (b), above.

### **.4 Other Subcontractors.**

**(1) Compensable Changes:** With respect to any other Subcontractor, of any Tier, performing all or a portion of a Compensable Change who is not an Installation Subcontractor or who is an Installation Subcontractor below the second-Tier, the following shall apply:

**(a)** No markup shall be allowed to such other Subcontractor.

(b) The Subcontractor that is positioned in the Tier immediately above such other Subcontractor shall be entitled to an Allowable Markup of not more than five percent (5%) upon the Allowable Costs incurred by such other Subcontractor in the performance thereof.

(c) No other Allowable Markup by any Subcontractor of any Tier above such other Subcontractor shall be permitted.

(d) Contractor shall be entitled to an Allowable Markup of five percent (5%) of the sum of (i) the Allowable Costs of such other Subcontractor incurred in the performance of such Compensable Change and (ii) the amount which results when the Allowable Markup permitted by Clause (b) of this Subparagraph 7.7.5.4 (1) is multiplied times such Allowable Costs.

(2) **Deleted Work.** With respect to all or that portion of Deleted Work that was to have been performed by such other Subcontractor who is not an Installation Subcontractor or who is an Installation Subcontractor below the second-Tier, the Contract Price shall be reduced as provided in Subparagraph 7.7.1.1 (4), (b), above. In addition, a credit shall be due from Contractor of five percent (5%) of the amount of the total credit due pursuant to Subparagraph 7.7.1.1 (4), (b), above.

7.7.6 **Review of Markups.** It is Contractor's responsibility to review information submitted by Subcontractors to ensure that all markups comply with the requirements of the Contract Documents. Payment by the County of markups that exceed Allowable Markups shall not be considered as a waiver by County of the right to require repayment by Contractor of any markup charged that is in excess of Allowable Markups and such excess amounts shall be promptly paid by Contractor to County.

7.7.7 **Exclusions and Limitations.** Allowable Markups are not permitted:

- .1 on agreed unit prices;
- .2 on materials, products or equipment furnished by County;
- .3 on liquidated damages payable to Contractor pursuant to Section 3.3 of the Construction Contract for Compensable Delay;
- .4 to a Subcontractor who contracts to perform a Compensable Change that is in fact wholly performed by another Subcontractor (for purposes of this Paragraph 7.7.7, "wholly performed" means that all of the Compensable Change, other than supervision or minor labor or materials, are furnished by such other Subcontractor); or
- .5 on any cost or compensation with respect to which the Contract Documents state that there shall be "no Allowable Markup", "no markup for overhead and profit" or words of similar meaning.

7.7.8 **Net Calculations.** If any one Change or collection of Changes in the same or related portions of the Work, or in multiple portions of Work covered by a single bulletin or instruction by County, involve both Compensable Change and Deleted Work, and if the added Allowable Costs resulting from the Compensable Change exceed the reduction calculated in accordance with Subparagraph 7.7.1.1 (4), (b), above, (excluding any Allowable Markup to the Contractor) then the calculation of Allowable Markups to Contractor shall be based on and limited to the resulting net increase in the Allowable Costs.

7.7.9 **Unit Prices.** Unless otherwise stated in the Contract Documents, unit prices stated in the Contract Documents or subsequently agreed upon by County and Contractor shall be deemed to include and encompass all costs of performance, overhead and profit, including, without limitation, all Allowable Costs and Allowable Markups. If the unit price stated in the Contract Documents is based on an estimated quantity established by County in the Construction Contract and the actual quantity of such unit-priced item varies by more than 25% above or below the estimated quantity, an equitable adjustment in the Contract Price shall be made upon demand of either County or Contractor. Such equitable adjustment shall be based solely upon any increase or decrease in Allowable Costs (without any Allowable Markups), due solely to the variation above 125% or below 75% of the estimated quantity.

**7.7.10 Discounts.** For purposes of determining Allowable Costs of a Compensable Change, all trade discounts, rebates, refunds, and returns from the sale of surplus materials and equipment shall accrue and be credited to County, and Contractor shall take all necessary steps to ensure that such discounts, rebates, refunds, and returns are secured.

**7.7.11 Prompt Pricing.** It is fundamental to the County's objective of controlling costs that performance of Compensable Changes on a time and materials basis of compensation and without a not-to-exceed price be curtailed. Contractor recognizes that prompt pricing by Contractor is critical to this objective. Accordingly, in addition to and without limitation on any of the County's other rights or remedies, including, without limitation, its right to enforce a waiver under Subparagraph 7.6.2.4, above, it is agreed that if Contractor fails to timely submit a complete Change Order Request in accordance with Paragraph 7.6.2, above, with respect to any circumstance, event or occurrence constituting a Compensable Change then: (1) any Delay to the performance of the Work associated with the performance, delayed performance or nonperformance of such Compensable Change shall be conclusively deemed to be an Unexcused Delay; and (2) the County shall have the option, exercised in its sole discretion, to unilaterally fix and determine the amount of the Contract Adjustment to the Contract Price for such Compensable Change based on the "estimating guide" method set forth in Subparagraph 7.7.1.1 (3), above, which determination shall be conclusively final and binding upon Contractor.

**7.7.12 Final Payment.** No Claim by Contractor for a Contract Adjustment shall be allowed if asserted after Final Payment.

**7.7.13 Full Resolution.** Except as otherwise stated in Paragraph 7.7.14, below, the signing of a Change Order by Contractor and the County shall be conclusively deemed to be a full resolution, settlement and accord and satisfaction with respect to any and all Loss and Delay, whether known or unknown at the time of execution of the Change Order, related to the subject matter of the Change Order, including, without limitation, all rights to recovery of costs, expenses or damages for delay, disruption, hindrance, interference, extended or extraordinary (direct and indirect) overhead, multiplicity of changes, loss of productivity, labor, wage or material cost escalations, inefficiency, legal expenses, consultant costs, interest, lost profits or revenue, bond and insurance costs, changes in taxes and other similar and related Losses. The foregoing provisions of this Paragraph 7.7.13 shall, whether or not they are expressly stated or referenced on the face of a Change Order, be deemed to be part of the terms of the Change Order and shall be deemed to supersede and govern over any other provision contained in any proposal, estimate or other documents attached to or referenced in such Change Order that conflicts with the provisions of this Paragraph 7.7.13. **ANY RIGHT OR CLAIM BY CONTRACTOR FOR ANY ADDITIONAL COMPENSATION OR EXTENSION OF TIME RELATING DIRECTLY OR INDIRECTLY TO A COMPENSABLE CHANGE DESCRIBED IN A FULLY EXECUTED CHANGE ORDER SHALL BE CONCLUSIVELY DEEMED WAIVED BY CONTRACTOR, EVEN IF THE CIRCUMSTANCES GIVING RISE TO SUCH ADDITIONAL COMPENSATION OR EXTENSION OF TIME WERE NOT SUSPECTED BY OR KNOWN TO THE CONTRACTOR AT THE TIME OF EXECUTION OF THE CONSTRUCTION CHANGE DIRECTIVE AND IF SUSPECTED OR KNOWN WOULD HAVE BEEN CONSIDERED BY CONTRACTOR TO HAVE BEEN MATERIAL TO CONTRACTOR'S AGREEMENT TO THE CONTRACT ADJUSTMENT SET FORTH IN THE CHANGE ORDER.**

**7.7.14 Reserved Rights.** Change Orders shall be executed by Contractor without any express reservation of rights by Contractor to reserve for the future the assertion of any right of recovery from the County for Loss or Delay arising out of or relating to the subject matter of the Change Order. Execution of a Change Order, Unilateral Change Order or Construction Change Directive shall not be interpreted as a waiver, release or settlement of any rights or claims that the County may have for any of the following: (1) Defective Work; (2) liquidated damages or actual Losses for Delay; or (3) recoupment by County (by way of withholding of funds, set off or recovery from Contractor) of amounts paid by County for costs or markups on costs that the County discovers, following payment of such amounts to Contractor, do not constitute proper charges to County, or that constitute charges that are not properly substantiated, under the terms of the Contract Documents.

**7.7.15 No "Total Cost" Calculations.** Contractor represents and warrants that it has the ability to generate and maintain complete and accurate cost accounting records that, if required, will reflect the actual costs of the Work incurred or avoided for multiple Compensable Changes and, on an event-by-event basis, the effect of multiple and concurrently occurring or caused Compensable Delays on the progress of the Work. Accordingly, Contractor agrees that all Change Order Requests and Claims shall be itemized in a manner that, with reasonable mathematical certainty and without reliance upon probabilities or inferences, segregates on a discrete, event-by-event



basis the direct, actual Allowable Costs associated with each individual Compensable Change or Compensable Delay. Unless otherwise agreed to by County in writing in the exercise of its sole discretion, Change Order Requests and Claims shall not be based, in whole or in part, upon any methodology (such as "total cost" or "modified total cost" methodologies) that purports to establish Contractor's entitlement to additional compensation inferentially based, solely or principally, on the difference between Contractor's total costs for the Work or a portion of the Work and its original Bid.

**7.7.16 Multiple Changes.** The County reserves the absolute right to make whatever Changes, including, without limitation, Compensable Changes or Deleted Work, that it determines, in its sole discretion, are necessary or otherwise desirable. Under no circumstances shall the individual or cumulative number, value or scope of such Changes, or their individual and cumulative impact on the Work, become a basis for Contractor to assert any claim for breach of contract, abandonment, rescission, termination, cardinal change or reformation of the Construction Contract, nor shall such circumstances be the basis for Contractor, or any of the Subcontractors, of any Tier, to assert a right of recovery of any Loss if such right is not permitted by, or is in excess of that allowed under, the Contract Documents.

**7.7.17 Continuous Performance.** Subject to Contractor's rights under Section 15.4, below, no dispute or disagreement with respect to any Changes or Delay, including, without limitation, disputes over Contractor's right to or the terms of a Contract Adjustment, shall relieve or excuse Contractor from the obligation to proceed with and maintain continuous, expeditious and uninterrupted performance of the Work, including performance of any disputed Changes.

## **ARTICLE 8 CONTRACT TIME**

### **8.1 COMMENCEMENT AND COMPLETION**

**8.1.1 Date of Commencement.** The Date of Commencement shall not be postponed by the failure of Contractor or of persons or entities for whom Contractor is responsible to perform an obligation. Contractor shall not knowingly, except by agreement or instruction of the County in writing, commence operations on the Site or elsewhere prior to receipt of a Notice to Proceed. Contractor shall not commence any Work at the Site prior to its obtaining the insurance required by Article 11, below, and the Performance Bond and Payment Bond required by Article 12, below, and the Date of Commencement of the Work shall not be changed by the effective date of such insurance or bonds.

**8.1.2 Substantial, Final Completion.** Contractor shall proceed expeditiously with adequate forces and shall achieve Substantial Completion and Final Completion within the Work Order Time, as adjusted for extensions of time duly permitted, authorized and noticed pursuant to Section 8.2, below.

**8.1.3 Adjustments to Contract Time.** Subject to the limitations set forth in this Article 8 and elsewhere in the Contract Documents, the Contract Time shall be extended for Compensable Delays and Excusable Delays and shall, where appropriate, be shortened for Deleted Work.

**8.1.4 Early Completion.** Nothing stated in these General Conditions or elsewhere in the Contract Documents shall be interpreted as creating any contractual right, express or implied, on the part of Contractor to finish the Work earlier than the Contract Time. Contractor has included in its Contract Price the costs of all Contractor's and its Subcontractors' direct and indirect overhead, including but not limited to all staff, temporary facilities, temporary utilities and home office overhead for the entire duration of the Contract Time. These costs have been included in the Contract Price notwithstanding Contractor's anticipation of possibly completing the Work in fewer Days than established by the Contract Time. Under no circumstances (including, without limitation, circumstances in which the County has approved in writing of Contractor completing early) shall the County be liable to Contractor for any Losses, of any kind, due to the inability of Contractor to complete the Work earlier than the Contract Time, regardless of the cause, including, without limitation, Delays due to acts or omissions (intentional or negligent) of the County, Inspectors of Record, County Consultants, Separate Contractors or others. If the Contractor anticipates completing early, it must obtain in advance County's approval in writing of such early completion. Approval by County of such early completion may be granted or withheld in the County's sole and absolute discretion.

## 8.2 DELAYS AND EXTENSIONS OF TIME

### 8.2.1 Adjustments to Contract Time of Work Order Time

**.1 Extensions.** Provided that Contractor has complied with the provisions of this Section 8.2 (including, without limitation, the requirements pertaining to timely delivery of a Notice of Delay and Request for Extension), if, as a result of Excusable Delay or Compensable Delay to the actual, as-built critical path of activities leading to achievement of Substantial Completion, Contractor is unable to achieve Substantial Completion within the Contract Time for Substantial Completion, then the Contract Time for Substantial Completion and Final Completion shall be extended, either by Change Order or Unilateral Change Order, for the length of the proven, resulting Delay to Contractor's ability to so complete the Work. The Contract Time shall not be adjusted for Unexcused Delays.

**.2 Shortening.** Contractor shall within ten (10) Days after receiving notice of Deleted Work prepare and deliver to County a Time Impact Analysis of the impact of the Deleted Work upon the critical path to determine if the Contract Time should be shortened thereby and if so the duration of the shortening. If the County and Contractor are unable to agree upon the duration of the shortening, then County shall make a Good Faith Determination of the reasonable amount of time that the Contract Time shall be shortened on account of such Deleted Work.

### **.3 Prescribed Calculations.**

**(1) Work Day Lost Calculations.** Contractor may claim an Excusable Delay or a Compensable Delay for a full Day only if all Work on a critical path activity is stopped for more than six (6) hours of a normal eight (8) hour Work Day and for a half-Day only if all Work on a critical path activity is stopped for three (3) to six (6) hours of such a normal Work Day. No Excusable Delay or Compensable Delay may be claimed if all Work on a critical path activity is stopped for less than three (3) hours of such a normal work Day. Similarly, where Deleted Work results in the projected avoidance of the need to perform more than six (6), or between three (3) and six (6) hours of all Work on a critical path activity on such a normal work day, the Contract Time shall be contracted by a full Day or half Day, respectively.

**(2) Dry Out Time Calculations.** Contract Adjustments to the Contract Time that are based upon unusual precipitation that is an Act of God as defined in Paragraph 1.1.2, above, shall include, in addition to the number of Days of Excusable Delay to which Contractor is entitled due to a cessation of Work that occurs at the Site while the unusual precipitation is occurring, an additional extension for the Delay to the critical path of activities affecting Substantial Completion that is the result of Contractor being unable, after cessation of the unusual precipitation at the Site, to proceed with performance of Work due to wet or muddy conditions at the Site (hereinafter referred to as "dry out" time); provided, however, that the amount of dry out time for which Contractor is entitled to an extension of time in any given calendar month shall not exceed the number of Days that is the product derived by multiplying (a) the number of Days of Excusable Delay to which Contractor is entitled due to a cessation of Work that occurs at the Site while such unusual precipitation is occurring, by (b) a fraction, the (i) numerator of which is the number of Days of Excusable Delay due to measurable unusual precipitation occurring at the Site during such calendar month that constitutes an Act of God as defined in Paragraph 1.1.2, above, and (ii) the denominator of which is the total number of Days of measurable precipitation occurring at the Site during said calendar month (including both the number of Days comprising the normal, 10-year monthly average of measurable precipitation recorded by NOAA and the excess, or unusual precipitation that constitutes an Act of God as defined in Paragraph 1.1.2, above).

### 8.2.2 Notice of Delay.

**.1 Submission.** Contractor shall submit written Notice of Delay to County if any instruction, request, drawing, specification, action, condition, omission, default or other circumstance occurs that constitutes an Excusable Delay or Compensable Delay or other matter that may involve or require a Contract Adjustment extending the Contract Time. Such notice shall be provided prior to performance of the Work affected or involved and no later than seven (7) Days after the Discovery Date of such circumstance.

**.2 Form.** Notices of Delay shall be provided using forms furnished by County or, if requested by County, using forms furnished by Contractor that are approved by County. Failure by County to request or approve a

particular form shall not relieve Contractor of its obligation to provide Notice of Delay in a written form that complies with the requirements of this Paragraph 8.2.2.

**.3 Content.** Each Notice of Delay in order to be considered complete shall include:

- (1) a general statement of the circumstances giving rise to the Notice of Delay (including, without limitation, identification of any related Construction Change Directive);
- (2) a Reasonable Order of Magnitude Estimate by Contractor of any related Contract Adjustments extending the Contract Time; and
- (3) if such circumstances involve a right to a Contract Adjustment to the Contract Price for Compensable Change that has not been waived by Contractor, Contractor shall include, if not previously provided, a complete and timely Notice of Change.

**.4 WAIVER BY CONTRACTOR.**

**FAILURE BY CONTRACTOR TO PROVIDE A COMPLETE AND TIMELY NOTICE OF DELAY UNDER CIRCUMSTANCES WHERE A NOTICE OF DELAY INVOLVING A DELAY IS REQUIRED BY THIS PARAGRAPH 8.2.2 SHALL, IN ACCORDANCE WITH THE PROVISIONS OF SECTION 4.6 OF THE GENERAL CONDITIONS, CONSTITUTE A WAIVER BY CONTRACTOR OF THE RIGHT TO A CONTRACT ADJUSTMENT ON ACCOUNT OF SUCH CIRCUMSTANCES AND A WAIVER OF ANY RIGHT TO FURTHER RECOURSE OR RECOVERY BY REASON OF OR RELATED TO SUCH DELAY.**

**.5 No County Notice.** Failure by Contractor to submit a timely or proper Notice of Delay under circumstances in which a Notice of Delay is required shall in no way affect County's right to a Contract Adjustment shortening the Contract Time on account of such circumstances.

**8.2.3 Request for Extension.**

**.1 Submission.** With respect to any matter that may involve or require an adjustment extending the Contract Time, Contractor shall, within fourteen (14) Days after receipt by County of a Notice of Delay pursuant to Paragraph 8.2.2, above, submit to County a written Request for Extension.

**.2 Form.** Requests for Extension shall be provided using forms furnished by County or, if requested by County, using forms furnished by Contractor that are approved by County. Failure by County to request or approve a particular form shall not relieve Contractor of its obligation to provide Requests for Extension in a written form that complies with the requirements of this Paragraph 8.2.3.

**.3 Content.** Each Request for Extension in order to be considered complete shall include:

- (1) a detailed description of the circumstances giving rise to the request for Contract Adjustment to the Contract Time and a Time Impact Analysis (a Request for Extension that seeks an extension for more than one Delay shall be supported by a separate Time Impact Analysis for each separate Delay); and
- (2) if such circumstances involve a right to a Contract Adjustment of the Contract Price on account of Compensable Change that has not been waived by Contractor, Contractor shall include, if not previously provided, a complete and timely Change Order Request.

**.4 WAIVER BY CONTRACTOR.**

**FAILURE BY CONTRACTOR TO PROVIDE A COMPLETE AND TIMELY REQUEST FOR EXTENSION UNDER CIRCUMSTANCES WHERE A REQUEST FOR EXTENSION INVOLVING A DELAY IS REQUIRED BY THIS PARAGRAPH 8.2.3 SHALL, IN ACCORDANCE WITH THE PROVISIONS OF SECTION 4.6 OF THE GENERAL CONDITIONS, CONSTITUTE A WAIVER BY CONTRACTOR OF THE RIGHT TO A CONTRACT ADJUSTMENT**

**ON ACCOUNT OF SUCH CIRCUMSTANCES AND A WAIVER OF ANY RIGHT TO FURTHER RECOURSE OR RECOVERY BY REASON OF OR RELATED TO SUCH DELAY.**

**.5 Adjustments Shortening Time.** Failure by Contractor to submit a timely or proper Request for Extension under circumstances in which a Request for Extension is required shall in no way affect County's right to a Contract Adjustment shortening the Contract Time on account of such circumstances.

**8.2.4 Response by County.** After receipt of a timely and complete Request for Extension, County shall investigate the facts concerning the cause and extent of such Delay and, depending on whether the Request for Extension is justified, will notify Contractor of its approval or disapproval of all or a portion of Contractor's request. Extensions of time approved by County shall apply only to that portion of the Work affected by the Delay, and shall not apply to other portions of Work not so affected.

**8.2.5 Formal Notice of Essence.** Contractor recognizes and acknowledges that timely submission of a formal Notice of Delay and a formal Request for Extension, whether or not the circumstances of a Delay may be known to County or available to County through other means, are not mere formalities but are of crucial importance to the ability of County to promptly identify, prioritize, evaluate and mitigate the potential effects of Delay. Any forms of informal notice, whether verbal or written (including, without limitation, statements at regular job meetings or entries in monthly reports, daily logs, job meeting minutes, updated Construction Schedules or look-ahead schedules), that do not strictly comply with the formal requirements of Paragraph 8.2.2, above, and Paragraph 8.2.3, above, shall accordingly be deemed insufficient to satisfy the notice requirements of this Article 8.

**8.2.6 Compensation for Delay.**

**.1 Compensable Delay.** Contract Adjustments to the Contract Price for a Compensable Delay that involve an extension of the Contract Time shall be based, without duplication to any other Contract Adjustments to the Contract Price, on the terms of Section 3.3 of the Construction Contract. Contractor agrees to accept such right of Contract Adjustment in lieu of any other right that may exist under Applicable Laws for recovery of Losses due to Compensable Delay, whether incurred by Contractor or its Subcontractors, of any Tier.

**.2 Deleted Work.** The Contract Time and Contract Price shall be reduced by Contract Adjustment for Deleted Work (including, without limitation, Deleted Work associated with a termination by County of a portion of the Construction Contract or a deletion of portion of Work for the convenience of the County or due to an Event of Contractor Default) that results in a shortening of the Contract Time.

**(1) Contract Time.** The Contract Adjustment shortening the Contract Time for Substantial Completion shall be the number of Days that Contractor at the time of contracting would have reasonably expected to expend in performance of the Deleted Work and that, based on the Contractor's original Construction Schedule prepared on or about the time of contracting, were reasonably expected by Contractor to be critical to Substantial Completion of the Work within the Contract Time for Substantial Completion.

**(2) Contract Price.** The Contract Adjustment reducing the Contract Price shall be the product of (1) the number of Days that the Contract Time for Substantial Completion is shortened pursuant to preceding Clause (1) of this Subparagraph 8.2.6.2 multiplied times (2) the amount of liquidated damages set forth in Paragraph 3.3.2 of the Construction Contract, without any additional credit to County for Allowable Markups.

**8.2.7 Acceleration of the Work.**

**.1 Due to Unexcused Delay.** If County makes a Good Faith Determination based on County's observations of progress in performance of the Work by Contractor that Contractor will not achieve Substantial Completion of the Work within the Contract Time as adjusted pursuant to Paragraph 8.2.1, above, then Contractor shall, following receipt of a written request by County to accelerate, immediately respond in writing setting forth a detailed plan for accelerating the Work. All measures necessary, including working overtime, additional shifts, Saturdays, Sundays and holidays, to accelerate performance to ensure that the Work is performed within the Contract Time shall be taken by Contractor and the cost thereof shall be paid for by Contractor at Contractor's Own Expense. County may also take all other necessary measures to ensure no further Delays affect achievement of Substantial

Completion and Final Completion of the Work within the Contract Time and the Contractor shall reimburse County, or County may withhold from payment due to Contractor, for Losses incurred by County in taking such measures.

**.2 Due to Excusable Delay.** Contractor shall have the right, exercised in its sole discretion, to accelerate performance of the Work to overcome time lost due to Excusable Delay. Such acceleration, if performed other than at the written direction of County, shall be deemed a voluntary acceleration and the cost of such accelerated performance shall be paid for by Contractor at Contractor's Own Expense. If County directs in writing that the Work be accelerated to overcome an Excusable Delay that is not concurrent with an Unexcused Delay, then Contractor shall be entitled to a Contract Adjustment to the Contract Price for such acceleration on and subject to the same terms as provided for in Subparagraph 8.2.7.3, below, in the case of an acceleration to overcome a Compensable Delay.

**.3 Due to Compensable Delay.** County shall have the right, exercised in its sole and absolute discretion, in lieu of granting a Contract Adjustment to the Contract Time for Compensable Delay, to direct in writing the acceleration of the Work by Contractor in order to recapture time lost due to such Compensable Delay. County and Contractor shall endeavor prior to commencement of such acceleration to mutually agree upon the amount of compensation to be paid therefor. County shall have the right, in the absence of such an agreement, to direct in writing that Contractor accelerate. Contractor shall comply with such directive. Contractor's right to a Contract Adjustment to the Contract Price on account of such acceleration shall be limited to (1) the premium time portion of any overtime paid for labor provided by Contractor or any Subcontractor, plus (2) additional supervision costs for additional shifts of supervision provided at the Site by Contractor only (not by Subcontractors), plus (3) Allowable Markup thereon as provided in Paragraph 7.7.5, above. Except as directed by County in the manner stated in this Subparagraph 8.2.7.3, no statements, conduct or actions by County will be construed as creating an obligation on the part of County to agree to a Contract Adjustment to the Contract Price on account of any cost of overtime or other costs associated with an acceleration of the Work to recapture time lost due to Compensable Delay.

**8.2.8 Concurrent Delays.** For purposes of the calculations provided for in this Paragraph 8.2.8, the words "concurrent delay", "concurrently delay" or "occur concurrently" mean the portion of two or more Delays affecting the critical path to Substantial Completion that are overlapping or co-existent. Contractor's right to a Contract Adjustment of the Contract Time (pursuant to Subparagraphs 8.2.8.1, 8.2.8.2 and 8.2.8.3, below) and Contract Price (pursuant to Subparagraphs 8.2.8.4, 8.2.8.5 and 8.2.8.6, below) shall, in the case of concurrent delays, be calculated in accordance with the following:

**.1** If an Excusable Delay and a Compensable Delay occur concurrently, the maximum extension of the Contract Time shall be the number of Days from the commencement of the first Delay to the cessation of the Delay which ends last.

**.2** If an Unexcused Delay occurs concurrently with either an Excusable Delay or a Compensable Delay, the maximum extension of the Contract Time shall be the number of Days, if any, by which such Excusable Delay or Compensable Delay exceeds the number of Days of such Unexcused Delay.

**.3** If an Unexcused Delay occurs concurrently with both an Excusable Delay and a Compensable Delay, the maximum extension of the Contract Time shall be the number of Days, if any, by which such Excusable Delay and Compensable Delay, as determined pursuant to Subparagraph 8.2.8.1, above, exceeds the number of Days of such Unexcused Delay.

**.4** If an Unexcused Delay occurs concurrently with a Compensable Delay, the maximum period of time for which Contractor shall be entitled to a Contract Adjustment to the Contract Price in accordance with Section 3.3 of the Construction Contract shall be the number of Days, if any, by which such Compensable Delay exceeds the number of Days of such Unexcused Delay.

**.5** If a Compensable Delay occurs concurrently with an Excusable Delay, the maximum period of time for which Contractor shall be entitled to a Contract Adjustment to the Contract Price in accordance with Section 3.3 of the Construction Contract shall be the number of Days, if any, by which such Compensable Delay exceeds the number of Days of such Excusable Delay.

.6 If an Unexcused Delay occurs concurrently with both an Excusable Delay and a Compensable Delay, the maximum period of time for which Contractor shall be entitled to a Contract Adjustment to the Contract Price in accordance with Section 3.3 of the Construction Contract shall be the number of Days, if any, by which such Compensable Delay exceeds the number of Days of such Unexcused Delay.

8.2.9 **Delay Claims.** Claims by Contractor relating to disputed Contract Adjustments due to Delay shall be made in accordance with applicable provisions of Section 4.3, above.

8.2.10 **Exercise of County Rights.** Notwithstanding any other provision of the Contract Documents to the contrary, County's exercise in accordance with the Contract Documents of any of its rights or remedies permitted by Applicable Laws or the Contract Documents in response to a failure by Contractor or any Subcontractor to comply with the Contract Documents shall not, under any circumstances, entitle Contractor to a Contract Adjustment.

## **ARTICLE 9 PAYMENTS AND COMPLETION**

### **9.1 PAYMENT BY COUNTY**

9.1.1 **Time for Payment.** County shall make payment of undisputed sums due to the Contractor upon Applications for Payment requesting Progress Payment not later than thirty (30) Days after receipt of an Application for Payment requesting Progress Payment that has been properly and timely prepared and submitted by Contractor, and approved by County, in accordance with the requirements of the Contract Documents.

9.1.2 **Not Acceptance.** No approval, inspection or use of, or payment for, the Work by County or by any person or entity acting on County's behalf, shall constitute acceptance of Work that is not in accordance with the Contract Documents or a waiver of any of County's rights under the Contract Documents.

9.1.3 **Interest.** If County fails to make payment of an undisputed sum due as a Progress Payment to the Contractor as required by this Article 9, County shall pay interest to the Contractor equivalent to the legal rate set forth in subdivision (a) of California Code of Civil Procedure §685.010. The number of Days available to the County to make payment without incurring such interest shall be reduced by the number of Days by which the County exceeds the seven (7) Day response time applicable to the County set forth in Section 9.5, below. The foregoing is the County's sole obligation with respect to payment of interest earned or accrued on an amount claimed due prior to the commencement by Contractor of legal proceedings for recovery of such amount.

9.1.4 **Disputed Payments.** Subject to Contractor's rights under Section 9.8, below, no good faith dispute or disagreement between County and Contractor with respect to the amount of any payment claimed due by Contractor shall relieve or excuse Contractor from the obligation to proceed with and maintain continuous, expeditious and uninterrupted performance of the Work.

### **9.2 APPLICATIONS FOR PAYMENTS**

9.2.1 **Submission by Contractor.** Applications for Payment requesting Progress Payment shall be properly prepared and submitted by Contractor to County once a month on the twenty-fifth (25<sup>th</sup>) Day of the month. If the twenty-fifth (25<sup>th</sup>) Day of the month is a weekend or Holiday, the Application for Payment shall be submitted on the next working day.

9.2.2 **Period of Application.** The period covered by each such Application for Payment requesting Progress Payment shall be not more than thirty (30) Days ending on the twenty-fifth (25<sup>th</sup>) Day of the month in which such Application for Payment is submitted.

9.2.3 **Schedule of Values.** Each Application for Payment shall be accompanied by a Schedule of Values prepared and submitted in accordance with the requirements of the Contract Documents, including, without limitation, the provisions of Section 9.3, below.

9.2.4 **Changes in Work.** Applications for Payment may include requests for payment on account of Compensable Changes in the Work which have been properly authorized by Change Order or Unilateral Change Order.

9.2.5 **Progress Payments.** Applications for Payment requesting Progress Payments shall be based on amounts calculated in accordance with the provisions of Section 9.4, below.

9.2.6 **Percentage Completion.** Applications for Payment requesting Progress Payments shall indicate the Contractor's estimate of the percentage of completion of each line item listed in the Schedule of Values as of the end of the period covered by the Application for Payment.

9.2.7 **Projected Work.** Unless approved by County in writing in advance of an Application for Payment being submitted, which approval may be granted or denied in the sole and absolute discretion of County, Applications for Payment shall only include amounts for Work performed to the twenty-fifth (25<sup>th</sup>) Day of the month in which the Application for Payment was submitted and shall not include request for payment of amounts for Work projected to be performed, stored or delivered beyond that date.

9.2.8 **Disagreements.** In the event of a disagreement between County and Contractor over the accuracy or reasonableness of the Contractor's statement of percentage of progress achieved that is contained in the Application for Payment, the County shall make a Good Faith Determination of the percentage, which percentage shall then be inserted by Contractor in the Application for Payment and the Application for Payment submitted, or resubmitted, incorporating such revision.

9.2.9 **Substantial Completion.** For the sole purpose of the percentage calculation set forth in Paragraph 9.2.6, above, and for no other purpose, the Work shall be deemed one hundred percent complete upon Substantial Completion and the amount released to Contractor shall, subject to County's right to withhold pursuant to Section 9.6, below, be a sum sufficient to increase the total of Progress Payments to Contractor to ninety-five percent (95%) of the Contract Price.

9.2.10 **Certification by Contractor.** Each Application for Payment that is submitted by Contractor shall be signed by Contractor with a certification by Contractor to County that: (1) the data comprising the Application for Payment is accurate and the Work has progressed to the point indicated; (2) to the best of Contractor's knowledge, information and belief, the Work is in accordance with the Contract Documents; (3) Contractor is entitled to payment in the amount certified; and (4) all sums previously applied for by Contractor on account of the Work performed by the Subcontractors and that have been paid by County have been paid to the Subcontractors performing such Work, without any retention, withholding or back charge by Contractor.

9.2.11 **Stored Materials.** County may, in the exercise of its sole and absolute discretion, approve or disapprove for inclusion in Contractor's Application for Payment the cost of materials to be incorporated, but not yet incorporated, in the Work and delivered and suitably stored either at the Site or at some other appropriate location acceptable to the County. As part of any request for such approval, Contractor shall furnish evidence satisfactory to County: (1) of the cost of such materials; (2) that such materials are under the exclusive control of Contractor, or if not, that title to the materials is in the County, free of any lien or encumbrance; and (3) with respect to materials stored off-Site, that the materials are safely and suitably stored in a bonded warehouse with appropriate insurance coverage satisfactory to County. No payment or approval by County pursuant to this Paragraph 9.2.11 shall (a) be construed as an inspection or acceptance of the materials; (b) relieve Contractor of its continuing and sole responsibility for the care and protection of, and sole responsibility for any Loss to, such materials, from any cause whatsoever; or (c) operate as a waiver of rights by County.

9.2.12 **Title.** Contractor warrants that title to all the Work covered by an Application for Payment will pass to County no later than the time of payment. Contractor further warrants that upon submittal of an Application for Payment all Work for which approval for payment has been previously issued by County shall, to the best of Contractor's knowledge, information and belief, be free and clear of liens, claims, security interests or encumbrances in favor of Contractor, the Subcontractors, material suppliers, or other persons or entities making a claim by reason of having provided labor, materials or equipment for the Work.

### 9.3 SCHEDULE OF VALUES

9.3.1 **Initial Submission.** Within twenty-one (21) Days after issuance by County of the Notice of Intent to Award, Contractor shall submit to County a Schedule of Values, prepared in a form and incorporating a level of detail satisfactory to County, that allocates the Contract Price to various portions of the Work, including, without limitation, each portion of the Work to be performed by a Subcontractor, self-performed Work, discrete categories of direct (i.e., on-Site) overhead costs (sometimes referred to as “general conditions costs”), Contractor home office and indirect overhead and profit and amounts reserved for contingencies.

9.3.2 **Balanced Allocation.** The Schedule of Values shall be balanced, reflecting in each line item Contractor's estimated or actual cost commitments for the category of Work included in the line item and a proportionate share of Contractor's overhead and profit. Techniques, such as “front-end loading”, designed to create an imbalanced cash flow are strictly prohibited.

9.3.3 **Line Estimates.** Line item values stated in the Schedule of Values that are based on Contractor's estimates, rather than actual subcontract prices, shall be identified as such and replaced with actual subcontract prices when they become available as the subcontracting process progresses.

9.3.4 **Updating.** The Schedule of Values shall be updated by Contractor each month as necessary to reflect the Contractor's actual progress in subcontracting the Work. An updated Schedule of Values shall be attached to each Application for Payment.

9.3.5 **Substantiation.** Contractor shall provide such data as County may reasonably require to substantiate that the Schedule of Values has been prepared in conformance with the requirements of the Contract Documents. Failure to provide such substantiation shall result in the Schedule of Values being deemed incomplete and unapproved by County for use by Contractor in submitting its Applications for Payment.

9.3.6 **Corrections.** If corrections are required in order to make the Schedule of Values comply with the requirements of the Contract Documents, such corrections shall be made as a condition of the Contractor's Application for Payment being considered properly prepared, submitted and complete.

9.3.7 **Changes to Work.** Costs involved in the performance of Work covered by Change Orders, Unilateral Change Orders or Construction Change Directives shall be, at the option of County, either separately scheduled or incorporated as adjustments to the respective trade lines of Work to which they apply. Except as otherwise expressly required by Article 7, above, the Schedule of Values shall not be utilized by Contractor as a basis for calculating Contract Adjustments.

9.3.8 **Applications for Payment.** The Schedule of Values prepared by Contractor in accordance with the requirements of the Contract Documents shall be used as a basis for County's review and approval or disapproval of Applications for Payment.

### 9.4 PROGRESS PAYMENT CONDITIONS

9.4.1 **Progress Payment Amount.** Subject to the other provisions of the Contract Documents, the amount of each Progress Payment requested in an Application for Payment shall be computed as follows:

.1 take that portion of the Work Order Amount properly allocable to Work (other than materials, products or equipment furnished by County) permanently incorporated at the Site as part of the Work, based on the product derived by multiplying (1) the percentage completion of each such portion of the Work times (2) the portion of the total Contract Price allocated to that portion of the Work in the Schedule of Values, less a retention of five percent (5%) thereof;

.2 add that portion of the Contract Price that is allocable to materials and equipment (other than materials, products or equipment furnished by County) approved by County pursuant to Paragraph 9.2.11, above, and suitably stored at the Site or at a location off-Site, less a retention of five percent (5%) thereof;



.3 subtract the aggregate of previous payments made by the County; and

.4 subtract amounts, if any, that County has determined will be withheld pursuant to an exercise of the County's right to withhold pursuant to Section 9.6, below.

9.4.2 **Other Conditions and Documentation.** Contractor shall submit its Applications for Payment requesting Progress Payments to County using such forms as required by County. Without limitation to any other conditions to payment set forth elsewhere in the Contract Documents, the following shall be conditions precedent to a proper submission, and to County's approval, of each Application for Payment:

.1 submission of a Schedule of Values that complies with Section 9.3, above;

.2 submission of Contractor's certification required by Paragraph 9.2.10, above;

.3 submission of: (1) forms of conditional releases of stop payment notice and bond rights upon progress payment, complying with California Civil Code §8132, for all Work performed during the time period covered by the current Application for Payment, signed by Contractor and the Subcontractors, of every Tier; and (2) forms of unconditional releases of stop payment notice and bond rights upon progress payment, complying with California Civil Code §8134, for all Work performed during the time period covered by the previous Application for Payment, signed by Contractor and the Subcontractors, of every Tier;

.4 compliance by Contractor with its obligation for daily maintenance of Record Drawings and Specifications as required by Paragraph 3.10.1, above;

.5 compliance by Contractor with its obligation for submission of daily reports as required by Paragraph 3.10.2, above;

.6 compliance by Contractor with its obligations for submission of scheduling information and updating of the Construction Schedule as required by Section 3.9, above, and other provisions of the Contract Documents pertaining to preparation or updating of schedules and scheduling information;

.7 proper payment of prevailing wages as defined in California Labor Code §1720, et seq.;

.8 timely submission of adequate and complete certified payroll records for any time period that Work was performed and for which payment is being requested;

.9 submission of certifications by Contractor and the Subcontractors as required by Applicable Laws certifying that all employee benefit contributions due and owing have been paid in full;

.10 submission of sales tax information as required by Paragraph 3.6.3, above; and

.11 compliance by Contractor with all of its other obligations for submission of documentation or performance of conditions which, by the terms of the Contract Documents, constitute conditions to Contractor's right to receive payment for Work performed.

## 9.5 COUNTY APPROVAL/REJECTION OF APPLICATIONS FOR PAYMENT

9.5.1 **Review by County.** Subject to County's rights under Paragraph 9.5.4, below, County shall promptly review Applications for Payment submitted by Contractor and provide its approval or disapproval, in whole or part, within (1) seven (7) Days after receipt of an Application for Payment requesting Progress Payment, and (2) within fourteen (14) Days after receipt of an Application for Payment requesting Final Payment.

9.5.2 **Disapproval by County.** Disapproval by County disapproving of an Application for Payment shall be accompanied by an explanation of the reasons for such disapproval. Failure by County to specify in its disapproval a particular grounds for disapproval of an Application for Payment shall not waive the County's right to

assert such grounds as a basis for any future disapproval, or nullification of its prior approval, of that or any other Application for Payment.

**9.5.3 Re-submittal by Contractor.** An Application for Payment that is disapproved by County shall be corrected and re-submitted by Contractor after receipt by Contractor of the notice of disapproval. A re-submitted Application for Payment shall be reviewed and responded to by County in the same manner as provided in Paragraphs 9.5.1 and 9.5.2, above. If re-submitted, the re-submitted Application for Payment shall be reviewed and responded to by County in the same manner as provided in Paragraph 9.5.1 and Paragraph 9.5.2, above. If not re-submitted, only the amount, if any, that is approved for payment shall be paid until such time as a proper Application for Payment that includes the disapproved amount has been submitted in another Application for Payment and, upon such re-submittal, approved for payment.

**9.5.4 Approval Nullification.** County reserves the right to nullify any prior approval of an Application for Payment that is later found to not be in compliance with the requirements of the Contract Documents, whether or not such noncompliance was previously actually observed or apparent on the face of the Application for Payment, and based on such nullification County may take either of the following actions, as applicable: (1) if the Application for Payment has not yet been paid by County, disapprove of that portion of the Application for Payment that is not in compliance and withhold payment of that sum until the noncompliance is fully rectified; or (2) if the Application for Payment has been paid by County, nullify the County's prior approval and withhold payment of such disputed amounts in response to future Applications for Payment; provided, however, that in either case the amount of the County's nullification shall be limited to that portion of the amount requested in the Application for Payment that is in dispute and the amount of its withholding from the current or any future Application for Payment shall be limited to the amount nullified plus any additional withholding permitted under Section 9.6, below.

**9.5.5 No Waiver by County.** Neither approval by County or Architect of, failure by County to exercise its right of nullification with respect to, nor payment by County upon, an Application for Payment or any portion thereof shall be interpreted as or constitute a waiver or release of any of County's rights to require Contractor's full compliance with the Contract Documents.

**9.5.6 No Representation.** Neither approval by County or Architect of, failure by County to exercise its right of nullification with respect to, nor payment by County upon, an Application for Payment or any portion thereof shall be interpreted as a representation that County or Architect has: (1) made exhaustive or continuous on-Site inspections to check the quality or quantity of the Work, (2) reviewed Contractor's construction means, methods, techniques, sequences or procedures, (3) reviewed copies of requisitions received from the Subcontractors and other data requested by County or Architect to substantiate Contractor's right to payment, or (4) made examination to ascertain how or for what purpose Contractor has used money previously paid on account of the Contract Price.

## **9.6 WITHHOLDING OF PAYMENT**

**9.6.1 Grounds for Withholding.** County may decline to approve an Application for Payment and withhold payment requested under any unpaid Application for Payment, in whole or in part, to such extent that County makes a Good Faith Determination that withholding is necessary, in the sole discretion of County, because of any of the following circumstances:

**.1 Third-Party Claims.** Third-party claims or stop payment notices filed or reasonable evidence (including, without limitation, failure by Contractor to submit conditional releases of stop payment notice and bond rights required by the Contract Documents) indicating the possible filing of such claims or stop payment notices.

**.2 Defective Work.** Defective Work not remedied.

**.3 Nonpayment.** Failure of Contractor to make proper payments to a Subcontractor for services, labor, materials or equipment or other Work.

**.4 Inability to Complete.** Reasonable doubt that the Work can be completed for the then unpaid balance of the Contract Price or within the Contract Time.

**.5 Violation of Applicable Laws.** Failure of Contractor or a Subcontractor to comply with Applicable Laws.

**.6 Penalty.** Any penalty asserted against County by virtue of Contractor's failure to comply with Applicable Laws.

**.7 Lack of Progress.** Failure by Contractor to maintain progress in accordance with the Construction Schedule.

**.8 Setoff.** Any reason specified elsewhere in the Contract Documents as grounds for a withholding, offset or setoff or that would legally entitle County to a setoff or recoupment.

**.9 Consultant Services.** Additional professional, consultant or inspection services required due to Contractor's failure to comply with the Contract Documents.

**.10 Liquidated Damages.** Liquidated damages payable to County pursuant to Section 3.2 of the Construction Contract or that there is a reasonable basis to believe will be payable to County based upon the Contractor's project date for Substantial Completion based on its update Construction Schedule or based upon other evidence available to County of the probable date that the Work will be Substantially Completed.

**.11 Damage.** Loss caused to County, a Separate Contractor or any other person or entity under contract to County, by Contractor or a Subcontractor.

**.12 Cleanup.** Cleanup performed by County and chargeable to Contractor pursuant to the terms of the Contract Documents.

**.13 Employee Benefits.** Failure of Contractor to pay contributions due and owing to employee benefits funds pursuant to any applicable collective bargaining agreement or trust agreement.

**.14 Required Documents.** Failure of Contractor to submit on a timely basis, proper and complete documentation required by the Contract Documents, including, without limitation, schedule updates, 'look ahead' schedules, pricing information, certifications and other required reports or documentation.

**.15 Labor Compliance.** Failure of Contractor or any Subcontractor to properly pay prevailing wages as defined in California Labor Code §§1720 et seq.

**.16 Nullification.** Nullification by County pursuant to Paragraph 9.5.4, above, of its prior approval of an Application for Payment.

**.17 Releases.** Failure by Contractor to submit any conditional release of stop payment notice and bond rights that is required pursuant to Subparagraph 9.4.2.3, above or Subparagraph 9.10.4.4, below.

**.18 Other Breach.** A breach by Contractor of any obligation or provision of the Contract Documents.

**9.6.2 Application of Withholding.** Sums properly withheld pursuant to Paragraph 9.6.1, above, may be used by County without a prior judicial determination of County's actual rights with respect to the grounds on which such withholding is based. Contractor agrees and hereby designates County as its agent for such purposes, and agrees that such payments shall be considered as payments made under the Construction Contract by County to Contractor. County shall submit to Contractor an accounting of such funds disbursed on behalf of Contractor. As an alternative to such payment, County may, in its sole and absolute discretion, elect to exercise its right to adjust the Contract Price as provided in Section 13.4, below.

**9.6.3 Final Payment.** In accordance with California Public Contract Code §7107, the amount to be withheld from Contractor's Final Payment pursuant to a withholding asserted pursuant to Paragraph 9.6.1, above, shall be limited to one hundred fifty percent (150%) of the disputed amount.

9.6.4 **Release of Withholding.** When the reasons for withholding of payment as set forth in Paragraph 9.6.1, above, are removed, approval by County will be promptly issued to Contractor for amounts previously withheld and payment of amounts withheld will be made by County within thirty (30) Days thereafter.

9.6.5 **Additional Rights.** The County's right of withholding set forth in this Section 9.6 is in addition to, and not a limitation upon, any other rights of withhold that County may have under the Contract Documents or Applicable Laws.

## 9.7 PAYMENTS BY CONTRACTOR

9.7.1 **Payments to Subcontractors.** Contractor shall not include in its Applications for Payment sums on account of any Subcontractor's portion of the Work that it does not intend to pay to such Subcontractor. Upon receipt of payment from County, Contractor shall pay the Subcontractors performing the Work, out of the amount paid to Contractor on account of such Subcontractors' portions of the Work, the amount to which said Subcontractors are entitled in accordance with the terms of their contracts with Contractor and Applicable Laws, including, without limitation, California Public Contract Code §7107. Contractor shall remain responsible, notwithstanding a withholding by County pursuant to the terms of these General Conditions, to promptly satisfy from its own funds sums due to all the Subcontractors who have performed the Work that is included in Contractor's Application for Payment. Contractor shall, by appropriate agreement, require each Subcontractor to make payments to its sub-subcontractors and suppliers in similar manner. County shall have no obligation to pay or be responsible in any way for payment to the Subcontractors, of any Tier.

9.7.2 **Payments in Trust.** Any funds that Contractor receives in payment for services or Work performed by a Subcontractor shall constitute assets of a trust, which trust funds shall be used for the exclusive benefit of the Subcontractor for the purpose of discharging Contractor's financial obligations on account of labor, services, materials or equipment furnished to the Project by the Subcontractor, provided that such labor, services, materials or equipment were performed in accordance with the Contract Documents, were included in an Application for Payment to County, and were paid by the County to Contractor. Contractor shall be the trustee of the trust and shall be required to deal with the trust assets for the benefit of the Subcontractor. Contractor shall not be a beneficiary of the trust. Nothing herein shall be construed as an intent to require that Contractor maintain trust funds in separate bank accounts, specifically designate any third party as a beneficiary of the trust created herein, or otherwise give rise to any cause of action against the County by any third party beneficiary of the trust created herein.

9.7.3 **Payment Information.** County will, on request, furnish to any of the Subcontractors, if practicable, information for such Subcontractor's review regarding percentages of completion or amounts applied for by Contractor and action taken thereon by County on account of portions of the Work done by such Subcontractor.

9.7.4 **Joint Payment.** County shall have the right, if deemed necessary in its sole discretion, to issue joint checks made payable to Contractor and any of the Subcontractors, of any Tier. The joint check payees shall be solely responsible for the allocation and disbursement of funds included as part of any such joint payment. Endorsement on such check by a payee shall be conclusively presumed to constitute receipt of payment by such payee. In no event shall any joint check payment be construed to create: (1) any contract between County and any of the Subcontractors, of any Tier; (2) any obligation from County to any of the Subcontractors; or (3) any third-party rights against County or Architect.

9.7.5 **Direct Negotiation of Stop Payment Notices.** County shall have the right to directly discuss, negotiate, settle or pay, without notice to or participation by Contractor, any stop payment notice claims asserted by the Subcontractors, of any Tier, and to deduct such sums paid from sums due to Contractor.

9.7.6 **Release of Stop Payment Notices.** With the exception of that portion, and only that portion, of a stop payment notice or other claim that arises as a result of a failure by the County to make payment to Contractor under circumstances constituting a breach of the Construction Contract by County, if any stop payment notice or other claim, whether invalid or valid, is filed with, served upon or made or asserted against the County or the Site by any Subcontractor, of any Tier, or their agent or employee, for money claimed due, then Contractor shall within five (5) Days after written notice by the County procure, furnish and record appropriate releases or other instruments which under Applicable Laws will fully release, extinguish and remove such stop payment notice or claim, as well as any notices of pending action or other notices recorded against the Site in connection with the enforcement

thereof. All costs of such actions by Contractor shall be paid for by Contractor at Contractor's Own Expense. Unless and until fully released as aforesaid, the County shall have the right to retain from any payment then due, or thereafter to become due, to Contractor an amount equal to one hundred and fifty percent (150%) of the amount necessary to satisfy, discharge and defend against any such stop payment notice or claim and any action or proceeding thereon, including, without limitation, an amount for anticipated attorney's fees and costs. If the amount to be paid, or the amount retained, is insufficient to satisfy, discharge and defend against any such stop payment notice or claim and any action or proceeding thereon, then Contractor shall be liable for the difference and upon demand shall immediately deposit the same with the County. The provisions of this Paragraph 9.7.6 are in addition to such other rights as the County may have against Contractor under the Contract Documents or Applicable Laws.

**9.7.7 No County Obligation.** Neither County nor Architect shall have any obligation to pay or to see to the payment of money to any of the Subcontractors except as may otherwise be required by Applicable Laws.

## **9.8 FAILURE OF PAYMENT**

If, through no fault of Contractor or failure by Contractor to comply with its obligations under the Contract Documents either: (1) approval or disapproval by County of an Application for Payment properly prepared and submitted by Contractor and requesting payment that is otherwise undisputed by County is not issued within the time period required therefor by the terms of this Article 9; or (2) the County does not (a) upon an Application for Payment properly prepared and submitted by Contractor pay to Contractor, within the time period required for payment by County, an undisputed amount approved by County as earned, which approval has not been, and is not thereafter, nullified by County, or (b) pay to Contractor an amount that has been awarded by arbitration or judgment of a court of competent jurisdiction, then Contractor may, following delivery to County of a written "10-day stop work order", stop the Work until, as applicable, an approval or disapproval by County, or payment by County, is received by Contractor. Promptly upon receipt of such approval or disapproval, or payment, as applicable, Contractor shall resume the Work. Any resulting Delay associated with the shut down and start up of the Work as a result of Contractor's proper exercise of its right to stop work under this Section 9.8 shall constitute a Compensable Delay.

## **9.9 SUBSTITUTION OF SECURITIES FOR RETENTION**

**9.9.1 Public Contract Code.** Pursuant to the requirements of California Public Contract Code §22300, upon the Contractor's request, the County will make payment to the Contractor of any funds withheld from payments to ensure performance under the Contract Documents if the Contractor deposits with the County, or in escrow with a California or federally chartered bank in California acceptable to the County ("Escrow Agent"), securities eligible for the investment of State Funds under Government Code §16430, or bank or savings and loan certificates of deposit, interest-bearing demand deposit accounts, standby letters of credit, or any other security mutually agreed to by the Contractor and the County, upon the following conditions:

**.1** The Contractor shall be the beneficial owner of any securities substituted for monies withheld for the purpose of receiving any interest on such securities.

**.2** All expenses relating to the substitution of securities under said §22300 and under this Section 9.9, including, but not limited to the County's overhead and administrative expenses and expenses of Escrow Agent, shall be the responsibility of the Contractor.

**.3** Securities or certificates of deposit substituted for monies withheld shall be of a value of at least equivalent to the amounts of the retention to be paid to the Contractor pursuant to the Contract Documents.

**.4** If the Contractor shall choose to deposit securities in lieu of monies withheld with an Escrow Agent, the Contractor, the County and Escrow Agent shall, as a prerequisite to such deposit, enter into an escrow agreement. Such escrow agreement shall be substantially in the form "Escrow Agreement for Security Deposits in Lieu of Retention" set forth in California Public Contract Code §22300(f).

**.5** The Contractor shall obtain the written consent of Surety to such agreement.

**.6** Securities, if any, shall be returned to the Contractor only upon satisfactory Final Completion of the Work.

9.9.2 **Substitute Security.** To minimize the expense caused by such substitution of securities, the Contractor shall, prior to or at the time the Contractor requests to substitute security, deposit sufficient security to cover the entire amount to be withheld. Should the current market value of such substituted security at any time fall below the amount for which it was substituted, or any other amount which the County withholds pursuant to the Contract Documents, the Contractor shall immediately and at the Contractor's Own Expense deposit additional security qualifying under said §22300 until the current market value of the total security deposited is no less than the amount subject to withholding under the Contract Documents. Securities shall be valued as often as conditions of the securities market warrant, but in no case less frequently than once per month.

9.9.3 **Deposit of Retentions.** Alternatively, subject to the conditions set forth in Paragraph 9.9.1, above, upon request of the Contractor, the County shall make payment of retentions directly to Escrow Agent at the expense of the Contractor, provided that the Contractor, the County and Escrow Agent shall, as a prerequisite to such payment, enter into an escrow agreement in the same form as prescribed in Subparagraph 9.9.1.4, above. At the Contractor's Own Expense, the Contractor may direct the investment of the payments into securities and interest bearing accounts and the Contractor shall receive the interest earned on the investments. Escrow Agent shall hold such direct payments by the County under the same terms provided herein for securities deposited by the Contractor. Upon satisfactory Final Completion of the Work, the Contractor shall receive from Escrow Agent all securities, interest and payments received by Escrow Agent from the County, less escrow fees and charges of the Escrow Account, according to the terms of said §22300 and the Contract Documents.

## 9.10 FINAL PAYMENT

9.10.1 **Payment by County.** Subject to the County's right of withholding as set forth in Section 9.6, above, or elsewhere in the Contract Documents, Final Payment shall be made by County not more than sixty (60) Days after completion of the Work as defined in Clauses (1), (2), (3) or (4) of California Public Contract Code § 7107(c), whichever definition is earliest satisfied.

9.10.2 **Application for Final Payment.** Upon issuance by County of the Notice of Final Completion pursuant to Paragraph 9.13.5, below, Contractor shall submit to County its Application for Payment requesting Final Payment.

9.10.3 **Review by County.** County will review and approve or disapprove of the Application for Payment requesting Final Payment as provided in Section 9.5, above.

9.10.4 **Conditions to Final Payment.** Without limitation to any other conditions to payment set forth elsewhere in the Contract Documents, the following shall be conditions to a proper submission, and to County's approval, of Contractor's Application for Payment requesting Final Payment:

- .1 submission of Contractor certification as required by Paragraph 9.2.10, above;
- .2 submission of consent of Surety, if any, to Final Payment;
- .3 submission of a certificate evidencing that the insurance required by the Contract Documents is in force;
- .4 submission of conditional releases and waivers of stop payment notice and bond rights upon final payment in the form required by California Civil Code §8136 executed by Contractor and by all the Subcontractors, of every Tier;
- .5 submission of all Close-Out Documents (including, without limitation, complete, accurate Record Drawings and Specifications certified by Contractor as required by Paragraph 3.10.1, above);
- .6 timely submission of adequate and complete certified payroll records for any time period that Work was performed, which have not been submitted by Contractor in connection with its previous Applications for Payment;

.7 proper payment of prevailing wages as defined in California Labor Code §§1720, et seq.;

.8 submission of certifications by Contractor and each Subcontractor, as required by any applicable collective bargaining agreement or trust agreement or Applicable Laws, certifying that all employee benefit contributions due and owing have been paid in full; and

.9 submission of any other documents or information required by the Contract Documents as a condition of Final Payment or Final Completion.

9.10.5 **Disputed Amounts.** Pursuant to California Public Contract Code § 7107, County may deduct and withhold from Final Payment an amount of up to one hundred fifty percent (150%) of any disputed amounts, including, without limitation, amounts to protect County against any Loss caused or threatened as a result of Contractor's failing to fully satisfy the conditions of Final Completion and Final Payment.

9.10.6 **No Waiver by County.** The making of Final Payment by County shall not constitute a waiver by County of any rights or claims, including, without limitation, any right or claim for reimbursement of Allowable Costs or Allowable Markup paid to Contractor that is determined by County, either before or after Final Payment, to have been not due to Contractor.

#### 9.10.7 **WAIVER BY CONTRACTOR.**

**ACCEPTANCE OF FINAL PAYMENT BY CONTRACTOR OR A SUBCONTRACTOR SHALL CONSTITUTE A WAIVER OF ALL RIGHTS BY THAT PAYEE AGAINST COUNTY FOR RECOVERY OF ANY LOSS, EXCEPTING ONLY THOSE CLAIMS THAT HAVE BEEN SUBMITTED BY CONTRACTOR IN THE MANNER REQUIRED BY SECTION 4.3, ABOVE, PRIOR TO, OR AT THE TIME OF CONTRACTOR'S SUBMISSION TO COUNTY OF, ITS APPLICATION FOR PAYMENT REQUESTING FINAL PAYMENT.**

#### 9.11 **SUBSTANTIAL COMPLETION**

9.11.1 **Contract Time.** Contractor shall achieve Substantial Completion of the Work, or such portion of the Work as may be designated at any time by County for separate delivery, in accordance with the requirements of the Contract Time and other provisions of the Contract Documents.

9.11.2 **Request for Inspection.** Contractor shall notify the County when Contractor believes that the Work, or portion thereof designated by the County in the Contract Documents or otherwise for separate delivery, is Substantially Complete.

9.11.3 **Substantial Completion Inspection.** When Contractor gives notice to County that it has achieved Substantial Completion of the Work, or a County designated portion thereof, unless the County determines that the Work or County designated portion thereof is not sufficiently complete to warrant an inspection to determine Substantial Completion, County, Inspector of Record, Architect and such others as may be designated by County will inspect the Work, or such County designated portion thereof.

9.11.4 **Substantial Completion Punch List.** At the conclusion of such inspection, County shall prepare and give to Contractor (or, Owner may request that Contractor prepare and provide to County) a Substantial Completion Punch List of items, if any, to be completed or corrected for Substantial Completion. If Contractor disputes any of the items included, it shall so note its objection on the Substantial Completion Punch List. Contractor shall proceed within forty-eight (48) hours after preparation of the Substantial Completion Punch List to commence correction or completion of the items on the Substantial Completion Punch List, including, without limitation, any disputed items, and all such items of Work shall be completed promptly by Contractor before the Work will be considered as Substantially Complete. Failure by County, Architect, Inspector of Record or Contractor to include an item on the Substantial Completion Punch List does not alter the responsibility of Contractor to perform the Work in accordance with the Contract Documents. Items of Work necessary for Substantial Completion that, for any reason, have been omitted from the Substantial Completion Punch List shall be added to the Substantial Completion Punch List and Contractor shall, at the request of County, Architect or Inspector of Record made at any time prior to Final Payment commence correction or completion of such items within forty-eight (48) hours and all such items of Work shall be completed by Contractor promptly and before the Work will be considered as Substantially Complete.

9.11.5 **Re-Inspection.** Contractor shall notify County when the items of Work shown on the Substantial Completion Punch List are completed. County, Inspector of Record, Architect and such others as County deems necessary or appropriate will then make a further inspection to determine whether such Work is Substantially Complete. If such inspection, or any subsequent re-inspection required pursuant hereto, discloses any item, whether or not included on the Substantial Completion Punch List, which must be completed or corrected before Substantial Completion, Contractor shall, as a condition of Substantial Completion, complete or correct such item, which shall then be re-inspected to confirm that such Work is Substantially Complete. Contractor shall reimburse County, or County may at its option withhold from Contractor's payments, amounts incurred by County to the Inspector of Record, Architect, County Consultants or others whose services, for reasons within the control or responsibility of Contractor or the Subcontractors, are necessary for more than two (2) such re-inspections to determine Substantial Completion.

9.11.6 **Notice of Substantial Completion.** When County determines that the Work, or such designated portion thereof, is Substantially Complete, County will prepare a Notice of Substantial Completion on the County's form, which shall state the date of Substantial Completion. If the Notice of Substantial Completion is for the entire Work, then the County will attach to it the Final Completion Punch List prepared in accordance with Paragraph 9.13.2, below. Regardless of the date the Notice of Substantial Completion is issued, Substantial Completion shall be deemed to have occurred on the date stated in the Notice of Substantial Completion.

## 9.12 PARTIAL OCCUPANCY OR USE

County reserves the right to beneficially occupy all or any portion of the Work at any time before Substantial Completion of the entire Work. Beneficial occupancy means that County has assumed physical occupancy and use of all or such portion of the Work. Commencement of improvements or other work by Separate Contractors in order to ready the Work for use or occupancy by County shall be unconditionally permitted in all cases prior to Substantial Completion and shall not constitute a taking of beneficial occupancy by County. Exercise by County in accordance with the provisions of this Section 9.12 of its right to take beneficial occupancy shall not constitute grounds for a Contract Adjustment. The County's right of beneficial occupancy of all or a portion of the Work prior to Substantial Completion shall be subject to the following conditions:

9.12.1 County and such others as County deems necessary will make an inspection of the portion of the Work to be beneficially occupied and prepare a list of items to be completed or corrected in the same manner as required by and subject to the same conditions as set forth in Section 9.11, above.

9.12.2 Beneficial occupancy by County shall not be construed as Acceptance of that portion of the Work which is to be occupied.

9.12.3 Except as otherwise provided in this Section 9.12, beneficial occupancy by County shall not constitute a waiver of rights of the County against Contractor. Notwithstanding anything stated in this Section 9.12 or elsewhere in the Contract Documents to the contrary, beneficial occupancy by County shall not constitute a waiver of rights of County relating to Defective Work in the area beneficially occupied or in any other portion of the Work.

9.12.4 Prior to the County's taking beneficial occupancy, Contractor shall submit to County an itemized list of each piece of equipment located in or serving the area to be occupied stating the date operation of such piece of equipment commenced, together with operating instructions, manuals and other information required by the Contract Documents. Contractor shall provide, in the areas beneficially occupied, on a continual basis, utility services, elevator service, and heating and cooling systems in operable condition commencing at the time of beneficial occupancy and until Final Completion of the entire Work. County shall be responsible, from and after taking occupancy, for utility consumption, regular operation and regular maintenance of such systems or equipment.

9.12.5 County shall pay all normal operating and maintenance costs resulting from its use of equipment in areas beneficially occupied.

9.12.6 County shall pay all utility costs that arise out of its beneficial occupancy.

9.12.7 Contractor shall not be responsible for providing security in areas beneficially occupied.



9.12.8 County shall use its best efforts to prevent its beneficial occupancy from interfering with the conduct of Contractor's remaining Work.

9.12.9 Contractor shall not be required to repair damage caused solely by County's beneficial occupancy.

9.12.10 Contractor shall continue to maintain all insurance required by the Contract Documents in full force and effect.

### 9.13 FINAL COMPLETION

9.13.1 **Contract Time.** Contractor shall expeditiously and diligently perform the Work after Substantial Completion, including, without limitation, all items of Work on the Final Completion Punch List that accompanies the Notice of Substantial Completion, so as to achieve Final Completion within the requirements of the Work Order Time for Final Completion.

9.13.2 **Final Completion Punch List.** Contractor shall prepare and submit to County at the time that Contractor requests inspection for Substantial Completion of the entire Work pursuant to Paragraph 9.11.2, above, a draft proposed Final Completion Punch List of items of Work that will be required to be completed or corrected for Final Completion. Items identified in the course of any inspection for Substantial Completion that are required to Finally Complete the Work following Substantial Completion shall be added to the proposed Final Completion Punch List and the revised Final Completion Punch List attached to the Notice of Substantial Completion. If Contractor disputes any of the items included, it shall so note its objection on the Final Completion Punch List. When Contractor considers the Final Completion Punch List to be complete, it shall promptly sign and deliver the Final Completion Punch List to the County. Failure by County, Architect, Inspector of Record or Contractor to include an item on the Final Completion Punch List does not alter the responsibility of Contractor to perform the Work in accordance with the Contract Documents. Items of Work necessary for Final Completion that, for any reason, have been omitted from the Final Completion Punch List shall be added to the Final Completion Punch List upon request by the County made at any time prior to Final Payment and completion of such items shall be made promptly and before the Work will be considered Finally Complete.

9.13.3 **Performance of Punch List.** Contractor shall proceed promptly and in accordance with the Contract Time to correct and complete the items on the Final Completion Punch List, including, without limitation, any disputed items, and all such items of Work shall be completed by Contractor before the Work will be considered as Finally Complete.

9.13.4 **Request for Final Inspection.** Contractor shall notify County when Contractor believes that the Work is Finally Complete. County, Inspector of Record, Architect and such others as County deems necessary or appropriate will then make a further inspection to determine whether such Work is Finally Complete. If such inspection, or any subsequent re-inspection required pursuant hereto, discloses any item, whether or not included on the Final Completion Punch List, which must be completed or corrected before Final Completion, Contractor shall, as a condition of Final Completion, complete or correct such item, which shall then be re-inspected to confirm that such Work is Finally Completed. Contractor shall reimburse County, or County may at its option withhold from Contractor's payments, amounts incurred by County to the Inspector of Record, Architect, County Consultants or others whose services, for reasons within the control or responsibility of Contractor or the Subcontractors, are necessary for more than two (2) inspections to determine Final Completion.

9.13.5 **Notice of Final Completion.** When County determines that the Work is Finally Complete, County will prepare a Notice of Final Completion on the County's form, which shall state the date of Final Completion. Regardless of the date the Notice of Final Completion is issued, Final Completion shall be deemed to have occurred on the date stated in the Notice of Final Completion.

.1 For EZIQC Work Order Contracts, after the final inspection by County and all the contract documentation for the Contract has been received, it will be recommended to the County Board of Supervisors to accept the Work and file a Notice of Completion. Upon approval of the Notice of Completion, a copy will be sent to the Contractor (see final payment clause) and recorded in the office of the County Recorder. Upon Acceptance of the Work, Contractor will be relieved of the duty of maintaining and protecting the Work. Neither determination by the

County that the Work is complete, nor Acceptance thereof, shall operate as a bar to County's claim against Contractor pursuant to Contractor's warranty and guarantees.

9.13.6 **Notice of Completion.** In addition to issuance of the Notice of Substantial Completion and Notice of Final Completion, County shall have the right, exercised in its sole and absolute discretion, to record a Notice of Completion pursuant to California Civil Code §9204.

9.13.7 **No Waiver by County.** No inspections conducted pursuant to this Article 9 nor any approvals or certificates issued by County, Architect or Inspector of Record shall be deemed to be a waiver or limitation on County's right to insist on Final Completion and full performance of all other conditions to Final Payment under the Contract Documents prior to issuance of Final Payment to Contractor.

## **ARTICLE 10 INSPECTIONS, SAFETY AND HAZARDOUS SUBSTANCES**

### **10.1 INSPECTIONS**

10.1.1 **General.** One or more Inspectors of Record, including special inspectors as required, may be employed by County and assigned to the Work. The fees of Inspectors of Record shall be directly paid for by County. IF INSPECTORS OR RECORD ARE ASSIGNED TO THE WORK, THEN NO WORK SHALL BE CARRIED ON EXCEPT UNDER THE INSPECTION, AND WITH THE KNOWLEDGE, OF THE APPROPRIATE INSPECTOR(S) OF RECORD, and Contractor shall be responsible, at Contractor's Own Expense, to remove and replace any Work performed without such inspection by the appropriate Inspector of Record.

10.1.2 **Coordination.** Contractor shall schedule, arrange, and coordinate its activities with the activities of the County, Inspectors of Record, Architect, County Consultants and others designated by County to inspect or observe the Work. When, in order to comply with the intent of the Contract Documents, inspection or observation must be made at the plant or mill of the manufacturer or fabricator of material or equipment, Contractor shall notify the County, as well as any other persons identified by County as assigned by it to inspect or observe the Work, a sufficient length of time in advance to allow for arrangements to be made for such inspection or observation.

10.1.3 **Uncovering of Work.** County or an Inspector of Record shall have the right to request that any portion of the Work be uncovered by Contractor for inspection. Except as otherwise provided in Paragraph 10.1.1, above, if such Work is found to be in accordance with the Contract Documents, then all of the additional costs incurred in uncovering, replacing and re-covering the Work shall constitute grounds for Contractor, upon proper notice and request pursuant to Article 7, above, to receive a Contract Adjustment for Compensable Change and if such uncovering, replacing and re-covering of the Work causes a Delay, such Delay shall constitute grounds for Contractor, upon proper and timely notice and request pursuant to Article 8, above, to receive a Contract Adjustment for Compensable Delay. If such Work is not in accordance with the Contract Documents, then such costs of uncovering, replacing and re-covering shall be paid for by Contractor at Contractor's Own Expense and any resulting Delay shall be consider an Unexcused Delay.

10.1.4 **Off-Hours Inspections.** Contractor shall request approval by County before arranging any inspections either: (1) before 7:00 am or after 3:00 pm on Monday through Friday, or (2) on any Saturday, Sunday, holiday or any other time when Work is not usually in progress. Such request shall be delivered to County at least two (2) working days in advance of the inspection being performed. Approval or disapproval of such request is in the sole and absolute discretion of County. Except where such off-hours inspections are due to a breach by County of an obligation under the Contract Documents, the additional cost (over and above that which would be required for inspections during regular business hours) to County of the inspection shall be paid for by Contractor at Contractor's Own Expense.

10.1.5 **Access to the Work.** Contractor shall make available for use by County, Inspectors of Record, Architect, County Consultants and others assigned to inspect or observe the Work, any equipment (wheelbarrow, shovel, ladder, man-lift, etc.) that is available or in use on Site, and is required to assist in such inspections or observations.

10.1.6 **Right to Stop Work.** County shall have the right, but not the obligation, to order Contractor to stop performance of Work. Inspectors of Record shall, only if and to the extent permitted by Applicable Laws or if they are given written authority to do so by County, have the authority, but not the obligation, to stop the Work whenever provisions of Contract Documents are not being complied with, or the conduct of the Work poses a probable risk of harm to persons or property.

10.1.7 **No County Duty.** No authority of the County, Inspectors of Record, Architect, County Consultants or others designated by County to inspect the Work that is conferred by the Contract Documents nor any decision made by any of them in good faith either to exercise or not exercise such authority, nor any recommendation by any of them, shall give rise to a duty or responsibility on the part of any of them to Contractor or to the Subcontractors, of any Tier.

10.1.8 **Contractor Responsibility.** Inspections or observations by the County, Inspectors of Record, County Consultants or others shall not in any way relieve Contractor from its sole responsibility for full compliance with all of the terms and conditions of the Contract Documents, nor be construed to lessen, to any degree, Contractor's responsibility for providing efficient and capable superintendence as required herein or for incorporating into the Work only those items of the Work that conform to the Contract Documents.

10.1.9 **Reimbursement to County.** Without limitation to any other provisions of the Contract Documents, Contractor shall reimburse the County at Contractor's Own Expense, or County shall have the right, at its option, to withhold from payments due to Contractor, costs of inspections, observations or testing and other Losses that are incurred for any of the following reasons: (1) Contractor has failed to execute the Work in accordance with the Contract Documents; (2) materials or equipment have been substituted by Contractor, without prior approval by the County and Architect; (3) Defective Work; or (4) to conduct load testing of certain portions of the structure that have not fully met the requirements of the Contract Documents.

## 10.2 SAFETY PRECAUTIONS AND PROGRAMS

10.2.1 **General Safety Obligation.** Contractor shall, notwithstanding the activities of others (such as, but not limited to, the County, Architect, Inspectors of Record, County Consultants or others designated by County to prepare safety recommendations or inspect or observe the Work), be solely responsible, on a twenty-four (24) hours a Day, seven (7) Days a week basis, for initiating, maintaining and supervising all safety precautions and programs on the Site in connection with the preparation, performance, observation or inspection of the Work, including all necessary precautions to protect and safeguard all persons and property from loss, injury, death or damage resulting, directly or indirectly, from the activities of Contractor or the Subcontractors, including, without limitation, all of the following:

- .1 persons in and around the Site, as well as their personal property and vehicles;
- .2 the Work, materials and equipment to be incorporated therein under care, custody or control of Contractor or the Subcontractors, of any Tier, whether in storage on or off the Site, including, without limitation, the provision of temperature control, covering and enclosures necessary to prevent Loss due to adverse weather conditions;
- .3 other property at the Site or adjacent thereto, such as trees, shrubs, lawns, walks, pavements, curbs, roadways, structures (including, without limitation, protection from settlement or loss of lateral support) and utilities not designated for removal, relocation or replacement in the course of construction; and
- .4 construction and operations by the County, Architect and Inspectors of Record.

10.2.2 **Contractor's Safety Program.** Prior to starting the Work, Contractor shall prepare and submit to County a Safety Program, which shall comply with the requirements of the Contract Documents and shall include, at a minimum, guidelines, requirements and procedures for the following: safety management policy; emergency response plan; illness and injury prevention procedures; safety meetings; accident investigation; basic accident causes; safety inspection checklist; fire prevention and control; report forms; and employee safety manual and procedures for achieving compliance with safety requirements of insurers. A copy of the Safety Program shall be

maintained on Site at all times and provided to the County upon request. Contractor is solely responsible for monitoring activities at the Site for compliance with the Safety Program and for the enforcement thereof.

10.2.3 **Safety Orders.** Contractor shall comply with all Applicable Laws, including, without limitation, all safety laws, standards, orders, rules, regulations and building codes, to prevent accidents or injury to persons on, about or adjacent to the Site and to provide a safe and healthful place of employment. Contractor shall, at Contractor's Own Expense, correct any violations of Applicable Laws occurring or threatened by conditions on the Site.

10.2.4 **Safety Representative.** Contractor shall designate a responsible member of its organization on the Site, who meets the qualification and competency requirements of Applicable Laws and whose sole duty shall be giving safety instructions, prevention of accidents and overall job site safety (including, without limitation, posting of information and other notices regarding safety that are required under occupational safety and health laws and compliance with reporting and other occupational safety requirements pertaining to the protection of the life, safety and health of the workers). The name of the person so designated shall be reported to the County by Contractor prior to the commencement of any Work on the Site.

10.2.5 **Protection.** Contractor shall take reasonable precautions to protect the Work and all building materials, equipment, temporary field offices, storage sheds, and other public and private real and personal property that might be affected, directly or indirectly, by Contractor's activities associated with performance of the Work, and shall make good, at Contractor's Own Expense, all Loss due to failure to provide such reasonable precautions.

10.2.6 **Safeguards, Disabled Access.** Contractor shall erect and maintain, as required by existing conditions and performance of the Work, all necessary safeguards for safety and protection, including, without limitation, safety devices, belts, nets, barriers, safety rails, canopies, danger signs, fire protection, no smoking prohibitions, warnings against hazards, safety regulations postings and notifications to owners and users of adjacent sites and utilities, and shall, as required by Applicable Laws, make provision for access for, and provide assistive devices to, persons with disabilities, including, without limitation, providing safe pathways of travel around areas where construction is being performed so that occupants, visitors, the public and others on the Site with disabilities are afforded reasonably direct and barrier-free access to areas of the Site and Existing Improvements.

10.2.7 **Fire, Explosives, Hazardous Substances.** Contractor shall take all necessary precautions to guard against and eliminate possible fire hazards. Explosives may be used or stored only when authorized in writing by the County. Explosives shall be handled, used and stored in accordance with Applicable Laws. When use or storage of explosives or other Hazardous Substances or methods of construction involving use of dangerous materials or equipment are necessary for execution of the Work, Contractor shall exercise utmost care and carry on such activities under supervision of properly qualified personnel.

10.2.8 **First Aid.** Contractor shall maintain emergency first aid treatment for all workers and other persons on the Project which complies with the Federal Occupational Safety and Health Act of 1970 (29 U.S.C.A. §§651 et seq.) and all other Applicable Laws.

10.2.9 **Unsafe Conditions.** Contractor shall immediately correct any condition that exists on the Site, or that County, in its reasonable judgment, determines to exist on the Site, that is unsafe or potentially unsafe to persons or property.

10.2.10 **Responsibility for Loss.** Contractor shall promptly remedy Loss to any property or person caused in whole or in part by the failure of Contractor, the Subcontractors, of any Tier, or anyone directly or indirectly employed by any of them, or by anyone for whose acts they may be liable to fully comply with the requirements of this Article 10, except Loss attributable solely to the negligent acts or omissions of the County, Inspectors of Record, Architect, County Consultants or anyone directly or indirectly employed by any of them, or by anyone for whose acts any of them may be liable, and not attributable, in whole or in part, to the negligence, willful misconduct or violation of Applicable Laws by Contractor or a Subcontractor, of any Tier, or the failure by Contractor to comply with the Contract Documents. The foregoing obligations of Contractor are in addition to and not a limitation upon Contractor's indemnity obligations under Section 3.18, above.

10.2.11 **Loading, Storage.** Contractor shall be responsible for coordinating the storage and staging of materials and equipment on-Site and off-Site and shall not load or store or permit any part of the Work or the Site to be loaded or stored so as to endanger the safety of persons or risk loss or damage to property.

10.2.12 **Emergency.**

.1 **Contractor Responsibility.** In an emergency involving safety or protection of persons or property, Contractor shall act immediately, either at County's direction or as otherwise necessary under the circumstances, to prevent any Loss. In such cases, Contractor shall immediately notify County, which notice may be oral, followed within twenty-four (24) hours after occurrence of the incident by written confirmation of the occurrence of such emergency and Contractor's action in response thereto.

.2 **County Action.** If, in the sole discretion of County, the condition is immediately threatening life or property, County may, with or without notice to Contractor, take whatever immediate action is necessary to correct the life-threatening condition, and the costs thereof, including, without limitation, any fees or costs of Architect, Inspectors of Record, County Consultants or others to whom County may be liable, shall be borne by Contractor at the Contractor's Own Expense.

10.2.13 **No County Responsibility.** Nothing set forth in this Section 10.2 or elsewhere in the Contract Documents shall be interpreted as an assumption of any responsibility on the part of County or other persons or entities other than the Contractor and the Subcontractors, to report such conditions to Contractor nor as relieving Contractor of any of its responsibilities under the Contract Documents.

10.2.14 **Separate Contractors.** With respect to work of a Separate Contractor being performed within an area of the Site that is under the responsibility or control of the Contractor, Contractor shall: (1) provide copies of the Safety Program to the Separate Contractors and advise the Separate Contractors of the areas of the Site to which the Safety Program applies and where compliance with the Safety Program is expected; (2) protect the Separate Contractors' work and workers from Loss due to the actions or inactions of Contractor and the Subcontractors; and (3) notify the Separate Contractor and County of any observed violation by the Separate Contractor of the Safety Program or of any violations by the Separate Contractor of Applicable Laws governing safety on the Site. Nothing herein shall be interpreted as relieving the Separate Contractors from their obligations to comply with the Contractor's Safety Program, as excusing any failure by a Separate Contractor from performing its obligations under its contracts with County or Applicable Laws or as obligating Contractor to directly supervise or enforce the obligations of the Separate Contractors to comply with the requirements of the Safety Program or Applicable Laws relating to safety.

10.3 **HAZARDOUS SUBSTANCES, MOLD**

10.3.1 **Hazardous Substances.**

.1 **On Site Conditions.**

(1) **Existing Conditions.** In the event Contractor or its Subcontractors encounter materials existing or otherwise present at the Site that are reasonably believed to be Hazardous Substances that have not been rendered harmless, Contractor and Subcontractors shall, except in cases where the removal, encapsulation or abatement of such Hazardous Substances is indicated by the Contract Documents to be part of the Work to be performed by Contractor, immediately stop Work in the area affected and report the condition to County in writing. Contractor and Subcontractors shall continue Work in unaffected areas reasonably believed safe. County shall then promptly arrange for the sampling, testing and profiling of such suspected Hazardous Substances to confirm the nature, quantity or concentration thereof. In the event that such suspected Hazardous Substances are determined not to be Hazardous Substances or to be Hazardous Substances but not of sufficient nature, quantity or concentration to trigger handling and manifesting of the same as a hazardous waste upon disturbance and removal, then Contractor and its Subcontractors shall, without any Contract Adjustment, be obligated to resume the portion of the Work that was suspended and shall proceed to handle and dispose of such materials pursuant to the Contract Documents, taking all reasonable precautions that are applicable under the circumstances. If, alternatively, the suspected Hazardous Substances are determined to be Hazardous Substances of sufficient nature, quantity or concentration to trigger handling and manifesting of the same as hazardous waste upon disturbance and removal, the parties shall

determine what, if any, action to take with respect to such Hazardous Substances, whether to resume Work with respect to such Hazardous Substances, taking all reasonable precautions that are applicable under the circumstances, and what, if any, Contract Adjustment is appropriate and mutually agreed in order to account for any increased cost of, or Delay in connection with, handling or disposal of Hazardous Substances not already contemplated and provided for in the Contract Documents.

**(2) Contractor Release.** Contractor and its Subcontractors shall not cause the discharge, release, emission, spill, storage, treatment or disposal of any Hazardous Substance on or adjacent to the Site, except as required and permitted by the Contract Documents and Applicable Laws in connection with Contractor's performance of an obligation to remove Hazardous Substances as part of the Work agreed to be performed under the Contract Documents or as otherwise required under the provisions of this Subparagraph 10.3.1.1. Should Contractor or its Subcontractors discharge, release, emit, spill, treat, store or dispose of any Hazardous Substance on the Site in violation of the foregoing obligation or otherwise in violation of Applicable Laws, Contractor shall at Contractor's Own Expense and without limitation to County's other rights or remedies for default immediately (a) inform County in writing of such event, (b) advise County with respect to any release reporting or notification requirement that may apply as a result of such event, (c) assist County in complying with any such reporting or notification requirement as determined by County, and (d) perform any investigation, remediation, removal or other response that is necessary or desirable in order to abate or clean up the condition resulting from such event to the full satisfaction of County and any applicable Governmental Authority. Such Hazardous Substances shall be removed and properly disposed of as soon as they can be accepted at an appropriate disposal facility, and in no event later than sixty (60) Days after such waste is generated, unless a longer time is approved by County.

## **.2 Remediation by Contractor.**

**(1) Application.** The provisions of this Paragraph 10.3.1.2 shall apply only if the Work to be performed by Contractor includes within its scope the removal, abatement, moving, handling, containment, disposal or transport of Hazardous Substances

**(2) Advance Submissions to County.** Before Contractor or any of its Subcontractors moves, removes, or transports Hazardous Substances to a facility for the receipt, treatment, storage or disposal of the Hazardous Substances ("Hazardous Substances Facility"), Contractor shall cause the person or entity who will be moving, removing or transporting the Hazardous Substances to provide to County the following: (a) verification of the Hazardous Substance Facility's or other transporter's licensed status to haul such materials; (b) verification of the Hazardous Substance Facility's licensed status, including a current permit to receive the specific materials to be transported there; (c) certification that the Hazardous Substance Facility is not under enforcement action by the U.S. Environmental Protection Agency ("EPA") or applicable State Governmental Authority or listed on any applicable EPA or applicable State Government Authority list of violating facilities; (d) verification of the Hazardous Substances Facility's EPA Identification Number (if applicable); and (e) original executed letter(s) of indemnity from the Hazardous Substances Facility bearing the Hazardous Substance Facility's letterhead. Contractor further warrants that the selected Hazardous Substance Facility is appropriately licensed and permitted to store, treat and dispose of Hazardous Substances waste in connection with the Work.

**(3) Contractor Responsibility.** Contractor warrants that it is aware of and understands the hazards which are presented to persons, property and the environment in performance of the transportation, storage and disposal of the Hazardous Substances described in the Contract Documents. Contractor and its Subcontractors and agents shall be responsible for the following: (a) processing the application for, and receiving on behalf of the County or appropriate entity, an EPA or state-equivalent generator identification number (if required); (b) preparing manifests and other shipping documents; (c) making all necessary arrangements (after consultation with County) for any off-Site transportation, treatment, storage and disposal of such Hazardous Substances in accordance with Applicable Laws; (d) ensuring the proper and lawful transportation and disposal of such Hazardous Substances, even if such services are performed by other entities under contract with Contractor or its Subcontractors; and (e) taking any necessary actions to ensure such proper transport and disposal in the event of any contingency, such as the rejection of the Hazardous Substances as nonconforming by any waste disposal facility. Contractor shall promptly provide to County copies of all manifests and other shipping documents confirming the receipt and proper disposal of all Hazardous Substances at the Hazardous Substances Facility, even if such services are performed by other entities under contract with Contractor or its Subcontractors.

**(4) Reporting Requirements.** Contractor shall comply with any Hazardous Substances release reporting requirements to Governmental Authorities directly applicable to Contractor. Notice of such reporting must be provided in advance to County or concurrently in the event of an emergency.

**(5) Samples.** Contractor and its Subcontractors shall retain all media samples for the longer of (a) the longest holding period specified in any federal, state or local laboratory analytical procedures or guidance for the analyses performed; or (b) three months for soil samples and thirty (30) Days for water samples. Further storage or transfer of samples will be made at County's expense upon County's written request of Contractor. Contractor shall require by contract that each and every Subcontractor and agent of Contractor or a Subcontractor who performs testing of samples in connection with the Work properly disposes of such samples in accordance with Applicable Laws after completion of testing and notice to County. Regarding any such samples which may remain on-Site, provided County has approved of such on-Site storage in advance, County agrees to pay all costs associated with the storage, transport, and disposal of such samples.

**(6) Verification.** Upon Final Completion of the Work, Contractor shall confirm to County in writing that: (a) all Hazardous Substances specified for removal in the Contract Documents have been removed; and (b) all Hazardous Substances wastes removed from the Site as part of the Work have been disposed of in accordance with this Subparagraph 10.3.1.2 and Applicable Laws in a Hazardous Substances Facility.

**10.3.2 Mold.** Contractor is responsible to immediately notify County in writing if any conditions in the construction materials incorporated or to be incorporated into the Work or present in Existing Improvements are encountered at the Site that Contractor or any Subcontractor knows or, in the exercise of due care of a Contractor and not that of a consultant with special or technical expertise in the subject of Mold, should know indicate the presence of Mold or if untreated are likely to result in the growth of Mold. Contractor shall thereafter take such precautions as are reasonably required to prevent the exposure of persons to such conditions until they have been evaluated. Except as otherwise authorized by the Contract Documents or as are usual and customary according to prevailing standards of the construction industry in the vicinity of the Project, Contractor shall not allow water or moisture to come into contact with materials in Existing Improvements or with materials located at the Site that are incorporated or to be incorporated into the Work and if such contact occurs, the areas affected shall be inspected by Contractor, using appropriate consultants experienced in testing and evaluating Mold, for the presence of Mold and evaluated for the potential of future growth of Mold. All portions thereof that are found to indicate the presence of Mold, or that are found to be in a condition that has the potential for becoming a source of Mold, shall be removed and replaced. Costs incurred by Contractor due to its failure to perform its obligation under this Paragraph 10.3.2 shall be borne by Contractor at Contractor's Own Expense.

**10.3.3 Release of County.** Contractor assumes the risk that its employees or the employees of its Subcontractors, and other persons that they cause or permit to be present on the Site, may be exposed to known or unknown Hazardous Substances or Mold. Under no circumstances shall County be liable for, and Contractor hereby fully and unconditionally releases County and the other Indemnitees from, and agrees to defend and indemnify County and the other Indemnitees on the terms set forth in Section 3.18, above, against, any and all known and unknown Losses resulting from or relating to the exposure of any employee of Contractor or its Subcontractors, or other person that they cause or permit to be present on the Site, to: (1) Hazardous Substances or Mold encountered in connection with or as a result of the performance of the Work, or (2) Hazardous Substances or Mold not necessarily encountered in connection with the performance of the Work, but to which any of them may nevertheless be exposed as a result of their being present on the Site.

**10.3.4 Communications with Governmental Authorities.** Contractor shall provide to County copies of all written communications with Governmental Authorities or others relating to Hazardous Substances or Mold (other than privileged communications); provided, however, that non-disclosure of privileged communications shall not limit Contractor's obligation to otherwise comply with the terms of the Contract Documents, including, without limitation, this Section 10.3.

**10.3.5 Subcontractors.** Contractor shall include provisions in all contracts it enters into with Subcontractors for the Work requiring them to assume toward Contractor and County the same obligations that Contractor assumes toward County under this Section 10.3. Contractor shall require the Subcontractors to ensure that such provisions are included in all contracts they enter into with all lower-Tier Subcontractors.

## ARTICLE 11 INSURANCE

### 11.1 INSURANCE

11.1.1 **Contractor's Insurance Requirements.** Without limiting or diminishing any of the Contractor's obligations to defend, indemnify or hold the County harmless as set forth elsewhere in the Contract Documents, Contractor shall procure and maintain or cause to be maintained throughout the performance of the Work and for the duration of any guarantee or warranty provided under the Contract Documents, at Contractor's Own Expense, the following insurance coverages:

**.1 Workers' Compensation.** If the Contractor has "employees", as defined by the State of California, the Contractor shall provide a policy of statutory Workers' Compensation Insurance (Coverage A) as prescribed by the laws of the State of California. Such policy shall include Employers' Liability (Coverage B) including Occupational Disease with limits not less than \$1,000,000 per person per accident. Such policy shall be endorsed to waive subrogation in favor of the County and, if applicable, to provide a Borrowed Servant/Alternate Employer Endorsement. Pursuant to §3700 of the California Labor Code, Contractor shall file with the County before commencing the Work the following signed certification:

*"I am aware of the provisions of Section 3700 of the Labor Code, which requires every employer to be insured against liability for workers' compensation or to undertake self-insurance in accordance with the provisions of that Code, and I shall comply with such provisions before commencing the performance of the Work of this Construction Contract."*

**.2 Commercial General Liability.** Contractor shall provide a policy of Commercial General Liability insurance coverage, including but not limited to, premises liability, contractual liability, products and completed operations liability, personal and advertising injury, and cross liability coverage, covering claims which may arise from or out of Contractor's performance of its obligations hereunder. Such policy shall name the County, its agencies, districts, special districts and departments, and their respective directors, officers, elected or appointed officials, agents, employees and representatives, including, without limitation, the members of the Board of Supervisors, and all other Indemnitees, as "additional insureds" and contain a waiver of subrogation in favor of the County and all other such additional insureds. Such policy's limit of liability shall not be less than \$1,000,000 per occurrence combined single limit. If such policy contains a general aggregate limit, it shall apply separately to the Construction Contract or be no less than two (2) times the occurrence limit.

**.3 Vehicle Liability.** If vehicles or mobile equipment are used in the performance of the Work or other obligations under the Contract Documents, then Contractor shall provide a policy of liability insurance coverage for all owned, non-owned or hired vehicles so used in an amount not less than \$1,000,000 per occurrence combined single limit. If such policy contains a general aggregate limit, it shall apply separately to the Construction Contract or be no less than two (2) times the occurrence limit. Such policy shall name the County, its agencies, districts, special districts and departments, and their respective directors, officers, elected or appointed officials, agents, employees and representatives, including, without limitation, the members of the Board of Supervisors, and all other Indemnitees, as "additional insureds" and contain a waiver of subrogation in favor of the County and all other such additional insureds.

**.4 Property (Physical Damage).** Contractor shall provide a policy of all-risk property insurance coverage for the full replacement value of all Contractor's equipment, improvements/alterations, temporary structures, and systems, including without limitation, items owned by others in the Contractor's care, custody or control, used on the Site or other County-owned property, or used in any way connected with the performance of the Work.

11.1.2 **Other Mandatory Insurance Requirements.** The Contractor shall comply with the following requirements, which shall be deemed applicable to all carriers and insurance policies provided pursuant to Paragraph 11.1.1, above:



**.1 Insurer Rating.** Any and all insurance carrier(s) providing insurance coverage under any and all policy(ies) of insurance provided by Contractor pursuant to Paragraph 11.1.1, above, shall be admitted to the State of California and have an A M BEST rating of not less than A: VIII (A:8) (unless such requirements are waived in writing by the County Risk Manager, and if the County's Risk Manager waives such requirement for a particular insurer such waiver is only valid for that specific insurer and only for one policy term);

**.2 Self Insured Retentions.** Contractor shall advise County in writing the dollar amount of any "self insured retention" maintained by the Contractor that exceeds \$500,000 per occurrence. Each such self insured retention must have the prior written consent of the County Risk Manager before the commencement of any Work or operations or activities relating to the Work. If Contractor is notified that a self insured retention is unacceptable to the County, then at the election of the County, exercised in the County's sole and absolute discretion, by means of the written approval of the County's Risk Manager, the insurance carriers affected shall either: (1) reduce or eliminate such self-insured retention as respects the Construction Contract; or (2) procure a bond, satisfactory to County and approved by County in writing, which guarantees payment of losses and related investigations, claims administration, and defense costs and expenses.

**.3 Evidence of Insurance.** Contractor shall cause Contractor's insurance carrier(s) to furnish to the County either: (1) properly executed original certificate(s) of insurance and certified original copy(ies) of endorsement(s) effecting the coverage(s) required by this Section 11.1, or (2) if requested to do so orally or in writing by the County Risk Manager, provide original, certified copy(ies) of policy(ies) including all endorsement(s) and all attachment(s) thereto, showing such insurance is in full force and effect. Such certificate(s) and all policies of insurance provided by Contractor pursuant to this Section 11.1 shall contain the covenant of the insurance carrier(s) that thirty (30) Days' written notice shall be given to the County prior to any material modification, cancellation, expiration or reduction in coverage of such insurance. Each certificate of insurance and endorsement shall be signed by an individual expressly authorized by the insurance carrier to do so on the carrier's behalf. Contractor shall, if requested, provide written proof of such authorization. ***Contractor shall not commence any Work or any activities or operations related to the performance of the Work unless and until Contractor has complied with all of the requirements of this Section 11.1.***

**.4 Modification, Cancellation, Changes in Limits.** A material modification, cancellation, expiration, or reduction in coverage, shall constitute an Event of Contractor Default for which County shall have right, without limitation to its other rights or remedies provided for in the Contract Documents or under Applicable Laws, to terminate this Construction Contract. Such Event of Contractor Default may only be deemed cured if the County receives, prior to the effective date of such material modification, cancellation, expiration or reduction in coverage, properly executed original certificate(s) of insurance and original, certified copy(ies) of policy(ies) and endorsement(s), including all attachment(s) thereto, evidencing that the coverage(s) required by this Section 11.1 is(are) and will continue, without any gap in coverage, in full force and effect in accordance with all of the requirements of this Section 11.1

**.5 Primary Coverage.** It is understood and agreed to by County and Contractor that the Contractor's insurance coverage(s) provided under this Section 11.1 shall be construed as primary insurance, and the County's insurance and/or deductibles and/or self-insured retentions or self-insured programs shall not be construed as contributory.

**.6 Additional Coverages.** County reserves the right to modify, adjust, add to and/or increase the types, amounts and terms of any insurance required under this Section 11.1 if the County Risk Manager determines, in the exercise of his/her sole and absolute discretion, that the type, amount or terms of the insurance required by this Section 11.1 has(have) become inadequate or that additional risk or exposure exists (such as, without limitation, the use of aircraft, watercraft, cranes, etc.) due to: (1) a Change in the Work; (2) the period of time of Contractor's actual performance of the Work continuing for longer than five (5) years from the Date of Commencement, whether due to Contract Adjustment or for any for any other reason; or (3) other circumstances not reasonably foreseeable to County.

**.7 Subcontractors.** Contractor shall include provisions in its subcontracts requiring each Subcontractor to assume an obligation toward Contractor to furnish insurance that complies with all of the requirements of this Section 11.1 as apply to Contractor's insurance provided to Owner and requiring such Subcontractors to furthermore include provisions in their contracts with lower-Tier Subcontractors likewise requiring

such lower Tier Subcontractors assume the same obligations for providing such insurance and for passing through all such obligations to all lower Tier Subcontractors.

**.8 Self-Insurance.** If approved by County, in the exercise of its sole and absolute discretion, the insurance requirements contained in this Section 11.1 may be met with a program(s) of self-insurance provided that such program has been submitted to County and approved in writing by County prior to commencement of the Work or of any activity or operation related to the performance of the Work.

**.9 Notice of Claim.** Contractor agrees to notify County of any claim by a third party or any incident or event that may give rise to a claim arising from the performance of the Work.

## **ARTICLE 12 BONDS**

### **12.1 PERFORMANCE BOND AND PAYMENT BOND**

**12.1.1 Performance and Payment Bonds.** Within ten (10) Days after the issuance of the Notice of Intent to Award and prior to commencing Work, Contractor shall deliver to County a good and sufficient labor and materials payment bond ("Payment Bond") and a good and sufficient performance bond ("Performance Bond"), each in the amount of one hundred percent (100%) of the Contract Price.

**12.1.2 Changes.** The penal amounts of the Performance Bond and Payment Bond shall be increased on account of Change Orders and Unilateral Change Orders increasing the Contract Price. If requested by County, Contractor shall deliver to County evidence of such increases.

**12.1.3 Replacement.** Should any bond required hereunder or any Surety on such bond become or be determined by County to be insufficient, it shall be replaced within ten (10) Days by a bond that fully complies with the requirements of this Section 12.1.

**12.1.4 Duration.** The Payment Bond shall remain in effect until Acceptance of the Work and all Claims of Contractor and the Subcontractors, of any Tier, have been fully and finally resolved. The Performance Bond shall remain in effect and assure faithful performance of all Contractor's obligations under the Contract Documents, including, without limitation, all warranty obligations.

**12.1.5 Condition of Payment.** No payments to Contractor for Work performed shall be made or due until there has been full compliance with the requirements of this Section 12.1.

**12.1.6 Surety Rating.** Any Surety company issuing the Payment Bond or Performance Bond shall be, at all times while such bond is in effect, an Admitted Surety. The Surety company issuing the Performance Bond shall additionally have at all such times a current A.M. Best rating of A VIII (A:8) or better.

**12.1.7 Premiums.** The premiums for the Performance Bond and Payment Bond are included in the Contract Price and shall be paid by Contractor at Contractor's Own Expense.

**12.1.8 Obligee.** The Performance Bond shall name County as obligee. All performance bonds, if any, purchased by Subcontractors shall name County as a dual obligee with Contractor.

**12.1.9 No Exoneration.** The Performance Bond and Payment Bond shall contain provisions to the effect that Changes, Change Orders, Unilateral Change Orders, Construction Change Directives, Modifications, Changes and Contract Adjustments shall in no way release or exonerate Contractor or its Surety from their obligations and that notice thereof is waived by the Surety.

**12.1.10 Communications.** County shall have the right to communicate with Surety with respect to matters that are related to performance of the Work. Contractor shall be provided with a copy of all such communications that are in writing. Such communications shall not create or be interpreted as creating any contractual obligation of County to Surety.

12.1.11 **No Limitation.** The requirements of this Section 12.1 pertaining to the Performance Bond and the Payment Bond shall be without limitation to any other obligations Contractor may have under Applicable Laws to provide bonding for the benefit of, and to assure payment to the Subcontractors performing the Work for, the Project.

12.1.12 **Subcontractor Bonds.** Each performance bond, if any, furnished by a first-Tier Subcontractor shall include a provision whereby the Surety consents to the contingent assignment of Contractor's rights under such bond to County as provided in Section 5.3, above.

12.1.13 **Claims.** By incorporation of the Construction Contract into the Performance Bond issued by Surety, Surety shall be deemed, subject to the other terms of the Performance Bond, to be bound by all of the obligations assumed by Contractor under the Contract Documents, including, without limitation, bound by any determination, resolution, award or judgment entered or made upon any Claim by or against Contractor.

## **ARTICLE 13 UNCOVERING AND CORRECTION OF THE WORK**

### **13.1 UNCOVERING OF THE WORK**

If a portion of the Work is covered contrary to the request or direction of County, Inspector of Record or Architect, or contrary to the requirements of the Contract Documents, it must, if required by the any of them, be uncovered for observation and be re-covered by Contractor at Contractor's Own Expense.

### **13.2 CORRECTION OF THE WORK**

Contractor shall promptly correct Defective Work, whether discovered before or after Substantial Completion and whether or not fabricated, installed or completed. All such Defective Work shall be either: (1) replaced and all the Work disturbed thereby made good by Contractor at Contractor's Own Expense; or (2) County may exercise its option pursuant to Section 13.4, below, to accept such Work and adjust the Contract Price.

### **13.3 GUARANTEE TO REPAIR PERIOD**

13.3.1 **Guarantee To Repair Period.** Besides guarantees and warranties required elsewhere in the Contract Documents, Contractor guarantees the Work as provided hereinbelow. The period of this guarantee, termed the "Guarantee To Repair Period," is for one (1) year commencing as follows:

.1 for any portion of the Work that, upon Substantial Completion of the overall Work, is fully and finally complete and usable in all respects independent of other portions of the Work that are not fully and finally complete, on the date of Substantial Completion of such portion of the Work;

.2 for space beneficially occupied or for separate systems fully utilized prior to Substantial Completion, from the first date of such beneficial occupancy or full utilization, as established by an appropriate written notice by County of intent to take beneficial occupancy; or

.3 for all Work other than that described in Subparagraph 13.3.1.1, above or Subparagraph 13.3.1.2, above, from the date of Final Completion of the Work.

13.3.2 **Repair by Contractor.** Subject to the provisions of Paragraph 13.3.3, below, Contractor shall do the following: (1) correct, repair, replace, remove and restore, to the County's satisfaction, any Defective Work that becomes apparent during the progress of the Work or during the Guarantee To Repair Period; (2) correct, repair, replace, remove and restore, to the County's satisfaction, any other parts of the Work and any other real or personal property which is damaged or destroyed as a result of Defective Work or the correction of Defective Work; and (3) remove from the Site all the Work identified by the County as Defective Work, whether incorporated or not and whether discovered before or after Substantial or Final Completion. Ordinary wear and tear, abuse, or neglect by County or by County employees, its staff, visitors, public or others (except for those under the control or responsibility of Contractor or its Subcontractors) who are authorized or admitted by County to enter, use or occupy the Work, or

who enter, use or occupy the Work after Final Completion, are excepted from the foregoing guarantee. All Losses resulting from Defective Work, including, without limitation, all costs of such correction, repair, replacement, removal and restoration, additional testing, inspection and additional service fees and costs of the Inspector of Record, Architect, County Consultants or others whose services may be made necessary thereby as well as any Loss to any other parts of the Work and any other real or personal property which is damaged or destroyed as a result of Defective Work or the correction, repair, replacement, removal or restoration of Defective Work, shall be paid for by Contractor at Contractor's Own Expense. Contractor shall correct, repair, replace, remove and restore Defective Work at such times as are acceptable to the County and in such a manner as to avoid, to the greatest extent practicable, disruption to the activities of the County, its staff, visitors, the public or others. Contractor shall notify the County in writing upon the completion of such correction, repair, replacement, removal and restoration.

**13.3.3 Notice by County.** Except as otherwise provided in this Paragraph 13.3.3 where immediate corrections are needed due to dangerous conditions or risk of imminent Loss or interruption of County operations, the County will give notice to Contractor of Defective Work observed prior to Final Completion in accordance with the provision of Section 15.1, below, governing the occurrence of an Event of Contractor Default and the Contractor shall proceed to cure such Event of Contractor Default in accordance with the requirements of Section 15.1, below, and Paragraph 13.3.2, above. With respect to Defective Work observed after Final Completion, the County will give notice to Contractor with reasonable promptness and Contractor shall commence the correction, repair, replacement, removal and restoration as required by Paragraph 13.3.2, above, no later than ten (10) Days after mailing of such notice to Contractor and Contractor shall thereupon diligently and continuously prosecute such correction, replacement, repair, or restoration to completion. Notwithstanding the foregoing, if in the County's opinion the presence of Defective Work, whether observed prior to Final Completion or after Final Completion and during the Guarantee To Repair Period, poses a risk or threat: (1) to life, safety or the protection of property; (2) of imminent Loss to the County or to any other person or entity; or (3) of causing an interruption in the operations of the County, then County will have the right, in the exercise of its sole and absolute discretion, to proceed with correction or replacement of the Defective Work without prior notice to Contractor, but in such cases will attempt to notify Contractor as soon as possible of the conditions encountered and the action taken by County. Such action by County without prior notice to Contractor shall not relieve Contractor of its responsibility for the costs of such County action or for any Loss occasioned by the Defective Work or necessitated by the County's action, whether such Loss occurs before or after such County action is implemented or completed.

**13.3.4 Correction by County.** If Contractor fails to perform any of its obligations under Paragraph 13.3.2, above, to correct, repair, replace, remove or restore then County, or Separate Contractors under the County's direction, may, notwithstanding any other provisions of this Article 13, proceed to do so and all costs associated therewith (including, without limitation, the cost to store any materials removed) shall be the responsibility of and paid by Contractor at Contractor's Own Expense. Such action by County will not relieve Contractor of the guarantees provided in this Article 13 or elsewhere in the Contract Documents. In addition to Contractor's other obligations under Paragraph 13.3.2, above, Contractor shall correct, repair, replace, remove and restore, to the County's satisfaction and at Contractor's Own Expense any other parts of the Work and any other real or personal property that are damaged or destroyed as a result of such actions by County or the Separate Contractors.

**13.3.5 Sale.** If Contractor does not pay the costs of, or any of the Losses associated with, the correction, repair, replacement, removal or restoration required by the provisions of Paragraph 13.3.2 through Paragraph 13.3.4, above, then within five (5) Days after notice by the County, County may sell any materials or other items of Work removed at auction or at private sale or otherwise dispose of such materials or items and shall account for the net proceeds thereof, after deducting all such costs and Losses, and all costs of sale. If such net proceeds of sale do not cover the Losses for which Contractor is liable to the County, the County may at its option reduce the Contract Price or any payments due to Contractor by such deficiency or recover such deficiency from Contractor.

**13.3.6 No Limitation.** Contractor's obligations under this Article 13 are in addition to, and not in limitation of, its warranty obligations under Section 3.5, above, and any other obligation, guaranty or warranty of Contractor or any other third party under the Contract Documents. Nothing contained in this Article 13 shall be construed to shorten any periods of limitation with respect to other obligations of Contractor under the Contract Documents that are for longer specified periods. Establishment of the Guarantee To Repair Period in no way limits either Contractor's liability for Defective Work or the time within which proceedings may be commenced to enforce Contractor's obligations under the Contract Documents.

#### 13.4 ACCEPTANCE OF NONCONFORMING WORK

Notwithstanding any other provisions of the Contract Documents to the contrary, the County shall have the option, exercised in its sole and absolute discretion after notice to Contractor, in lieu of requiring that Defective Work be remedied or corrected, to reduce the Contract Price to reflect the reduced value of the performance received by County. Such option shall be exercised solely by written notice to Contractor and shall not be implied from any act or omission by County. If there are no remaining payments of the Contract Price to be made to Contractor, or if the remaining payments and retention are insufficient to cover the amount of the reduction of the Contract Price, Contractor shall promptly pay to County the amount of any such deficiency.

### ARTICLE 14 MISCELLANEOUS PROVISIONS

#### 14.1 GOVERNING LAW

The interpretation and enforcement of the Construction Contract and other Contract Documents and of the performance by the parties thereunder shall, notwithstanding application of the principles of conflicts of laws, be governed by the laws of the State of California. The Superior Court for the County of Riverside shall have exclusive jurisdiction and venue over any legal proceedings arising out of or involving the interpretation or enforcement of, or other matters relating to, the Construction Contract, the other Contract Documents or the performance of the parties thereunder.

#### 14.2 TIME OF ESSENCE

All time limits stated in the Contract Documents relative to Contractor's performance of its obligations under the Contract Documents are of the essence.

#### 14.3 SUCCESSORS AND ASSIGNS

The Construction Contract and other Contract Documents shall be binding on successors, assigns and legal representatives of County and Contractor, respectively. Contractor shall not assign, sublet or transfer an interest in or claim under this Construction Contract without advance written approval of County, which approval may be granted or withheld by County in its sole and absolute discretion, and any assignment, subletting or transfer without written approval by County shall be deemed void from its inception. Any assignment, subletting or transfer, whether or not approved by County, will not release Contractor from any of its obligations under the Contract Documents to County. County shall have the right to assign, sublet or transfer its interest in or any claim under the Construction Contract upon written notice to Contractor.

#### 14.4 WRITTEN NOTICE

Any notice from one party to the other or otherwise under the Contract Documents shall be in writing and shall be dated and signed by the party giving such notice or by a duly authorized representative of such party. Any such notice shall be deemed to have been duly served if served in the following manner and in accordance with Civil Code §8100 et seq.:

14.4.1 **Notice to County.** If notice is given to County: (1) by personal delivery thereof to County; or (2) by depositing same in United States mail, enclosed in a sealed envelope addressed to County at Economic Development Agency, Riverside Centre, 3403 Tenth Street, 4th Floor, Riverside, CA 92501, and to such other address as set forth in the Bidding Documents as the location for submission of Bids and sent by registered or certified mail with postage prepaid, or express mail or overnight delivery by an express mail carrier; or (3) by leaving the notice and mailing a copy in the manner provided in Code of Civil Procedure §415.20.

14.4.2 **Notice to Contractor.** If notice is given to Contractor: (1) by personal delivery thereof to Contractor; or (2) by depositing same in United States mails, enclosed in a sealed envelope addressed to Contractor at its address stated in the Construction Contract, or if none is so stated at the address on the records of the Contractor's State License Board and sent by registered or certified mail with postage prepaid or express mail or

overnight delivery by an express mail carrier; or (3) by leaving the notice and mailing a copy in the manner provided in Code of Civil Procedure §415.20.

**14.4.3 Notice to Claimant.** If notice is given to a claimant as defined in Civil Code §8004: (1) by personal delivery thereof to claimant; or (2) by depositing same in United States mail, enclosed in a sealed envelope addressed to claimant at its address stated in: a preliminary notice, stop payment notice, or claim against a payment bond; or on the records of the Contractor's State License Board; and sent by registered or certified mail with postage prepaid or express mail or overnight delivery by an express mail carrier; or (3) by leaving the notice and mailing a copy in the manner provided in code of Civil Procedure §415.20.

**14.4.4 Notice to Surety.** If notice is given to the Surety: (1) by personal delivery to the Surety; or (2) by depositing same in United States mail, enclosed in a sealed envelope, addressed to the Surety at the address of the Surety shown in the applicable Performance Bond or Payment Bond, or if none is shown, the address on the records of the Department of Insurance, and sent by registered or certified mail with postage prepaid or express mail or overnight delivery by an express mail carrier; or (3) by leaving the notice and mailing a copy in the manner provided in Code of Civil Procedure §415.20.

## **14.5 RIGHTS AND REMEDIES**

**14.5.1 County Rights.** Rights and remedies available to the County under the Contract Documents are in addition to and not a limitation of County's rights and remedies otherwise available under other provisions of the Contract Documents or Applicable Laws.

**14.5.2 Writing Required.** Provisions of the Contract Documents may be waived by County only in writing signed by the Director stating expressly that it is intended as a waiver of specified provisions of the Contract Documents.

**14.5.3 Subsequent Breach.** A waiver by either party of any breach of any term, covenant, or condition contained in the Contract Documents shall not be deemed to be a waiver of any subsequent breach of the same or any other term, covenant, or condition contained therein whether of the same or a different character.

## **14.6 NO NUISANCE**

Contractor shall not maintain, commit or permit the maintenance or commission of any nuisance in connection with the performance of Work.

## **14.7 EXTENT OF AGREEMENT**

The Contract Documents represent the full and complete understanding of every kind or nature between the parties and all preliminary negotiations and prior representations, proposals and contracts, of whatever kind or nature, are merged herein and superseded hereby. No verbal agreement or implied covenant shall be held to vary the provisions of the Contract Documents. Any modification of this Construction Contract or the other Contract Documents will be effective only by written instrument signed by both County and Contractor and shall, if required by Applicable Laws, be formally approved or ratified by the Board of Supervisors.

## **14.8 NO THIRD-PARTY RIGHTS**

Nothing contained in the Construction Contract or the other Contract Documents is intended to make any person or entity who is not a signatory to this Construction Contract a third-party beneficiary of any right of Contractor (including, without limitation, any right of Contractor to a benefit derived from, or to the enforcement of, an obligation assumed by County) that is expressly or impliedly created by the terms of the Contract Documents or by operation of Applicable Laws.

#### 14.9 SEVERABILITY

Should any part, term, portion or provision of the Construction Contract or the other Contract Documents, or the application thereof to any party or circumstance, be held to be illegal, invalid or in conflict with Applicable Laws, or otherwise be rendered unenforceable or ineffectual, the validity of the remaining parts, terms, portions or provisions, or the application thereof to any other party or circumstances, shall be deemed severable and the same shall remain enforceable and valid to the fullest extent permitted by Applicable Laws.

#### 14.10 PROVISIONS REQUIRED BY APPLICABLE LAWS

Each and every provision of law and clause required by Applicable Laws to be inserted in the Construction Contract or other Contract Documents shall be deemed to be inserted in the Contract Documents shall be read and enforced as though it were included herein, and if through mistake or otherwise any such provision is not inserted or if inserted and requires correction, then upon request of either party these General Conditions shall forthwith be amended by the parties to the Construction Contract to make such insertion or correction.

#### 14.11 SURVIVAL

All provisions of the Contract Documents that either expressly, or by their nature, require performance or assumption by Contractor of an obligation that extends beyond termination of the Construction Contract or Final Completion of the Work, including, without limitation, Contractor's obligations of, or relating to, indemnification, insurance, ownership of documents, retention and audit of books and records, warranties and guaranties and resolution of Claims shall be deemed to survive either termination of the Construction Contract or Final Completion of the Work.

#### 14.12 FEDERAL GRANTS

In the event of a federal grant or other federal financing participation in the funding of the Project, Contractor shall, as required in connection with, or as a condition to, such federal grant or other federal financing participation, permit access to and grant the right to examine its books covering its services performed and expenses incurred under the Construction Contract or other Contract Documents by the federal agency and comply with all applicable federal agency requirements including, without limitation, those pertaining to work hours, overtime compensation, non-discrimination, and contingent fees.

#### 14.13 PROHIBITED INTERESTS

Contractor agrees not to accept any employment or representation which will, or is likely to, make Contractor "financially interested" (as provided in California Government Code §§1090 and 87100, hereinafter "financially interested") in any decision made by County on any matter in connection with which Contractor has been retained in connection with the Project. Without limitation to the foregoing, transactions and interests prohibited by this Section 14.13 include the following: (1) no official or employee of County who is authorized in such capacity and on behalf of County to negotiate, make, accept, or approve, or to take part in negotiating, making, accepting or approving any architectural, engineering, inspection, construction or material supply contract or any subcontract in connection with construction of the Project, shall become directly or indirectly financially interested in the performance of the Construction Contract or in any part thereof; (2) no officer, employee, architect, attorney, engineer or inspector of or for County who is authorized in such capacity and on behalf of County to exercise any executive, supervisory or other similar functions in connection with Construction Contract or in any part thereof; and (3) Contractor shall receive no compensation hereunder, and shall repay County for any compensation received by Contractor hereunder, should Contractor or any of the Subcontractors aid, abet or knowingly participate in violation of this Section 14.13.

#### 14.14 ASSIGNMENT OF ANTI-TRUST ACTIONS

California Public Contract Code §7103.5(b), which is hereby incorporated by this reference, provides:

"In entering into a public works contract or a subcontract to supply goods, services, or materials pursuant to a public works contract, contractor or the subcontractor offers and agrees to assign to the awarding body all rights, title, and interest in and to all causes of action it may have under Section 4 of the Clayton Act, (15 U.S.C. Sec. 15) or under the

Cartwright Act (Chapter 2 (commencing with Section 16700) of Part 2 of Division 7 of the Business and Professions Code), arising from purchases of goods, services, or materials pursuant to the public works contract or the subcontract. This assignment shall be made and become effective at the time the awarding body tenders final payment to Contractor, without further acknowledgement by the parties."

Contractor for itself and all the Subcontractors agrees to assign to County all rights, title and interest in and to all such causes of action Contractor and all the Subcontractors may have in connection with purchases related to or under the Contract Documents. This assignment shall become effective at the time County tenders Final Payment to Contractor, and Contractor shall require assignments from all the Subcontractors to comply herewith.

#### 14.15 NO WAIVER

County's approval, acceptance, use or payment for any or part of Contractor's performance of the Work shall not in any way alter Contractor's obligations, or waive any of County's rights, under Contract Documents.

#### 14.16 CONSENT TO PHOTOGRAPHING

Contractor is advised that County intends, from time to time, to take photographs, videotapes and/or motion pictures of the Work, and workers located on the Site and proximate settings. Contractor consents to the use of Contractor's name and likeness in instructional or training uses, news releases, advertising and/or publicity throughout the world in perpetuity, in all media now known or hereafter invented. Contractor shall include in its contracts with its Subcontractors a consent by the Subcontractor to the use of Subcontractor's name and the likenesses of its employees on the same terms as provided for herein applicable to such consent by Contractor.

### ARTICLE 15 DEFAULT, TERMINATION AND SUSPENSION

#### 15.1 COUNTY REMEDIES FOR DEFAULT

15.1.1 **Event of Default.** Each and any of the following shall be considered an Event of Contractor Default:

- .1 Contractor files a petition, or has filed against it a petition, for bankruptcy or is adjudged bankrupt;
- .2 Contractor makes a general assignment for the benefit of its creditors;
- .3 a receiver is appointed on account of Contractor's insolvency;

.4 Contractor defaults, by failing or refusing to perform any obligation set forth in the EZIQC Contract, General Conditions, Work Order(s), or elsewhere in the Contract Documents (including, without limitation, the performance or installation of Defective Work) and thereafter: (1) fails to commence to cure such default within two (2) working days after receipt of written notice of default; (2) if the default can be cured within three (3) Days, Contractor fails or refuses after commencing to cure in accordance with Clause (1) hereof to fully cure such default within three (3) Days after receipt of written notice of default; or (3) if the default cannot be fully cured within three (3) Days, Contractor fails after commencing to cure in accordance with Clause (1) hereof to diligently and continuously prosecute and fully cure such default within ten (10) Days after receipt of such written notice;

.5 Contractor fails or refuses to perform an obligation set forth in the EZIQC Contract, General Conditions, Supplemental General Conditions, Work Order(s), or other Contract Documents that either (1) cannot be cured, or (2) cannot be cured within the 10-Day cure period set forth in Subparagraph 15.1.1.4, above;

.6 Specifically, if the Contractor refuses or fails to:

- (a) accept a Work Order or any part of a Work Order as directed by the County;



- (b) respond to a joint scope invitation as issued by the County Project Manager;
- (c) develop Proposal(s) properly and timely in substantial compliance with an RFP issued by the County Project Manager;
- (d) reach agreement with the County on the means, methods, and quantities to accomplish a specific scope of Work;
- (e) commence the Work within the time specified in the Work schedule;
- (f) prosecute the Work or any separable part with due diligence to ensure completion in accordance with the Work schedule, including any extensions or adjustments made thereto;
- (g) provide sufficient and properly skilled workmen or proper materials or equipment to complete the Work in a workmanlike manner and without

**.7** a breach of any other agreement between County and Contractor as provided in Paragraph 15.1.9, below.

**15.1.2 County's Remedies.** Without limitation to the County's other rights or remedies under the Contract Documents or Applicable Laws, if there is an Event of Contractor Default, County shall have the right to exercise any one or more of the following remedies:

**.1 Take Over Work.** County may, without terminating the EZIQC Contract and without incurring any additional liability or responsibility to Contractor (including, without limitation, any obligation to agree to a Contract Adjustment for any portion of the taken-over or non-taken-over Work), take over and perform, or engage others to perform, all or a portion of the Work.

**.2 Suspend Work.** County may, without terminating the EZIQC Contract and without incurring any additional liability or responsibility to Contractor (including, without limitation, any obligation to agree to a Contract Adjustment for any portion of the suspended or non-suspended Work), suspend Contractor's performance of all or a portion of the Work for as long a period of time as the County determines, in its sole discretion, is appropriate.

**.3 Termination.** County may, without incurring any additional liability or responsibility to Contractor, terminate the EZIQC Contract, the Work or any portion thereof.

**.4 Surety.** If there is an Event of Contractor Default pursuant to any of Subparagraphs 15.1.1.1 through 15.1.1.5, above, County may, with or without terminating the EZIQC Contract and without incurring any additional liability or responsibility to Contractor or Surety (including, without limitation, any obligation to agree to a Contract Adjustment), exercise its rights under the Performance Bond furnished by Contractor by giving Surety ten (10) Days' written notice of demand to perform; provided, however, that if the Surety fails, within seven (7) Days after receipt by Surety of written demand, to deliver to the County written notice of its unconditional intention to perform or does not commence performance of the Work within ten (10) Days from receipt of such notice of demand, the County may, at Contractor's Own Expense and/or the expense of the Surety, and with or without terminating the EZIQC Contract, proceed to complete the Work by any other means County deems expedient. By executing its Performance Bond incorporating the terms of the Construction Contract, Surety shall be deemed to have agreed, without limitation, to the provisions of this Paragraph 15.1.2 as constituting a binding obligation of Surety under its Performance Bond that shall control over any conflicting provisions set forth in the Performance Bond. Neither delivery by Surety of such written notice of unconditional intention to perform nor its timely performance of the Work in accordance with the terms of the Contract Documents and Performance Bond shall constitute waiver by Surety of any rights it may have under the Performance Bond and Applicable Laws to limit its liability to the penal amount of the Performance Bond.

**15.1.3 Contractor Tools, Equipment.** Upon County's exercise of one or more of its remedies following an Event of Contractor Default, County shall have the right, but not the obligation, to perform or complete all or any portion of the Work using any means that County may deem expedient, including, without limitation, taking possession and utilization of any or all of the materials, equipment, appliances, tools, plant and other property not owned by Contractor that are on the Site for County's use in performing the Work.

**15.1.4 Contractor Obligations.** Upon exercise by County of its remedies following an Event of Contractor Default, Contractor shall, unless County directs in writing otherwise, do the following:

- .1 immediately discontinue performance of the Work to the extent specified in writing by County;
- .2 remove no materials, equipment or tools (other than those owned by Contractor and not necessary for performance of a portion of the Work not terminated or discontinued) from the Site unless directed to do so by County and take all actions necessary or appropriate, or that the County may direct in writing, for the protection and preservation of the Work, any materials, equipment or tools at the Site and any materials or equipment in transit to the Site;
- .3 place no further orders or subcontracts for materials, equipment, services or facilities, except as may be necessary for Contractor to continue performance of such portion, if any, of the Work that is not discontinued or terminated by County in its written notice;
- .4 provide to the County, in writing, no later than two (2) Days after request by County, a statement listing or providing: (1) all subcontract agreements, purchase orders and contracts that are outstanding, as well as any change orders, amendments and modifications thereto; (2) the status of invoicing, payments and balance owing under each such subcontract agreement, purchase order and contract; (3) the status of performance and any claims asserted under each such subcontract agreement, purchase order and contract; and (4) providing such other information as the County may determine to be necessary in order to decide whether to accept assignment of any such subcontract agreement, purchase order or contract;
- .5 promptly following and in accordance with County's written direction: (1) assign to the County or its designee those subcontract agreements, purchase orders or contracts, or portions thereof, that the County elects in writing to accept by assignment; (2) cancel, on the most favorable terms reasonably possible, any subcontract agreement, purchase order or contract, or portion thereof, that the County does not elect to accept by assignment; and (3) if requested by County, settle, with the prior written approval of County of the terms of settlement, outstanding liabilities to Subcontractors with respect to the Work terminated or discontinued;
6. not terminate any insurance required by the Contract Documents;
7. thereafter continue only such performance as may be directed by County;
8. deliver to the County the documents required to delivered pursuant to Paragraph 1.3.6, above; and
9. at the written request and option of County, exercised in its sole discretion, deliver to the County, and transfer title to the County of, any completed items, materials, products, equipment or other unincorporated parts of the Work that have not been previously delivered to the Site.

#### **15.1.5 Accounting and Payment**

##### **.1 Full Termination or Discontinuance.**

**(1) Further Payment.** In the event an exercise by County of any of its remedies following an Event of Contractor Default results in a termination or discontinuance of the entire Work, then no further payment shall be due to Contractor for the Work until an accounting has been conducted in accordance with this Paragraph 15.1.5.

**(2) Time for Accounting.** Within forty-five (45) Days after Final Completion of the Work by Contractor, Surety, County or others at request of County, an accounting shall be made pursuant to this Paragraph 15.1.5 of the amount due to Contractor or County.

**(3) Payment Amount.** If, based on the accounting conducted pursuant to this Paragraph 15.1.5, the Contractor Amount exceeds the County Amount, then the difference shall be paid by County to

Contractor within fifteen (15) Days after demand by Contractor following completion of such accounting. If the County Amount exceeds the Contractor Amount, then the difference shall be paid by Contractor to County within fifteen (15) Days after demand by County following completion of such accounting. Payment by Contractor of the amount due to County pursuant to such accounting shall not be construed as a release of Contractor's obligation to County for, or County's right to recover from Contractor, any Losses, of any kind whatsoever, not part of the calculation of the County Amount (including, without limitation, additional Losses related to circumstances that formed the basis for calculation of the County Amount) that may be then or thereafter owing to or recoverable by County under Applicable Laws or the Contract Documents.

**(4) Contractor Amount.** The Contractor Amount used as the basis for payment pursuant to the accounting under this Paragraph 15.1.5 shall be calculated as follows:

**(a)** take a portion of the Contract Price determined by multiplying (i) the Contract Price, by (ii) the County's Good Faith Determination of the percentage of the Work properly performed by Contractor and (A) in permanent place, (B) previously fabricated and delivered to the Site or (C) fabricated and en route for delivery to the Site and delivered to the Site within a reasonable time after Contractor's receipt of such written notice; and

**(b)** subtract therefrom all amounts previously paid by County to Contractor or to Subcontractors.

**(5) County Amount.** The County Amount used as the basis for payment pursuant to the accounting under this Paragraph 15.1.5 shall be calculated based on the sum of all past, present and future Losses to County resulting or reasonably certain to result, directly or indirectly, from any or all of the following: (a) any negligence, willful misconduct, or Defective Work on the part of Contractor or any Subcontractor; (b) any Event of Contractor Default, whether or not constituting the basis of the County's termination or discontinuance; (c) the County's exercise of its rights and remedies under and in accordance with the Contract Documents or Applicable Laws following the occurrence of an Event of Contractor Default; and (d) the payment by County of amounts to Contractor or any Subcontractor that were not owing to Contractor or that were in excess of the amount to which Contractor was entitled under the Contract Documents.

**.2 Partial Termination or Discontinuance.** In the event an exercise by County of its remedies for an Event of Contractor Default results in a discontinuance or termination of only a portion of the Work, then the Contract Price and Contract Time shall be adjusted under the provisions of Article 7 and Article 8, above, applicable to Deleted Work. Contractor shall thereafter continue to be paid for its performance of the other portions of the Work in accordance with the terms of the Contract Documents, less any amounts that County is entitled to withhold under the terms of the Contract Documents.

**.3 Exclusive Compensation.** Contractor agrees to accept such amounts, if any, as allowed under this Paragraph 15.1.5 as its sole and exclusive compensation in the event of an exercise by County of its remedies permitted by the Contract Documents or Applicable Laws following an Event of Contractor Default.

**15.1.6 Surety.** Without limitation to any of the County's other rights or remedies under a Performance Bond furnished by Contractor, Contract Documents or Applicable Laws, the County has the right to suspend, take over or terminate the performance of the Work by Surety in the event of any of the following: (1) failure of Surety or its contractors to begin the Work within a reasonable time in such manner as to ensure full compliance with the Contract Documents within the Contract Time; (2) abandonment of the Work by Surety or its contractors; (3) if at any time the County makes a Good Faith Determination that the Work is unnecessarily or unreasonably delayed by Surety or its contractors; (4) violation by Surety or its contractors of any terms of the Contract Documents, Performance Bond or Applicable Laws; or (5) failure by Surety or its contractors to follow instructions of the County for performance of the Work or for performance of the Work within the Contract Time. By executing its Performance Bond incorporating the terms of the Construction Contract, Surety shall be deemed to have agreed, without limitation, to the provisions of this Paragraph 15.1.6 as constituting a binding obligation of Surety under its Performance Bond that shall control over any conflicting provisions set forth in the Performance Bond.

**15.1.7 Conversion.** In the event a termination for cause by the County is adjudged by a court or by binding arbitration conducted in accordance with the Contract Documents to have been wrongful, such termination

shall be deemed converted to a termination for convenience pursuant to Section 15.3, below, in which case Contractor agrees to accept such amount, if any, as permitted by Paragraph 15.3.3, below, as its sole and exclusive compensation and agrees to waive any right to recovery of any other compensation or Loss, including, but not limited to, loss of anticipated profits, loss of revenue, lost opportunity or other consequential, direct, indirect or incidental damages, of any kind.

**15.1.8 Substantial Performance Waived.** The legal doctrine that a contractor may recover for substantial performance of a building contract is to have no application to the Construction Contract. Any Event of Contractor Default, whether occurring before or after the Work is Substantially Completed, shall be deemed material and shall give rise to the right of County to exercise its remedies permitted under the Contract Documents or Applicable Laws.

**15.1.9 Cross Default.** Contractor agrees that a breach of any other agreement between Contractor and County, whether related or unrelated to the Project, that is not cured in accordance with the terms of such other agreement constitutes an Event of Contractor Default under the EZIQC Contract, thereby entitling County to assert all its rights and remedies hereunder including, but not limited to, a specific right of off set by County against any amounts otherwise payable to Contractor under the EZIQC Contract or any other agreement between Contractor and County.

**15.1.10 Rights Cumulative.** All of County's rights and remedies under the Contract Documents are cumulative, and shall be in addition to and not a limitation upon those rights and remedies available under Applicable Laws.

**15.1.11 Materiality.** Designation in the Contract Documents of certain defaults as "material" shall not be construed as implying that other defaults not so designated are not material nor as limiting County's right to terminate or exercise its other rights or remedies for default to only material defaults.

**15.1.12 County Action.** No termination or action taken by County after termination shall prejudice any rights or remedies of County provided by Applicable Laws or by the Contract Documents, including, without limitation, the right of County to proceed against Contractor to recover all Losses suffered by reason of Contractor's default.

## **15.2 SUSPENSION BY COUNTY FOR CONVENIENCE**

**15.2.1 Suspension Order.** Without limitation to the County's rights under Section 15.1, above, County may, at any time, for its convenience and without the occurrence of any Event of Contractor Default, order Contractor, in writing, to suspend, delay or interrupt performance of the Work, in whole or in part. Upon receipt of such an order, Contractor shall comply with its terms and take all reasonable steps to minimize additional costs that are incurred applicable to the portion of the Work suspended, delayed or interrupted by County.

**15.2.2 Resumption.** If an order issued by the County pursuant to this Section 15.2 is canceled or expires, Contractor shall resume and continue with the previously affected portion of the Work. In such event, Contractor shall be entitled to a Contract Adjustment for additional Allowable Costs necessarily caused by such order and compensation allowed under Section 3.3 of the Construction Contract for Compensable Delay; provided, however, that no such Contract Adjustment shall be made: (1) to the extent that performance either is, was or would have been so suspended, delayed or interrupted by another cause for which Contractor or any of the Subcontractors is responsible or for which Contractor would not be entitled to a Contract Adjustment; (2) to the extent that a Contract Adjustment on account thereof is made or denied under another provision of the Contract Documents; or (3) for any general or specific escalation in prices of the Work.

**15.2.3 Limitation.** The provisions of this Section 15.2 shall not apply unless a written order is issued by County pursuant to this Section 15.2.

## **15.3 TERMINATION BY COUNTY FOR CONVENIENCE**

**15.3.1 Right to Terminate for Convenience.** Without limitation upon any of County's other rights or remedies under the Contract Documents or Applicable Laws, County shall have the option, at its sole discretion

and without the occurrence of any Event of Contractor Default or any other cause, to terminate the Construction Contract or Work, in whole or in part, for its convenience by giving five (5) Days written notice to Contractor.

**15.3.2 Contractor Obligations.** Upon receipt of notice of termination for convenience pursuant to this Section 15.3, Contractor shall, unless such notice directs otherwise, comply with all of the provisions of Paragraph 15.1.4, above.

**15.3.3 Contractor Compensation.** Following a termination for convenience pursuant to this Section 15.3 and within sixty (60) Days after receipt of a complete and timely Application for Payment from Contractor, an accounting shall be conducted in accordance with the process set forth in Paragraph 15.1.5, above. In such event, the amount due to Contractor shall be the Contractor Amount as calculated in the same manner provided for in Paragraph 15.1.5, above, except that there shall be added to the calculation of the Contractor Amount an amount for: (1) the reasonable, actual and direct Allowable Costs incurred and paid by Contractor (and not by Subcontractors) for (a) demobilizing Contractor's facilities from the Site, and (b) Contractor's administering the close out of its participation in the Project for a period of no longer than fifteen (15) Days; plus (2) a markup to Contractor on the Contractor's Allowable Costs incurred under Clause (1) of this Paragraph 15.3.4 that is based on the percentage for Allowable Markup that Contractor is permitted to charge pursuant to Article 7, above, for Compensable Changes involving Extra Work that is Self-Performed Work.

**15.3.4 Exclusive Compensation.** Contractor agrees to accept the compensation allowed under Paragraph 15.3.3, above, as its sole and exclusive compensation in the event of a termination by County for convenience and waives any claim for Loss related to County's termination for convenience, including, but not limited to, loss of anticipated profits, loss of revenue, lost opportunity, or other consequential, direct, indirect, or incidental damages, of any kind.

**15.3.5 Subcontractors.** Contractor shall include provisions in all of its subcontracts, purchase orders and other contracts with the Subcontractors permitting termination for convenience by Contractor on terms that are consistent with, and that afford no greater rights of recovery against Contractor for termination than are afforded to Contractor under, this Section 15.3.

## 15.4 TERMINATION BY CONTRACTOR

**15.4.1 Contractor's Remedies.** Subject to the provisions of Paragraph 15.4.2, below and Paragraph 15.4.3, below, Contractor's sole right to terminate the Construction Contract shall be its right to terminate, for cause only, upon the occurrence of either of the following:

.1 the entire Work is stopped for one hundred sixty (160) consecutive Days, through no act or fault of Contractor or any of the Subcontractors, of any Tier, or any employee or agent of any of them, due to issuance of an order of a court or other Governmental Authority or due to a declaration of a national emergency making material unavailable; or

.2 the entire Work is suspended by Contractor, in accordance with a proper exercise by Contractor of its rights under Section 9.8, above, for a continuous period of thirty (30) Days.

**15.4.2 Notice of Intention to Terminate.** If one of the reasons to terminate as described in Paragraph 15.4.1, above, exists, Contractor may, upon thirty (30) Days written notice to County, terminate the Construction Contract and recover from County as its sole and exclusive compensation such sums as are permitted under Paragraph 15.3.3, above.

**15.4.3 Continuous Performance.** Provided that Contractor is paid undisputed sums due in accordance with the requirements of the Construction Contract, Contractor shall not stop, delay or interrupt continuous performance of the Work by reason of any dispute or disagreement with County, including, without limitation, any disputes or disagreements over payments of money claimed due under the Contract Documents.

## 15.5 WARRANTIES

All obligations of Contractor and the Subcontractors under the Contract Documents with respect to warranties and guarantees of the Work will continue in force and shall apply, notwithstanding a termination or other discontinuance of the Work by County or Contractor pursuant to an exercise of rights by either under this Article 15, to any portion of the Work that at the time of such termination or discontinuance has been completed or partially completed by Contractor to the point that it is substantially ready (exclusive of any incidental work that may be needed to connect such portion to other Work to other Work or Existing Improvements or to energize such portion of the Work for operation) for use or occupancy by County.

## ARTICLE 16 NON-DISCRIMINATION

### 16.1 NON-DISCRIMINATION IN SERVICES

**16.1.1** Contractor must, in accordance with Applicable Laws, not discriminate in the provision of services hereunder because of race, color, religion, national origin, ancestry, sex, age, sexual orientation, marital status, AIDS or disability. For the purpose of this Section 16.1, discrimination in the provision of services may include, but is not limited to the following:

- .1 denying any person any service or benefit or the availability of a facility;
- .2 providing any service or benefit to any person which is not equivalent to, or is in a non-equivalent manner or at a non-equivalent time from, that provided to others;
- .3 subjecting any person to segregation or separate treatment in any manner related to the receipt of any service;
- .4 restricting any person in any way in the enjoyment of any advantage or privilege enjoyed by others receiving any service or benefit; or
- .5 treating any person differently from others in determining admission, enrollment, eligibility, membership, or any other requirement or condition which persons must meet in order to be provided any service or benefit.

**16.1.2** Contractor shall ensure that services are provided without regard to race, color, religion, national origin, ancestry, sex, age, sexual orientation, marital status, AIDS or disability.

**16.1.3** Contractor shall establish and maintain written procedures under which any person applying for, performing or receiving services hereunder, may seek resolution from Contractor of a complaint with respect to any alleged discrimination. Such persons shall be advised by Contractor of these procedures. A copy of such procedures shall be posted by Contractor in a conspicuous place, available and open to the public, in each of Contractor's facilities where services are provided hereunder.

### 16.2 NON-DISCRIMINATION IN EMPLOYMENT

Contractor must, in accordance with Applicable Laws, not discriminate against any employee or applicant for employment because of race, color, religion, national origin, ancestry, sex, age, sexual orientation, marital status, AIDS or disability. Without limitation to any other provisions of this Section 16.2, in the performance of the obligations under the Contract Documents, Contractor and the Subcontractors shall comply with all applicable provisions of the California Fair Employment Practices Act (California Government Code §§12940-48) and the applicable equal employment provisions of the Civil Rights Act of 1964 (42 U.S.C. §§200e - 217), whichever is more restrictive. Contractor and the Subcontractors shall ensure that qualified applicants are employed and that employees are treated during employment without regard to race, color, religion, national origin, ancestry, sex, age, sexual orientation, marital status, AIDS or disability, in accordance with requirements of Applicable Laws. Such shall include, but not be limited to, the following:

.1 employment, promotion, demotion, transfer, recruitment or recruitment advertising, layoff or termination, rates of pay or other forms of compensation; or

.2 selection for training, including apprenticeship.

**16.2.1** Contractor agrees to post in conspicuous places in each of Contractor's facilities providing services hereunder, available and open to employees and applicants for employment, notices setting forth the provisions of this Section 16.2.

**16.2.2** Contractor shall, in all solicitations or advertisements for employees placed by or on behalf of Contractor, state that all qualified applicants will receive consideration for employment without regard to race, color, religion, national origin, ancestry, sex, age, sexual orientation, marital status, AIDS or disability, in accordance with requirements of Applicable Laws.

**16.2.3** Contractor shall send to each labor union, or workers' representative with which it has a collective bargaining agreement or other contract or understanding, a notice advising the labor union or the workers' representative of Contractor's commitments under this Section 16.2.

**16.2.4** Contractor certifies and agrees that it will deal with the Subcontractors, bidders and vendors without regard to race, color, religion, national origin, ancestry, sex, age, sexual orientation, marital status, AIDS or disability, in accordance with the requirements of Applicable Laws.

**16.2.5** In accordance with Applicable Laws, Contractor shall allow duly authorized representatives of the County, State, and Federal government access to its employment records during regular business hours in order to verify compliance with the provisions of this Section 16.2. Contractor shall provide such other information and records as such representatives may require in order to verify compliance with the provisions of this Section 16.2.

**16.2.6** If County finds that any of the provisions of this Section 16.2 have been violated by Contractor or any of the Subcontractors, such violation shall constitute a material breach of the Construction Contract for which County may cancel, terminate or suspend the Construction Contract. While County reserves the right to determine independently that the anti-discrimination provisions of the Construction Contract have been violated, a determination by the California Fair Employment and Housing Commission or the Federal Equal Employment Opportunity Commission that Contractor or the Subcontractor has violated State or Federal anti-discrimination laws shall constitute a finding by County that Contractor or the Subcontractor has violated the provisions of this Section 16.2.

**16.2.7** Contractor hereby agrees that it will comply with §504 of the Rehabilitation Act of 1973, as amended (29 U.S.C. §794) and similar Applicable Laws relating to employment of or access to persons with disabilities, all requirements imposed by applicable Federal Regulations, and all guidelines and interpretations issued pursuant thereto, to the end that no qualified disabled person shall, on the basis of disability, be excluded from participation in, be denied the benefits of, or otherwise be subjected to discrimination under any program or activity of Contractor receiving Federal Financial Assistance.

**END OF GENERAL CONDITIONS**

# COUNTY OF RIVERSIDE RCIT RC3 FACILITY DISTRIBUTION SYSTEM RENOVATION

1960 F CHICAGO AVE.  
RIVERSIDE, CA 92507

VICINITY MAP



NOTES

**CODE REQUIREMENTS**

APPLICABLE CODES AND REGULATIONS:

1. ALL ELECTRICAL WORK SHALL BE PERFORMED IN ACCORDANCE WITH THE CALIFORNIA ELECTRICAL CODE (CEC) AND THE CALIFORNIA MECHANICAL CODE (CMC) AS AMENDED AND THE CITY OF RIVERSIDE ORDINANCES AND REGULATIONS. THE CITY OF RIVERSIDE ORDINANCES AND REGULATIONS ARE INCORPORATED INTO THESE CONTRACT DOCUMENTS BY REFERENCE.

2. TITLE 24, CALIFORNIA STATE FIRE MARSHAL REGULATIONS.

3. TITLE 24, CALIFORNIA CODE OF REGULATIONS.

PART 1-2013 CALIFORNIA STATE FIRE MARSHAL REGULATIONS (BASED ON THE 2006 IBC)

PART 2-2013 CALIFORNIA ELECTRICAL CODE (BASED ON THE 2008 NEC)

PART 3-2013 CALIFORNIA MECHANICAL CODE (BASED ON THE 2006 IMC)

PART 4-2013 CALIFORNIA PLUMBING CODE (BASED ON THE 2006 UPC)

PART 5-2013 CALIFORNIA MECHANICAL CODE (BASED ON THE 2006 IMC)

PART 6-2013 CALIFORNIA MECHANICAL CODE (BASED ON THE 2006 IMC)

PART 7-2013 CALIFORNIA MECHANICAL CODE (BASED ON THE 2006 IMC)

PART 8-2013 CALIFORNIA MECHANICAL CODE (BASED ON THE 2006 IMC)

PART 9-2013 CALIFORNIA MECHANICAL CODE (BASED ON THE 2006 IMC)

PART 10-2013 CALIFORNIA MECHANICAL CODE (BASED ON THE 2006 IMC)

LIFE SAFETY CODE (CALIFORNIA MECHANICAL CODE CHAPTER 110)

ACCESSIBILITY: CALIFORNIA BUILDING CODE CHAPTER 11B

**CONSTRUCTION GENERAL NOTES**

1. ALL WORK SHALL BE PERFORMED IN ACCORDANCE WITH THE CITY OF RIVERSIDE ORDINANCES AND REGULATIONS. THE CITY OF RIVERSIDE ORDINANCES AND REGULATIONS ARE INCORPORATED INTO THESE CONTRACT DOCUMENTS BY REFERENCE.
2. IT IS HEREBY UNDERSTOOD THAT THE WORK SHALL BE PERFORMED IN ACCORDANCE WITH THE CITY OF RIVERSIDE ORDINANCES AND REGULATIONS. THE CITY OF RIVERSIDE ORDINANCES AND REGULATIONS ARE INCORPORATED INTO THESE CONTRACT DOCUMENTS BY REFERENCE.
3. THE CONTRACTOR SHALL BE RESPONSIBLE FOR OBTAINING ALL NECESSARY PERMITS AND APPROVALS FROM THE CITY OF RIVERSIDE. THE CONTRACTOR SHALL BE RESPONSIBLE FOR OBTAINING ALL NECESSARY PERMITS AND APPROVALS FROM THE CITY OF RIVERSIDE.
4. THE CONTRACTOR SHALL BE RESPONSIBLE FOR OBTAINING ALL NECESSARY PERMITS AND APPROVALS FROM THE CITY OF RIVERSIDE. THE CONTRACTOR SHALL BE RESPONSIBLE FOR OBTAINING ALL NECESSARY PERMITS AND APPROVALS FROM THE CITY OF RIVERSIDE.
5. THE CONTRACTOR SHALL BE RESPONSIBLE FOR OBTAINING ALL NECESSARY PERMITS AND APPROVALS FROM THE CITY OF RIVERSIDE. THE CONTRACTOR SHALL BE RESPONSIBLE FOR OBTAINING ALL NECESSARY PERMITS AND APPROVALS FROM THE CITY OF RIVERSIDE.

SHEET INDEX

NO.	DESCRIPTION
T1.00	TITLE SHEET
S1.1	GENERAL NOTES
S1.2	SECTIONS AND DETAILS
P001	PLUMBING GENERAL NOTES, ABUTMENT & FINISHES
P002	PLUMBING DETAILS
P003	PLUMBING SPECIFICATIONS
P004	PLUMBING SITE PLAN
E001	ELECTRICAL GENERAL NOTES
E002	ELECTRICAL FINISHES AND ABUTMENTS
E003	ELECTRICAL SPECIFICATIONS
E004	ELECTRICAL SITE PLAN
E005	ELECTRICAL FINISHES AND ABUTMENTS
E006	ELECTRICAL SPECIFICATIONS
E007	ELECTRICAL SITE PLAN
E008	ELECTRICAL FINISHES AND ABUTMENTS
E009	ELECTRICAL SPECIFICATIONS
E010	ELECTRICAL SITE PLAN
E011	ELECTRICAL FINISHES AND ABUTMENTS
E012	ELECTRICAL SPECIFICATIONS
E013	ELECTRICAL SITE PLAN
E014	ELECTRICAL FINISHES AND ABUTMENTS
E015	ELECTRICAL SPECIFICATIONS
E016	ELECTRICAL SITE PLAN
E017	ELECTRICAL FINISHES AND ABUTMENTS
E018	ELECTRICAL SPECIFICATIONS
E019	ELECTRICAL SITE PLAN
E020	ELECTRICAL FINISHES AND ABUTMENTS
E021	ELECTRICAL SPECIFICATIONS
E022	ELECTRICAL SITE PLAN
E023	ELECTRICAL FINISHES AND ABUTMENTS
E024	ELECTRICAL SPECIFICATIONS
E025	ELECTRICAL SITE PLAN
E026	ELECTRICAL FINISHES AND ABUTMENTS
E027	ELECTRICAL SPECIFICATIONS
E028	ELECTRICAL SITE PLAN
E029	ELECTRICAL FINISHES AND ABUTMENTS
E030	ELECTRICAL SPECIFICATIONS
E031	ELECTRICAL SITE PLAN
E032	ELECTRICAL FINISHES AND ABUTMENTS
E033	ELECTRICAL SPECIFICATIONS
E034	ELECTRICAL SITE PLAN
E035	ELECTRICAL FINISHES AND ABUTMENTS
E036	ELECTRICAL SPECIFICATIONS
E037	ELECTRICAL SITE PLAN
E038	ELECTRICAL FINISHES AND ABUTMENTS
E039	ELECTRICAL SPECIFICATIONS
E040	ELECTRICAL SITE PLAN
E041	ELECTRICAL FINISHES AND ABUTMENTS
E042	ELECTRICAL SPECIFICATIONS
E043	ELECTRICAL SITE PLAN
E044	ELECTRICAL FINISHES AND ABUTMENTS
E045	ELECTRICAL SPECIFICATIONS
E046	ELECTRICAL SITE PLAN
E047	ELECTRICAL FINISHES AND ABUTMENTS
E048	ELECTRICAL SPECIFICATIONS
E049	ELECTRICAL SITE PLAN
E050	ELECTRICAL FINISHES AND ABUTMENTS
E051	ELECTRICAL SPECIFICATIONS
E052	ELECTRICAL SITE PLAN
E053	ELECTRICAL FINISHES AND ABUTMENTS
E054	ELECTRICAL SPECIFICATIONS
E055	ELECTRICAL SITE PLAN
E056	ELECTRICAL FINISHES AND ABUTMENTS
E057	ELECTRICAL SPECIFICATIONS
E058	ELECTRICAL SITE PLAN
E059	ELECTRICAL FINISHES AND ABUTMENTS
E060	ELECTRICAL SPECIFICATIONS
E061	ELECTRICAL SITE PLAN
E062	ELECTRICAL FINISHES AND ABUTMENTS
E063	ELECTRICAL SPECIFICATIONS
E064	ELECTRICAL SITE PLAN
E065	ELECTRICAL FINISHES AND ABUTMENTS
E066	ELECTRICAL SPECIFICATIONS
E067	ELECTRICAL SITE PLAN
E068	ELECTRICAL FINISHES AND ABUTMENTS
E069	ELECTRICAL SPECIFICATIONS
E070	ELECTRICAL SITE PLAN
E071	ELECTRICAL FINISHES AND ABUTMENTS
E072	ELECTRICAL SPECIFICATIONS
E073	ELECTRICAL SITE PLAN
E074	ELECTRICAL FINISHES AND ABUTMENTS
E075	ELECTRICAL SPECIFICATIONS
E076	ELECTRICAL SITE PLAN
E077	ELECTRICAL FINISHES AND ABUTMENTS
E078	ELECTRICAL SPECIFICATIONS
E079	ELECTRICAL SITE PLAN
E080	ELECTRICAL FINISHES AND ABUTMENTS
E081	ELECTRICAL SPECIFICATIONS
E082	ELECTRICAL SITE PLAN
E083	ELECTRICAL FINISHES AND ABUTMENTS
E084	ELECTRICAL SPECIFICATIONS
E085	ELECTRICAL SITE PLAN
E086	ELECTRICAL FINISHES AND ABUTMENTS
E087	ELECTRICAL SPECIFICATIONS
E088	ELECTRICAL SITE PLAN
E089	ELECTRICAL FINISHES AND ABUTMENTS
E090	ELECTRICAL SPECIFICATIONS
E091	ELECTRICAL SITE PLAN
E092	ELECTRICAL FINISHES AND ABUTMENTS
E093	ELECTRICAL SPECIFICATIONS
E094	ELECTRICAL SITE PLAN
E095	ELECTRICAL FINISHES AND ABUTMENTS
E096	ELECTRICAL SPECIFICATIONS
E097	ELECTRICAL SITE PLAN
E098	ELECTRICAL FINISHES AND ABUTMENTS
E099	ELECTRICAL SPECIFICATIONS
E100	ELECTRICAL SITE PLAN

PROJECT DESCRIPTION

UPGRADE FACILITY TO MEET THE REQUIREMENTS FOR A Tier 3 DATA CENTER BY IMPROVING THE DISTRIBUTION SYSTEM AND PROVIDING REDUNDANCY TO THE SYSTEM. THE PROJECT WILL INCLUDE THE FOLLOWING:

- 1. REPAIR AND REPLACE EXISTING ELECTRICAL AND PLUMBING SYSTEMS.
- 2. INSTALL NEW ELECTRICAL AND PLUMBING SYSTEMS.
- 3. PROVIDE REDUNDANCY TO THE SYSTEM.
- 4. PROVIDE 24/7/365 OPERATION.

PROJECT TEAM

**PROJECT ADDRESS**  
COUNTY OF RIVERSIDE - RCIT RC3 FACILITY  
1960 F CHICAGO AVENUE  
RIVERSIDE, CA 92507  
PHONE: 951-945-3700  
EMAIL: PROJECT@RIVERSIDE.CA.GOV

**OWNER**  
COUNTY OF RIVERSIDE - RCIT  
4400 LINDEN STREET  
RIVERSIDE, CA 92501  
PHONE: 951-945-3700  
EMAIL: PROJECT@RIVERSIDE.CA.GOV

**STRUCTURAL ENGINEER**  
THE W.A. PETERSON, INC. 405  
1000 W. 10TH STREET  
RIVERSIDE, CA 92504  
PHONE: 951-945-3700  
EMAIL: PROJECT@RIVERSIDE.CA.GOV

**PLUMBING DESIGNER**  
DGA ENGINEERS  
4250 EAST ORANGE HILLS PARKWAY  
ONTARIO, CA 91764  
PHONE: 951-945-3700  
EMAIL: PROJECT@RIVERSIDE.CA.GOV

**ELECTRICAL ENGINEER**  
DGA ENGINEERS  
4250 EAST ORANGE HILLS PARKWAY  
ONTARIO, CA 91764  
PHONE: 951-945-3700  
EMAIL: PROJECT@RIVERSIDE.CA.GOV

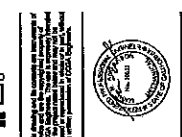
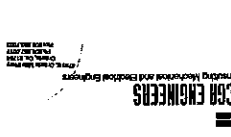

COUNTY OF RIVERSIDE RCIT RC3  
FACILITY DISTRIBUTION SYSTEM RENOVATION  
1960 F CHICAGO AVENUE  
RIVERSIDE, CALIFORNIA 92507

TITLE SHEET

NO.	DESCRIPTION
T1.00	TITLE SHEET
S1.1	GENERAL NOTES
S1.2	SECTIONS AND DETAILS
P001	PLUMBING GENERAL NOTES, ABUTMENT & FINISHES
P002	PLUMBING DETAILS
P003	PLUMBING SPECIFICATIONS
P004	PLUMBING SITE PLAN
E001	ELECTRICAL GENERAL NOTES
E002	ELECTRICAL FINISHES AND ABUTMENTS
E003	ELECTRICAL SPECIFICATIONS
E004	ELECTRICAL SITE PLAN
E005	ELECTRICAL FINISHES AND ABUTMENTS
E006	ELECTRICAL SPECIFICATIONS
E007	ELECTRICAL SITE PLAN
E008	ELECTRICAL FINISHES AND ABUTMENTS
E009	ELECTRICAL SPECIFICATIONS
E010	ELECTRICAL SITE PLAN
E011	ELECTRICAL FINISHES AND ABUTMENTS
E012	ELECTRICAL SPECIFICATIONS
E013	ELECTRICAL SITE PLAN
E014	ELECTRICAL FINISHES AND ABUTMENTS
E015	ELECTRICAL SPECIFICATIONS
E016	ELECTRICAL SITE PLAN
E017	ELECTRICAL FINISHES AND ABUTMENTS
E018	ELECTRICAL SPECIFICATIONS
E019	ELECTRICAL SITE PLAN
E020	ELECTRICAL FINISHES AND ABUTMENTS
E021	ELECTRICAL SPECIFICATIONS
E022	ELECTRICAL SITE PLAN
E023	ELECTRICAL FINISHES AND ABUTMENTS
E024	ELECTRICAL SPECIFICATIONS
E025	ELECTRICAL SITE PLAN
E026	ELECTRICAL FINISHES AND ABUTMENTS
E027	ELECTRICAL SPECIFICATIONS
E028	ELECTRICAL SITE PLAN
E029	ELECTRICAL FINISHES AND ABUTMENTS
E030	ELECTRICAL SPECIFICATIONS
E031	ELECTRICAL SITE PLAN
E032	ELECTRICAL FINISHES AND ABUTMENTS
E033	ELECTRICAL SPECIFICATIONS
E034	ELECTRICAL SITE PLAN
E035	ELECTRICAL FINISHES AND ABUTMENTS
E036	ELECTRICAL SPECIFICATIONS
E037	ELECTRICAL SITE PLAN
E038	ELECTRICAL FINISHES AND ABUTMENTS
E039	ELECTRICAL SPECIFICATIONS
E040	ELECTRICAL SITE PLAN
E041	ELECTRICAL FINISHES AND ABUTMENTS
E042	ELECTRICAL SPECIFICATIONS
E043	ELECTRICAL SITE PLAN
E044	ELECTRICAL FINISHES AND ABUTMENTS
E045	ELECTRICAL SPECIFICATIONS
E046	ELECTRICAL SITE PLAN
E047	ELECTRICAL FINISHES AND ABUTMENTS
E048	ELECTRICAL SPECIFICATIONS
E049	ELECTRICAL SITE PLAN
E050	ELECTRICAL FINISHES AND ABUTMENTS
E051	ELECTRICAL SPECIFICATIONS
E052	ELECTRICAL SITE PLAN
E053	ELECTRICAL FINISHES AND ABUTMENTS
E054	ELECTRICAL SPECIFICATIONS
E055	ELECTRICAL SITE PLAN
E056	ELECTRICAL FINISHES AND ABUTMENTS
E057	ELECTRICAL SPECIFICATIONS
E058	ELECTRICAL SITE PLAN
E059	ELECTRICAL FINISHES AND ABUTMENTS
E060	ELECTRICAL SPECIFICATIONS
E061	ELECTRICAL SITE PLAN
E062	ELECTRICAL FINISHES AND ABUTMENTS
E063	ELECTRICAL SPECIFICATIONS
E064	ELECTRICAL SITE PLAN
E065	ELECTRICAL FINISHES AND ABUTMENTS
E066	ELECTRICAL SPECIFICATIONS
E067	ELECTRICAL SITE PLAN
E068	ELECTRICAL FINISHES AND ABUTMENTS
E069	ELECTRICAL SPECIFICATIONS
E070	ELECTRICAL SITE PLAN
E071	ELECTRICAL FINISHES AND ABUTMENTS
E072	ELECTRICAL SPECIFICATIONS
E073	ELECTRICAL SITE PLAN
E074	ELECTRICAL FINISHES AND ABUTMENTS
E075	ELECTRICAL SPECIFICATIONS
E076	ELECTRICAL SITE PLAN
E077	ELECTRICAL FINISHES AND ABUTMENTS
E078	ELECTRICAL SPECIFICATIONS
E079	ELECTRICAL SITE PLAN
E080	ELECTRICAL FINISHES AND ABUTMENTS
E081	ELECTRICAL SPECIFICATIONS
E082	ELECTRICAL SITE PLAN
E083	ELECTRICAL FINISHES AND ABUTMENTS
E084	ELECTRICAL SPECIFICATIONS
E085	ELECTRICAL SITE PLAN
E086	ELECTRICAL FINISHES AND ABUTMENTS
E087	ELECTRICAL SPECIFICATIONS
E088	ELECTRICAL SITE PLAN
E089	ELECTRICAL FINISHES AND ABUTMENTS
E090	ELECTRICAL SPECIFICATIONS
E091	ELECTRICAL SITE PLAN
E092	ELECTRICAL FINISHES AND ABUTMENTS
E093	ELECTRICAL SPECIFICATIONS
E094	ELECTRICAL SITE PLAN
E095	ELECTRICAL FINISHES AND ABUTMENTS
E096	ELECTRICAL SPECIFICATIONS
E097	ELECTRICAL SITE PLAN
E098	ELECTRICAL FINISHES AND ABUTMENTS
E099	ELECTRICAL SPECIFICATIONS
E100	ELECTRICAL SITE PLAN

DRAWN BY: CA  
CHECKED BY: CA  
DATE: -  
PROJECT NO.: -  
SHEET

T1.00









PLUMBING ABBREVIATIONS

AC	ASBESTOS CEMENT	AW	WATER
AD	ASBESTOS DUCT	AW	WATER
AF	ASBESTOS FLOOR	AW	WATER
AG	ASBESTOS GROUND	AW	WATER
AH	ASBESTOS HANGAR	AW	WATER
AI	ASBESTOS INSULATION	AW	WATER
AJ	ASBESTOS JOINT	AW	WATER
AK	ASBESTOS KITCHEN	AW	WATER
AL	ASBESTOS LATH	AW	WATER
AM	ASBESTOS MASONRY	AW	WATER
AN	ASBESTOS NAIL	AW	WATER
AO	ASBESTOS OIL	AW	WATER
AP	ASBESTOS PAPER	AW	WATER
AQ	ASBESTOS PLASTER	AW	WATER
AR	ASBESTOS ROOF	AW	WATER
AS	ASBESTOS SHEET	AW	WATER
AT	ASBESTOS TILE	AW	WATER
AU	ASBESTOS TRAP	AW	WATER
AV	ASBESTOS VENT	AW	WATER
AW	WATER	AW	WATER
AX	ASBESTOS X-RAY	AW	WATER
AY	ASBESTOS YARD	AW	WATER
AZ	ASBESTOS ZONE	AW	WATER

GENERAL NOTES

1. ALL WORK SHALL BE IN ACCORDANCE WITH THE CITY OF RIVERSIDE PLUMBING CODE AND THE CALIFORNIA PLUMBING CODE. THE CONTRACTOR SHALL VERIFY ALL UTILITIES LOCATION, SIZE AND DEPTHS PRIOR TO START OF WORK.
2. CONTRACTOR SHALL COORDINATE WITH ALL OTHER TRADES FOR CLEARANCE AND WORK INCLUDED THEREIN.
3. ALL PIPING SHALL BE INSTALLED PER CALIFORNIA PLUMBING CODE SECTION 702.710 AND 702.715.
4. SLOPE OF FLOWING SEWER SHALL NOT BE LESS THAN 1/8" PER FOOT CHANGE.
5. COORDINATE WITH ELECTRICAL TRADES PRIOR TO ORDERING EQUIPMENT FOR AVAILABLE VOLTAGES AT COMPONENT LOCATIONS.
6. DO NOT USE METAL OR UNLISTED TO WIRING ELECTRICAL SYSTEMS.
7. CONTRACTOR SHALL VERIFY ALL UTILITIES LOCATION, SIZE AND DEPTHS PRIOR TO START OF WORK.
8. CONTRACTOR SHALL VERIFY ALL UTILITIES LOCATION, SIZE AND DEPTHS PRIOR TO START OF WORK.
9. CONTRACTOR SHALL VERIFY ALL UTILITIES LOCATION, SIZE AND DEPTHS PRIOR TO START OF WORK.
10. CONTRACTOR SHALL VERIFY ALL UTILITIES LOCATION, SIZE AND DEPTHS PRIOR TO START OF WORK.
11. CONTRACTOR SHALL VERIFY ALL UTILITIES LOCATION, SIZE AND DEPTHS PRIOR TO START OF WORK.
12. CONTRACTOR SHALL VERIFY ALL UTILITIES LOCATION, SIZE AND DEPTHS PRIOR TO START OF WORK.
13. CONTRACTOR SHALL VERIFY ALL UTILITIES LOCATION, SIZE AND DEPTHS PRIOR TO START OF WORK.
14. CONTRACTOR SHALL VERIFY ALL UTILITIES LOCATION, SIZE AND DEPTHS PRIOR TO START OF WORK.
15. CONTRACTOR SHALL VERIFY ALL UTILITIES LOCATION, SIZE AND DEPTHS PRIOR TO START OF WORK.
16. CONTRACTOR SHALL VERIFY ALL UTILITIES LOCATION, SIZE AND DEPTHS PRIOR TO START OF WORK.
17. PROVIDE WORK NECESSARY TO REPLACE ALL EXISTING WATER MAINS AND SANITARY MAINS AT NO COST TO OWNER.

PLUMBING SHEET INDEX

SHEET NO.	DESCRIPTION
P001	PLUMBING GENERAL NOTES, AMENDMENTS & SYMBOLS
P002	PLUMBING SCHEDULES
P003	PLUMBING SITE PLAN

PIPE SUPPORT NOTES

1. ALL PIPING SHALL BE SUPPORTED IN ACCORDANCE WITH "HANGER" SECTION SPECIFICATIONS. HANGERS SHALL BE INSTALLED AT 10' ON CENTER UNLESS OTHERWISE SPECIFIED.
2. HANGERS SHALL BE INSTALLED AT 10' ON CENTER UNLESS OTHERWISE SPECIFIED.
3. HANGERS SHALL BE INSTALLED AT 10' ON CENTER UNLESS OTHERWISE SPECIFIED.
4. HANGERS SHALL BE INSTALLED AT 10' ON CENTER UNLESS OTHERWISE SPECIFIED.
5. HANGERS SHALL BE INSTALLED AT 10' ON CENTER UNLESS OTHERWISE SPECIFIED.
6. HANGERS SHALL BE INSTALLED AT 10' ON CENTER UNLESS OTHERWISE SPECIFIED.
7. HANGERS SHALL BE INSTALLED AT 10' ON CENTER UNLESS OTHERWISE SPECIFIED.
8. HANGERS SHALL BE INSTALLED AT 10' ON CENTER UNLESS OTHERWISE SPECIFIED.
9. HANGERS SHALL BE INSTALLED AT 10' ON CENTER UNLESS OTHERWISE SPECIFIED.
10. HANGERS SHALL BE INSTALLED AT 10' ON CENTER UNLESS OTHERWISE SPECIFIED.
11. HANGERS SHALL BE INSTALLED AT 10' ON CENTER UNLESS OTHERWISE SPECIFIED.
12. HANGERS SHALL BE INSTALLED AT 10' ON CENTER UNLESS OTHERWISE SPECIFIED.
13. HANGERS SHALL BE INSTALLED AT 10' ON CENTER UNLESS OTHERWISE SPECIFIED.
14. HANGERS SHALL BE INSTALLED AT 10' ON CENTER UNLESS OTHERWISE SPECIFIED.
15. HANGERS SHALL BE INSTALLED AT 10' ON CENTER UNLESS OTHERWISE SPECIFIED.
16. HANGERS SHALL BE INSTALLED AT 10' ON CENTER UNLESS OTHERWISE SPECIFIED.
17. HANGERS SHALL BE INSTALLED AT 10' ON CENTER UNLESS OTHERWISE SPECIFIED.
18. HANGERS SHALL BE INSTALLED AT 10' ON CENTER UNLESS OTHERWISE SPECIFIED.
19. HANGERS SHALL BE INSTALLED AT 10' ON CENTER UNLESS OTHERWISE SPECIFIED.
20. HANGERS SHALL BE INSTALLED AT 10' ON CENTER UNLESS OTHERWISE SPECIFIED.

SEISMIC NOTES

1. ALL PIPING SHALL BE SEISMICALLY ANCHORED TO THE STRUCTURE IN ACCORDANCE WITH THE CALIFORNIA SEISMIC CODE AND THE CITY OF RIVERSIDE SEISMIC CODE.
2. ALL PIPING SHALL BE SEISMICALLY ANCHORED TO THE STRUCTURE IN ACCORDANCE WITH THE CALIFORNIA SEISMIC CODE AND THE CITY OF RIVERSIDE SEISMIC CODE.
3. ALL PIPING SHALL BE SEISMICALLY ANCHORED TO THE STRUCTURE IN ACCORDANCE WITH THE CALIFORNIA SEISMIC CODE AND THE CITY OF RIVERSIDE SEISMIC CODE.
4. ALL PIPING SHALL BE SEISMICALLY ANCHORED TO THE STRUCTURE IN ACCORDANCE WITH THE CALIFORNIA SEISMIC CODE AND THE CITY OF RIVERSIDE SEISMIC CODE.
5. ALL PIPING SHALL BE SEISMICALLY ANCHORED TO THE STRUCTURE IN ACCORDANCE WITH THE CALIFORNIA SEISMIC CODE AND THE CITY OF RIVERSIDE SEISMIC CODE.
6. ALL PIPING SHALL BE SEISMICALLY ANCHORED TO THE STRUCTURE IN ACCORDANCE WITH THE CALIFORNIA SEISMIC CODE AND THE CITY OF RIVERSIDE SEISMIC CODE.
7. ALL PIPING SHALL BE SEISMICALLY ANCHORED TO THE STRUCTURE IN ACCORDANCE WITH THE CALIFORNIA SEISMIC CODE AND THE CITY OF RIVERSIDE SEISMIC CODE.
8. ALL PIPING SHALL BE SEISMICALLY ANCHORED TO THE STRUCTURE IN ACCORDANCE WITH THE CALIFORNIA SEISMIC CODE AND THE CITY OF RIVERSIDE SEISMIC CODE.
9. ALL PIPING SHALL BE SEISMICALLY ANCHORED TO THE STRUCTURE IN ACCORDANCE WITH THE CALIFORNIA SEISMIC CODE AND THE CITY OF RIVERSIDE SEISMIC CODE.
10. ALL PIPING SHALL BE SEISMICALLY ANCHORED TO THE STRUCTURE IN ACCORDANCE WITH THE CALIFORNIA SEISMIC CODE AND THE CITY OF RIVERSIDE SEISMIC CODE.
11. ALL PIPING SHALL BE SEISMICALLY ANCHORED TO THE STRUCTURE IN ACCORDANCE WITH THE CALIFORNIA SEISMIC CODE AND THE CITY OF RIVERSIDE SEISMIC CODE.
12. ALL PIPING SHALL BE SEISMICALLY ANCHORED TO THE STRUCTURE IN ACCORDANCE WITH THE CALIFORNIA SEISMIC CODE AND THE CITY OF RIVERSIDE SEISMIC CODE.
13. ALL PIPING SHALL BE SEISMICALLY ANCHORED TO THE STRUCTURE IN ACCORDANCE WITH THE CALIFORNIA SEISMIC CODE AND THE CITY OF RIVERSIDE SEISMIC CODE.
14. ALL PIPING SHALL BE SEISMICALLY ANCHORED TO THE STRUCTURE IN ACCORDANCE WITH THE CALIFORNIA SEISMIC CODE AND THE CITY OF RIVERSIDE SEISMIC CODE.
15. ALL PIPING SHALL BE SEISMICALLY ANCHORED TO THE STRUCTURE IN ACCORDANCE WITH THE CALIFORNIA SEISMIC CODE AND THE CITY OF RIVERSIDE SEISMIC CODE.
16. ALL PIPING SHALL BE SEISMICALLY ANCHORED TO THE STRUCTURE IN ACCORDANCE WITH THE CALIFORNIA SEISMIC CODE AND THE CITY OF RIVERSIDE SEISMIC CODE.
17. ALL PIPING SHALL BE SEISMICALLY ANCHORED TO THE STRUCTURE IN ACCORDANCE WITH THE CALIFORNIA SEISMIC CODE AND THE CITY OF RIVERSIDE SEISMIC CODE.
18. ALL PIPING SHALL BE SEISMICALLY ANCHORED TO THE STRUCTURE IN ACCORDANCE WITH THE CALIFORNIA SEISMIC CODE AND THE CITY OF RIVERSIDE SEISMIC CODE.
19. ALL PIPING SHALL BE SEISMICALLY ANCHORED TO THE STRUCTURE IN ACCORDANCE WITH THE CALIFORNIA SEISMIC CODE AND THE CITY OF RIVERSIDE SEISMIC CODE.
20. ALL PIPING SHALL BE SEISMICALLY ANCHORED TO THE STRUCTURE IN ACCORDANCE WITH THE CALIFORNIA SEISMIC CODE AND THE CITY OF RIVERSIDE SEISMIC CODE.

DIESEL FUEL OIL TANK SEQUENCE OF OPERATION

1. DIESEL FUEL OIL TANK SEQUENCE OF OPERATION.
2. DIESEL FUEL OIL TANK SEQUENCE OF OPERATION.
3. DIESEL FUEL OIL TANK SEQUENCE OF OPERATION.
4. DIESEL FUEL OIL TANK SEQUENCE OF OPERATION.
5. DIESEL FUEL OIL TANK SEQUENCE OF OPERATION.
6. DIESEL FUEL OIL TANK SEQUENCE OF OPERATION.
7. DIESEL FUEL OIL TANK SEQUENCE OF OPERATION.
8. DIESEL FUEL OIL TANK SEQUENCE OF OPERATION.
9. DIESEL FUEL OIL TANK SEQUENCE OF OPERATION.
10. DIESEL FUEL OIL TANK SEQUENCE OF OPERATION.
11. DIESEL FUEL OIL TANK SEQUENCE OF OPERATION.
12. DIESEL FUEL OIL TANK SEQUENCE OF OPERATION.
13. DIESEL FUEL OIL TANK SEQUENCE OF OPERATION.
14. DIESEL FUEL OIL TANK SEQUENCE OF OPERATION.
15. DIESEL FUEL OIL TANK SEQUENCE OF OPERATION.
16. DIESEL FUEL OIL TANK SEQUENCE OF OPERATION.
17. DIESEL FUEL OIL TANK SEQUENCE OF OPERATION.
18. DIESEL FUEL OIL TANK SEQUENCE OF OPERATION.
19. DIESEL FUEL OIL TANK SEQUENCE OF OPERATION.
20. DIESEL FUEL OIL TANK SEQUENCE OF OPERATION.

PLUMBING SYMBOLS

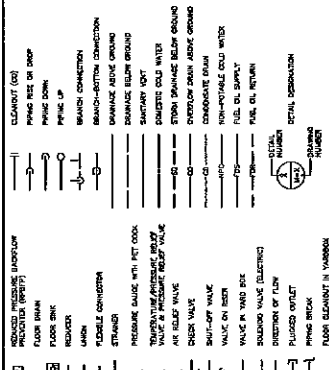

DIESEL FUEL OIL EQUIPMENT SCHEDULE

SYMBOL	EQUIPMENT	LOCATION	QTY	REMARKS
1	DIESEL FUEL OIL TANK	10	1	10' DIA. X 10' HIGH. 1000 GALS. CAPACITY.
2	DIESEL FUEL OIL TANK	10	1	10' DIA. X 10' HIGH. 1000 GALS. CAPACITY.
3	DIESEL FUEL OIL TANK	10	1	10' DIA. X 10' HIGH. 1000 GALS. CAPACITY.
4	DIESEL FUEL OIL TANK	10	1	10' DIA. X 10' HIGH. 1000 GALS. CAPACITY.
5	DIESEL FUEL OIL TANK	10	1	10' DIA. X 10' HIGH. 1000 GALS. CAPACITY.
6	DIESEL FUEL OIL TANK	10	1	10' DIA. X 10' HIGH. 1000 GALS. CAPACITY.
7	DIESEL FUEL OIL TANK	10	1	10' DIA. X 10' HIGH. 1000 GALS. CAPACITY.
8	DIESEL FUEL OIL TANK	10	1	10' DIA. X 10' HIGH. 1000 GALS. CAPACITY.
9	DIESEL FUEL OIL TANK	10	1	10' DIA. X 10' HIGH. 1000 GALS. CAPACITY.
10	DIESEL FUEL OIL TANK	10	1	10' DIA. X 10' HIGH. 1000 GALS. CAPACITY.
11	DIESEL FUEL OIL TANK	10	1	10' DIA. X 10' HIGH. 1000 GALS. CAPACITY.
12	DIESEL FUEL OIL TANK	10	1	10' DIA. X 10' HIGH. 1000 GALS. CAPACITY.
13	DIESEL FUEL OIL TANK	10	1	10' DIA. X 10' HIGH. 1000 GALS. CAPACITY.
14	DIESEL FUEL OIL TANK	10	1	10' DIA. X 10' HIGH. 1000 GALS. CAPACITY.
15	DIESEL FUEL OIL TANK	10	1	10' DIA. X 10' HIGH. 1000 GALS. CAPACITY.
16	DIESEL FUEL OIL TANK	10	1	10' DIA. X 10' HIGH. 1000 GALS. CAPACITY.
17	DIESEL FUEL OIL TANK	10	1	10' DIA. X 10' HIGH. 1000 GALS. CAPACITY.
18	DIESEL FUEL OIL TANK	10	1	10' DIA. X 10' HIGH. 1000 GALS. CAPACITY.
19	DIESEL FUEL OIL TANK	10	1	10' DIA. X 10' HIGH. 1000 GALS. CAPACITY.
20	DIESEL FUEL OIL TANK	10	1	10' DIA. X 10' HIGH. 1000 GALS. CAPACITY.

DIESEL FUEL OIL PUMP SCHEDULE

SYMBOL	LOCATION	QTY	REMARKS
1	DIESEL FUEL OIL PUMP	1	10 HP. 1000 GALS. CAPACITY.
2	DIESEL FUEL OIL PUMP	1	10 HP. 1000 GALS. CAPACITY.
3	DIESEL FUEL OIL PUMP	1	10 HP. 1000 GALS. CAPACITY.
4	DIESEL FUEL OIL PUMP	1	10 HP. 1000 GALS. CAPACITY.
5	DIESEL FUEL OIL PUMP	1	10 HP. 1000 GALS. CAPACITY.
6	DIESEL FUEL OIL PUMP	1	10 HP. 1000 GALS. CAPACITY.
7	DIESEL FUEL OIL PUMP	1	10 HP. 1000 GALS. CAPACITY.
8	DIESEL FUEL OIL PUMP	1	10 HP. 1000 GALS. CAPACITY.
9	DIESEL FUEL OIL PUMP	1	10 HP. 1000 GALS. CAPACITY.
10	DIESEL FUEL OIL PUMP	1	10 HP. 1000 GALS. CAPACITY.
11	DIESEL FUEL OIL PUMP	1	10 HP. 1000 GALS. CAPACITY.
12	DIESEL FUEL OIL PUMP	1	10 HP. 1000 GALS. CAPACITY.
13	DIESEL FUEL OIL PUMP	1	10 HP. 1000 GALS. CAPACITY.
14	DIESEL FUEL OIL PUMP	1	10 HP. 1000 GALS. CAPACITY.
15	DIESEL FUEL OIL PUMP	1	10 HP. 1000 GALS. CAPACITY.
16	DIESEL FUEL OIL PUMP	1	10 HP. 1000 GALS. CAPACITY.
17	DIESEL FUEL OIL PUMP	1	10 HP. 1000 GALS. CAPACITY.
18	DIESEL FUEL OIL PUMP	1	10 HP. 1000 GALS. CAPACITY.
19	DIESEL FUEL OIL PUMP	1	10 HP. 1000 GALS. CAPACITY.
20	DIESEL FUEL OIL PUMP	1	10 HP. 1000 GALS. CAPACITY.

COOLING WATER PUMP

SYMBOL	LOCATION	QTY	REMARKS
1	COOLING WATER PUMP	1	10 HP. 1000 GALS. CAPACITY.
2	COOLING WATER PUMP	1	10 HP. 1000 GALS. CAPACITY.
3	COOLING WATER PUMP	1	10 HP. 1000 GALS. CAPACITY.
4	COOLING WATER PUMP	1	10 HP. 1000 GALS. CAPACITY.
5	COOLING WATER PUMP	1	10 HP. 1000 GALS. CAPACITY.
6	COOLING WATER PUMP	1	10 HP. 1000 GALS. CAPACITY.
7	COOLING WATER PUMP	1	10 HP. 1000 GALS. CAPACITY.
8	COOLING WATER PUMP	1	10 HP. 1000 GALS. CAPACITY.
9	COOLING WATER PUMP	1	10 HP. 1000 GALS. CAPACITY.
10	COOLING WATER PUMP	1	10 HP. 1000 GALS. CAPACITY.
11	COOLING WATER PUMP	1	10 HP. 1000 GALS. CAPACITY.
12	COOLING WATER PUMP	1	10 HP. 1000 GALS. CAPACITY.
13	COOLING WATER PUMP	1	10 HP. 1000 GALS. CAPACITY.
14	COOLING WATER PUMP	1	10 HP. 1000 GALS. CAPACITY.
15	COOLING WATER PUMP	1	10 HP. 1000 GALS. CAPACITY.
16	COOLING WATER PUMP	1	10 HP. 1000 GALS. CAPACITY.
17	COOLING WATER PUMP	1	10 HP. 1000 GALS. CAPACITY.
18	COOLING WATER PUMP	1	10 HP. 1000 GALS. CAPACITY.
19	COOLING WATER PUMP	1	10 HP. 1000 GALS. CAPACITY.
20	COOLING WATER PUMP	1	10 HP. 1000 GALS. CAPACITY.

WATER TANK

SYMBOL	LOCATION	QTY	REMARKS
1	WATER TANK	1	10' DIA. X 10' HIGH. 1000 GALS. CAPACITY.
2	WATER TANK	1	10' DIA. X 10' HIGH. 1000 GALS. CAPACITY.
3	WATER TANK	1	10' DIA. X 10' HIGH. 1000 GALS. CAPACITY.
4	WATER TANK	1	10' DIA. X 10' HIGH. 1000 GALS. CAPACITY.
5	WATER TANK	1	



- SHEET NOTES**
1. 2" DIA. VENT WITH PRESSURE VACUUM GAP AT 15 FEET ABOVE FINISHED GRADE.
  2. 2" DIA. HANDED.
  3. 2" DIA. HANDED WITH 1/2" DIA. W/THROUGHS PORT AND DRAIN VALVE.
  4. 2" DIA. LEAK DETECTION PORT.
  5. 2" DIA. COMMUNICATION PORT.
  6. 2" DIA. COMMUNICATION PORT, 1/2" DIA. COMMUNICATION PORT, (SEE ELECTRICAL PLANS).
  7. 1/2" DIA. VENT WITH PRESSURE VACUUM GAP AT 15 FEET ABOVE FINISHED GRADE.
  8. 1/2" DIA. VENT WITH PRESSURE VACUUM GAP AT 15 FEET ABOVE FINISHED GRADE.

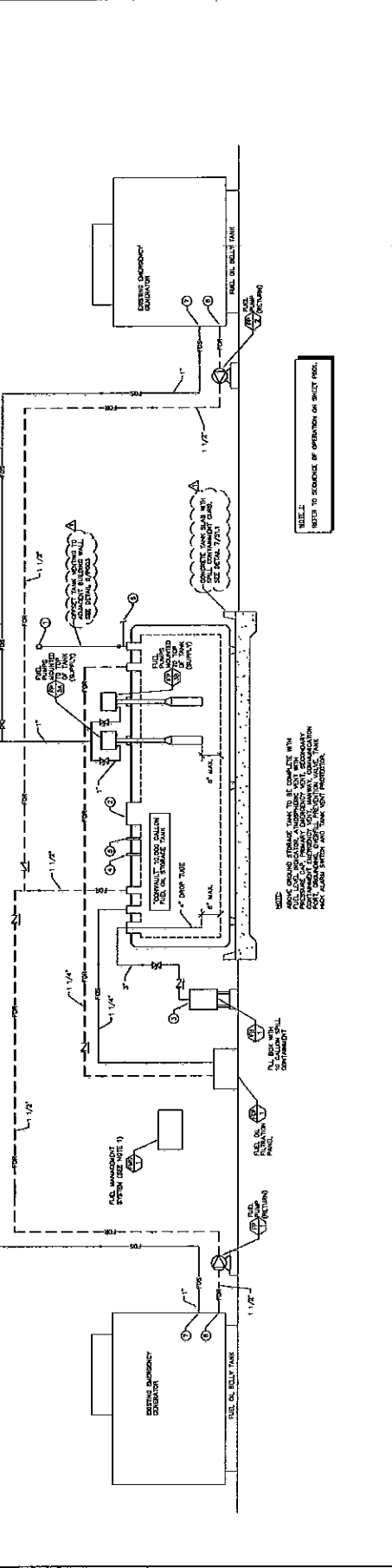

- EXISTING SOURCE OF OPERATIONS**
1. EXISTING STORAGE TANK TO BE COMPLETED WITH PIPING AND VALVES. THE TANK LEVEL IS TO BE MONITORED BY A PRESSURE TRANSDUCER (PT) LOCATED ON THE TANK. THE TANK LEVEL IS TO BE MONITORED BY A PRESSURE TRANSDUCER (PT) LOCATED ON THE TANK. THE TANK LEVEL IS TO BE MONITORED BY A PRESSURE TRANSDUCER (PT) LOCATED ON THE TANK.
  2. EXISTING STORAGE TANK TO BE COMPLETED WITH PIPING AND VALVES. THE TANK LEVEL IS TO BE MONITORED BY A PRESSURE TRANSDUCER (PT) LOCATED ON THE TANK. THE TANK LEVEL IS TO BE MONITORED BY A PRESSURE TRANSDUCER (PT) LOCATED ON THE TANK.
  3. EXISTING STORAGE TANK TO BE COMPLETED WITH PIPING AND VALVES. THE TANK LEVEL IS TO BE MONITORED BY A PRESSURE TRANSDUCER (PT) LOCATED ON THE TANK. THE TANK LEVEL IS TO BE MONITORED BY A PRESSURE TRANSDUCER (PT) LOCATED ON THE TANK.

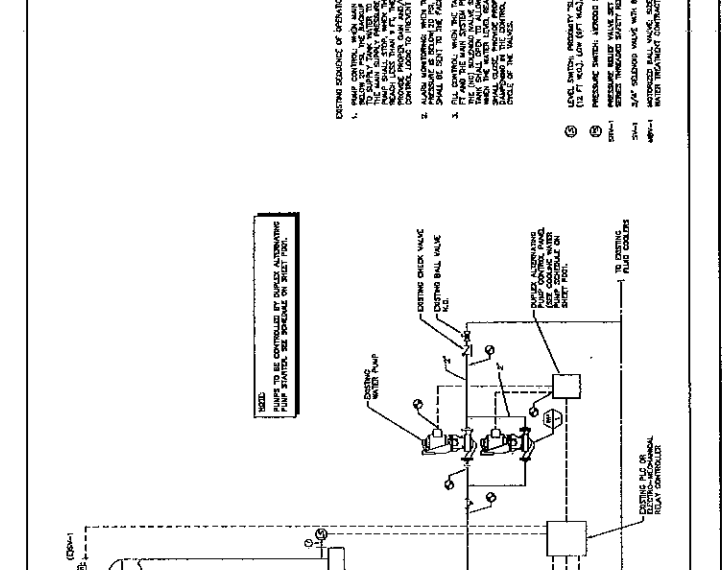













# COUNTY OF RIVERSIDE FACILITY DISTRIBUTION SYSTEM RENOVATION

## SINGLE LINE DIAGRAM

### E003

SHEET

PROJECT NO.	160 F CHICAGO AVENUE
SCALE	N.T.S.
DATE	
CHECKED BY	CD
DRAWN BY	CD

DATE	
REVISION	
BY	
DATE	



**DCR ENGINEERS**  
 Consulting Mechanical and Electrical Engineers  
 160 F CHICAGO AVENUE  
 RIVERSIDE, CALIFORNIA 92507  
 PHONE: (951) 514-1100  
 FAX: (951) 514-1101  
 WWW.DCRENG.COM

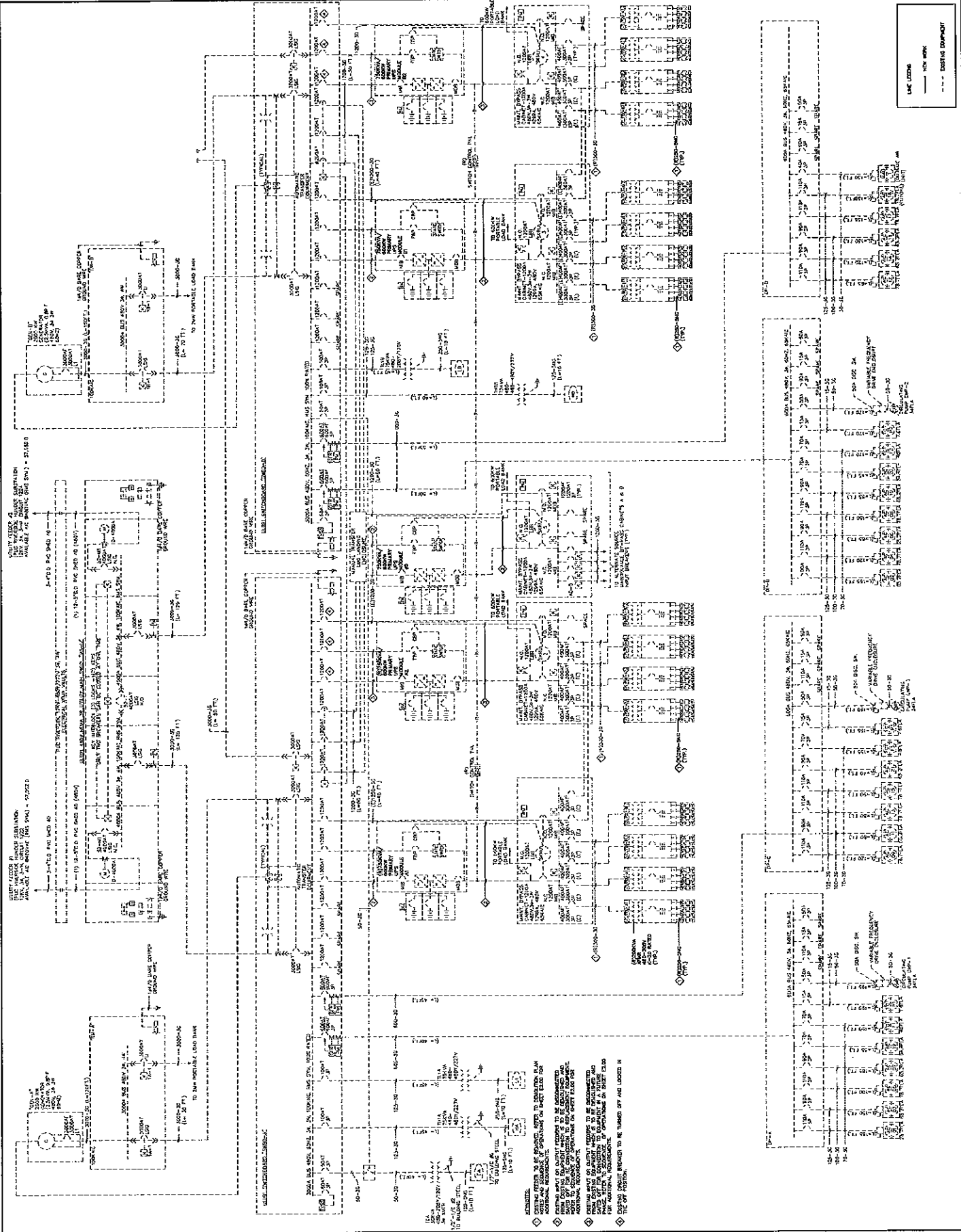



DEMOLITION PLAN

SCALE  
1/8" = 1'-0"

1

DATE	11/08/10
REVISION	
DESCRIPTION	
BY	
CHECKED BY	GP
DATE	
SCALE	N.T.S.
PROJECT NO.	
SHEET	E200

DATE	11/08/10
REVISION	
DESCRIPTION	
BY	
CHECKED BY	GP
DATE	
SCALE	N.T.S.
PROJECT NO.	
SHEET	E200

DEMOLITION PLAN

COUNTY OF RIVERSIDE RCIT RC3  
FACILITY DISTRIBUTION SYSTEM RENOVATION

1960 F CHICAGO AVENUE  
RIVERSIDE, CALIFORNIA 92507



DCCM ENGINEERS  
Civil, Mechanical and Electrical Engineers

1600 RCT Facility Renovation - PART 05000-11000000.dwg 11-08-10 09:27 AM

SHEET NOTES

- 1. ALL EXISTING UTILITIES AND STRUCTURES SHALL BE DEMOLISHED AND REMOVED FROM THE SITE. ALL UTILITIES SHALL BE CAPED AT THE STREET OR AT THE POINT OF ENTRY TO THE PROPERTY. ALL STRUCTURES SHALL BE DEMOLISHED AND REMOVED FROM THE SITE.
- 2. ALL EXISTING UTILITIES SHALL BE DEMOLISHED AND REMOVED FROM THE SITE. ALL UTILITIES SHALL BE CAPED AT THE STREET OR AT THE POINT OF ENTRY TO THE PROPERTY. ALL STRUCTURES SHALL BE DEMOLISHED AND REMOVED FROM THE SITE.
- 3. ALL EXISTING UTILITIES SHALL BE DEMOLISHED AND REMOVED FROM THE SITE. ALL UTILITIES SHALL BE CAPED AT THE STREET OR AT THE POINT OF ENTRY TO THE PROPERTY. ALL STRUCTURES SHALL BE DEMOLISHED AND REMOVED FROM THE SITE.
- 4. ALL EXISTING UTILITIES SHALL BE DEMOLISHED AND REMOVED FROM THE SITE. ALL UTILITIES SHALL BE CAPED AT THE STREET OR AT THE POINT OF ENTRY TO THE PROPERTY. ALL STRUCTURES SHALL BE DEMOLISHED AND REMOVED FROM THE SITE.
- 5. ALL EXISTING UTILITIES SHALL BE DEMOLISHED AND REMOVED FROM THE SITE. ALL UTILITIES SHALL BE CAPED AT THE STREET OR AT THE POINT OF ENTRY TO THE PROPERTY. ALL STRUCTURES SHALL BE DEMOLISHED AND REMOVED FROM THE SITE.
- 6. ALL EXISTING UTILITIES SHALL BE DEMOLISHED AND REMOVED FROM THE SITE. ALL UTILITIES SHALL BE CAPED AT THE STREET OR AT THE POINT OF ENTRY TO THE PROPERTY. ALL STRUCTURES SHALL BE DEMOLISHED AND REMOVED FROM THE SITE.
- 7. ALL EXISTING UTILITIES SHALL BE DEMOLISHED AND REMOVED FROM THE SITE. ALL UTILITIES SHALL BE CAPED AT THE STREET OR AT THE POINT OF ENTRY TO THE PROPERTY. ALL STRUCTURES SHALL BE DEMOLISHED AND REMOVED FROM THE SITE.
- 8. ALL EXISTING UTILITIES SHALL BE DEMOLISHED AND REMOVED FROM THE SITE. ALL UTILITIES SHALL BE CAPED AT THE STREET OR AT THE POINT OF ENTRY TO THE PROPERTY. ALL STRUCTURES SHALL BE DEMOLISHED AND REMOVED FROM THE SITE.
- 9. ALL EXISTING UTILITIES SHALL BE DEMOLISHED AND REMOVED FROM THE SITE. ALL UTILITIES SHALL BE CAPED AT THE STREET OR AT THE POINT OF ENTRY TO THE PROPERTY. ALL STRUCTURES SHALL BE DEMOLISHED AND REMOVED FROM THE SITE.
- 10. ALL EXISTING UTILITIES SHALL BE DEMOLISHED AND REMOVED FROM THE SITE. ALL UTILITIES SHALL BE CAPED AT THE STREET OR AT THE POINT OF ENTRY TO THE PROPERTY. ALL STRUCTURES SHALL BE DEMOLISHED AND REMOVED FROM THE SITE.

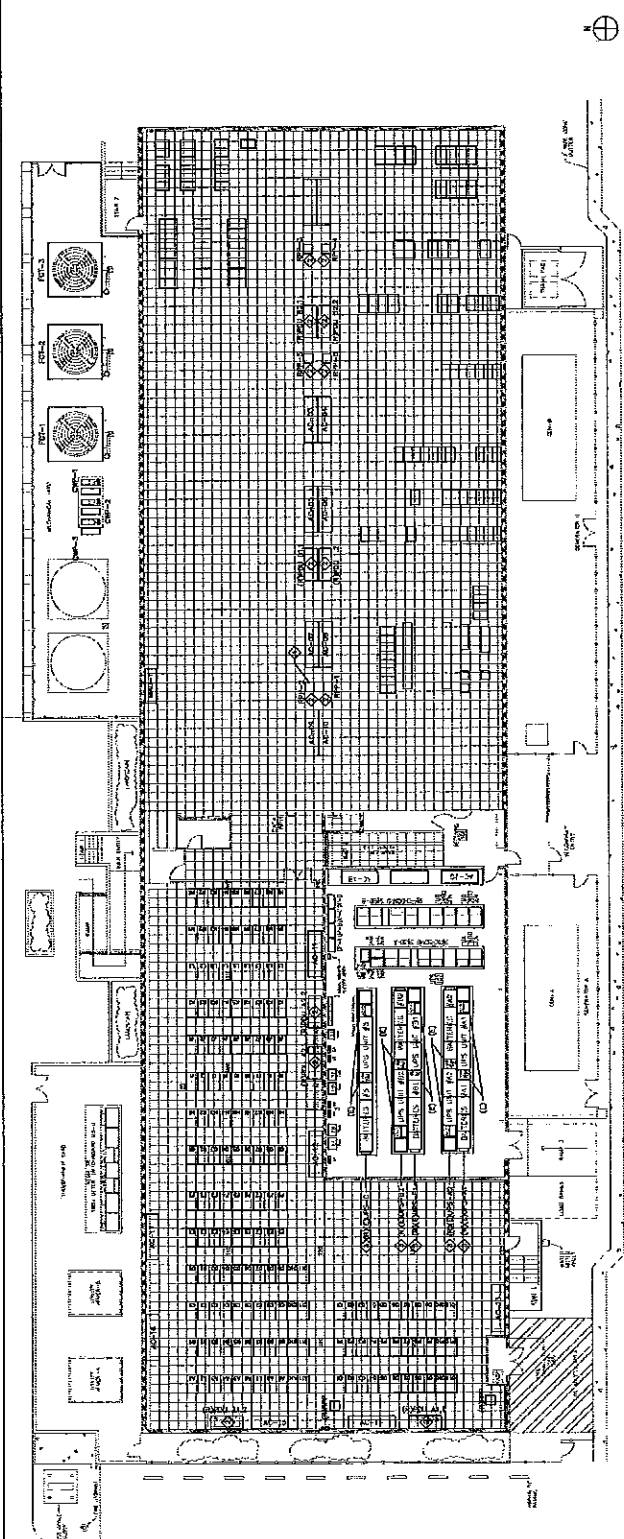

**NOTES:**

1. ALL EXISTING UTILITIES AND STRUCTURES SHALL BE DEMOLISHED AND REMOVED FROM THE SITE. ALL UTILITIES SHALL BE CAPED AT THE STREET OR AT THE POINT OF ENTRY TO THE PROPERTY. ALL STRUCTURES SHALL BE DEMOLISHED AND REMOVED FROM THE SITE.
2. ALL EXISTING UTILITIES SHALL BE DEMOLISHED AND REMOVED FROM THE SITE. ALL UTILITIES SHALL BE CAPED AT THE STREET OR AT THE POINT OF ENTRY TO THE PROPERTY. ALL STRUCTURES SHALL BE DEMOLISHED AND REMOVED FROM THE SITE.
3. ALL EXISTING UTILITIES SHALL BE DEMOLISHED AND REMOVED FROM THE SITE. ALL UTILITIES SHALL BE CAPED AT THE STREET OR AT THE POINT OF ENTRY TO THE PROPERTY. ALL STRUCTURES SHALL BE DEMOLISHED AND REMOVED FROM THE SITE.
4. ALL EXISTING UTILITIES SHALL BE DEMOLISHED AND REMOVED FROM THE SITE. ALL UTILITIES SHALL BE CAPED AT THE STREET OR AT THE POINT OF ENTRY TO THE PROPERTY. ALL STRUCTURES SHALL BE DEMOLISHED AND REMOVED FROM THE SITE.
5. ALL EXISTING UTILITIES SHALL BE DEMOLISHED AND REMOVED FROM THE SITE. ALL UTILITIES SHALL BE CAPED AT THE STREET OR AT THE POINT OF ENTRY TO THE PROPERTY. ALL STRUCTURES SHALL BE DEMOLISHED AND REMOVED FROM THE SITE.
6. ALL EXISTING UTILITIES SHALL BE DEMOLISHED AND REMOVED FROM THE SITE. ALL UTILITIES SHALL BE CAPED AT THE STREET OR AT THE POINT OF ENTRY TO THE PROPERTY. ALL STRUCTURES SHALL BE DEMOLISHED AND REMOVED FROM THE SITE.
7. ALL EXISTING UTILITIES SHALL BE DEMOLISHED AND REMOVED FROM THE SITE. ALL UTILITIES SHALL BE CAPED AT THE STREET OR AT THE POINT OF ENTRY TO THE PROPERTY. ALL STRUCTURES SHALL BE DEMOLISHED AND REMOVED FROM THE SITE.
8. ALL EXISTING UTILITIES SHALL BE DEMOLISHED AND REMOVED FROM THE SITE. ALL UTILITIES SHALL BE CAPED AT THE STREET OR AT THE POINT OF ENTRY TO THE PROPERTY. ALL STRUCTURES SHALL BE DEMOLISHED AND REMOVED FROM THE SITE.
9. ALL EXISTING UTILITIES SHALL BE DEMOLISHED AND REMOVED FROM THE SITE. ALL UTILITIES SHALL BE CAPED AT THE STREET OR AT THE POINT OF ENTRY TO THE PROPERTY. ALL STRUCTURES SHALL BE DEMOLISHED AND REMOVED FROM THE SITE.
10. ALL EXISTING UTILITIES SHALL BE DEMOLISHED AND REMOVED FROM THE SITE. ALL UTILITIES SHALL BE CAPED AT THE STREET OR AT THE POINT OF ENTRY TO THE PROPERTY. ALL STRUCTURES SHALL BE DEMOLISHED AND REMOVED FROM THE SITE.





PROJECT TITLE  
 ENLARGED ELECTRICAL  
 REMODEL PLAN  
 EQUIPMENT YARDS

PROJECT  
 COUNTY OF RIVERSIDE FACILITY DISTRIBUTION SYSTEM RENOVATION  
 1980 F CHICAGO AVENUE  
 RIVERSIDE, CALIFORNIA 92507

CLIENT  
 COUNTY OF RIVERSIDE



DATE  
 05/15/2017

DRAWN BY: **CS**

CHECKED BY: **OF**

DATE: **5/15/17**

SCALE: **N.T.S.**

PROJECT No.: **E203**

SHEET

E203

SCALE  
 3/8" = 1'-0"

SCALE  
 3/8" = 1'-0"

SCALE  
 3/8" = 1'-0"

SCALE  
 3/8" = 1'-0"

SCALE  
 3/8" = 1'-0"

SCALE  
 3/8" = 1'-0"

SCALE  
 3/8" = 1'-0"

SCALE  
 3/8" = 1'-0"

SCALE  
 3/8" = 1'-0"

SCALE  
 3/8" = 1'-0"

SCALE  
 3/8" = 1'-0"

SCALE  
 3/8" = 1'-0"

SCALE  
 3/8" = 1'-0"

SCALE  
 3/8" = 1'-0"

SCALE  
 3/8" = 1'-0"

- SHEET NOTES**
- 1. PROVIDE ALL WORK WITH PERMANENT IDENTIFICATION AND LABELING TO FACILITATE MAINTENANCE AND REPAIR.
  - 2. ALL WORK SHALL BE IN ACCORDANCE WITH THE LATEST EDITIONS OF THE NATIONAL ELECTRICAL CODE (NEC) AND THE CALIFORNIA ELECTRICAL CODE (CEC).
  - 3. ALL WORK SHALL BE IN ACCORDANCE WITH THE LATEST EDITIONS OF THE NATIONAL FIRE ALARM AND SIGNAL CODE (NFPA 72) AND THE CALIFORNIA FIRE ALARM AND SIGNAL CODE (CFAS).
  - 4. ALL WORK SHALL BE IN ACCORDANCE WITH THE LATEST EDITIONS OF THE NATIONAL ELECTRICAL SAFETY CODE (NESC) AND THE CALIFORNIA ELECTRICAL SAFETY CODE (CES).
  - 5. ALL WORK SHALL BE IN ACCORDANCE WITH THE LATEST EDITIONS OF THE NATIONAL ELECTRICAL QUALITY STANDARDS (NEQS) AND THE CALIFORNIA ELECTRICAL QUALITY STANDARDS (CEQS).
  - 6. ALL WORK SHALL BE IN ACCORDANCE WITH THE LATEST EDITIONS OF THE NATIONAL ELECTRICAL INSTALLATION STANDARDS (NEIS) AND THE CALIFORNIA ELECTRICAL INSTALLATION STANDARDS (CEIS).
  - 7. ALL WORK SHALL BE IN ACCORDANCE WITH THE LATEST EDITIONS OF THE NATIONAL ELECTRICAL TESTING STANDARDS (NETS) AND THE CALIFORNIA ELECTRICAL TESTING STANDARDS (CETS).
  - 8. ALL WORK SHALL BE IN ACCORDANCE WITH THE LATEST EDITIONS OF THE NATIONAL ELECTRICAL MAINTENANCE STANDARDS (NEMS) AND THE CALIFORNIA ELECTRICAL MAINTENANCE STANDARDS (CEMS).
  - 9. ALL WORK SHALL BE IN ACCORDANCE WITH THE LATEST EDITIONS OF THE NATIONAL ELECTRICAL REPAIR STANDARDS (NERS) AND THE CALIFORNIA ELECTRICAL REPAIR STANDARDS (CERS).
  - 10. ALL WORK SHALL BE IN ACCORDANCE WITH THE LATEST EDITIONS OF THE NATIONAL ELECTRICAL REPLACEMENT STANDARDS (NERS) AND THE CALIFORNIA ELECTRICAL REPLACEMENT STANDARDS (CERS).
  - 11. ALL WORK SHALL BE IN ACCORDANCE WITH THE LATEST EDITIONS OF THE NATIONAL ELECTRICAL REMEDIATION STANDARDS (NERS) AND THE CALIFORNIA ELECTRICAL REMEDIATION STANDARDS (CERS).
  - 12. ALL WORK SHALL BE IN ACCORDANCE WITH THE LATEST EDITIONS OF THE NATIONAL ELECTRICAL RESTORATION STANDARDS (NERS) AND THE CALIFORNIA ELECTRICAL RESTORATION STANDARDS (CERS).
  - 13. ALL WORK SHALL BE IN ACCORDANCE WITH THE LATEST EDITIONS OF THE NATIONAL ELECTRICAL REPAIR STANDARDS (NERS) AND THE CALIFORNIA ELECTRICAL REPAIR STANDARDS (CERS).
  - 14. ALL WORK SHALL BE IN ACCORDANCE WITH THE LATEST EDITIONS OF THE NATIONAL ELECTRICAL REPLACEMENT STANDARDS (NERS) AND THE CALIFORNIA ELECTRICAL REPLACEMENT STANDARDS (CERS).
  - 15. ALL WORK SHALL BE IN ACCORDANCE WITH THE LATEST EDITIONS OF THE NATIONAL ELECTRICAL REMEDIATION STANDARDS (NERS) AND THE CALIFORNIA ELECTRICAL REMEDIATION STANDARDS (CERS).
  - 16. ALL WORK SHALL BE IN ACCORDANCE WITH THE LATEST EDITIONS OF THE NATIONAL ELECTRICAL RESTORATION STANDARDS (NERS) AND THE CALIFORNIA ELECTRICAL RESTORATION STANDARDS (CERS).
  - 17. ALL WORK SHALL BE IN ACCORDANCE WITH THE LATEST EDITIONS OF THE NATIONAL ELECTRICAL REPAIR STANDARDS (NERS) AND THE CALIFORNIA ELECTRICAL REPAIR STANDARDS (CERS).
  - 18. ALL WORK SHALL BE IN ACCORDANCE WITH THE LATEST EDITIONS OF THE NATIONAL ELECTRICAL REPLACEMENT STANDARDS (NERS) AND THE CALIFORNIA ELECTRICAL REPLACEMENT STANDARDS (CERS).
  - 19. ALL WORK SHALL BE IN ACCORDANCE WITH THE LATEST EDITIONS OF THE NATIONAL ELECTRICAL REMEDIATION STANDARDS (NERS) AND THE CALIFORNIA ELECTRICAL REMEDIATION STANDARDS (CERS).
  - 20. ALL WORK SHALL BE IN ACCORDANCE WITH THE LATEST EDITIONS OF THE NATIONAL ELECTRICAL RESTORATION STANDARDS (NERS) AND THE CALIFORNIA ELECTRICAL RESTORATION STANDARDS (CERS).

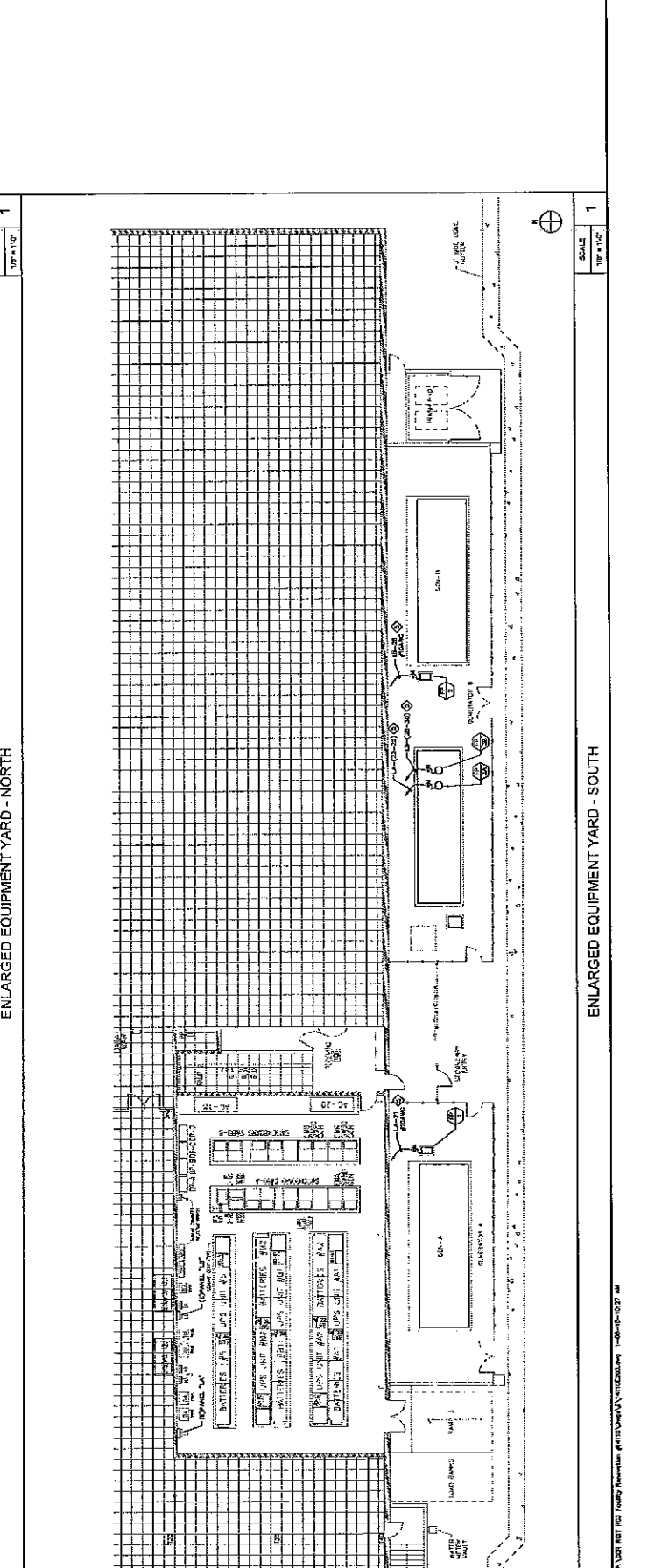
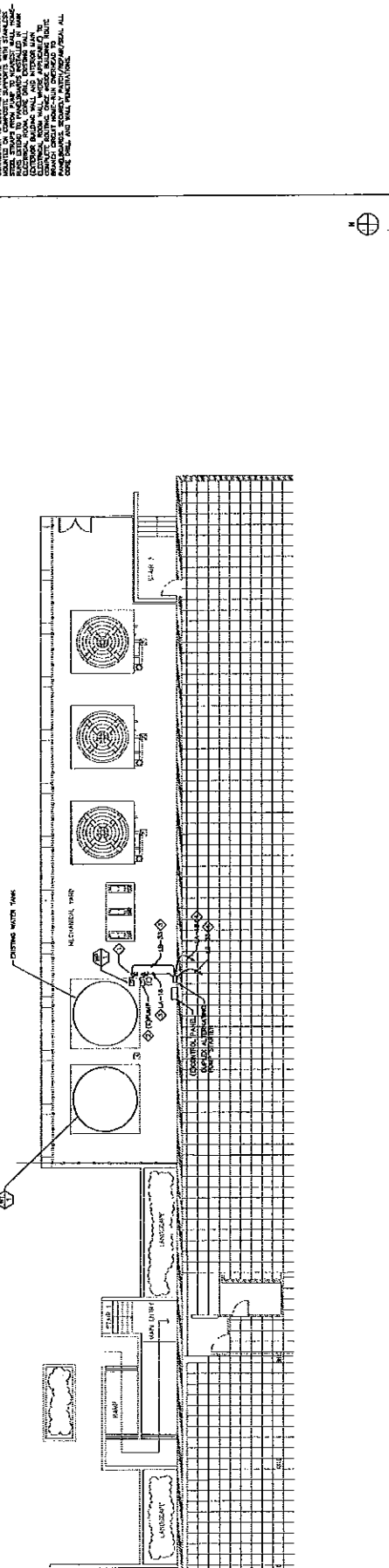





















NO.	DESCRIPTION	UNIT	QTY	UNIT PRICE	TOTAL PRICE	DATE	BY
1	...	...	...	...	...	...	...
2	...	...	...	...	...	...	...
3	...	...	...	...	...	...	...
4	...	...	...	...	...	...	...
5	...	...	...	...	...	...	...
6	...	...	...	...	...	...	...
7	...	...	...	...	...	...	...
8	...	...	...	...	...	...	...
9	...	...	...	...	...	...	...
10	...	...	...	...	...	...	...
11	...	...	...	...	...	...	...
12	...	...	...	...	...	...	...
13	...	...	...	...	...	...	...
14	...	...	...	...	...	...	...
15	...	...	...	...	...	...	...
16	...	...	...	...	...	...	...
17	...	...	...	...	...	...	...
18	...	...	...	...	...	...	...
19	...	...	...	...	...	...	...
20	...	...	...	...	...	...	...
21	...	...	...	...	...	...	...
22	...	...	...	...	...	...	...
23	...	...	...	...	...	...	...
24	...	...	...	...	...	...	...
25	...	...	...	...	...	...	...
26	...	...	...	...	...	...	...
27	...	...	...	...	...	...	...
28	...	...	...	...	...	...	...
29	...	...	...	...	...	...	...
30	...	...	...	...	...	...	...
31	...	...	...	...	...	...	...
32	...	...	...	...	...	...	...
33	...	...	...	...	...	...	...
34	...	...	...	...	...	...	...
35	...	...	...	...	...	...	...
36	...	...	...	...	...	...	...
37	...	...	...	...	...	...	...
38	...	...	...	...	...	...	...
39	...	...	...	...	...	...	...
40	...	...	...	...	...	...	...
41	...	...	...	...	...	...	...
42	...	...	...	...	...	...	...
43	...	...	...	...	...	...	...
44	...	...	...	...	...	...	...
45	...	...	...	...	...	...	...
46	...	...	...	...	...	...	...
47	...	...	...	...	...	...	...
48	...	...	...	...	...	...	...
49	...	...	...	...	...	...	...
50	...	...	...	...	...	...	...
51	...	...	...	...	...	...	...
52	...	...	...	...	...	...	...
53	...	...	...	...	...	...	...
54	...	...	...	...	...	...	...
55	...	...	...	...	...	...	...
56	...	...	...	...	...	...	...
57	...	...	...	...	...	...	...
58	...	...	...	...	...	...	...
59	...	...	...	...	...	...	...
60	...	...	...	...	...	...	...
61	...	...	...	...	...	...	...
62	...	...	...	...	...	...	...
63	...	...	...	...	...	...	...
64	...	...	...	...	...	...	...
65	...	...	...	...	...	...	...
66	...	...	...	...	...	...	...
67	...	...	...	...	...	...	...
68	...	...	...	...	...	...	...
69	...	...	...	...	...	...	...
70	...	...	...	...	...	...	...
71	...	...	...	...	...	...	...
72	...	...	...	...	...	...	...
73	...	...	...	...	...	...	...
74	...	...	...	...	...	...	...
75	...	...	...	...	...	...	...
76	...	...	...	...	...	...	...
77	...	...	...	...	...	...	...
78	...	...	...	...	...	...	...
79	...	...	...	...	...	...	...
80	...	...	...	...	...	...	...
81	...	...	...	...	...	...	...
82	...	...	...	...	...	...	...
83	...	...	...	...	...	...	...
84	...	...	...	...	...	...	...
85	...	...	...	...	...	...	...
86	...	...	...	...	...	...	...
87	...	...	...	...	...	...	...
88	...	...	...	...	...	...	...
89	...	...	...	...	...	...	...
90	...	...	...	...	...	...	...
91	...	...	...	...	...	...	...
92	...	...	...	...	...	...	...
93	...	...	...	...	...	...	...
94	...	...	...	...	...	...	...
95	...	...	...	...	...	...	...
96	...	...	...	...	...	...	...
97	...	...	...	...	...	...	...
98	...	...	...	...	...	...	...
99	...	...	...	...	...	...	...
100	...	...	...	...	...	...	...

NO.	DESCRIPTION	UNIT	QTY	UNIT PRICE	TOTAL PRICE	DATE	BY
1	...	...	...	...	...	...	...
2	...	...	...	...	...	...	...
3	...	...	...	...	...	...	...
4	...	...	...	...	...	...	...
5	...	...	...	...	...	...	...
6	...	...	...	...	...	...	...
7	...	...	...	...	...	...	...
8	...	...	...	...	...	...	...
9	...	...	...	...	...	...	...
10	...	...	...	...	...	...	...
11	...	...	...	...	...	...	...
12	...	...	...	...	...	...	...
13	...	...	...	...	...	...	...
14	...	...	...	...	...	...	...
15	...	...	...	...	...	...	...
16	...	...	...	...	...	...	...
17	...	...	...	...	...	...	...
18	...	...	...	...	...	...	...
19	...	...	...	...	...	...	...
20	...	...	...	...	...	...	...
21	...	...	...	...	...	...	...
22	...	...	...	...	...	...	...
23	...	...	...	...	...	...	...
24	...	...	...	...	...	...	...
25	...	...	...	...	...	...	...
26	...	...	...	...	...	...	...
27	...	...	...	...	...	...	...
28	...	...	...	...	...	...	...
29	...	...	...	...	...	...	...
30	...	...	...	...	...	...	...
31	...	...	...	...	...	...	...
32	...	...	...	...	...	...	...
33	...	...	...	...	...	...	...
34	...	...	...	...	...	...	...
35	...	...	...	...	...	...	...
36	...	...	...	...	...	...	...
37	...	...	...	...	...	...	...
38	...	...	...	...	...	...	...
39	...	...	...	...	...	...	...
40	...	...	...	...	...	...	...
41	...	...	...	...	...	...	...
42	...	...	...	...	...	...	...
43	...	...	...	...	...	...	...
44	...	...	...	...	...	...	...
45	...	...	...	...	...	...	...
46	...	...	...	...	...	...	...
47	...	...	...	...	...	...	...
48	...	...	...	...	...	...	...
49	...	...	...	...	...	...	...
50	...	...	...	...	...	...	...
51	...	...	...	...	...	...	...
52	...	...	...	...	...	...	...
53	...	...	...	...	...	...	...
54	...	...	...	...	...	...	...
55	...	...	...	...	...	...	...
56	...	...	...	...	...	...	...
57	...	...	...	...	...	...	...
58	...	...	...	...	...	...	...
59	...	...	...	...	...	...	...
60	...	...	...	...	...	...	...
61	...	...	...	...	...	...	...
62	...	...	...	...	...	...	...
63	...	...	...	...	...	...	...
64	...	...	...	...	...	...	...
65	...	...	...	...	...	...	...
66	...	...	...	...	...	...	...
67	...	...	...	...	...	...	...
68	...	...	...	...	...	...	...
69	...	...	...	...	...	...	...
70	...	...	...	...	...	...	...
71	...	...	...	...	...	...	...
72	...	...	...	...	...	...	...
73	...	...	...	...	...	...	...
74	...	...	...	...	...	...	...
75	...	...	...	...	...	...	...
76	...	...	...	...	...	...	...
77	...	...	...	...	...	...	...
78	...	...	...	...	...	...	...
79	...	...	...	...	...	...	...
80	...	...	...	...	...	...	...
81	...	...	...	...	...	...	...
82	...	...	...	...	...	...	...
83	...	...	...	...	...	...	...
84	...	...	...	...	...	...	...
85	...	...	...	...	...	...	...
86	...	...	...	...	...	...	...
87	...	...	...	...	...	...	...
88	...	...	...	...	...	...	...
89	...	...	...	...	...	...	...
90	...	...	...	...	...	...	...
91	...	...	...	...	...	...	...
92	...	...	...	...	...	...	...
93	...	...	...	...	...	...	...
94	...	...	...	...	...	...	...
95	...	...	...	...	...	...	...
96	...	...	...	...	...	...	...
97	...	...	...	...	...	...	...
98	...	...	...	...	...	...	...
99	...	...	...	...	...	...	...
100	...	...	...	...	...	...	...

NO.	DESCRIPTION	UNIT	QTY	UNIT PRICE	TOTAL PRICE	DATE	BY
1	...	...	...	...	...	...	...
2	...	...	...	...	...	...	...
3	...	...	...	...	...	...	...
4	...	...	...	...	...	...	...
5	...	...	...	...	...	...	...
6	...	...	...	...	...	...	...
7	...	...	...	...	...	...	...
8	...	...	...	...	...	...	...
9	...	...	...	...	...	...	...
10	...	...	...	...	...	...	...
11	...	...	...	...	...	...	...
12	...	...	...	...	...	...	...
13	...	...	...	...	...	...	...
14	...	...	...	...	...	...	...
15	...	...	...	...	...	...	...
16	...	...	...	...	...	...	...
17	...	...	...	...	...	...	...
18	...	...	...	...	...	...	...
19	...	...	...	...	...	...	...
20	...	...	...	...	...	...	...
21	...	...	...	...	...	...	...
22	...	...	...	...	...	...	...
23	...	...	...	...	...	...	...
24	...	...	...	...	...	...	...
25	...	...	...	...	...	...	...
26	...	...	...	...	...	...	...
27	...	...	...	...	...	...	...
28	...	...	...	...	...	...	...
29	...	...	...	...	...	...	...
30	...	...	...	...	...	...	...
31	...	...	...	...	...	...	...
32	...	...	...	...	...	...	...
33	...	...	...	...	...	...	...
34	...	...	...	...	...	...	...
35	...	...	...	...	...	...	...
36	...	...	...	...	...	...	...
37	...	...	...	...	...	...	...
38	...	...	...	...	...	...	...
39	...	...	...	...	...	...	...
40	...	...	...	...	...	...	...
41	...	...	...	...	...	...	...
42	...	...	...	...	...	...	...
43	...	...	...	...	...	...	...
44	...	...	...	...	...	...	...
45	...	...	...	...	...	...	...
46	...	...	...	...	...	...	...
47	...	...	...	...	...	...	...
48	...	...	...	...	...	...	...
49	...	...	...	...	...	...	...
50	...	...	...	...	...	...	...
51	...	...	...	...	...	...	...
52	...	...	...	...	...	...	...
53	...	...	...	...	...	...	...
54	...	...	...	...	...	...	...
55	...	...	...	...	...	...	...
56	...	...	...	...	...	...	...
57	...	...	...				





