

307A



**SUBMITTAL TO THE BOARD OF SUPERVISORS
COUNTY OF RIVERSIDE, STATE OF CALIFORNIA**

FORM APPROVED COUNTY COUNSEL
BY: GREGORY P. PRIAMOS DATE: 9/15/15

Departmental Concurrence

FROM: TLMA – Transportation Department

SUBMITTAL DATE:
September 3, 2015

SUBJECT: Accept the Low Bid and Award the Contract for the Construction of the El Cerrito, Hemet, and Perris Maintenance Yards Pavement Resurfacing Project. 2nd, 3rd, and 5th Districts; [\$361,156]; Local Funds 100%

RECOMMENDED MOTION: That the Board of Supervisors:

1. Approve one addendum to the specifications issued prior the August 5, 2015, bid opening; and
2. Accept the low bid of All American Asphalt of Corona, CA in the amount of \$361,156; and
3. Award the contract to All American Asphalt and authorize the Chairman of the Board to execute the contract documents; and
4. Approve the project's proposed budget as shown on Attachment "A."

Patricia Romo
Assistant Director of Transportation

Juan C. Perez
Director of Transportation and Land Management

FINANCIAL DATA	Current Fiscal Year:	Next Fiscal Year:	Total Cost:	Ongoing Cost:	POLICY/CONSENT (Per Exec. Office)
COST	\$ 361,156	\$ 0	\$ 361,156	\$ 0	Consent <input type="checkbox"/> Policy <input checked="" type="checkbox"/>
NET COUNTY COST	\$ 0	\$ 0	\$ 0	\$ 0	

SOURCE OF FUNDS: Gas Tax-Prop 111 (100%). There are no General Funds used in this project.

Budget Adjustment: No
For Fiscal Year: 15/16

C.E.O. RECOMMENDATION:

APPROVE

BY:
Rohini Dasika

County Executive Office Signature

MINUTES OF THE BOARD OF SUPERVISORS

- A-30
- 4/5 Vote
- Positions Added
- Change Order

Prev. Agn. Ref.: 6/30/15, Item 3-63

District: 2, 3, 5

Agenda Number:

3-50

SUBMITTAL TO THE BOARD OF SUPERVISORS, COUNTY OF RIVERSIDE, STATE OF CALIFORNIA
FORM 11: Accept the Low Bid and Award the Contract for the Construction of the El Cerrito, Hemet, and Perris Maintenance Yards Pavement Resurfacing Project. 2nd, 3rd, and 5th Districts; [\$361,156]; Local Funds 100%
DATE: September 3, 2015
PAGE: 2 of 3

BACKGROUND:

Summary

By Minute Order dated June 30, 2015 (Agenda Item 3-63), the Board of Supervisors authorized the Clerk of the Board to advertise for the pavement resurfacing of three Transportation Department maintenance yards located in El Cerrito, Hemet, and Perris.

The environmental clearance for the project has been documented by the Notice of Exemption, which was approved by the Board of Supervisors on June 30, 2015 (Agenda Item 3-63).

The resurfacing work consists of grinding the existing asphalt concrete pavement to remove up to three inches, grading the site and compacting the existing subgrade, and resurfacing with new hot mix asphalt. The resurfacing work will be limited to the existing paved parking areas.

During the advertisement period, one addendum was issued to all registered plan holders as a supplement to the specifications. Bidders were required to acknowledge and take into account the issued addendum on their Contractor's Bid in order to be considered for award. The addendum was issued to clarify and modify the approved contract documents. The addendum is attached and designated as Addendum Number 1.

The construction contract includes the following schedules of work:

Base Bid Schedule:	Resurfacing of three maintenance yards
Alternate Bid Schedule 1:	Additional area to resurface at El Cerrito Maintenance Yard
Alternate Bid Schedule 2:	Additional area to resurface at Perris Maintenance Yard

The contractor is qualified to perform the work as outlined in the bid, has executed the contract, and has provided bonds and insurance documents, which meet the requirements of the contract.

Project Number: 15-00008

Impact on Residents and Businesses

The proposed improvements will improve surface drainage and benefit the project area by significantly increasing the service life of the existing infrastructure and provide a safer paved surface to the Transportation Department's Operation and Maintenance staff.

The construction work will take approximately three weekends to complete and will be phased to keep the maintenance yard locations open during construction, continuing to service public needs.

SUPPLEMENTAL:

Additional Fiscal Information

The contract is recommended to be awarded to All American Asphalt for the total amount of \$361,156. The project is funded with Gas Tax.

There are no General Funds used in this project.

Contract History and Price Reasonableness

Seven bids were received on August 5, 2015, ranging from \$361,156 to \$622,400. The bid received from Jacobsson Engineering Construction, Inc. (Jacobsson) was found to be nonresponsive due to the missing bid price for bid items 9, 10, and 11. Jacobsson was notified by a letter dated August 7, 2015. A copy of the letter is attached herewith. Their bid was the sixth highest in bid price ranking.

SUBMITTAL TO THE BOARD OF SUPERVISORS, COUNTY OF RIVERSIDE, STATE OF CALIFORNIA
FORM 11: Accept the Low Bid and Award the Contract for the Construction of the El Cerrito, Hemet, and Perris Maintenance Yards Pavement Resurfacing Project. 2nd, 3rd, and 5th Districts; [\$361,156]; Local Funds 100%
DATE: September 3, 2015
PAGE: 3 of 3

The basis for the selection of a contractor is the lowest responsive and responsible bid. The lowest responsible bid was submitted by All American Asphalt in the amount of \$361,156, which is \$61,104 (14%) lower than the Engineer's Estimate.

ATTACHMENTS

- Vicinity Maps
- Attachment A
- Contract/Lease/Purchase Summary Data
- Summary of Bids
- Addendum Number 1 w/Letter to Jacobsson Engineering Construction, Inc.
- Contract

Bid

Date: 7/8/15

To: County of Riverside, hereafter called "County";

Bidder: All American Asphalt
(hereafter called "Contractor")

The undersigned, Contractor, having carefully examined the site and the Contract Documents for the construction of El Cerrito, Hemet and Perris Maintenance Yards Pavement Resurfacing Projects, Project No. 15-00008 hereby proposes to construct the work in accordance with the Contract Documents, including Addenda Number(s) 1 (Fill in addenda numbers if addenda have been issued.) for the amount stated in this Bid.

By submitting this Bid, Contractor agrees with County:

1. That unless withdrawn in person by Contractor or some person authorized in writing by Contractor (not by telephone or facsimile) before the time specified in the Notice Inviting Bids for the public opening of bids, this Bid constitutes an irrevocable offer for 90 calendar days after that date.
2. County has the right to reject any or all Bids and to waive any irregularities or informalities contained in a Bid.
3. To execute the Contract and deliver the Performance Bond, Payment Bond and Insurance Certificate with endorsements, that comply with the requirements set forth in the Instruction to Bidders and General Conditions within ten (10) business days of the date of the Notice of Acceptance of Bid and Intent to Award as issued by the County.
4. That the contract shall be awarded upon a resolution or minute order to that effect duly adopted by the governing body of County; and that execution of the Contract shall constitute a written memorial thereof.
5. To submit to the County such information as County may require determining whether a particular Bid is the lowest responsible bid submitted.
6. That the accompanying Bid Bond, certified check or cashier's check is in an amount not less than 10% of the total bid submitted and constitutes a guarantee that if awarded the contract, Contractor will execute the Contract and deliver the required bonds within ten (10) business days after notice of award. If Contractor fails to execute and deliver said documents, the bond or check is to be charged with the costs of the resultant damages to the County, including but not limited to: publication costs, the difference in money between the amount bid and the amount in excess of the bid which it costs County to do or cause to be done for the work involved, lease and rental costs, additional salaries and overhead, increased interest and costs of funding the project, attorney expense, additional engineering and architectural expense and cost of maintaining or constructing alternate facilities occasioned by the failure to execute and deliver said documents.
7. By signing this Bid the Contractor certifies that the representations made therein are made under penalty of perjury.

**El Cerrito, Hemet and Perris
Maintenance Yards Pavement Resurfacing Projects**

Project No. 15-00008

Attachment A
Issued By: Addendum 1

PROPOSAL(REVISED)

ITEM No.	ITEM CODE	ITEM	UNIT	ESTIMATED QUANTITY	ITEM PRICE (IN FIGURES)	TOTAL (IN FIGURES)
BASE BID						
1	066102	DUST ABATEMENT	LS	1	1000 -	1000 -
2	074020	WATER POLLUTION CONTROL	LS	1	5000 -	5000 -
3	150857	REMOVE ASPHALT CONCRETE SURFACING	LS	1	71000 -	71000 -
4	390130	HOT MIX ASPHALT	TON	2,800	66 -	184800 -
5	010602	MISCELLANEOUS WORK (AS DIRECTED)	FA	1	10,000.00	10,000.00
5A	013903	PLACE ASPHALT CONCRETE DIKE (CRS 212) (6")	LF	220	8.20	1804 -

BASE BID ITEMS 1-5A two hundred seventy four thousand two hundred \$ 274,204.00
four four Dollars. "WORDS"
 EC

ALTERNATE BID SCHEDULE 1 (EL CERRITO MAINTENANCE YARD)

6	074020	WATER POLLUTION CONTROL	LS	1	1000 -	1000 -
7	150857	REMOVE ASPHALT CONCRETE SURFACING	LS	1	13500 -	13500 -
8	390130	HOT MIX ASPHALT	TON	562	70 -	39340 -
8A	013903	PLACE ASPHALT CONCRETE DIKE (CRS 212) (6")	LF	260	8.20	2132 -

ALT. BID SCH. 1 ITEMS 6-8A forty six thousand five hundred seventy two Dollars \$ 50,572.00
 "WORDS"

ALTERNATE BID SCHEDULE 2 (PERRIS MAINTENANCE YARD)

9	074020	WATER POLLUTION CONTROL	LS	1	1000 -	1000 -
10	150857	REMOVE ASPHALT CONCRETE SURFACING	LS	1	6800 -	6800 -
11	390130	HOT MIX ASPHALT	TON	314	70 -	21980 -

ALT. BID SCH. 2 ITEMS 9-11 thirty thousand three hundred eighty Dollars \$ 30,380 -
 "WORDS"

PROJECT TOTAL ITEMS 1-11 three hundred sixty one thousand one hundred \$ 361,156.00
fifty six Dollars "WORDS"

Bidder Data and Signature

Name of Bidder: All American Asphalt

Type of organization: Corporation

Person(s) authorized to sign for Bidder: Mark Luer, President

Edward J. Carlson, Vice President

Michael Farkas, Secretary

Note:

If Bidder is a Corporation, state legal name of Corporation and also names of the president, vice-president, secretary, treasurer and manager thereof.

If Bidder is a Co-Partnership, state true name of firm and also names of all individual co-partners composing firm.

If Bidder is a sole proprietorship or an Individual, state first and last name(s) in full.

If Bid is signed by an agent other than an owner, partner or corporate officer, Bid shall be accompanied by a power-of-attorney.

Business Street Address: 400 East Sixth Street
(Please include business address even if P.O. Box is used.)

Business City, State, Zip Code: Corona, CA 92878

P.O. Box- Number: P.O. Box 2229

P.O. Box- City, State, Zip Code: Corona, CA 92878

Phone: (951) 736-7600

Facsimile: (951) 736-7646

E-mail: publicworks@allamericanasphalt.com

Contractor's license number: 267073

License Classification(s): A, C-12

Expiration date: 1/31/2016

Department of Industrial Relations Registration Number: 1000001051

Bidder Data and Signature (continued)

Accompanying this Bid is a certified check, cashier check or bid bond in an amount equal to at least ten (10) percent of the total bid for:

**El Cerrito, Hemet and Perris
Maintenance Yards Pavement Resurfacing Project
Project No. 15-00008**

By my signature on this Bid, I certify, under penalty of perjury under the laws of the State of California, that all the information on this form is true and correct.

IN WITNESS WHERE OF Bidder/Contractor executed this Bid as of the date set forth on page B1 of this Bid.

Signature:



Name (printed):

Edward J. Carlson, Vice President

Title:

All American Asphalt
"Contractor"

Subcontractor List

Bidder/Contractor submits the following complete list of each Subcontractor who will perform work, labor or render service in or about the construction in an amount in excess of 1/2 of 1% of the total bid or \$10,000 whichever is greater.

Check box on right side of row if any construction item, for the listed Subcontractor, is partial work. If partial work is to be performed within a certain construction item or trade, the Bidder/Contractor shall specify the portion(s) of the work to be performed by the different subcontractors or Bidder/Contractor will be subject to provisions of Public Contract Code Section 4106.

Name of Bidder (Prime/General Contractor): All American Asphalt

	Subcontractor Name	License Number	DIR Registration Number	Business Address (City, State)	Construction Item(s) [Item Number and Description]	Check if Partial Work
1.	NONE					<input type="checkbox"/>
2.						<input type="checkbox"/>
3.						<input type="checkbox"/>
4.						<input type="checkbox"/>
5.						<input type="checkbox"/>
6.						<input type="checkbox"/>
7.						<input type="checkbox"/>

(if applicable, check box.) Additional information for Subcontractor List is attached to this Bid. (A copy of this form may be attached with additional Subcontractor information.)

Percent of work to be performed by Subcontractors: _____%

Note: A minimum of 50% of the work is required to be performed by the prime/general Contractor.

Non-Collusion Declaration

To be executed by bidder and submitted with bid.
(Title 23 United States Code Section 112 and Public Contract Code Section 7106)

The undersigned declares:

I am the Vice President (Title) of All American Asphalt (Company),
the party making the foregoing bid.

The bid is not made in the interest of, or on behalf of, any undisclosed person, partnership, company, association, organization, or corporation. The bid is genuine and not collusive or sham. The bidder has not directly or indirectly induced or solicited any other bidder to put in a false or sham bid. The bidder has not directly or indirectly colluded, conspired, connived, or agreed with any bidder or anyone else to put in a sham bid, or that anyone shall refrain from bidding. The bidder has not in any manner, directly or indirectly, sought by agreement, communication, or conference with anyone to fix the bid price of the bidder or any other bidder, or to fix any overhead, profit, or cost element of the bid price, or of that of any other bidder.

All statements contained in the bid are true. The bidder has not, directly or indirectly, submitted his or her bid price of any breakdown thereof, or the contents thereof, or divulged information or data relative thereto, to any corporation, partnership, company, association, organization, bid depository, or to any member or agent thereof to effectuate a collusive or sham bid, and has not paid, and will not pay, any person or entity for such purpose.

Any person executing this declaration on behalf of a bidder that is a corporation, partnership, joint venture, limited liability company, limited liability partnership, or any other entity, hereby represents that he or she has full power to execute, and does execute, this declaration on behalf of the bidder.

I declare under penalty of perjury under the applicable laws that the foregoing is true and correct and that this declaration is executed on

July (Month) 08 (Day) of 2015 (Year),
at Corona (City), CA (State).

Signature of Declarant:



Printed name of Declarant: Edward J. Carlson, Vice President

Name of Bidder (Company): All American Asphalt

Title or Office: Corporation

Note: Notarization of signature required.
 Check box if attachment is included.

CALIFORNIA ALL-PURPOSE ACKNOWLEDGEMENT

CIVIL CODE § 1189

A notary public or other officer completing this certificate verifies only the identity of the individual who signed the document to which this certificate is attached, and not the truthfulness, accuracy, or validity of that document.

State of California

County of Riverside

On 7/08/2015 before me, Rebecca Angela Parra, Notary Public
Date Here Insert name and Title of the Officer

personally appeared Edward J. Carlson
Name(s) of Signer(s)

who proved to me on the basis of satisfactory evidence to be the person(s) whose name(s) is/are subscribed to the within instrument and acknowledged to me that he/she/they executed the same in his/her/their authorized capacity(ies), and that by his/her/their signature(s) on the instrument the person(s), or the entity upon behalf of which the person(s) acted, executed the instrument.

I certify under PENALTY OF PERJURY under the laws of the State of California that the foregoing paragraph is true and correct.

WITNESS my hand and official seal.



Place Notary Seal Above

Signature Rebecca Angela Parra
Signature of Notary Public

OPTIONAL

Though the information below is not required by law, it may prove valuable to person relying on the document and could prevent fraudulent removal and reattachment of this form to another document.

Description of Attached Document

Title or Type of Document Non Collusion Declaration

Document Date: 7/08/2015 Number of Pages: One (1)

Signer(s) Other Than Named Above: None

Capacity(ies) Claimed by Signer(s)

Signer's Name: Edward J. Carlson

- Individual
- X Corporate Officer — Title(s): Vice President
- Partner Limited General
- Attorney in Fact
- Trustee
- Other: _____

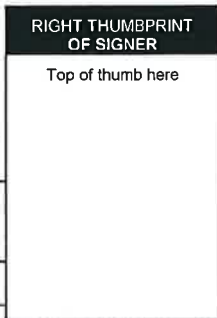

Signer is Representing:
All American Asphalt

Signer's Name: _____

- Individual
- Corporate Officer — Title(s): _____
- Partner Limited General
- Attorney in Fact
- Trustee
- Other: _____

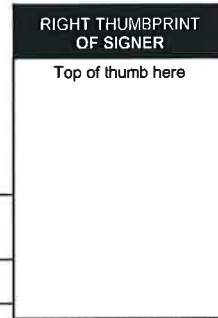

Signer is Representing: _____

Iran Contracting Act
(Public Contract Code sections 2200-2208)

Prior to bidding on, submitting a proposal or executing a contract or renewal for a County of Riverside contract for goods or services of \$1,000,000 or more, a Contractor must either:

- a) Certify it is not on the current list of persons engaged in investment activities in Iran created by the California Department of General Services ("DGS") pursuant to Public Contract Code section 2203(b) and is not a financial institution extending twenty million dollars (\$20,000,000) or more in credit to another person, for 45 days or more, if that other person will use the credit to provide goods or services in the energy sector in Iran and is identified on the current list of persons engaged in investment activities in Iran created by DGS; or
- b) Demonstrate it has been exempted from the certification requirement for that solicitation or contract pursuant to Public Contract Code section 2203(c) or (d).

To comply with this requirement, please insert your Contractor or financial institution name and Federal ID Number (if available) and complete one of the options below. Please note: California law establishes penalties for providing false certifications, including civil penalties equal to the greater of \$250,000 or twice the amount of the contract for which the false certification was made; contract termination; and three-year ineligibility to bid on contracts. (Public Contract Code section 2205.)

Option #1 – Certification

I, the official named below, certify I am duly authorized to execute this certification on behalf of the vendor/financial institution identified below, and the vendor/financial institution identified below is not on the current list of persons engaged in investment activities in Iran created by DGS and is not a financial institution extending twenty million dollars (\$20,000,000) or more in credit to another person/vendor, for 45 days or more, if that other person/vendor will use the credit to provide goods or services in the energy sector in Iran and is identified on the current list of persons engaged in investment activities in Iran created by DGS.

<i>Contractor Name/Financial Institution (Printed)</i> All American Asphalt		<i>Federal ID Number (or n/a)</i> 95-2595043
<i>By (Authorized Signature)</i> 		
<i>Printed Name and Title of Person Signing</i> Edward J. Carlson, Vice President		
<i>Date Executed</i> 7/3/15	<i>Executed in</i> Corona, CA	

Option #2 – Exemption

Pursuant to Public Contract Code sections 2203(c) and (d), a public entity may permit a Contractor/financial institution engaged in investment activities in Iran, on a case-by-case basis, to be eligible for, or to bid on, submit a proposal for, or enters into or renews, a contract for goods and services.

If you have obtained an exemption from the certification requirement under the Iran Contracting Act, please fill out the information below, and attach documentation demonstrating the exemption approval.

<i>Contractor Name/Financial Institution (Printed)</i>		<i>Federal ID Number (or n/a)</i>
<i>By (Authorized Signature)</i>		
<i>Printed Name and Title of Person Signing</i>		
<i>Date Executed</i>	<i>Executed in</i>	

Addendum No.1
El Cerrito, Hemet and Perris Maintenance Yards
Pavement Resurfacing Project
Project No. 15-00008
July 29, 2015
Page 6 of 7

This addendum has been prepared under the direction of the following registered Civil Engineer(s):

D. Kelley Donovan, P.E.

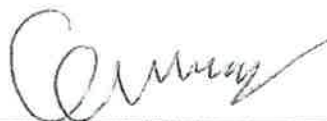

Concurrence:

 7/29/15
Khalid Nasim, P.E.
Engineering Division Manager

Acknowledged:   Date: 7/29/15
(Contractor)
JRJ:jrj:sb Edward J. Carlson, Vice President

Note: Refer to Section 8, "Addenda" (page A4). Submission of all addendum pages and non-bidding document attachments of addendum are not necessary for Bid submittal. Submittal of **only this acknowledgement page** is adequate for Bid reception. Bidders are reminded to list addendum number(s) received on the first page (B1) of the Bid form (Proposal).



COUNTY OF RIVERSIDE
Transportation and Land Management Agency
TRANSPORTATION DEPARTMENT

Fax Transmittal

July 29, 2015

TO: Plan Holders and Plan Rooms

FROM: Joel Jimenez
Contracts and Utilities Unit
Voice: (951)955-1537 Fax: (951)955-3164
Email: jrjimenez@rctlma.org
<http://rctlma.org/trans/Contractors-Corner/Notices-Inviting-Bids>

RE: Transmittal of Addendum No. 1
El Cerrito, Hemet and Perris
Maintenance Yards Pavement Resurfacing Project
Project No. 15-00008

Number of Pages transmitted: 10 (Including Cover Sheet)

Transmitted is addendum No. 1 to the referenced public works project

**IMPORTANT: CALL US AT (951) 955-6780
TO ACKNOWLEDGE YOUR RECEIPT OF
THE ADDENDUM. THANK YOU.**

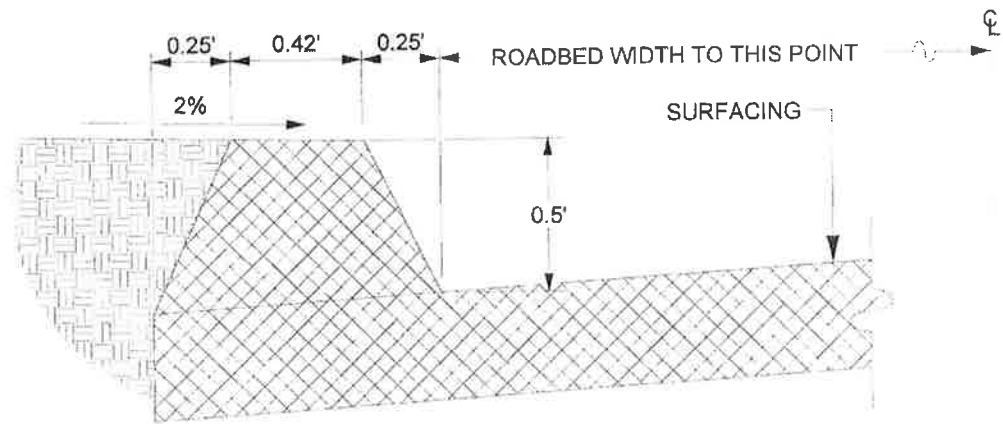

6" A.C. DIKE

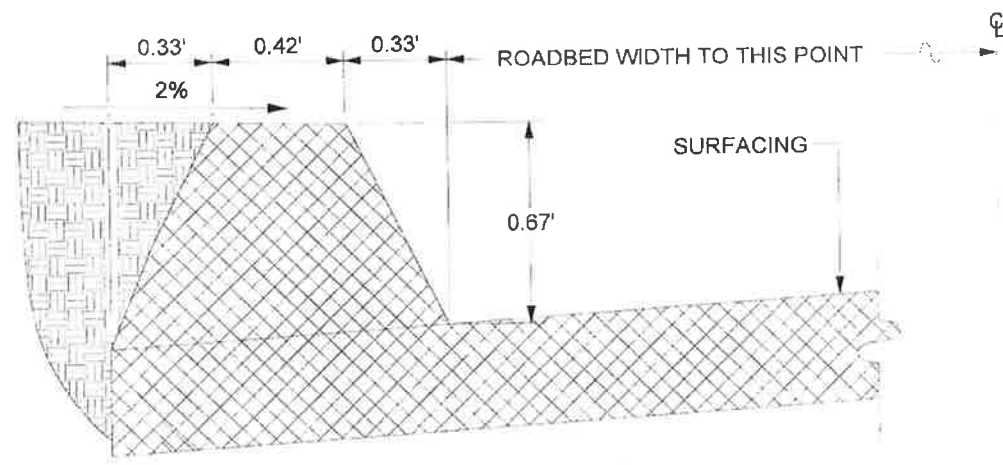

8" A.C. DIKE

NOT TO SCALE

NOTE: A.C. DIKE REQUIRED WHERE FILL SLOPES ARE STEEPER THAN 4:1, MATERIAL IS SUSCEPTIBLE TO EROSION, OR WHERE ROADWAY GRADIENT EXCEEDS 3%.

APPROVED BY:

 DIRECTOR OF TRANSPORTATION
 GEORGE A. JOHNSON, RCE 42328

DATE: 05/01/07



COUNTY OF RIVERSIDE

**ASPHALT CONCRETE
 DIKES**

REVISIONS	REV.	BY:	APR'D	DATE	REV.	BY:	APR'D	DATE
	1				4			
	2				5			
	3				6			

STANDARD NO. 212

Bid Bond

Recitals:

1. All American Asphalt "Contractor", has submitted his/her Contractor's Proposal to County of Riverside, "County", for the construction of public work for El Cerrito, Hemet and Perris Maintenance Yards Pavement Resurfacing Project, Project No. 15-00008 in accordance with a Notice Inviting Bids from the County.
2. Fidelity and Deposit Company of Maryland a Maryland corporation, hereafter called "Surety", is the surety of this bond.

Agreement:

We, Contractor as Principal and Surety as Surety, jointly and severally agree and state as follows:

1. The amount of the obligation of this bond is 10% of the amount of the Contractor's Proposal, including bid alternates, and inures to the benefit of County.
2. This Bond is exonerated by (1) County rejecting said Proposal or, in the alternate, (2) if said Proposal is accepted, Contractor executes the Contract and furnishes the Bonds as agreed to in its Proposal, otherwise it remains in full force and effect for the recovery of loss, damage and expense of County resulting from failure of Contractor to act as agreed to in its Proposal. Some types of possible loss, damage and expense are specified in the Contractor's Proposal.
3. Surety, for value received, stipulates and agrees that its obligations hereunder shall in no way be impaired or affected by any extension of time within which County may accept the Proposal and waives notice of any such extension.
4. This Bond is binding on our heirs, executors, administrators, successors and assigns.

Dated: July 6, 2015

Signatures:

Fidelity and Deposit Company of Maryland

All American Asphalt

By: Rebecca Haas-Bates
Rebecca Haas-Bates

By: Edward J. Carlson

Title: Attorney in Fact
"Surety"

Title: Edward J. Carlson, Vice President
"Contractor"

STATE OF **Please See Attached**
COUNTY _____
OF _____

} ss. SURETY'S ACKNOWLEDGEMENT

On _____ before me, _____
personally appeared, _____ known to me, or proved to me on the basis of
satisfactory evidence, to be the person whose name is subscribed to the within instrument and acknowledged
to me that he/she executed the same in his/her authorized capacities, and that by his/her signature on the
instrument the person, or the entity upon behalf of which the person acted, executed the instrument.

WITNESS my hand and official seal.

Signature of Notary Public

Notary Public (Seal)

Note: This Bond must be executed by both Contractor and Surety with corporate seal affixed. All
signatures must be notarized. (Attach acknowledgements).

CALIFORNIA ALL-PURPOSE ACKNOWLEDGEMENT

CIVIL CODE § 1189

A notary public or other officer completing this certificate verifies only the identity of the individual who signed the document to which this certificate is attached, and not the truthfulness, accuracy, or validity of that document.

State of California

County of Riverside

On 7/08/2015 before me, Rebecca Angela Parra, Notary Public
Date Here insert name and Title of the Officer

personally appeared Edward J. Carlson
Name(s) of Signer(s)



who proved to me on the basis of satisfactory evidence to be the person(s) whose name(s) is/are subscribed to the within instrument and acknowledged to me that he/she/they executed the same in his/her/their authorized capacity(ies), and that by his/her/their signature(s) on the instrument the person(s), or the entity upon behalf of which the person(s) acted, executed the instrument.

I certify under PENALTY OF PERJURY under the laws of the State of California that the forgoing paragraph is true and correct.

WITNESS my hand and official seal.

Signature Rebecca Angela Parra
Signature of Notary Public

Place Notary Seal Above

OPTIONAL

Though the information below is not required by law, it may prove valuable to person relying on the document and could prevent fraudulent removal and reattachment of this form to another document.

Description of Attached Document

Title or Type of Document Bid Bond

Document Date: 7/06/2015 Number of Pages: One (1)

Signer(s) Other Than Named Above: Fidelity and Deposit Company of Maryland

Capacity(ies) Claimed by Signer(s)

Signer's Name: Edward J. Carlson

- Individual
- Corporate Officer — Title(s): Vice President
- Partner Limited General
- Attorney in Fact
- Trustee
- Other: _____

RIGHT THUMBPRINT OF SIGNER

Top of thumb here

Signer is Representing:
All American Asphalt

Signer's Name: _____

- Individual
- Corporate Officer — Title(s): _____
- Partner Limited General
- Attorney in Fact
- Trustee
- Other: _____

RIGHT THUMBPRINT OF SIGNER

Top of thumb here

Signer is Representing: _____

CALIFORNIA ALL-PURPOSE ACKNOWLEDGMENT

CIVIL CODE § 1189

A notary public or other officer completing this certificate verifies only the identity of the individual who signed the document to which this certificate is attached, and not the truthfulness, accuracy, or validity of that document.

State of California)
County of Orange)

On 07/06/2015 before me, R. Paramo, Notary Public
Date Here Insert Name and Title of the Officer

personally appeared Rebecca Haas-Bates
Name(s) of Signer(s)

who proved to me on the basis of satisfactory evidence to be the person(s) whose name(s) is/are subscribed to the within instrument and acknowledged to me that he/she/they executed the same in his/her/their authorized capacity(ies), and that by his/her/their signature(s) on the instrument the person(s), or the entity upon behalf of which the person(s) acted, executed the instrument.

I certify under PENALTY OF PERJURY under the laws of the State of California that the foregoing paragraph is true and correct.

WITNESS my hand and official seal.

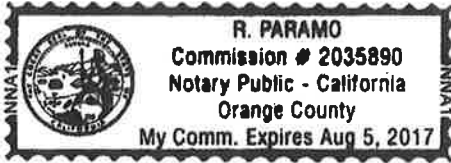

Signature [Signature]
Signature of Notary Public

Place Notary Seal Above

OPTIONAL

Though this section is optional, completing this information can deter alteration of the document or fraudulent reattachment of this form to an unintended document.

Description of Attached Document

Title or Type of Document: Bid Bond Document Date: 07/06/2015
Number of Pages: One (1) Signer(s) Other Than Named Above: All American Asphalt

Capacity(ies) Claimed by Signer(s)

Signer's Name: Rebecca Haas-Bates
 Corporate Officer — Title(s): _____
 Partner — Limited General
 Individual Attorney in Fact
 Trustee Guardian or Conservator
 Other: _____
Signer Is Representing: _____
Fidelity and Deposit Company of Maryland

Signer's Name: _____
 Corporate Officer — Title(s): _____
 Partner — Limited General
 Individual Attorney in Fact
 Trustee Guardian or Conservator
 Other: _____
Signer Is Representing: _____

EXTRACT FROM BY-LAWS OF THE COMPANIES

"Article V, Section 8, Attorneys-in-Fact. The Chief Executive Officer, the President, or any Executive Vice President or Vice President may, by written instrument under the attested corporate seal, appoint attorneys-in-fact with authority to execute bonds, policies, recognizances, stipulations, undertakings, or other like instruments on behalf of the Company, and may authorize any officer or any such attorney-in-fact to affix the corporate seal thereto; and may with or without cause modify or revoke any such appointment or authority at any time."

CERTIFICATE

I, the undersigned, Vice President of the ZURICH AMERICAN INSURANCE COMPANY, the COLONIAL AMERICAN CASUALTY AND SURETY COMPANY, and the FIDELITY AND DEPOSIT COMPANY OF MARYLAND, do hereby certify that the foregoing Power of Attorney is still in full force and effect on the date of this certificate; and I do further certify that Article V, Section 8, of the By-Laws of the Companies is still in force.

This Power of Attorney and Certificate may be signed by facsimile under and by authority of the following resolution of the Board of Directors of the ZURICH AMERICAN INSURANCE COMPANY at a meeting duly called and held on the 15th day of December 1998.

RESOLVED: "That the signature of the President or a Vice President and the attesting signature of a Secretary or an Assistant Secretary and the Seal of the Company may be affixed by facsimile on any Power of Attorney...Any such Power or any certificate thereof bearing such facsimile signature and seal shall be valid and binding on the Company."

This Power of Attorney and Certificate may be signed by facsimile under and by authority of the following resolution of the Board of Directors of the COLONIAL AMERICAN CASUALTY AND SURETY COMPANY at a meeting duly called and held on the 5th day of May, 1994, and the following resolution of the Board of Directors of the FIDELITY AND DEPOSIT COMPANY OF MARYLAND at a meeting duly called and held on the 10th day of May, 1990.

RESOLVED: "That the facsimile or mechanically reproduced seal of the company and facsimile or mechanically reproduced signature of any Vice-President, Secretary, or Assistant Secretary of the Company, whether made heretofore or hereafter, wherever appearing upon a certified copy of any power of attorney issued by the Company, shall be valid and binding upon the Company with the same force and effect as though manually affixed.

IN TESTIMONY WHEREOF, I have hereunto subscribed my name and affixed the corporate seals of the said Companies, this 6th day of July, 2015.



Geoffrey Delisio

Geoffrey Delisio, Vice President



- Company Profile
- Company Search
- Company Search Results
- Company Information
- Old Company Names
- Agent for Service
- Reference Information
- NAIC Group List
- Lines of Business
- Workers' Compensation
- Complaint and Request for Action/Appeals
- Contact Information
- Financial Statements PDF's
- Annual Statements
- Quarterly Statements
- Company Complaint
- Company Performance & Comparison Data
- Company Enforcement Action
- Composite Complaints Studies
- Additional Info
- Find A Company Representative In Your Area
- View Financial Disclaimer

COMPANY PROFILE

Company Information

FIDELITY AND DEPOSIT COMPANY OF MARYLAND
1400 AMERICAN LANE, 19TH FLOOR
SCHUAMBURG, IL 60196-1056
800-382-2150

Old Company Names

Effective Date

Agent For Service

KARISSA LOWRY
 C/O CORPORATION SERVICE COMPANY
 2710 GATEWAY OAKS DRIVE, SUITE 150N
 SACRAMENTO CA 95833

Reference Information

NAIC #:	39306
California Company ID #:	2479-4
Date Authorized in California:	01/01/1982
License Status:	UNLIMITED-NORMAL
Company Type:	Property & Casualty
State of Domicile:	MARYLAND

back to top

NAIC Group List

NAIC Group #: 0212 ZURICH INS GRP

Lines Of Business

The company is authorized to transact business within these lines of insurance. For an explanation of any of these terms, please refer to the glossary.

- AIRCRAFT
- AUTOMOBILE
- BOILER AND MACHINERY
- BURGLARY
- CREDIT
- FIRE
- LIABILITY
- MARINE
- MISCELLANEOUS
- PLATE GLASS
- SPRINKLER
- SURETY
- TEAM AND VEHICLE
- WORKERS' COMPENSATION

back to top

COUNTY OF RIVERSIDE
TRANSPORTATION DEPARTMENT

EL CERRITO COUNTY YARD

RESURFACING

CORONA

PROJECT No. 15-00008

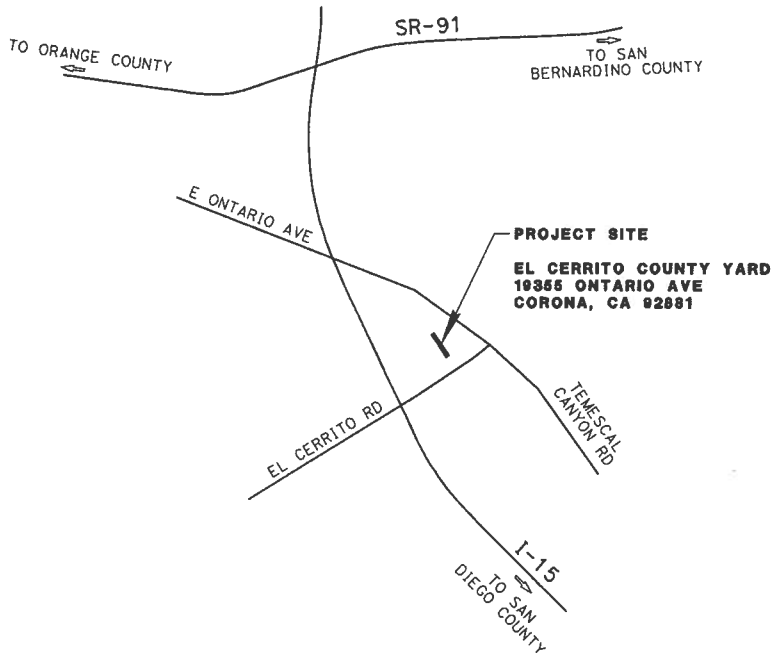
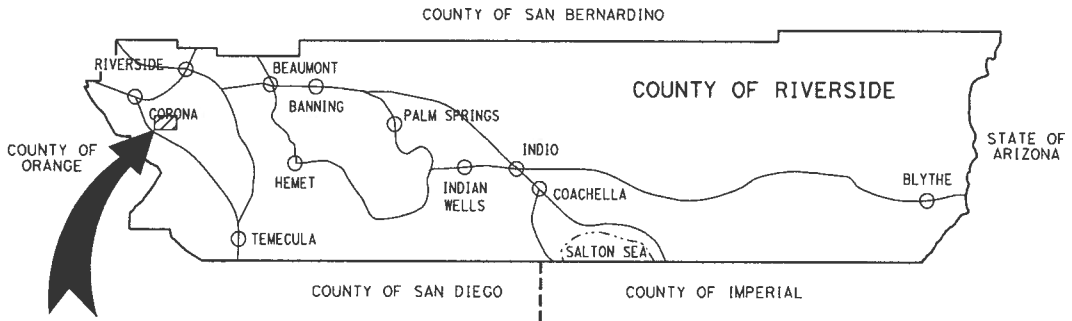

VICINITY MAP

TOWNSHIP 48 RANGE 6W SECTION 8
COUNTY ROAD BOOK PAGE No. 308

COUNTY OF RIVERSIDE
TRANSPORTATION DEPARTMENT

HEMET COUNTY YARD

RESURFACING

HEMET

PROJECT No. 15-00008

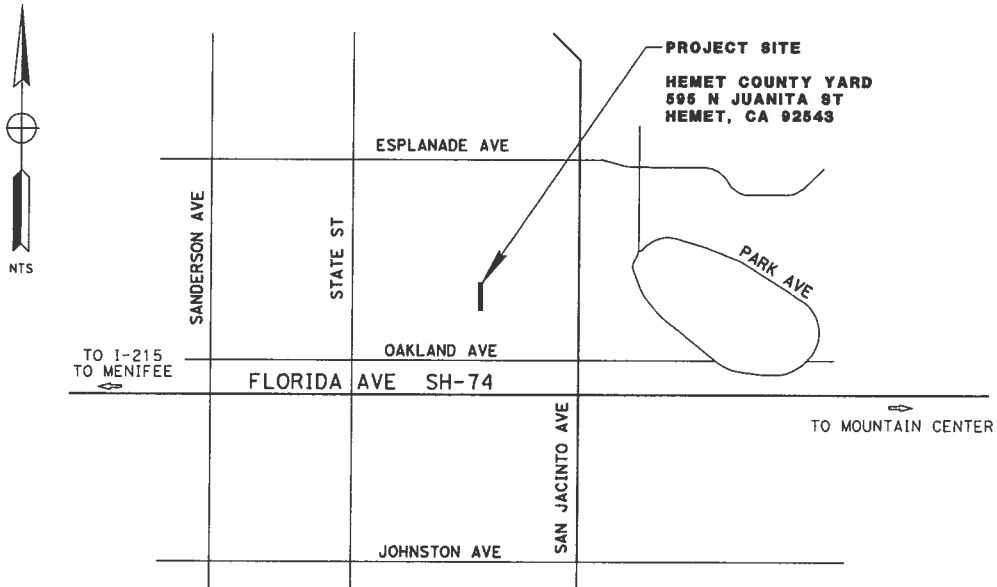
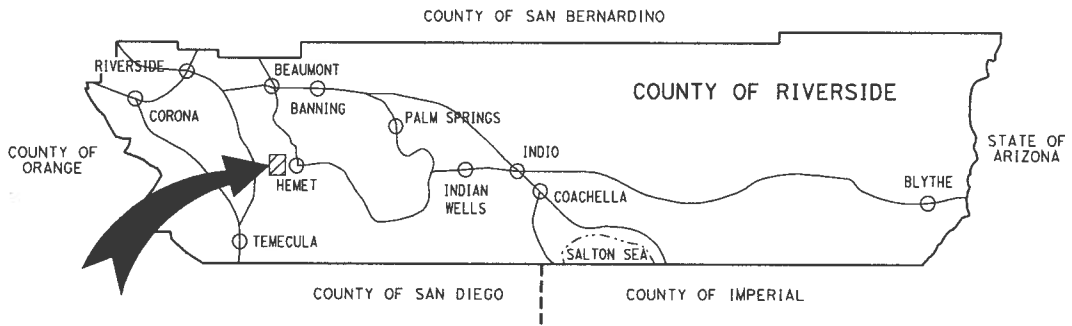

VICINITY MAP

TOWNSHIP 58 RANGE 1W SECTION 10
COUNTY ROAD BOOK PAGE No. 105

COUNTY OF RIVERSIDE
TRANSPORTATION DEPARTMENT

PERRIS COUNTY YARD

RESURFACING

PERRIS

PROJECT No. 15-00008

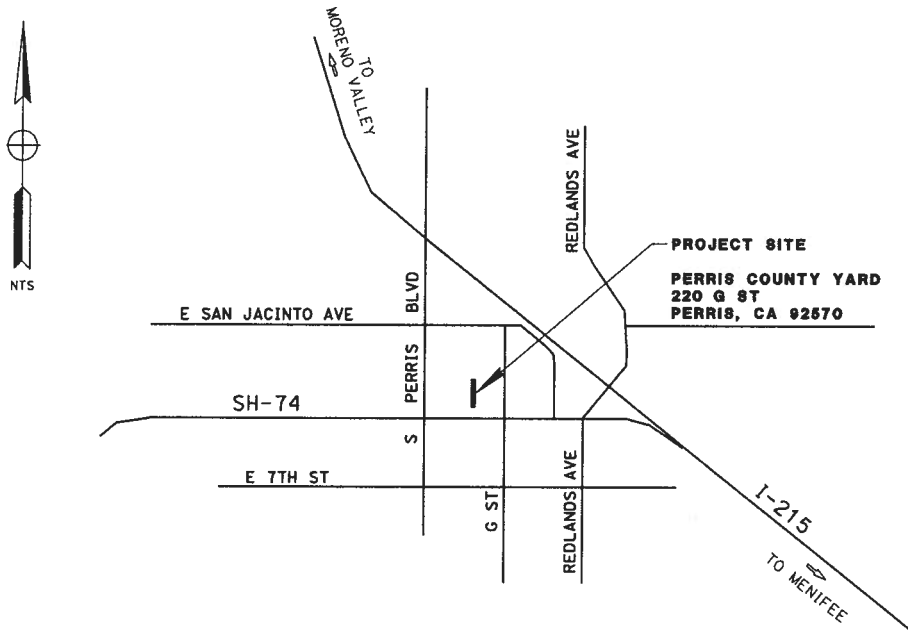
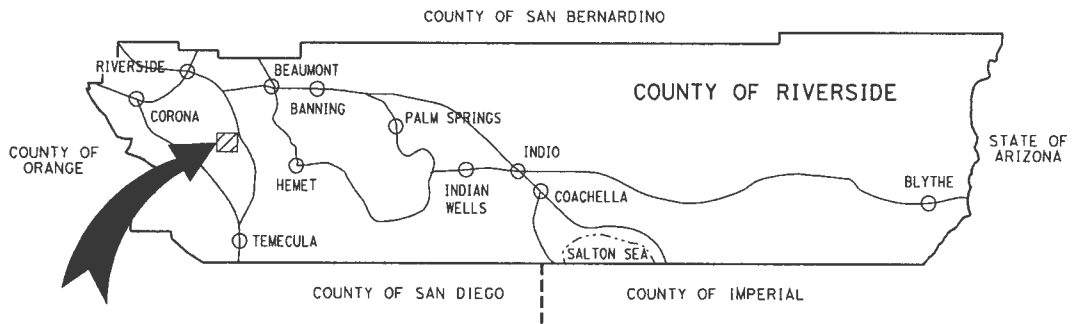

VICINITY MAP

TOWNSHIP 4S RANGE 3W SECTION 32
COUNTY ROAD BOOK PAGE No. 62

**Riverside County Transportation Department
Summary of Bids**

PROJECT:

El Cerrito, Hemet and Perris Maintenance Yards Pavement Resurfacing Projects

Advertised: June 30, 2015 (Agenda Item: 3-63)

Addenda: 1(7/29/2015)

Bids Open: 2 pm Date: Wednesday, August 5, 2015

PROJECT No. 15-00008

	Company Name	Base Bid Subtotal	Alternate Bid Schedule 1 Subtotal	Alternate Bid Schedule 2 Subtotal	Total
	COUNTY'S ESTIMATE	319,200.00	65,870.00	37,190.00	\$422,260.00
1	All American Asphalt	274,204.00	56,572.00	30,380.00	\$361,156.00
2	Hardy & Harper, Inc.	330,000.00	58,000.00	32,000.00	\$420,000.00
3	L.C. Paving & Sealing, Inc.	344,141.00	68,036.00	36,295.00	\$448,472.00
4	Medina Construction, Inc.	367,867.00	61,195.90	34,355.30	\$463,418.20
5	Calmex Engineering, Inc.	380,380.23	63,420.06	30,959.15	\$474,759.44
6	Roadway Eng & Contracting, Inc.	459,480.00	105,950.00	56,970.00	\$622,400.00
7	Jacobson Eng Construction, Inc.	408,494.31	79,263.03	45,530.58	Non Responsive Bid
	Average Bid Prices	\$359,345.37	\$68,862.33	\$36,826.58	\$465,034.27

**Riverside County Transportation Department
Summary of Bids**

**PROJECT: El Cerrito, Hemet and Perris Maintenance Yards
Pavement Resurfacing Projects**

**Advertised: June 30, 2015 (Agenda Item: 3-63)
Addenda: 1/7/29/2015
Bids Open: 2 pm Date: Wednesday, August 5, 2015**

PROJECT No. 15-00008

Base Bid		COUNTY'S ESTIMATE			All American Asphalt Corona, CA 92878			
ITEM NO.	ITEM CODE	CONTRACT ITEM	UNITS	QUANTITY	UNIT PRICE	ENG ESTIMATE	BID UNIT PRICE	BID ESTIMATE
1	066102	DUST ABATEMENT	LS	1	4,500.00	4,500.00	1,600.00	1,600.00
2	074020	WATER POLLUTION CONTROL	LS	1	4,500.00	4,500.00	5,000.00	5,000.00
3	150857	REMOVE ASPHALT CONCRETE SURFACING	LS	1	60,000.00	60,000.00	71,000.00	71,000.00
4	390130	HOT MIX ASPHALT	TON	2,800	85.00	238,000.00	66.00	184,800.00
5	010602	MISCELLANEOUS WORK (AS DIRECTED)	FA	1	10,000.00	10,000.00	10,000.00	10,000.00
5A	013903	PLACE ASPHALT CONCRETE DIKE (CRS 212) (6")	LF	220	10.00	2,200.00	8.20	1,804.00
Base Bid Sub-Total						319,200.00		274,204.00
Items 1-5A								
Alternate Bid Schedule 1 (El Cerrito Maintenance Yard)		COUNTY'S ESTIMATE			All American Asphalt Corona, CA 92878			
ITEM NO.	ITEM CODE	CONTRACT ITEM	UNITS	QUANTITY	UNIT PRICE	ENG ESTIMATE	BID UNIT PRICE	BID ESTIMATE
6	074020	WATER POLLUTION CONTROL	LS	1	500.00	500.00	1,600.00	1,600.00
7	150857	REMOVE ASPHALT CONCRETE SURFACING	LS	1	15,000.00	15,000.00	13,500.00	13,500.00
8	390130	HOT MIX ASPHALT	TON	562	85.00	47,770.00	70.00	39,340.00
8A	013903	PLACE ASPHALT CONCRETE DIKE (CRS 212) (6")	LF	260	10.00	2,600.00	8.20	2,132.00
Alt. Bid Sch. 1 Sub-Total						65,870.00		56,572.00
Items 6-8A								
Alternate Bid Schedule 2 (Perris Maintenance Yard)		COUNTY'S ESTIMATE			All American Asphalt Corona, CA 92878			
ITEM NO.	ITEM CODE	CONTRACT ITEM	UNITS	QUANTITY	UNIT PRICE	ENG ESTIMATE	BID UNIT PRICE	BID ESTIMATE
9	074020	WATER POLLUTION CONTROL	LS	1	500.00	500.00	1,600.00	1,600.00
10	150857	REMOVE ASPHALT CONCRETE SURFACING	LS	1	10,000.00	10,000.00	6,800.00	6,800.00
11	390130	HOT MIX ASPHALT	TON	314	85.00	26,690.00	70.00	21,980.00
Alt. Bid Sch. 2 Sub-Total						37,190.00		30,380.00
Items 9-11								
Project Total						422,260.00		361,156.00
Items 1-11								

**Riverside County Transportation Department
Summary of Bids**

**PROJECT: El Cerrito, Hemet and Perris Maintenance Yards
Pavement Resurfacing Projects**

Advertised: June 30, 2015 (Agenda Item: 3-63)

Addenda: 1(7/29/2015)

Bids Open: 2 pm Date: Wednesday, August 5, 2015

PROJECT No. 15-00008

Base Bid		2		3				
ITEM NO.	ITEM CODE	CONTRACT ITEM	UNITS	QUANTITY	BID UNIT PRICE	BID ESTIMATE	BID UNIT PRICE	BID ESTIMATE
1	066102	DUST ABATEMENT	LS	1	21,000.00	21,000.00	9,259.00	9,259.00
2	074020	WATER POLLUTION CONTROL	LS	1	3,100.00	3,100.00	1,050.00	1,050.00
3	150857	REMOVE ASPHALT CONCRETE SURFACING	LS	1	77,000.00	77,000.00	120,374.00	120,374.00
4	390130	HOT MIX ASPHALT	TON	2,800	77.00	215,600.00	71.65	200,620.00
5	010602	MISCELLANEOUS WORK (AS DIRECTED)	FA	1	10,000.00	10,000.00	10,000.00	10,000.00
5A	013903	PLACE ASPHALT CONCRETE DIKE (CRS 212) (6")	LF	220	15.00	3,300.00	12.90	2,838.00
Base Bid Sub-Total						330,000.00		344,141.00
Items 1-5A								
Alternate Bid Schedule 1 (El Cerrito Maintenance Yard)		2		3				
ITEM NO.	ITEM CODE	CONTRACT ITEM	UNITS	QUANTITY	BID UNIT PRICE	BID ESTIMATE	BID UNIT PRICE	BID ESTIMATE
6	074020	WATER POLLUTION CONTROL	LS	1	826.00	826.00	350.00	350.00
7	150857	REMOVE ASPHALT CONCRETE SURFACING	LS	1	10,000.00	10,000.00	24,149.00	24,149.00
8	390130	HOT MIX ASPHALT	TON	562	77.00	43,274.00	71.50	40,183.00
8A	013903	PLACE ASPHALT CONCRETE DIKE (CRS 212) (6")	LF	260	15.00	3,900.00	12.90	3,354.00
Alt. Bid Sch. 1 Sub-Total						58,000.00		68,036.00
Items 6-8A								
Alternate Bid Schedule 2 (Perris Maintenance Yard)		2		3				
ITEM NO.	ITEM CODE	CONTRACT ITEM	UNITS	QUANTITY	BID UNIT PRICE	BID ESTIMATE	BID UNIT PRICE	BID ESTIMATE
9	074020	WATER POLLUTION CONTROL	LS	1	822.00	822.00	350.00	350.00
10	150857	REMOVE ASPHALT CONCRETE SURFACING	LS	1	7,000.00	7,000.00	13,494.00	13,494.00
11	390130	HOT MIX ASPHALT	TON	314	77.00	24,178.00	71.50	22,451.00
Alt. Bid Sch. 2 Sub-Total						32,000.00		36,295.00
Items 9-11								

Project Total						420,000.00		448,472.00
Items 1-11								

**Riverside County Transportation Department
Summary of Bids**

**PROJECT: El Cerrito, Hemet and Perris Maintenance Yards
Pavement Resurfacing Projects**

Advertised: June 30, 2015 (Agenda Item: 3-63)

Addenda: 1(7/29/2015)

Bids Open: 2 pm Date: Wednesday, August 5, 2015

PROJECT No. 15-00008

Base Bid		4			5			
ITEM NO.	ITEM CODE	CONTRACT ITEM	UNITS	QUANTITY	BID UNIT PRICE	BID ESTIMATE	BID UNIT PRICE	BID ESTIMATE
1	066102	DUST ABATEMENT	LS	1	2,500.00	2,500.00	15,342.06	15,342.06
2	074020	WATER POLLUTION CONTROL	LS	1	2,600.00	2,600.00	1,104.78	1,104.78
3	150857	REMOVE ASPHALT CONCRETE SURFACING	LS	1	135,000.00	135,000.00	135,292.19	135,292.19
4	390130	HOT MIX ASPHALT	TON	2,800	76.45	214,060.00	76.95	215,460.00
5	010602	MISCELLANEOUS WORK (AS DIRECTED)	FA	1	10,000.00	10,000.00	10,000.00	10,000.00
5A	013903	PLACE ASPHALT CONCRETE DIKE (CRS 212) (6")	LF	220	16.85	3,707.00	14.46	3,181.20
Base Bid Sub-Total Items 1-5A						367,867.00		380,380.23
Alternate Bid Schedule 1 (El Cerrito Maintenance Yard)		4			5			
ITEM NO.	ITEM CODE	CONTRACT ITEM	UNITS	QUANTITY	BID UNIT PRICE	BID ESTIMATE	BID UNIT PRICE	BID ESTIMATE
6	074020	WATER POLLUTION CONTROL	LS	1	850.00	850.00	1,004.25	1,004.25
7	150857	REMOVE ASPHALT CONCRETE SURFACING	LS	1	13,000.00	13,000.00	19,930.15	19,930.15
8	390130	HOT MIX ASPHALT	TON	562	76.45	42,964.90	69.93	39,300.66
8A	013903	PLACE ASPHALT CONCRETE DIKE (CRS 212) (6")	LF	260	16.85	4,381.00	12.25	3,185.00
Alt. Bid Sch. 1 Sub-Total Items 6-8A						61,195.90		63,420.06
Alternate Bid Schedule 2 (Perris Maintenance Yard)		4			5			
ITEM NO.	ITEM CODE	CONTRACT ITEM	UNITS	QUANTITY	BID UNIT PRICE	BID ESTIMATE	BID UNIT PRICE	BID ESTIMATE
9	074020	WATER POLLUTION CONTROL	LS	1	850.00	850.00	1,027.53	1,027.53
10	150857	REMOVE ASPHALT CONCRETE SURFACING	LS	1	9,500.00	9,500.00	7,282.80	7,282.80
11	390130	HOT MIX ASPHALT	TON	314	76.45	24,005.30	72.13	22,648.82
Alt. Bid Sch. 2 Sub-Total Items 9-11						34,355.30		30,959.15

Project Total Items 1-11						463,418.20		474,759.44
-------------------------------------	--	--	--	--	--	-------------------	--	-------------------

El Cerrito, Hemet, Perris (15-00008): SUMMARY-WEB
Updated: 8/5/2015

**Riverside County Transportation Department
Summary of Bids**

**PROJECT: El Cerrito, Hemet and Perris Maintenance Yards
Pavement Resurfacing Projects**

**Advertised: June 30, 2015 (Agenda Item: 3-63)
Addenda: 1(7/29/2015)
Bids Open: 2 pm Date: Wednesday, August 5, 2015**

PROJECT No. 15-00008

Base Bid		6		7				
ITEM NO.	ITEM CODE	CONTRACT ITEM	UNITS	QUANTITY	BID UNIT PRICE	BID ESTIMATE	BID UNIT PRICE	BID ESTIMATE
1	066102	DUST ABATEMENT	LS	1	1,000.00	1,000.00	16,542.88	16,542.88
2	074020	WATER POLLUTION CONTROL	LS	1	8,300.00	8,300.00	7,604.70	7,604.70
3	150857	REMOVE ASPHALT CONCRETE SURFACING	LS	1	142,000.00	142,000.00	106,944.53	106,944.53
4	390130	HOT MIX ASPHALT	TON	2,800	105.00	294,000.00	92.31	258,468.00
5	010602	MISCELLANEOUS WORK (AS DIRECTED)	FA	1	10,000.00	10,000.00	10,000.00	10,000.00
5A	013903	PLACE ASPHALT CONCRETE DIKE (CRS 212) (6")	LF	220	19.00	4,180.00	40.61	8,934.20
Base Bid Sub-Total						459,480.00		408,494.31
Items 1-5A								
Alternate Bid Schedule 1 (El Cerrito Maintenance Yard)		6		7				
ITEM NO.	ITEM CODE	CONTRACT ITEM	UNITS	QUANTITY	BID UNIT PRICE	BID ESTIMATE	BID UNIT PRICE	BID ESTIMATE
6	074020	WATER POLLUTION CONTROL	LS	1	2,000.00	2,000.00	1,000.00	1,000.00
7	150857	REMOVE ASPHALT CONCRETE SURFACING	LS	1	40,000.00	40,000.00	14,915.77	14,915.77
8	390130	HOT MIX ASPHALT	TON	562	105.00	59,010.00	93.93	52,788.66
8A	013903	PLACE ASPHALT CONCRETE DIKE (CRS 212) (6")	LF	260	19.00	4,940.00	40.61	10,558.60
Alt. Bid Sch. 1 Sub-Total						105,950.00		79,263.03
Items 6-8A								
Alternate Bid Schedule 2 (Perris Maintenance Yard)		6		7				
ITEM NO.	ITEM CODE	CONTRACT ITEM	UNITS	QUANTITY	BID UNIT PRICE	BID ESTIMATE	BID UNIT PRICE	BID ESTIMATE
9	074020	WATER POLLUTION CONTROL	LS	1	2,000.00	2,000.00	Missing unit cost	Missing item total
10	150857	REMOVE ASPHALT CONCRETE SURFACING	LS	1	22,000.00	22,000.00	Missing unit cost	Missing item total
11	390130	HOT MIX ASPHALT	TON	314	105.00	32,970.00	Missing unit cost	Missing item total
Alt. Bid Sch. 2 Sub-Total						56,970.00		45,530.58
Items 9-11								
Project Total						622,400.00	Non Responsive	
Items 1-11								



Juan C. Perez, P.E., T.E.
Director of Transportation and Land
Management

COUNTY OF RIVERSIDE TRANSPORTATION AND LAND MANAGEMENT AGENCY

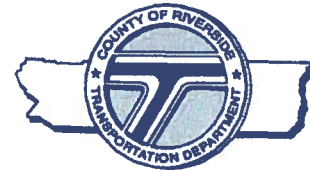

Patricia Romo, P.E.
Assistant Director of Transportation

Transportation Department

ADDENDUM NUMBER 1

Dated July 29, 2015

to the
Specifications and Contract Documents
for the construction of

El Cerrito, Hemet and Perris
Maintenance Yards Pavement Resurfacing Project

Project No. 15-00008

Bids Due: **Wednesday, August 5, 2015; 2:00 p.m.**
14th Street Transportation Annex
3525 14th Street; Riverside, CA 92501
(951) 955-6780

This Addendum is issued pursuant to Section 8 of Instructions to Bidders of the Contract Documents for the reference project. This Addendum is issued as a supplement to the specification and special provisions for the referenced project. The revisions to the plans and specifications shall become a part of the Contract Documents, and each bidder shall acknowledge receipt thereof on the Contractor's Bid. Bidders are directed to sign this addendum as acknowledged, and attach the signed addendum to the contractor's submitted Bid.

Note: During the advertisement period of this project, this document and attachments (if any) are available upon request at the office of the Transportation Department, and are available as a free download at the Transportation Department's website:

<http://rctlma.org/trans/Contractors-Corner/Notices-Inviting-Bids>

MODIFICATIONS / CLARIFICATIONS TO SPECIAL PROVISIONS:

- Item 1: Public Works Contractor Registration Program**
All bidding **contractors and subcontractors** are being advised that no contractor or subcontractor may be awarded a contract for public works on a public works project (awarded on or after April 1, 2015) unless registered with the Department of Industrial Relations pursuant to labor Code section 1725.5.
- Item 2: Revised Proposal**
Refer to "Proposal" [page B2](#) of the Special Provisions. Delete and replace "PROPOSAL" (page B2) with revised "Proposal" attached herewith as **Attachment "A"**. The following revisions have been made to the bid Proposal:

Item 5: Clearing and Grubbing

Refer to section "Clearing and Grubbing" on page 11 of Special Provisions. Following additional requirement included and made part thereof.

Clearing and Grubbing work shall include the removal and disposal of existing gravels/crushed rocks near northerly yard boundary west of existing building at Perris maintenance yard. Contractor shall keep 5' wide setback from the fence for removal of gravels/crushed rocks. The approximate area of removal is 435 Square Feet.

Note: County Forces will clear the sites of all three maintenance yards to keep County owned construction materials and equipment out of the way of contractor.

Item 6: Hot Mix Asphalt

Refer to section "Hot Mix Asphalt" and fifth paragraph under subsection entitled "Applying Asphalt" on page 14 of Special Provisions. Delete the fifth paragraph entirely from Liquid Asphalt...through...specified in the Special Provisions.

Following provisions added and made part thereof:

Perris Maintenance Yard:

Contract shall protect existing concrete pad around the building and new pavement shall be joined 0.1' below the concrete pad surface.

Alternate Bid Schedule 2

If alternate bid schedule 2 was selected for award, contractor's attention is directed to the stockpile that exists in the "Area 2" delineated on Exhibit for Perris yard. County forces will remove the stockpile prior to contractor's operation. Removal of AC berm around the stockpile area and pavement under the stockpile shall be considered as included in the pavement removal work for Alternate Bid Schedule 2 and no additional compensation will be allowed therefor.

Hemet maintenance yard:

Contractor shall remove existing ribbon gutter where marked on the existing pavement prior to resurfacing. The existing ribbon gutter is approximately 60 feet in length and 8 feet in width buried under the AC surface. Ribbon gutter removal area shall be backfilled and compacted prior to resurfacing.

Contractor shall pave flush to the building pad as it currently exists and as close as possible to existing fence.

Note: the unidentified utility line seen at the Hemet Yard was not active, and has been removed by County forces. No trenching to remove or relocate this line is required. Contractor is to assume electrical lines not seen are shallow.

Protect Existing Facilities:

Contractor must protect existing utilities, irrigation lines, fence/gate, and all other structures those needed to be protected from being damaged by construction activities. In the event any facility got damaged due to construction operation, contractor will be solely responsible to repair in kind or better without any compensation from the County.

Ib = California statewide crude oil price index for the month in which the bid opening for the project occurred

T = Sales and use tax rate expressed as a percent currently in effect in the tax jurisdiction where the material is placed. If the tax rate information is not submitted timely, the statewide sales and use tax rate is used in the payment adjustment calculations until the tax rate information is submitted.

Item 8: Place Asphalt Concrete Dike

Following Special Provisions added and made part hereof:

PLACE ASPHALT CONCRETE DIKE:

Asphalt concrete dikes shall conform to the County Road Improvement Standards and Specifications, and as directed by the Engineer.

Contractor shall remove and dispose of existing AC Berm.

The pay quantity for placing of asphalt concrete dikes shall also include the quantity of Hot Mix Asphalt material. HMAC Material needed for AC Dike **will not** be paid separately.

Location of asphalt concrete dike will be for the El Cerrito Maintenance Yard. Quantities for this site are separated between the Base Bid schedule and Alternate Bid Schedule 1.

Asphalt binder to be mixed with the aggregate shall be PG 70-10 in accordance with the Special Provision for Asphalt, or as directed by the Engineer.

County's AC Dike Standard is attached as an **Attachment B**.

Payment

The contract unit prices paid per linear foot for Place Asphalt Concrete Dike, and shall include full compensation for furnishing all labor, materials (including HMAC), removal of existing AC Berm, , tools, and equipment and for doing all work involved in placing and compacting the dikes, construction of transition AC Berm and no additional compensation will be allowed therefor.

ATTACHMENTS

A – Revised Proposal

B – County Standard for AC Dike (CRS 212) (6")

**El Cerrito, Hemet and Perris
Maintenance Yards Pavement Resurfacing Projects**

Project No. 15-00008

Attachment A
Issued By: Addendum 1

PROPOSAL(REVISED)

ITEM No.	ITEM CODE	ITEM	UNIT	ESTIMATED QUANTITY	ITEM PRICE (IN FIGURES)	TOTAL (IN FIGURES)
BASE BID						
1	066102	DUST ABATEMENT	LS	1		
2	074020	WATER POLLUTION CONTROL	LS	1		
3	150857	REMOVE ASPHALT CONCRETE SURFACING	LS	1		
4	390130	HOT MIX ASPHALT	TON	2,800		
5	010602	MISCELLANEOUS WORK (AS DIRECTED)	FA	1	10,000.00	10,000.00
5A	013903	PLACE ASPHALT CONCRETE DIKE (CRS 212) (6")	LF	220		

BASE BID _____ \$ _____
ITEMS 1-5A _____ "WORDS"

ALTERNATE BID SCHEDULE 1 (EL CERRITO MAINTENANCE YARD)

6	074020	WATER POLLUTION CONTROL	LS	1		
7	150857	REMOVE ASPHALT CONCRETE SURFACING	LS	1		
8	390130	HOT MIX ASPHALT	TON	562		
8A	013903	PLACE ASPHALT CONCRETE DIKE (CRS 212) (6")	LF	260		

ALT. BID SCH. 1 _____ \$ _____
ITEMS 6-8A _____ "WORDS"

ALTERNATE BID SCHEDULE 2 (PERRIS MAINTENANCE YARD)

9	074020	WATER POLLUTION CONTROL	LS	1		
10	150857	REMOVE ASPHALT CONCRETE SURFACING	LS	1		
11	390130	HOT MIX ASPHALT	TON	314		

ALT. BID SCH.2 _____ \$ _____
ITEMS 9-11 _____ "WORDS"

PROJECT TOTAL: _____ \$ _____
ITEMS 1-11 _____ "WORDS"

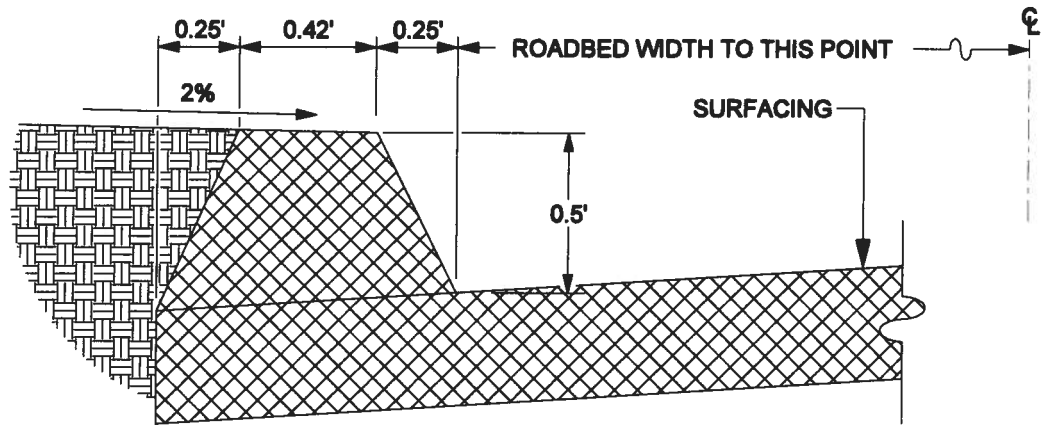

6" A.C. DIKE

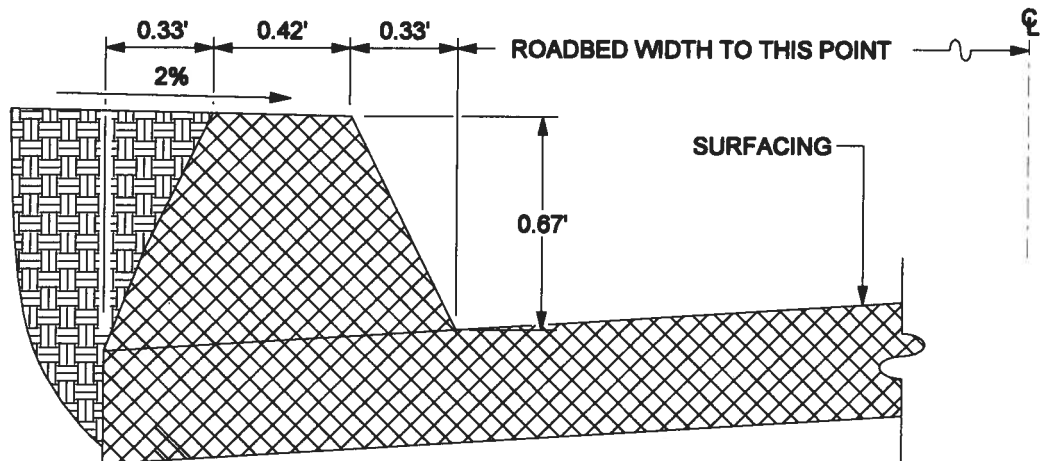

8" A.C. DIKE

NOT TO SCALE

NOTE: A.C. DIKE REQUIRED WHERE FILL SLOPES ARE STEEPER THAN 4:1, MATERIAL IS SUSCEPTIBLE TO EROSION, OR WHERE ROADWAY GRADIENT EXCEEDS 3%.

APPROVED BY:

George A. Johnson
 DIRECTOR OF TRANSPORTATION
 GEORGE A. JOHNSON, RCE 42328

DATE: 05/01/07

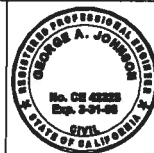

COUNTY OF RIVERSIDE

**ASPHALT CONCRETE
 DIKES**

REVISIONS	REV.	BY:	APR'D	DATE	REV.	BY:	APR'D	DATE
	1				4			
	2				5			
	3				6			

STANDARD NO. 212



COUNTY OF RIVERSIDE
TRANSPORTATION AND
LAND MANAGEMENT AGENCY



Juan C. Perez, P.E., T.E.
Director of Transportation and
Land Management

Transportation Department

Patricia Romo, P.E.
Assistant Director of Transportation

August 7, 2015

ECOPIY

Dan Jacobsson, President
Jacobsson Engineering Construction, Inc.
79-301 Country Club Dr. #103
Bermuda Dunes, CA 92203

Re: Return of Non-Responsive Bid
El Cerrito, Hemet and Perris
Maintenance Yards Pavement Resurfacing Project
Project No. 15-00008

Dear Mr. Jacobsson:

This letter is to inform you that the Bid that your firm has submitted for the referenced project was not complete and has been found not to be responsive to the bidding requirements set forth for that project.

In accordance with section 15 "Bids" starting on page A7 of the contract document the County of Riverside is rejecting your bid, received August 5, 2015, as being non-responsive due to the following irregularity:

- Bid items 9, 10, and 11 unit prices and subtotal prices were omitted in the bid.

We are therefore sending you the original submitted Bid Bond and a copy of your submitted Bid. If you have any questions or need additional information, please contact me at your convenience at (951) 955-1537 or Saleem Baig at (951) 955-1682.

Sincerely,

Joel Jimenez, P.E.
Senior Civil Engineer
Contracts/ Bidding Unit

JRJ:jj:sb

Attachments: Copy of Bid package, Original Bid Bond
Summary of Bids

cc: Khalid Nasim / Kelley Donovan, Transportation Department
Marsha Victor, Office of County Counsel
Chronological File, Project File with copy of Attachments

Bid

Date: August 4, 2015

To: County of Riverside, hereafter called "County";

Bidder: Jacobsson Engineering Construction, Inc.
(hereafter called "Contractor")

The undersigned, Contractor, having carefully examined the site and the Contract Documents for the construction of El Cerrito, Hemet and Perris Maintenance Yards Pavement Resurfacing Projects, Project No. 15-00008 hereby proposes to construct the work in accordance with the Contract Documents, including Addenda Number(s) 1 (Fill in addenda numbers if addenda have been issued.) for the amount stated in this Bid.

By submitting this Bid, Contractor agrees with County:

1. That unless withdrawn in person by Contractor or some person authorized in writing by Contractor (not by telephone or facsimile) before the time specified in the Notice Inviting Bids for the public opening of bids, this Bid constitutes an irrevocable offer for 90 calendar days after that date.
2. County has the right to reject any or all Bids and to waive any irregularities or informalities contained in a Bid.
3. To execute the Contract and deliver the Performance Bond, Payment Bond and Insurance Certificate with endorsements, that comply with the requirements set forth in the Instruction to Bidders and General Conditions within ten (10) business days of the date of the Notice of Acceptance of Bid and Intent to Award as issued by the County.
4. That the contract shall be awarded upon a resolution or minute order to that effect duly adopted by the governing body of County; and that execution of the Contract shall constitute a written memorial thereof.
5. To submit to the County such information as County may require determining whether a particular Bid is the lowest responsible bid submitted.
6. That the accompanying Bid Bond, certified check or cashier's check is in an amount not less than 10% of the total bid submitted and constitutes a guarantee that if awarded the contract, Contractor will execute the Contract and deliver the required bonds within ten (10) business days after notice of award. If Contractor fails to execute and deliver said documents, the bond or check is to be charged with the costs of the resultant damages to the County, including but not limited to: publication costs, the difference in money between the amount bid and the amount in excess of the bid which it costs County to do or cause to be done for the work involved, lease and rental costs, additional salaries and overhead, increased interest and costs of funding the project, attorney expense, additional engineering and architectural expense and cost of maintaining or constructing alternate facilities occasioned by the failure to execute and deliver said documents.
7. By signing this Bid the Contractor certifies that the representations made therein are made under penalty of perjury.

**El Cerrito, Hemet and Perris
Maintenance Yards Pavement Resurfacing Projects**

Project No. 15-00008

Attachment A
Issued By: Addendum 1

PROPOSAL(REVISED)

ITEM No.	ITEM CODE	ITEM	UNIT	ESTIMATED QUANTITY	ITEM PRICE (IN FIGURES)	TOTAL (IN FIGURES)
BASE BID						
1	066102	DUST ABATEMENT	LS	1	16,542.88	16,542.88
2	074020	WATER POLLUTION CONTROL	LS	1	7,604.70	7,604.70
3	150857	REMOVE ASPHALT CONCRETE SURFACING	LS	1	106,944.53	106,944.53
4	390130	HOT MIX ASPHALT	TON	2,800	92.31	258,468.28
5	010602	MISCELLANEOUS WORK (AS DIRECTED)	FA	1	10,000.00	10,000.00
5A	013903	PLACE ASPHALT CONCRETE DIKE (CRS 212) (6")	LF	220	40.61	8,934.20

BASE BID ITEMS 1-5A Four hundred eight thousand four hundred ninety four ³/₁₀₀ \$408,494.31
"WORDS"

ALTERNATE BID SCHEDULE 1 (EL CERRITO MAINTENANCE YARD)

6	074020	WATER POLLUTION CONTROL	LS	1	1,000	1,000
7	150857	REMOVE ASPHALT CONCRETE SURFACING	LS	1	14,915.77	14,915.77
8	390130	HOT MIX ASPHALT	TON	562	93.93	52,788.66
8A	013903	PLACE ASPHALT CONCRETE DIKE (CRS 212) (6")	LF	260	40.61	10,558.60

ALT. BID SCH. 1 ITEMS 6-8A Seventy nine thousand two hundred sixty three ⁰³/₁₀₀ \$79,263.03
"WORDS"

ALTERNATE BID SCHEDULE 2 (PERRIS MAINTENANCE YARD)

9	074020	WATER POLLUTION CONTROL	LS	1		
10	150857	REMOVE ASPHALT CONCRETE SURFACING	LS	1		
11	390130	HOT MIX ASPHALT	TON	314		

Missing unit and total prices

ALT. BID SCH. 2 ITEMS 9-11 Forty five thousand five hundred thirty ⁵⁸/₁₀₀ \$45,530.58
"WORDS"

PROJECT TOTAL: Five hundred thirty three thousand two hundred eighty seven ⁹¹/₁₀₀ \$533,287.91
"WORDS"

Bidder Data and Signature

Name of Bidder: Jacobsson Engineering Construction, Inc.

Type of organization: Corporation

Person(s) authorized to sign for Bidder: Dan Jacobsson

Dsn Jacobsson, President

Natalie Jacobsson, Secretary

Note:

If Bidder is a **Corporation**, state legal name of Corporation and also names of the president, vice-president, secretary, treasurer and manager thereof.

If Bidder is a **Co-Partnership**, state true name of firm and also names of all individual co-partners composing firm.

If Bidder is a sole proprietorship or an **Individual**, state first and last name(s) in full.

If Bid is signed by an agent other than an owner, partner or corporate officer, Bid shall be accompanied by a power-of-attorney.

Business Street Address: 79-301 Country Club Dr. #103
(Please include business address even if P.O. Box is used.)

Business City, State, Zip Code: Bermuda Dunes, CA 92203

P.O. Box- Number: PO Box 14430

P.O. Box- City, State, Zip Code: Palm Desert, CA 92255

Phone: (760) 345-8700

Facsimile: (760) 345-8799

E-mail: info@jacobssoninc.com

Contractor's license number: 650389 A & B

License Classification(s): A & B

Expiration date: 07-31-16

Department of Industrial Relations Registration Number: 1000008233

Bidder Data and Signature (continued)

Accompanying this Bid is a certified check, cashier check or bid bond in an amount equal to at least ten (10) percent of the total bid for:

**El Cerrito, Hemet and Perris
Maintenance Yards Pavement Resurfacing Project
Project No. 15-00008**

By my signature on this Bid, I certify, under penalty of perjury under the laws of the State of California, that all the information on this form is true and correct.

IN WITNESS WHERE OF Bidder/Contractor executed this Bid as of the date set forth on page B1 of this Bid.

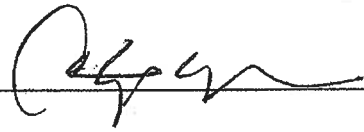
Signature:  _____

Name (printed): Dan Jacobsson _____

Title: President _____
"Contractor"

Contract

THIS CONTRACT is entered into at Riverside, California as of the date set forth below is between County of Riverside hereafter called "County" and **All American Asphalt**, hereafter called "Contractor".

WITNESSETH

Recitals:

1. Contractor has submitted to County his Contractor's Proposal for the construction of County Project, **El Cerrito, Hemet and Perris Maintenance Yards Pavement Resurfacing Project, Project No. 15-00008**, in strict accordance with the Contract Documents identified below and County has accepted said Proposal.
2. Contractor states that he has reexamined his Contractor's Proposal and found it to be correct, has ascertained that his subcontractors are properly licensed and possess the requisite skill and forces, has reexamined the site and Contract Documents and is of the opinion that he can presently do the work in accordance with the Contract Documents for the money set forth in his Proposal to be paid as provided in the Contract Documents.

Agreement:

It is agreed by the parties as follows:

1. Contract Documents

The entire Contract consists of the following: (a) The Construction Contract, (b) The Notice Inviting Bids, (c) The Instruction to Bidders, (d) The Bid, (e) The Bid Bond, (f) The Payment Bond, (g) The Performance Bond, (h) The General Conditions, (i) The Special Provisions, (j) The Standard Specifications of the State of California Department of Transportation edition of **May 2006** as modified in other portions of the Contract Documents and as amended by the State of California Department of Transportation, (k) The Standard Plans of the Department of Transportation identified on the plans or in the Special Provisions, (l) The Plans, (m) Addenda **one**, (n) The Determination of Prevailing Wage Rates for Public Work, (o) Any Change Orders issued, (p) Any additional or supplemental specifications, notice, instructions and drawings issued in accordance with the provisions of the Contract Documents. All of said Documents presently in existence are by this reference incorporated herein with like effect as if here set forth in full and upon the proper issuance of other documents they shall likewise be deemed incorporated. The Bid Bond is exonerated upon execution of this Contract and the Payment Bond and Performance Bond.

2. The Work

Contractor shall do all tasks necessary to construct the work generally described in Recital No. 1 in accordance with the Contract Documents.

3. Liquidated Damages and Time of Completion

Attention is directed to the provisions in Section 8-1.06, "Time of Completion", and in Section 8-1.07 "Liquidated Damages", of the Standard Specifications and these Special Provisions.

Standard Specification Section 8-1.03, "Beginning of Work" is modified to read as follows:

The Contractor shall begin work within fifteen (15) calendar days, or as revised in the Special Provisions, of the date stated within the written "Notice to Proceed".

The Contractor shall notify the Engineer, in writing, of the Contractor's intent to begin work at least 72 hours before work is begun. If the project has more than one (1) location of work, Contractor shall submit a separate notice for each location. The notice shall be delivered to the Transportation Department's Construction Engineer and shall specify the date the Contractor intends to start at said location.

Should the Contractor begin work in advance of receiving a written "Notice to Proceed", any work performed by the Contractor in advance of the date stated in the "Notice to Proceed" shall be considered as having been done by the Contractor at his own risk and as a volunteer and subject to the following:

- A. The Contractor shall, on commencing operations, take all precautions required for public safety and shall observe all the provisions in the Specifications and the Special Provisions.
- B. All work done according to the Contract, prior to the issuance of the "Notice to Proceed", will be considered authorized work and will be paid for as provided in the contract.
- C. The Contractor shall not be entitled to any additional compensation or an extension of time for any delay, hindrance or interference caused by or attributable to commencement of work prior to the issuance of the "Notice to Proceed".

4. Compensation

Contractor shall be paid in the manner set forth in the Contract Documents the amount of his Proposal as accepted by County, the above rates, subject to additions and deductions as provided in the Contract Documents. Said Proposal is on file in the Office of the Clerk of the Board of Supervisors of County.

**El Cerrito, Hemet and Perris
Maintenance Yards Pavement Resurfacing Project
Project No. 15-00008**

Contract

Base Bid

ITEM No.	ITEM CODE	ITEM	UNIT	ESTIMATED QUANTITY	ITEM PRICE (IN FIGURES)	TOTAL (IN FIGURES)
1	066102	DUST ABATEMENT	LS	1	1,600.00	1,600.00
2	074020	WATER POLLUTION CONTROL	LS	1	5,000.00	5,000.00
3	150857	REMOVE ASPHALT CONCRETE SURFACING	LS	1	71,000.00	71,000.00
4	390130	HOT MIX ASPHALT	TON	2,800	66.00	184,800.00
5	010602	MISCELLANEOUS WORK (AS DIRECTED)	FA	1	10,000.00	10,000.00
5A	013903	PLACE ASPHALT CONCRETE DIKE (CRS 212) (6")	LF	220	8.20	1,804.00

BASE BID

SUB TOTAL Two hundred seventy four thousand, two hundred four dollars and zero cents **\$ 274,204.00**

ITEMS 1-5A "WORDS"

Alternate Bid Schedule 1 (El Cerrito Maintenance Yard)

ITEM No.	ITEM CODE	ITEM	UNIT	ESTIMATED QUANTITY	ITEM PRICE (IN FIGURES)	TOTAL (IN FIGURES)
6	074020	WATER POLLUTION CONTROL	LS	1	1,600.00	1,600.00
7	150857	REMOVE ASPHALT CONCRETE SURFACING	LS	1	13,500.00	13,500.00
8	390130	HOT MIX ASPHALT	TON	562	70.00	39,340.00
8A	013903	PLACE ASPHALT CONCRETE DIKE (CRS 212) (6")	LF	260	8.20	2,132.00

ALT BID SCH. 1

SUB TOTAL Fifty six thousand, five hundred seventy two dollars and zero cents **\$56,572.00**

ITEMS 6-8A "WORDS"

Alternate Bid Schedule 2 (Perris Maintenance Yard)

ITEM No.	ITEM CODE	ITEM	UNIT	ESTIMATED QUANTITY	ITEM PRICE (IN FIGURES)	TOTAL (IN FIGURES)
9	074020	WATER POLLUTION CONTROL	LS	1	1,600.00	1,600.00
10	150857	REMOVE ASPHALT CONCRETE SURFACING	LS	1	6,800.00	6,800.00
11	390130	HOT MIX ASPHALT	TON	314	70.00	21,980.00

ALT BID SCH. 2

SUB TOTAL Thirty thousand, three hundred eighty dollars and zero cents **\$30,380.00**

ITEMS 9-11 "WORDS"

PROJECT

TOTAL Three hundred sixty one thousand, one hundred fifty six dollars and zero cents **\$361,156.00**

ITEMS 1-11 "WORDS"

**El Cerrito, Hemet and Perris
Maintenance Yards Pavement Resurfacing Project
Project No. 15-00008**

IN WITNESS WHEREOF the parties hereto have executed this Contract as of the date set forth below.

COUNTY OF RIVERSIDE

ALL AMERICAN ASPHALT

BY: _____

Chairman, Board of Supervisors

DATED: _____

ATTEST:

Kecia Harper-Ihem, Clerk of the Board

BY: _____

Deputy

BY:  _____

TITLE: Edward J. Carlson, Vice President
(If Corporation, affix Seal)

ATTEST:

 _____

TITLE: Michael Farkas, Secretary

Licensed in accordance with an act providing
for the registration of Contractors,

License No.: **267073**

Department of Industrial Relations No.:
1000001051

Federal Employer Identification Number:

95-2595043

BY _____

"County"

All American Asphalt
"Corporation"
(Seal)



ALL AMERICAN ASPHALT
ALL AMERICAN AGGREGATES

T 951-736-7600 F 951-739-4671
P.O. BOX 2229, CORONA, CA 92878-2229
CONTRACTORS LICENSE #267073 AC12
DIR #1000001051

CORPORATE RESOLUTION

Resolved, that this Corporation, All American Asphalt, on May 4, 2015 authorizes Edward J. Carlson to execute contracts and agreements on behalf of the Company in the capacity of Vice President.



Michael Farkas
Secretary

Performance Bond

Bond No. 7646003
Premium: \$1,427.00
Premium is for contract term and is subject
To adjustment based on final contract price.
Executed in: 2 Counterparts

Recitals:

1. All American Asphalt, (Contractor) has entered into an Agreement with COUNTY OF RIVERSIDE (County) for construction of public work known as El Cerrito, Hemet and Perris Maintenance Yards Pavement Resurfacing Project, Project No. 15-00008.
2. Fidelity and Deposit Company of Maryland, a Maryland corporation (Surety), is the Surety under this Bond.

Agreement:

We, Contractor as Principal and Surety as Surety, jointly and severally agree, state, and are bound unto County, as obligee, as follows:

1. The amount of the obligation of this Bond is 100% of the estimated contract price for the Project of \$361,156.00 (Three hundred sixty one thousand, one hundred fifty six dollars and zero cents) and inures to the benefit of County.
2. This Bond is exonerated by Contractor doing all things to be kept and performed by it in strict conformance with the Contract Documents for this project, otherwise it remains in full force and effect for the recovery of loss, damage and expense of County resulting from failure of Contractor to so act. All of said Contract Documents are incorporated herein.
3. This obligation is binding on our successors and assigns.
4. For value received, Surety stipulates and agrees that no change, time extension, prepayment to Contractor, alteration or addition to the terms and requirements of the Contract Documents or the work to be performed thereunder shall affect its obligations hereunder and waives notice as to such matters, except the total contract price cannot be increased by more than 10% without approval of Surety.

THIS BOND is executed as of August 11, 2015

All American Asphalt
By [Signature]

Fidelity and Deposit Company of Maryland
By Rebecca Haas-Bates

By Edward J. Carlson

Type Name Rebecca Haas-Bates

Its Attorney in Fact
"Surety"

Title Vice President

"Contractor"

(Corporate Seal)

(Corporate Seal)

NOTE: This Bond must be executed by both parties with corporate seal affixed. All signatures must be acknowledged. (Attach acknowledgements).

CALIFORNIA ALL-PURPOSE ACKNOWLEDGEMENT

CIVIL CODE § 1189

A notary public or other officer completing this certificate verifies only the identity of the individual who signed the document to which this certificate is attached, and not the truthfulness, accuracy, or validity of that document.

State of California

County of Riverside

On 8/13/2015 before me, Rebecca Angela Parra, Notary Public,
Date Here Insert name and Title of the Officer

personally appeared Edward J. Carlson
Name(s) of Signer(s)

who proved to me on the basis of satisfactory evidence to be the person(s) whose name(s) is/are subscribed to the within instrument and acknowledged to me that he/~~she~~/they executed the same in his/~~her~~/their authorized capacity(ies), and that by his/~~her~~/their signature(s) on the instrument the person(s), or the entity upon behalf of which the person(s) acted, executed the instrument.

I certify under PENALTY OF PERJURY under the laws of the State of California that the forgoing paragraph is true and correct.

WITNESS my hand and official seal.

Signature *Rebecca Angela Parra*
Signature of Notary Public



Place Notary Seal Above

OPTIONAL

Though the information below is not required by law, it may prove valuable to person relying on the document and could prevent fraudulent removal and reattachment of this form to another document.

Description of Attached Document

Title or Type of Document Performance Bond No. 7646003

Document Date: 8/11/2015 Number of Pages: One (1)

Signer(s) Other Than Named Above: Fidelity and Deposit Company of Maryland

Capacity(ies) Claimed by Signer(s)

Signer's Name: Edward J. Carlson

- Individual
- Corporate Officer — Title(s): Vice President
- Partner Limited General
- Attorney in Fact
- Trustee
- Other: _____

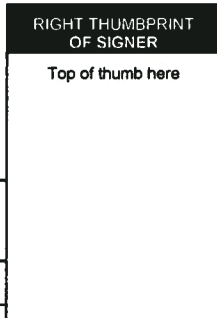

Signer is Representing:
All American Asphalt

Signer's Name: _____

- Individual
- Corporate Officer — Title(s): _____
- Partner Limited General
- Attorney in Fact
- Trustee
- Other: _____

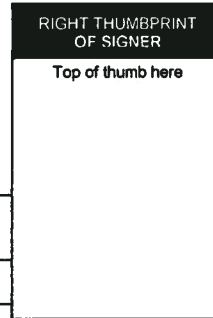

Signer is Representing:

CALIFORNIA ALL-PURPOSE ACKNOWLEDGMENT

CIVIL CODE § 1189

A notary public or other officer completing this certificate verifies only the identity of the individual who signed the document to which this certificate is attached, and not the truthfulness, accuracy, or validity of that document.

State of California)
County of Orange)

On 08/11/2015 before me, R. Paramo, Notary Public
Date Here Insert Name and Title of the Officer

personally appeared Rebecca Haas-Bates
Name(s) of Signer(s)

who proved to me on the basis of satisfactory evidence to be the person(s) whose name(s) is/are subscribed to the within instrument and acknowledged to me that he/she/they executed the same in his/her/their authorized capacity(ies), and that by his/her/their signature(s) on the instrument the person(s), or the entity upon behalf of which the person(s) acted, executed the instrument.

I certify under PENALTY OF PERJURY under the laws of the State of California that the foregoing paragraph is true and correct.

WITNESS my hand and official seal.

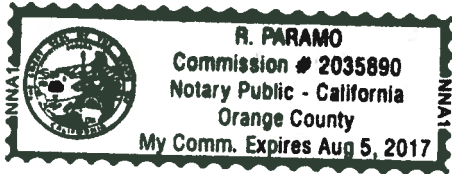

Signature [Handwritten Signature]
Signature of Notary Public

Place Notary Seal Above

OPTIONAL

Though this section is optional, completing this information can deter alteration of the document or fraudulent reattachment of this form to an unintended document.

Description of Attached Document

Title or Type of Document: Performance Bond No. 7646003 Document Date: 08/11/2015
Number of Pages: One (1) Signer(s) Other Than Named Above: All American Asphalt

Capacity(ies) Claimed by Signer(s)

Signer's Name: Rebecca Haas-Bates
 Corporate Officer — Title(s): _____
 Partner — Limited General
 Individual Attorney in Fact
 Trustee Guardian or Conservator
 Other: _____

Signer's Name: _____
 Corporate Officer — Title(s): _____
 Partner — Limited General
 Individual Attorney in Fact
 Trustee Guardian or Conservator
 Other: _____

Signer Is Representing: _____
Fidelity and Deposit Company of Maryland

Signer Is Representing: _____

EXTRACT FROM BY-LAWS OF THE COMPANIES

"Article V, Section 8, Attorneys-in-Fact. The Chief Executive Officer, the President, or any Executive Vice President or Vice President may, by written instrument under the attested corporate seal, appoint attorneys-in-fact with authority to execute bonds, policies, recognizances, stipulations, undertakings, or other like instruments on behalf of the Company, and may authorize any officer or any such attorney-in-fact to affix the corporate seal thereto; and may with or without cause modify or revoke any such appointment or authority at any time."

CERTIFICATE

I, the undersigned, Vice President of the ZURICH AMERICAN INSURANCE COMPANY, the COLONIAL AMERICAN CASUALTY AND SURETY COMPANY, and the FIDELITY AND DEPOSIT COMPANY OF MARYLAND, do hereby certify that the foregoing Power of Attorney is still in full force and effect on the date of this certificate; and I do further certify that Article V, Section 8, of the By-Laws of the Companies is still in force.

This Power of Attorney and Certificate may be signed by facsimile under and by authority of the following resolution of the Board of Directors of the ZURICH AMERICAN INSURANCE COMPANY at a meeting duly called and held on the 15th day of December 1998.

RESOLVED: "That the signature of the President or a Vice President and the attesting signature of a Secretary or an Assistant Secretary and the Seal of the Company may be affixed by facsimile on any Power of Attorney...Any such Power or any certificate thereof bearing such facsimile signature and seal shall be valid and binding on the Company."

This Power of Attorney and Certificate may be signed by facsimile under and by authority of the following resolution of the Board of Directors of the COLONIAL AMERICAN CASUALTY AND SURETY COMPANY at a meeting duly called and held on the 5th day of May, 1994, and the following resolution of the Board of Directors of the FIDELITY AND DEPOSIT COMPANY OF MARYLAND at a meeting duly called and held on the 10th day of May, 1990.

RESOLVED: "That the facsimile or mechanically reproduced seal of the company and facsimile or mechanically reproduced signature of any Vice-President, Secretary, or Assistant Secretary of the Company, whether made heretofore or hereafter, wherever appearing upon a certified copy of any power of attorney issued by the Company, shall be valid and binding upon the Company with the same force and effect as though manually affixed.

IN TESTIMONY WHEREOF, I have hereunto subscribed my name and affixed the corporate seals of the said Companies, this 11th day of August, 2015.



A handwritten signature in cursive script, reading 'Thomas O. McClellan', is written over a horizontal line.

Thomas O. McClellan, Vice President

PRF7646003

Bond Number

County of Riverside

Obligee

ZURICH AMERICAN INSURANCE COMPANY
COLONIAL AMERICAN CASUALTY AND SURETY COMPANY
FIDELITY AND DEPOSIT COMPANY OF MARYLAND
POWER OF ATTORNEY

KNOW ALL MEN BY THESE PRESENTS: That the ZURICH AMERICAN INSURANCE COMPANY, a corporation of the State of New York, the COLONIAL AMERICAN CASUALTY AND SURETY COMPANY, a corporation of the State of Maryland, and the FIDELITY AND DEPOSIT COMPANY OF MARYLAND a corporation of the State of Maryland (herein collectively called the "Companies"), by Michael P. Bond, Vice President, in pursuance of authority granted by Article V, Section 8, of the By-Laws of said Companies, which are set forth on the reverse side hereof and are hereby certified to be in full force and effect on the date hereof, do hereby nominate, constitute, and appoint Rebecca Haas-Bates, its true and lawful agent and Attorney-in-Fact, to make, execute, seal and deliver, for, and on its behalf as surety, and as its act and deed: any and all bonds and undertakings, and the execution of such bonds or undertakings in pursuance of these presents, shall be as binding upon said Companies, as fully and amply, to all intents and purposes, as if they had been duly executed and acknowledged by the regularly elected officers of the ZURICH AMERICAN INSURANCE COMPANY at its office in New York, New York., the regularly elected officers of the COLONIAL AMERICAN CASUALTY AND SURETY COMPANY at its office in Owings Mills, Maryland., and the regularly elected officers of the FIDELITY AND DEPOSIT COMPANY OF MARYLAND at its office in Owings Mills, Maryland., in their own proper persons.

The said Vice President does hereby certify that the extract set forth on the reverse side hereof is a true copy of Article V, Section 8, of the By-Laws of said Companies, and is now in force.

IN WITNESS WHEREOF, the said Vice-President has hereunto subscribed his/her names and affixed the Corporate Seals of the said ZURICH AMERICAN INSURANCE COMPANY, COLONIAL AMERICAN CASUALTY AND SURETY COMPANY, and FIDELITY AND DEPOSIT COMPANY OF MARYLAND, this 11th day of August, A.D. 2015.

ATTEST:
ZURICH AMERICAN INSURANCE COMPANY
COLONIAL AMERICAN CASUALTY AND SURETY COMPANY
FIDELITY AND DEPOSIT COMPANY OF MARYLAND



By: Gerald F. Haley, Secretary; Michael P. Bond, Vice President

State of Maryland
County of Baltimore

On this 11th day of August, A.D. 2015, before the subscriber, a Notary Public of the State of Maryland, duly commissioned and qualified, Michael P. Bond, Vice President and Gerald F. Haley, Secretary of the Companies, to me personally known to be the individuals and officers described in and who executed the preceding instrument, and acknowledged the execution of same, and being by me duly sworn, depose and saith, that he/she is the said officer of the Company aforesaid, and that the seals affixed to the preceding instrument are the Corporate Seals of said Companies, and that the said Corporate Seals and the signature as such officer were duly affixed and subscribed to the said instrument by the authority and direction of the said Corporations.

IN TESTIMONY WHEREOF, I have hereunto set my hand and affixed my Official Seal the day and year first above written.



Constance A. Dunn

Constance A. Dunn, Notary Public
My Commission Expires: July 9, 2019



- Company Profile
- Company Search
- Company Information
- Old Company Names
- Agent for Service
- Reference Information
- NAIC Group List
- Lines of Business
- Workers' Compensation
- Complaint and Request for Action/Appeals
- Contact Information
- Financial Statements PDF's
- Annual Statements
- Quarterly Statements
- Company Complaint
- Company Performance & Comparison Data
- Company Enforcement Action
- Composite Complaints Studies
- Additional Info
- Find A Company Representative In Your Area
- View Financial Disclaimer

COMPANY PROFILE

Company Information

FIDELITY AND DEPOSIT COMPANY OF MARYLAND
1400 AMERICAN LANE, 19TH FLOOR
SCHUAMBURG, IL 60196-1056
800-382-2150

Old Company Names

Effective Date

Agent For Service

KARISSA LOWRY
 C/O CORPORATION SERVICE COMPANY
 2710 GATEWAY OAKS DRIVE, SUITE 150N
 SACRAMENTO CA 95833

Reference Information

NAIC #:	39306
California Company ID #:	2479-4
Date Authorized in California:	01/01/1982
License Status:	UNLIMITED-NORMAL
Company Type:	Property & Casualty
State of Domicile:	MARYLAND

[back to top](#)

NAIC Group List

NAIC Group #: **0212** ZURICH INS GRP

Lines Of Business

The company is authorized to transact business within these lines of insurance. For an explanation of any of these terms, please refer to the [glossary](#).

- AIRCRAFT
- AUTOMOBILE
- BOILER AND MACHINERY
- BURGLARY
- CREDIT
- FIRE
- LIABILITY
- MARINE
- MISCELLANEOUS
- PLATE GLASS
- SPRINKLER
- SURETY
- TEAM AND VEHICLE
- WORKERS' COMPENSATION

[back to top](#)

Bond No. 7646003
Premium is included in the performance bond.
Executed in: 2 Counterparts

Payment Bond
(Public Works - Civil Code §9550 et seq.)

The makers of this Bond are All American Asphalt, as Principal and Original Contractor and Fidelity and Deposit Company of Maryland, a corporation, authorized to issue Surety Bonds in California, as Surety, and this Bond is issued in conjunction with that certain public works contract to be executed between Principal and COUNTY OF RIVERSIDE a public entity, as Owner, for \$361,156.00 (Three hundred sixty one thousand, one hundred fifty six dollars and zero cents), the total amount payable. The amount of this bond is one hundred percent (100%) of said sum. Said contract is for public work generally consisting of El Cerrito, Hemet and Perris Maintenance Yards Pavement Resurfacing Project, Project No. 15-00008.

The beneficiaries of this Bond are as is stated in 9554 of the Civil Code and requirements and conditions of this Bond are as is set forth in 9554, 9558, 9560 and 9564 of said code. Without notice, Surety consents to extension of time for performance, change in requirements, amount of compensation, or prepayment under said contract.

Dated: August 11, 2015

All American Asphalt
Original Contractor – Principal

Fidelity and Deposit Company of Maryland
Surety

By  _____

By Rebecca Haas-Bates
Rebecca Haas-Bates
Its Attorney In Fact

Title Edward J. Carlson Vice President
(If corporation, affix seal)

(Corporate Seal)

(Corporate Seal)

STATE OF **Please See Attached**
COUNTY OF _____

} ss. SURETY'S ACKNOWLEDGEMENT

On _____ before me, _____ personally appeared, _____, known to me, or proved to me on the basis of satisfactory evidence, to be the person whose name is subscribed to the within instrument and acknowledged to me that he executed the same in his authorized capacities, and that by his signature on the instrument the person, or the entity upon behalf of which the person acted, executed the instrument.

WITNESS my hand and official seal.

Signature of Notary Public

Notary Public (Seal)

NOTE: This Bond must be executed by both parties with corporate seal affixed. All signatures must be acknowledged. (Attach acknowledgements).

CALIFORNIA ALL-PURPOSE ACKNOWLEDGEMENT

CIVIL CODE § 1189

A notary public or other officer completing this certificate verifies only the identity of the individual who signed the document to which this certificate is attached, and not the truthfulness, accuracy, or validity of that document.

State of California

County of Riverside

On 8/13/2015 before me, Rebecca Angela Parra, Notary Public
Date Here Insert name and Title of the Officer

personally appeared Edward J. Carlson
Name(s) of Signer(s)

who proved to me on the basis of satisfactory evidence to be the person(s) whose name(s) is/are subscribed to the within instrument and acknowledged to me that he/she/they executed the same in his/her/their authorized capacity(ies), and that by his/her/their signature(s) on the instrument the person(s), or the entity upon behalf of which the person(s) acted, executed the instrument.

I certify under PENALTY OF PERJURY under the laws of the State of California that the forgoing paragraph is true and correct.

WITNESS my hand and official seal.

Signature Rebecca Angela Parra
Signature of Notary Public



Place Notary Seal Above

OPTIONAL

Though the information below is not required by law, it may prove valuable to person relying on the document and could prevent fraudulent removal and reattachment of this form to another document.

Description of Attached Document

Title or Type of Document Payment Bond No. 7646003

Document Date: 8/11/2015 Number of Pages: One (1)

Signer(s) Other Than Named Above: Fidelity and Deposit Company of Maryland

Capacity(ies) Claimed by Signer(s)

Signer's Name: Edward J. Carlson

- Individual
- Corporate Officer — Title(s): Vice President
- Partner Limited General
- Attorney in Fact
- Trustee
- Other: _____

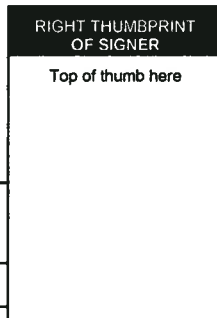

Signer is Representing:

All American Asphalt

Signer's Name: _____

- Individual
- Corporate Officer — Title(s): _____
- Partner Limited General
- Attorney in Fact
- Trustee
- Other: _____

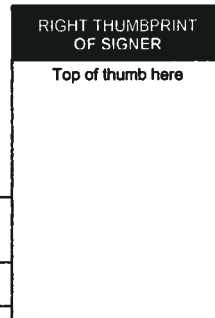

Signer is Representing:

CALIFORNIA ALL-PURPOSE ACKNOWLEDGMENT

CIVIL CODE § 1189

A notary public or other officer completing this certificate verifies only the identity of the individual who signed the document to which this certificate is attached, and not the truthfulness, accuracy, or validity of that document.

State of California)
County of Orange)

On 08/11/2015 before me, R. Paramo, Notary Public
Date Here Insert Name and Title of the Officer

personally appeared Rebecca Haas-Bates
Name(s) of Signer(s)

who proved to me on the basis of satisfactory evidence to be the person(s) whose name(s) is/are subscribed to the within instrument and acknowledged to me that he/she/they executed the same in his/her/their authorized capacity(ies), and that by his/her/their signature(s) on the instrument the person(s), or the entity upon behalf of which the person(s) acted, executed the instrument.

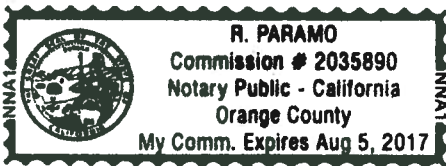

I certify under PENALTY OF PERJURY under the laws of the State of California that the foregoing paragraph is true and correct.

WITNESS my hand and official seal.

Signature [Handwritten Signature]
Signature of Notary Public

Place Notary Seal Above

OPTIONAL

Though this section is optional, completing this information can deter alteration of the document or fraudulent reattachment of this form to an unintended document.

Description of Attached Document

Title or Type of Document: Payment Bond No. 7646003 Document Date: 08/11/2015
Number of Pages: One (1) Signer(s) Other Than Named Above: All American Asphalt

Capacity(ies) Claimed by Signer(s)

Signer's Name: Rebecca Haas-Bates
 Corporate Officer — Title(s): _____
 Partner — Limited General
 Individual Attorney in Fact
 Trustee Guardian or Conservator
 Other: _____

Signer's Name: _____
 Corporate Officer — Title(s): _____
 Partner — Limited General
 Individual Attorney in Fact
 Trustee Guardian or Conservator
 Other: _____

Signer Is Representing: _____
Fidelity and Deposit Company of Maryland

Signer Is Representing: _____

EXTRACT FROM BY-LAWS OF THE COMPANIES

"Article V, Section 8, Attorneys-in-Fact. The Chief Executive Officer, the President, or any Executive Vice President or Vice President may, by written instrument under the attested corporate seal, appoint attorneys-in-fact with authority to execute bonds, policies, recognizances, stipulations, undertakings, or other like instruments on behalf of the Company, and may authorize any officer or any such attorney-in-fact to affix the corporate seal thereto; and may with or without cause modify or revoke any such appointment or authority at any time."

CERTIFICATE

I, the undersigned, Vice President of the ZURICH AMERICAN INSURANCE COMPANY, the COLONIAL AMERICAN CASUALTY AND SURETY COMPANY, and the FIDELITY AND DEPOSIT COMPANY OF MARYLAND, do hereby certify that the foregoing Power of Attorney is still in full force and effect on the date of this certificate; and I do further certify that Article V, Section 8, of the By-Laws of the Companies is still in force.

This Power of Attorney and Certificate may be signed by facsimile under and by authority of the following resolution of the Board of Directors of the ZURICH AMERICAN INSURANCE COMPANY at a meeting duly called and held on the 15th day of December 1998.

RESOLVED: "That the signature of the President or a Vice President and the attesting signature of a Secretary or an Assistant Secretary and the Seal of the Company may be affixed by facsimile on any Power of Attorney...Any such Power or any certificate thereof bearing such facsimile signature and seal shall be valid and binding on the Company."

This Power of Attorney and Certificate may be signed by facsimile under and by authority of the following resolution of the Board of Directors of the COLONIAL AMERICAN CASUALTY AND SURETY COMPANY at a meeting duly called and held on the 5th day of May, 1994, and the following resolution of the Board of Directors of the FIDELITY AND DEPOSIT COMPANY OF MARYLAND at a meeting duly called and held on the 10th day of May, 1990.

RESOLVED: "That the facsimile or mechanically reproduced seal of the company and facsimile or mechanically reproduced signature of any Vice-President, Secretary, or Assistant Secretary of the Company, whether made heretofore or hereafter, wherever appearing upon a certified copy of any power of attorney issued by the Company, shall be valid and binding upon the Company with the same force and effect as though manually affixed.

IN TESTIMONY WHEREOF, I have hereunto subscribed my name and affixed the corporate seals of the said Companies, this 11th day of August, 2015.



Thomas O. McClellan

Thomas O. McClellan, Vice President

PRF7646003

Bond Number

County of Riverside

Obligee

ZURICH AMERICAN INSURANCE COMPANY
COLONIAL AMERICAN CASUALTY AND SURETY COMPANY
FIDELITY AND DEPOSIT COMPANY OF MARYLAND
POWER OF ATTORNEY

KNOW ALL MEN BY THESE PRESENTS: That the ZURICH AMERICAN INSURANCE COMPANY, a corporation of the State of New York, the COLONIAL AMERICAN CASUALTY AND SURETY COMPANY, a corporation of the State of Maryland, and the FIDELITY AND DEPOSIT COMPANY OF MARYLAND a corporation of the State of Maryland (herein collectively called the "Companies"), by Michael P. Bond, Vice President, in pursuance of authority granted by Article V, Section 8, of the By-Laws of said Companies, which are set forth on the reverse side hereof and are hereby certified to be in full force and effect on the date hereof, do hereby nominate, constitute, and appoint Rebecca Haas-Bates, its true and lawful agent and Attorney-in-Fact, to make, execute, seal and deliver, for, and on its behalf as surety, and as its act and deed: any and all bonds and undertakings, and the execution of such bonds or undertakings in pursuance of these presents, shall be as binding upon said Companies, as fully and amply, to all intents and purposes, as if they had been duly executed and acknowledged by the regularly elected officers of the ZURICH AMERICAN INSURANCE COMPANY at its office in New York, New York., the regularly elected officers of the COLONIAL AMERICAN CASUALTY AND SURETY COMPANY at its office in Owings Mills, Maryland., and the regularly elected officers of the FIDELITY AND DEPOSIT COMPANY OF MARYLAND at its office in Owings Mills, Maryland., in their own proper persons.

The said Vice President does hereby certify that the extract set forth on the reverse side hereof is a true copy of Article V, Section 8, of the By-Laws of said Companies, and is now in force.

IN WITNESS WHEREOF, the said Vice-President has hereunto subscribed his/her names and affixed the Corporate Seals of the said ZURICH AMERICAN INSURANCE COMPANY, COLONIAL AMERICAN CASUALTY AND SURETY COMPANY, and FIDELITY AND DEPOSIT COMPANY OF MARYLAND, this 11th day of August, A.D. 2015.

ATTEST:
ZURICH AMERICAN INSURANCE COMPANY
COLONIAL AMERICAN CASUALTY AND SURETY COMPANY
FIDELITY AND DEPOSIT COMPANY OF MARYLAND



By: Gerald F. Haley, Secretary; Michael P. Bond, Vice President

State of Maryland
County of Baltimore

On this 11th day of August, A.D. 2015, before the subscriber, a Notary Public of the State of Maryland, duly commissioned and qualified, Michael P. Bond, Vice President and Gerald F. Haley, Secretary of the Companies, to me personally known to be the individuals and officers described in and who executed the preceding instrument, and acknowledged the execution of same, and being by me duly sworn, depose and saith, that he/she is the said officer of the Company aforesaid, and that the seals affixed to the preceding instrument are the Corporate Seals of said Companies, and that the said Corporate Seals and the signature as such officer were duly affixed and subscribed to the said instrument by the authority and direction of the said Corporations.

IN TESTIMONY WHEREOF, I have hereunto set my hand and affixed my Official Seal the day and year first above written.



Constance A. Dunn

Constance A. Dunn, Notary Public
My Commission Expires: July 9, 2019



- Company Profile
- Company Search
- Company Information
- Old Company Names
- Agent for Service
- Reference Information
- NAIC Group List
- Lines of Business
- Workers' Compensation
- Complaint and Request for Action/Appeals
- Contact Information
- Financial Statements PDF's
- Annual Statements
- Quarterly Statements
- Company Complaint
- Company Performance & Comparison Data
- Company Enforcement Action
- Composite Complaints Studies
- Additional Info
- Find A Company Representative In Your Area
- View Financial Disclaimer

COMPANY PROFILE

Company Information

FIDELITY AND DEPOSIT COMPANY OF MARYLAND
1400 AMERICAN LANE, 19TH FLOOR
SCHUAMBURG, IL 60196-1056
800-382-2150

Old Company Names

Effective Date

Agent For Service

KARISSA LOWRY
 C/O CORPORATION SERVICE COMPANY
 2710 GATEWAY OAKS DRIVE, SUITE 150N
 SACRAMENTO CA 95833

Reference Information

NAIC #:	39306
California Company ID #:	2479-4
Date Authorized in California:	01/01/1982
License Status:	UNLIMITED-NORMAL
Company Type:	Property & Casualty
State of Domicile:	MARYLAND

[back to top](#)

NAIC Group List

NAIC Group #: **0212** ZURICH INS GRP

Lines Of Business

The company is authorized to transact business within these lines of insurance. For an explanation of any of these terms, please refer to the [glossary](#).

- AIRCRAFT
- AUTOMOBILE
- BOILER AND MACHINERY
- BURGLARY
- CREDIT
- FIRE
- LIABILITY
- MARINE
- MISCELLANEOUS
- PLATE GLASS
- SPRINKLER
- SURETY
- TEAM AND VEHICLE
- WORKERS' COMPENSATION

[back to top](#)



CERTIFICATE OF LIABILITY INSURANCE

DATE (MM/DD/YYYY)
08/13/2015

THIS CERTIFICATE IS ISSUED AS A MATTER OF INFORMATION ONLY AND CONFERS NO RIGHTS UPON THE CERTIFICATE HOLDER. THIS CERTIFICATE DOES NOT AFFIRMATIVELY OR NEGATIVELY AMEND, EXTEND OR ALTER THE COVERAGE AFFORDED BY THE POLICIES BELOW. THIS CERTIFICATE OF INSURANCE DOES NOT CONSTITUTE A CONTRACT BETWEEN THE ISSUING INSURER(S), AUTHORIZED REPRESENTATIVE OR PRODUCER, AND THE CERTIFICATE HOLDER.

IMPORTANT: If the certificate holder is an ADDITIONAL INSURED, the policy(ies) must be endorsed. If SUBROGATION IS WAIVED, subject to the terms and conditions of the policy, certain policies may require an endorsement. A statement on this certificate does not confer rights to the certificate holder in lieu of such endorsement(s).

PRODUCER CA LIC 0B29370 Edgewood Partners Insurance Centers (EPIC) [Inland Empire - Branch ID 14542] P.O. Box 5003 San Ramon, CA 94583	1-925-244-7700	CONTACT NAME: Certificates Department PHONE (A/C. No. Ext): (925) 244-7700 E-MAIL ADDRESS: EPICcerts@epicbrokers.com	FAX (A/C. No): (925) 901-0671
INSURED All American Asphalt P.O. Box 2229 Corona, CA 92878-2229		INSURER(S) AFFORDING COVERAGE	
		INSURER A: ARCH SPECIALTY INS CO	NAIC # 21199
		INSURER B: ZURICH AMER INS CO	16535
		INSURER C: NATIONAL UNION FIRE INS CO OF PITTS	19445
		INSURER D:	
		INSURER E:	
		INSURER F:	

COVERAGES

CERTIFICATE NUMBER: 44787131

REVISION NUMBER:

THIS IS TO CERTIFY THAT THE POLICIES OF INSURANCE LISTED BELOW HAVE BEEN ISSUED TO THE INSURED NAMED ABOVE FOR THE POLICY PERIOD INDICATED. NOTWITHSTANDING ANY REQUIREMENT, TERM OR CONDITION OF ANY CONTRACT OR OTHER DOCUMENT WITH RESPECT TO WHICH THIS CERTIFICATE MAY BE ISSUED OR MAY PERTAIN, THE INSURANCE AFFORDED BY THE POLICIES DESCRIBED HEREIN IS SUBJECT TO ALL THE TERMS, EXCLUSIONS AND CONDITIONS OF SUCH POLICIES. LIMITS SHOWN MAY HAVE BEEN REDUCED BY PAID CLAIMS.

INSR LTR	TYPE OF INSURANCE	ADDL INSD	SUBR WVD	POLICY NUMBER	POLICY EFF (MM/DD/YYYY)	POLICY EXP (MM/DD/YYYY)	LIMITS
A	<input checked="" type="checkbox"/> COMMERCIAL GENERAL LIABILITY <input type="checkbox"/> CLAIMS-MADE <input checked="" type="checkbox"/> OCCUR GEN'L AGGREGATE LIMIT APPLIES PER: <input type="checkbox"/> POLICY <input checked="" type="checkbox"/> PRO-JECT <input type="checkbox"/> LOC <input type="checkbox"/> OTHER:	X	X	GPP002265807	08/01/15	08/01/16	EACH OCCURRENCE \$ 1,000,000 DAMAGE TO RENTED PREMISES (Ea occurrence) \$ 100,000 MED EXP (Any one person) \$ PERSONAL & ADV INJURY \$ 1,000,000 GENERAL AGGREGATE \$ 2,000,000 PRODUCTS - COMP/OP AGG \$ 2,000,000 \$
B	<input checked="" type="checkbox"/> AUTOMOBILE LIABILITY <input checked="" type="checkbox"/> ANY AUTO <input type="checkbox"/> ALL OWNED AUTOS <input type="checkbox"/> SCHEDULED AUTOS <input checked="" type="checkbox"/> HIRED AUTOS <input checked="" type="checkbox"/> NON-OWNED AUTOS	X	X	BAP557108803	08/01/15	08/01/16	COMBINED SINGLE LIMIT (Ea accident) \$ 2,000,000 BODILY INJURY (Per person) \$ BODILY INJURY (Per accident) \$ PROPERTY DAMAGE (Per accident) \$ \$
C	<input type="checkbox"/> UMBRELLA LIAB <input checked="" type="checkbox"/> OCCUR <input checked="" type="checkbox"/> EXCESS LIAB <input type="checkbox"/> CLAIMS-MADE <input type="checkbox"/> DED <input checked="" type="checkbox"/> RETENTION \$ 10,000	X	X	BE11665655	08/01/15	08/01/16	EACH OCCURRENCE \$ 25,000,000 AGGREGATE \$ 25,000,000 Following-Form \$
B	WORKERS COMPENSATION AND EMPLOYERS' LIABILITY ANY PROPRIETOR/PARTNER/EXECUTIVE OFFICER/MEMBER EXCLUDED? (Mandatory in NH) If yes, describe under DESCRIPTION OF OPERATIONS below			WC593205702	08/01/15	08/01/16	<input checked="" type="checkbox"/> PER STATUTE <input type="checkbox"/> OTH-ER E.L. EACH ACCIDENT \$ 1,000,000 E.L. DISEASE - EA EMPLOYEE \$ 1,000,000 E.L. DISEASE - POLICY LIMIT \$ 1,000,000
DESCRIPTION OF OPERATIONS / LOCATIONS / VEHICLES (ACORD 101, Additional Remarks Schedule, may be attached if more space is required) Project #15-00008 / RE: El Cerrito, Hemet and Perris Maintenance Yards Pavement Resurfacing Project							

Certificate Holder is Additional Insured if Required by Written Contract Excluding Workers Compensation [16]

CERTIFICATE HOLDER**CANCELLATION**

County of Riverside Transportation and Land Management Agency 3525 14th Street Riverside, CA 92501 USA	SHOULD ANY OF THE ABOVE DESCRIBED POLICIES BE CANCELLED BEFORE THE EXPIRATION DATE THEREOF, NOTICE WILL BE DELIVERED IN ACCORDANCE WITH THE POLICY PROVISIONS. AUTHORIZED REPRESENTATIVE 
--	--

© 1988-2014 ACORD CORPORATION. All rights reserved.



MEMO

To:	Whom it may concern
From:	Edgewood Partners Insurance Centers (EPIC)
Named Insured:	All American Asphalt et al
Policy Number(s):	GPP0022658-07, BAP5571088-03, WC5932057-02, BE11665655
RE:	Notice of Cancellation

Should the above described policy be cancelled before the expiration date thereof, we will mail 30 days written notice to the Certificate Holder; except, 10 days notice for non-payment of premium.

Sincerely,

Kathy Lopez

Account Manager

THIS ENDORSEMENT CHANGES THE POLICY. PLEASE READ IT CAREFULLY.

BLANKET ADDITIONAL INSURED ENDORSEMENT

This endorsement modifies insurance provided under the following:

COMMERCIAL GENERAL LIABILITY COVERAGE FORM
COMMERCIAL GENERAL LIABILITY SELF-INSURED RETENTION COVERAGE FORM

SECTION II – WHO IS AN INSURED is amended to include as an additional insured those persons or organizations who are required under a written contract with you to be named as an additional insured, but only with respect to liability for "bodily injury", "property damage", or "personal and advertising injury" caused, in whole or in part, by your acts or omissions or the acts or omissions of your subcontractors:

- A. In the performance of your ongoing operations or "your work", including "your work" that has been completed; or
- B. In connection with your premises owned by or rented to you.

As used in this endorsement, the words "you" and "your" refer to the Named Insured.

All other terms and conditions of this Policy remain unchanged.

Schedule	Project
County of Riverside, its directors, officers, elected and appointed officials, employees, agents and representatives	Project #15-00008 / RE: El Cerrito, Hemet and Perris Maintenance Yards Pavement Resurfacing Project

Endorsement Number:

This endorsement is effective on the inception date of this policy unless otherwise stated herein.

(The information below is required only when this endorsement is issued subsequent to preparation of the policy.)

Policy Number: GPP0022658-07

Named Insured: All American Asphalt et al

Endorsement Effective Date: August 1, 2015



THIS ENDORSEMENT CHANGES THE POLICY. PLEASE READ IT CAREFULLY.

OTHER INSURANCE - BROAD FORM, CGL POLICY ENDORSEMENT

This endorsement modifies insurance provided under the following:

COMMERCIAL GENERAL LIABILITY COVERAGE FORM

Under **SECTION IV – COMMERCIAL GENERAL LIABILITY CONDITIONS**, the following paragraph is added to Condition 4. **Other Insurance**:

Where the Named Insured is required by a written contract to provide insurance that is primary and non-contributory, and the written contract so requiring is executed by the Named Insured before any "occurrence" or offense, this insurance will be primary, but only if and to the extent required by that written contract.

All other terms and conditions of this Policy remain unchanged.

Schedule

County of Riverside, its directors, officers, elected and appointed officials, employees, agents and representatives

Project

Project #15-00008 / RE: El Cerrito, Hemet and Perris Maintenance Yards Pavement Resurfacing Project

Endorsement Number

This endorsement is effective on the inception date of this policy unless otherwise stated herein.

(The information below is required only when this endorsement is issued subsequent to preparation of the policy.)

Policy Number: GPP0022658-07

Named Insured: All American Asphalt et al

Endorsement Effective Date August 1, 2015



THIS ENDORSEMENT CHANGES THE POLICY. PLEASE READ IT CAREFULLY.

WAIVER OF SUBROGATION ENDORSEMENT

This endorsement modifies Insurance provided under the following:

COMMERCIAL GENERAL LIABILITY COVERAGE FORM
COMMERCIAL GENERAL LIABILITY SELF-INSURED RETENTION COVERAGE FORM

SCHEDULE

Name of Person or Organization: Where required by written contract.

Under **SECTION IV – COMMERCIAL GENERAL LIABILITY CONDITIONS, Condition B. Transfer Of Rights Of Recovery Against Others To Us** is amended by the addition of the following provision:

We waive any right of recovery we may have against the person or organization shown in the **SCHEDULE** above because of payments we make for injury or damage arising out of your operations or "your work" done under a written contract with that person or organization.

All other terms and conditions of this Policy remain unchanged.

Schedule

County of Riverside, its directors, officers, elected and appointed officials, employees, agents and representatives

Project

Project #15-00008 / RE: El Cerrito, Hemet and Perris Maintenance Yards Pavement Resurfacing Project

Endorsement Number:

This endorsement is effective on the inception date of this policy unless otherwise stated herein.

(The information below is required only when this endorsement is issued subsequent to preparation of the policy.)

Policy Number: GPP002265-07

Named Insured: All American Asphalt et al

Endorsement Effective Date: August 1, 2015



THIS ENDORSEMENT CHANGES THE POLICY. PLEASE READ IT CAREFULLY.

DESIGNATED INSURED

This endorsement modifies insurance provided under the following:

- BUSINESS AUTO COVERAGE FORM
- GARAGE COVERAGE FORM
- MOTOR CARRIER COVERAGE FORM
- TRUCKERS COVERAGE FORM

With respect to coverage provided by this endorsement, the provisions of the Coverage Form apply unless modified by this endorsement.

This endorsement identifies person(s) or organization(s) who are "insureds" under the Who Is An Insured Provision of the Coverage Form. This endorsement does not alter coverage provided in the Coverage Form.

This endorsement changes the policy effective on the inception date of the policy unless another date is indicated below.

Endorsement Effective: 8/1/15	Countersigned By:  (Authorized Representative)
Named Insured: All American Asphalt	

SCHEDULE

Name of Person(s) or Organization(s):

ANY PERSON OR ORGANIZATION TO WHOM OR WHICH YOU ARE REQUIRED TO PROVIDE ADDITIONAL INSURED STATUS OR ADDITIONAL INSURED STATUS ON A PRIMARY, NON-CONTRIBUTORY BASIS, IN A WRITTEN CONTRACT OR WRITTEN AGREEMENT EXECUTED PRIOR TO LOSS, EXCEPT WHERE SUCH CONTRACT OR AGREEMENT IS PROHIBITED BY LAW.

Schedule

Project

County of Riverside, its directors, officers, elected and appointed officials, employees, agents and representatives

Project #15-00008 / RE: El Cerrito, Hemet and Perris Maintenance Yards Pavement Resurfacing Project

(If no entry appears above, information required to complete this endorsement will be shown in the Declarations as applicable to the endorsement.)

Each person or organization shown in the Schedule is an "insured" for Liability Coverage, but only to the extent that person or organization qualifies as an "insured" under the Who Is An Insured Provision contained in Section II of the Coverage Form.

THIS ENDORSEMENT CHANGES THE POLICY. PLEASE READ IT CAREFULLY.

WAIVER OF TRANSFER OF RIGHTS OF RECOVERY AGAINST OTHERS TO US (WAIVER OF SUBROGATION)

This endorsement modifies insurance provided under the following:

- BUSINESS AUTO COVERAGE FORM
- BUSINESS AUTO PHYSICAL DAMAGE COVERAGE FORM
- GARAGE COVERAGE FORM
- MOTOR CARRIER COVERAGE FORM
- TRUCKERS COVERAGE FORM

With respect to coverage provided by this endorsement, the provisions of the Coverage Form apply unless modified by the endorsement.

This endorsement changes the policy effective on the inception date of the policy unless another date is indicated below.

Named Insured: All American Asphalt
Endorsement Effective Date: 8/1/15

SCHEDULE

Name(s) Of Person(s) Or Organization(s): ALL PERSONS AND/OR ORGANIZATIONS THAT ARE REQUIRED BY WRITTEN CONTRACT OR AGREEMENT WITH THE INSURED, EXECUTED PRIOR TO THE ACCIDENT OR LOSS, THAT WAIVER OF SUBROGATION BE PROVIDED UNDER THIS POLICY

Information required to complete this Schedule, if not shown above, will be shown in the Declarations.

The Transfer Of Rights Of Recovery Against Others To Us Condition does not apply to the person(s) or organization(s) shown in the Schedule, but only to the extent that subrogation is waived prior to the "accident" or the "loss" under a contract with that person or organization.

Schedule

County of Riverside, its directors, officers, elected and appointed officials, employees, agents and representatives

Project

Project #15-00008 / RE: El Cerrito, Hemet and Perris Maintenance Yards Pavement Resurfacing Project



**WAIVER OF OUR RIGHT TO RECOVER FROM OTHERS ENDORSEMENT—
CALIFORNIA**

We have the right to recover our payments from anyone liable for an injury covered by this policy. We will not enforce our right against the person or organization named in the Schedule. (This agreement applies only to the extent that you perform work under a written contract that requires you to obtain this agreement from us.)

You must maintain payroll records accurately segregating the remuneration of your employees while engaged in the work described in the Schedule.

The additional premium for this endorsement shall be 0.00 % of the California workers' compensation premium otherwise due on such remuneration.

Schedule

Person or Organization
ALL PERSONS AND/OR ORGANIZATIONS THAT ARE REQUIRED BY WRITTEN CONTRACT OR AGREEMENT WITH THE INSURED, EXECUTED PRIOR TO THE ACCIDENT OR LOSS, THAT WAIVER OF SUBROGATION BE PROVIDED UNDER THIS POLICY FOR WORK PERFORMED BY YOU FOR THAT PERSON AND/OR ORGANIZATION

Job Description
ALL CA OPERATION

County of Riverside, its directors, officers, elected and appointed officials, employees, agents and representatives

Project #15-00008 / RE: El Cerrito, Hemet and Perris Maintenance Yards Pavement Resurfacing Project



All American Asphalt
Policy #WC5932057-02
8/1/15

Zurich American Ins. Co.

121 SPEAR STREET
TWO RINCON CENTER
SAN FRANCISCO, CA 94105

WHOLESALE TRADING CO-OP INSURANCE SERVICES LLC
135 MAIN STREET
SUITE 1875
SAN FRANCISCO, CA 94105
Attention To: Kris Bauer
Phone: 415-442-8501
Fax:
Email: kbauer@wtcis.com



RE: Excess Liability Binder for ALL AMERICAN ASPHALT

Dear Kris:

We are pleased to advise that coverage is bound for the captioned account according to the following terms:

Insured Address: 1776 ALL AMERICAN WAY
CORONA, CA 91718

Policy Period: From: August 1, 2015 To: August 1, 2016
(At 12:01 A.M., standard time, at the address of the Insured stated above)

Carrier: NATIONAL UNION FIRE INSURANCE COMPANY OF PITTSBURGH, PA.

Policy Form: 60225 (10/04) and attachments

Policy Number: BE 11665655 **Renewal Of:** 11665589

Limits: \$25,000,000 Each Occurrence
\$25,000,000 Aggregate

EXCESS LIABILITY POLICY FORM

Various provisions in this policy restrict coverage. Read the entire policy carefully to determine rights, duties and what is and is not covered.

Throughout this policy, the words "you" and "your" refer to the Named Insured as shown in Item 1 of the Declarations. The words "we", "us" and "our" refer to the Company providing this insurance.

In consideration of the payment of the premium and in reliance upon the statements in the Declarations, we agree with you to provide coverage as follows:

INSURING AGREEMENTS

I. Coverage

A. We will pay on your behalf the Ultimate Net Loss in excess of the Underlying Insurance as shown in Item 4 of the Declarations, but only up to an amount not exceeding our Limits of Insurance as shown in Item 3 of the Declarations. Except for the terms, definitions, conditions and exclusions of this policy, the coverage provided by this policy shall follow the terms, definitions, conditions and exclusions of the First Underlying Insurance Policy as shown in Item 4 of the Declarations.

B. The Limits of Insurance shown in Item 3 of the Declarations state the most we will pay regardless of the number of Insureds, claims made or suits brought or persons or organizations making claims or bringing suits.

C. Maintenance of Underlying Insurance

The limits of insurance of the Underlying Insurance shown in Item 4 of the Declarations shall be maintained in full effect during the period of this policy except for any reduction or exhaustion of aggregate limits contained therein solely by the payment for damages for accidents or occurrences, whichever is applicable, that take place during each annual period of this policy and that are insured by this policy.

If you fail to comply with this requirement, we will only be liable to the same extent that we would had you fully complied with this requirement.

II. Definitions

A. Ultimate Net Loss

The term "Ultimate Net Loss" means the amount payable in settlement of the liability of the Insured after making deductions for all recoveries and for other valid and collectible insurance, excepting however the Underlying Insurance shown in Item 4 of the Declarations.

B. Each Annual Period

The term "Each Annual Period" means each consecutive period of one year commencing from the inception date of this policy.

C. Pollutants

The term "Pollutants" means any solid, liquid, gaseous or thermal irritant or contaminant, including smoke, vapor, soot, fumes, acids, alkalis, chemicals and waste material. Waste material includes materials which are intended to be or have been recycled, reconditioned or reclaimed.

Underlying Limits:

<u>Type of Policy or Coverage</u>	<u>Insurer, Policy No. and Policy Limits Period</u>	<u>Limits</u>
GENERAL LIABILITY (APPLICABLE TO NON-D.O.T. PROJECTS)	Arch Specialty Insurance Compa GPP0022658-07 08/01/15 08/01/16	\$1,000,000 EACH OCCURRENCE \$2,000,000 GENERAL AGGREGATE \$2,000,000 PER PROJECT AGGREGATE \$2,000,000 PRODUCTS/C. OPS. AGGREGATE
		Defense Expenses are in addition to the limit
GENERAL LIABILITY (APPLICABLE TO D.O.T. PROJECTS)	Arch Specialty Insurance Compa GPP0027028-07 08/01/15 08/01/16	\$2,000,000 EACH OCCURRENCE \$4,000,000 GENERAL AGGREGATE \$2,000,000 PER PROJECT AGGREGATE \$2,000,000 PRODUCTS/C. OPS. AGGREGATE
		Defense Expenses are in addition to the limit
AUTO LIABILITY	Zurich American Insurance Comp BAP5571088-03 08/01/15 08/01/16	\$2,000,000 COMBINED SINGLE LIMIT
		Defense Expenses are in addition to the limit
EMPLOYERS LIABILITY	Zurich American Insurance Comp WC 5932057-02 08/01/15 08/01/16	\$1,000,000 EACH ACCIDENT \$1,000,000 DISEASE EACH EMPLOYEE \$1,000,000 DISEASE POLICY LIMIT
		Defense Expenses are in addition to the limit

EMPLOYEE BENEFITS LIABILITY
(NON D.O.T.)

Arch Specialty Insurance Compa
GPP0022658-07
08/01/15
08/01/16

\$1,000,000
EACH OCCURRENCE
\$1,000,000
GENERAL AGGREGATE

EMPLOYEE BENEFITS LIABILITY
(D.O.T.)

Arch Specialty Insurance Compa
GPP0027028-07
08/01/15
08/01/16

Defense Expenses are in addition to the limit

\$1,000,000
EACH OCCURRENCE
\$1,000,000
GENERAL AGGREGATE

Defense Expenses are in addition to the limit



List of Approved Surplus Line Insurers (LASLI)

Please use the "Find" option in the "Edit" menu of your browser to search for a particular company.

List is current as of: April 22, 2015

[A](#) | [B - D](#) | [E - G](#) | [H - L](#) | [M - P](#) | [Q - Z](#)

A

Insurer	Date Approved
Acceptance Casualty Insurance Company (Nebraska)	10/23/2007
ACE European Group Limited (U.K.)	06/20/2007
Admiral Insurance Company (Delaware)	06/30/1995
Adriatic Insurance Company (North Dakota)	06/30/1995
AIG Specialty Insurance Company (Illinois) (Name changed from Chartis Specialty Insurance Company effective 10/01/2013)	06/30/1995
AIX Specialty Insurance Company (Delaware)	06/05/2009
Allianz Global Corporate & Specialty SE (Germany) (Name Changed from Allianz Global Corporate Specialty AG effective 11/13/2013)	06/16/2004
Allied World National Assurance Company (New Hampshire) (Name changed from Newmarket Underwriters Insurance Company effective 10/03/2007)	12/18/1997
Allied World Surplus Lines Insurance Company (Arkansas) (Name changed from Darwin Select Insurance Company effective 06/03/2014) (Name changed from ULICO Indemnity Company Effective 05/13/2010)	12/22/1995
Alterra Excess & Surplus Insurance Company (Delaware) (Name changed from Alterra Specialty Insurance Company effective 09/27/2010. Name changed from Max Specialty Insurance Company effective 05/13/2010)	06/19/2008
American Empire Surplus Lines Insurance Company (Delaware)	09/01/1995
American Western Home Insurance Company (Oklahoma)	09/01/1995
Arch Insurance Company (Europe) Limited (U.K.)	10/19/2009
Arch Specialty Insurance Company (Missouri) (Name changed from Rock River Insurance Company effective 08/01/2002) (Domicile changed from Nebraska to Missouri effective 09/30/2014)	09/01/1995
Aspen Insurance UK Limited (U.K.)	12/29/2004



- Company Profile
- Company Search
- Company Search Results
- Company Information
- Old Company Names
- Agent for Service
- Reference Information
- NAIC Group List
- Lines of Business
- Workers' Compensation
- Complaint and Request for Action/Appeals
- Contact Information
- Financial Statements PDF's
- Annual Statements
- Quarterly Statements
- Company Complaint
- Company Performance & Comparison Data
- Company Enforcement Action
- Composite Complaints Studies
- Additional Info
- Find A Company Representative In Your Area
- View Financial Disclaimer

COMPANY PROFILE

Company Information

ZURICH AMERICAN INSURANCE COMPANY
1400 AMERICAN LANE
SCHAUMBURG, IL 60196-1056
800-382-2150

Old Company Names **Effective Date**

Agent For Service

KARISSA LOWRY
 C/O CORPORATION SERVICE COMPANY
 2710 GATEWAY OAKS DRIVE, SUITE 150N
 SACRAMENTO CA 95833

Reference Information

NAIC #:	16535
California Company ID #:	4581-5
Date Authorized in California:	01/01/1999
License Status:	UNLIMITED-NORMAL
Company Type:	Property & Casualty
State of Domicile:	NEW YORK

back to top

NAIC Group List

NAIC Group #: 0212 ZURICH INS GRP

Lines Of Business

The company is authorized to transact business within these lines of insurance. For an explanation of any of these terms, please refer to the glossary.

- AIRCRAFT
- AUTOMOBILE
- BOILER AND MACHINERY
- BURGLARY
- COMMON CARRIER LIABILITY
- CREDIT
- DISABILITY
- FIRE
- LIABILITY
- MARINE
- MISCELLANEOUS
- PLATE GLASS
- SPRINKLER
- SURETY
- TEAM AND VEHICLE
- WORKERS' COMPENSATION



- Company Profile
- Company Search
- Company Search Results
- Company Information
- Old Company Names
- Agent for Service
- Reference Information
- NAIC Group List
- Lines of Business
- Workers' Compensation Complaint and Request for Action/Appeals Contact Information
- Financial Statements PDF's
- Annual Statements
- Quarterly Statements
- Company Complaint
- Company Performance & Comparison Data
- Company Enforcement Action
- Composite Complaints Studies
- Additional Info
- Find A Company Representative In Your Area
- View Financial Disclaimer

COMPANY PROFILE

Company Information

NATIONAL UNION FIRE INSURANCE COMPANY OF PITTSBURGH, PA

**180 MAIDEN LANE
NEW YORK, NY 10038
800-551-0824**

Old Company Names

Effective Date

Agent For Service

KARISSA LOWRY
C/O CORPORATION SERVICE COMPANY
2710 GATEWAY OAKS DRIVE, SUITE 150N
SACRAMENTO CA 95833

Reference Information

NAIC #:	19445
California Company ID #:	0131-3
Date Authorized in California:	11/28/1902
License Status:	UNLIMITED-NORMAL
Company Type:	Property & Casualty
State of Domicile:	PENNSYLVANIA

back to top

NAIC Group List

NAIC Group #: 0012 AMERICAN INTRNL GRP

Lines Of Business

The company is authorized to transact business within these lines of insurance. For an explanation of any of these terms, please refer to the glossary.

- AIRCRAFT
- AUTOMOBILE
- BOILER AND MACHINERY
- BURGLARY
- COMMON CARRIER LIABILITY
- DISABILITY
- FIRE
- LIABILITY
- MARINE
- MISCELLANEOUS
- PLATE GLASS
- SPRINKLER
- SURETY
- TEAM AND VEHICLE
- WORKERS' COMPENSATION