

FORM APPROVED COUNTY COUNCIL
 BY: *RS Keeler*
 DATE: 4/12/10
 TARSHAL VICTOR

606



**SUBMITTAL TO THE BOARD OF SUPERVISORS
 COUNTY OF RIVERSIDE, STATE OF CALIFORNIA**

FROM: Economic Development Agency

SUBMITTAL DATE:
 March 25, 2010

SUBJECT: RCRMC Inpatient Treatment Facility Security Cameras and Monitors – Approve Plans & Specifications

RECOMMENDED MOTION: That the Board of Supervisors:

1. Approve the plans and specifications for RCRMC Inpatient Treatment Facility Security Cameras and Monitors project and authorize the Clerk of the Board to advertise for bids; and
2. Delegate project management authority for this project to the Assistant County Executive Officer/EDA in accordance with applicable Board policies.

BACKGROUND: (Commences on page 2)

Robert Field

Robert Field
 Assistant County Executive Officer/EDA

FINANCIAL DATA	Current F.Y. Total Cost:	\$ 0	In Current Year Budget:	Yes
	Current F.Y. Net County Cost:	\$ 0	Budget Adjustment:	No
	Annual Net County Cost:	\$ 0	For Fiscal Year:	09/10

SOURCE OF FUNDS: 100 % RCRMC Operating Funds	Positions To Be Deleted Per A-30	<input type="checkbox"/>
	Requires 4/5 Vote	<input type="checkbox"/>

C.E.O. RECOMMENDATION: APPROVE

Jennifer L. Sargent

County Executive Office Signature: Jennifer L. Sargent

Dep't Recomm.:
 Per Exec. Ofc.:

Policy
 Policy
 Consent
 Consent

MINUTES OF THE BOARD OF SUPERVISORS

On motion of Supervisor Benoit, seconded by Supervisor Tavaglione and duly carried by unanimous vote, IT WAS ORDERED that the above matter is approved as recommended.

Ayes: Buster, Tavaglione, Stone, Benoit and Ashley

Nays: None

Absent: None

Date: May 4, 2010

xc: EDA, RCRMC, CIP, COB

Kecia Harper-Ihem
 Clerk of the Board

By: *Kecia Harper-Ihem*
 Deputy

Prev. Agn. Ref.: 3.41 of 7/21/09; 3.51 of 07/31/07

District: 1

Agenda Number:

ATTACHMENTS FILED
 WITH THE CLERK OF THE BOARD

3.24

BACKGROUND:

On July 31, 2007, the Board of Supervisors approved a pre-qualified list of consultants to be retained on an as-needed basis.

On July 21, 2009, The Economic Development Agency signed an agreement with P2S Engineering, Inc. for their engineering services for the RCRMC Inpatient Treatment Facility Security Cameras and Monitors project located at 9990 County Farm Road in Riverside. The bid documents are now complete and Economic Development Agency (EDA) requests approval to solicit bids for construction of this project.

All costs associated with this project will be funded through RCRMC Operating Funds. No net county cost will be incurred as a result of this agreement.

SPECIFICATIONS AND CONTRACT DOCUMENTS
FOR

**Riverside County Inpatient Mental Health treatment Facility Camera
Project
FM2008001851**



PREPARED BY
COUNTY OF RIVERSIDE
ECONOMIC DEVELOPMENT AGENCY
DESIGN & CONSTRUCTION DIVISION
April 1, 2010

FORM APPROVED COUNTY COUNSEL
BY: Marshall Victor 4/12/10
MARSHAL VICTOR DATE

MAY 04 2010 3:24 pks

TABLE OF CONTENTS

Notice Inviting Bids	1
Instructions to Bidders	2
Contractor's Proposal	4
Bid Bond	1
Agreement Form	1
Payment Bond	1
Performance Bond	1
Contractor's Certificate Regarding Workers' Compensation	1
General Conditions	44
Specifications (Set)	1

NOTICE INVITING BIDS

COUNTY OF RIVERSIDE, herein called Owner, invites sealed proposals for :

Mental Health In-patient Treatment Facility Camera Project

This Project is to install all new camera's, monitors and equipment, in wards A,B,C & D of the In-Patient Mental Health Treatment Facility, in compliance to the drawings and specifications. In strict adherence to requirements of OSHPD. At 9990 County Farm Rd, Riverside, CA.

Proposals shall be delivered to the Clerk of the Board of Supervisors, on the 1st floor of the County Administrative Center located at 4080 Lemon Street, Riverside, CA 92501 no later than _____ and will be promptly opened in public at said address.

Each Proposal shall be in accordance with the Plans, Specifications, and other Contract Documents and prepared by P2S ENGINEERING. A nonrefundable fee of (\$35.00) will be charged for each set of Plans and Specifications furnished to Contractors. An additional nonrefundable fee will be charged for each set of Plans and Specifications furnished that are requested to be mailed to Contractors. Plans and Specifications may be obtained from Mission Reprographics, 2050E. La Cadena Drive Suite L Riverside, CA 92507, 951-686-8828.

Pursuant to the Labor Code, the Governing Board of the Owner has obtained from the Director of the Department of Industrial Relations, State of California, his determination of general prevailing rates of per diem wages applicable to the work, and for holiday and overtime work, including employer payments for health and welfare, pension, vacation, and similar purposes, as set forth on the schedule which is on file at the principal office of the Owner, and which will be made available to any interested person upon request.

The Contract General Conditions for this project will contain provisions allowing successful contractor to substitute securities for monies withheld by the County to ensure performance (Public Contract Code 22300).

A Performance Bond and Payment Bond shall be required for this Project.

The Contractor will be required, per Public Contracts Code, Section 3300 and for this contract, to have a State of California contractor's license classification C-7, and or B – General Building Contractor. A **mandatory** pre-bid job walk inspection will be held on _____, meeting at the Mental Health Treatment Facility at 9990 County Farm Rd. **No bids will be accepted from bidders who have not attended the pre-bid job walk.**

For further information, contact Bruce Norris at the Economic Development Agency, Design and Construction located at 3403 10th St, Riverside, CA 92501 whose telephone number is (951) 955-03534843.

MO. _____

Advertize Riv. Press _____

INSTRUCTIONS TO BIDDERS

- A. **FORM OF PROPOSAL:** The Proposal must be made on the attached Contractor's Proposal Form which must be filled out completely, dated and signed by the bidder or duly authorized agent in accordance with the directions on the Proposal Form. Each Proposal shall include a complete list of the Subcontractors proposed for every portion of the work, in accordance with Public Contract Code, Section 4100-4114, inclusive.
- B. **SUBMISSION OF THE PROPOSAL:** Signed copies of each Proposal shall be sealed in an envelope labeled with Title of Bid and Opening Time. Proposals shall be submitted at the place designated in the Notice Inviting Bids at or before the time specified in said notice. Before that time a proposal may be withdrawn, but only in person by the bidder or someone authorized by him in writing, and not by telephone or telegram.
- C. **DRAWINGS AND SPECIFICATIONS:** All drawings specifications and Bid Documents may be obtained from Mission Reprographics and additional sets may be provided if requested by bidders and deemed necessary, for the sum of Thirty Five dollars (\$35.00) per set plus an additional fee per set for mailing if required. Plans and Specifications may be obtained from Mission Reprographics, located at 2050 E. La Cadena Dr. Suite L, Riverside, 951-686-882, Attn: Mario Silva. All fees are due at the time of request and must be paid by check or money order made payable to "Mission Reprographics".
- D. **INTERPRETATION OF THE DOCUMENTS:** Discrepancies in and omissions from the Plans, Specifications or other Contract Documents or questions as to their meaning shall, at once, be brought to the attention of the Owner. Any interpretation of the Documents will be made only by Addenda duly issued and a copy of such Addenda will be mailed or delivered to each person or firm receiving a set of such documents. The Owner will not be responsible for any other explanations or interpretations. Should anything in the scope of the work or any of the sections of the Specifications be of such nature as to be apt to cause disputes between the various trades involved, such information shall be promptly called to the attention of the Owner.
- E. **ADDENDA TO THE DOCUMENTS:** The Owner reserves the right to issue such Addenda to the documents as it may desire at any time prior to the time fixed for receiving Proposals. A copy of all such Addenda will be promptly mailed or delivered to each bidder. The number and date of each Addenda shall be listed on the Contractor's Proposal in the space provided.
- F. **OWNER'S RESERVATION OF RIGHTS:** The Owner reserves the right to reject any or all Proposals and to waive any informalities in a bid or in the bidding. No bidder may withdraw his bid for a period of sixty (60) days after the time set for the opening thereof.
- G. **BIDDER'S CHECK OR BOND:** Each Proposal must be accompanied by a certified or cashier's check or by a bid bond on the form supplied by the Owner, drawn in favor of the Owner in an amount not less than ten percent (10%) of the total Proposal. This check or bond shall be given as a guarantee that the bidder, if awarded the contract, will execute and deliver the Contract Documents and the required Payment and Performance Bonds and proof of insurance in accordance with his Proposal accepted by the Owner. In default of execution of the Contract upon award and/or delivery of said Payment and Performance Bonds, such Proposal bond or check shall be held subject to payment to the Owner of the difference in money between the amount of the bidder's Proposal and the amount for which the Owner may legally contract with another party to perform the said work, together with the costs to the Owner of redrafting, redrawing and publishing documents and papers shall, in addition, be held subject to all other actual damages suffered by the Owner, as set forth on the Contract Documents. Said check or bond will be returned upon the close of the period mentioned in Paragraph F above, and to the successful bidder upon execution of the Contract Documents. **NO BONDS WILL BE ACCEPTED UNLESS SUBMITTED ON THE FORM SUPPLIED BY OWNER.**
- H. **AWARD OF CONTRACT:** The Contract shall be awarded upon a Resolution or Minute Order to that effect duly adopted by the Governing Board of the Owner. Execution of the Contract Documents shall constitute a written memorial thereof.

- I. **ADDITIONAL INFORMATION:** The Owner reserves the right to require of a bidder, information regarding financial responsibility or such other information as the Owner determines is necessary to ascertain whether a bid is in fact the lowest responsible bid submitted, All references to an Architect shall be deemed to refer to the Owner where no Architect has been employed by the Owner.
- J. **PROMPT ACTION BY THE CONTRACTOR:** After the award of the Contract by the Governing Board and within four (4) days after the Agreement Forms are presented to the Contractor for signing, he shall return to the Owner the signed Agreements, along with all necessary Bonds and insurance.
- K. **PRE-BID CONFERENCE:** There will be a mandatory pre-bid conference for this project that will be held at the site. No bids will be accepted from bidders who have not attended the pre-bid conference.
- L. **BIDS:** Under the bidding items listed on the Contractor's Proposal, bidders shall state prices for each basis for bid given hereinafter.
1. Base Bid shall be the entire work complete in accordance with the contract documents, but not including work indicated or specified to be provided under any of the other bid items.
 2. Please note that a separate cost quotation for Contractor's Course of Construction insurance is required per General Conditions Section 2.3.6.

The basis for award will be the qualified bidder with the lowest total of the Base Bid with Course of Construction Insurance and all alternates. Alternates may be awarded in any order after determination of the lowest responsible and responsive bidder.

CONTRACTOR'S PROPOSAL

TO THE GOVERNING BOARD OF THE COUNTY OF RIVERSIDE:

Date: _____

Bidder: _____

The undersigned, having carefully examined the proposed site and the Plans and Specifications, the Notice Inviting Bids, the Instructions to Bidders, the Agreement Form, the Bond Forms, the General Conditions for the Construction of Third Street and Park Avenue Parking lot, hereby proposes and agrees to furnish all tools, equipment, services, apparatus, facilities, transportation, labor and materials necessary to complete the work in strict conformity with the Plans and Specifications, including all work specified in Addenda numbered and dated:

Addendum No. _____ Date _____

Addendum No. _____ Date _____

Addendum No. _____ Date _____

For the total Base Bid _____ dollars (\$ _____), including all applicable taxes, permits, licenses, **AND Course of Construction Insurance.**

(Add or Deduct state which)

Alternate 1 \$ _____

Alternate 2 \$ _____

Alternate 3 \$ _____

Alternate 4 \$ _____

And,
Cost of Contractor's Course of Construction Insurance _____ dollars (\$ _____)
and deductible \$ _____.

Bids must be submitted on all items. Failure to bid on all items may result in the bid being rejected as non-responsive. The basis for award will be the qualified bidder with the lowest total of the Base Bid WITH COURSE OF CONSTRUCTION INSURANCE and all alternates. Alternates may be awarded in any order after determination of the lowest responsible and responsive bidder.

AWARD OF CONTRACT

The undersigned fully understands that a Contract is formed upon the acceptance of this Proposal by the Owner and the undersigned further agrees that upon request he will promptly execute and deliver to Owner a written memorial of the Contract together with the required Payment and Performance Bonds and proof of insurance.

BID GUARANTEE

The enclosed certified or cashier's check or bidder's bond on approved form, made payable to the Owner in the amount of ten percent of the total bid submitted herewith, is hereby given as a guarantee that the bidder will execute and deliver the above mentioned written memorial and required bonds and insurance if awarded the contract, and in the event that the undersigned fails or refuses to execute and deliver said documents, such check or bond is to be charged with the costs of the damages experienced by the Owner as a result of such failure or refusal, including but not limited to publication costs, the difference in money between the amount of the bid of the said principal and the amount for which obligee may legally contract with another party to perform the said work if such amount be in excess of the former, building lease or rental costs, transportation costs and additional salary costs that result from the delay due to the principal's default on the awarded contract. In no event, however, shall the Surety's liability exceed the penal sum hereof.

Name of Bidder: _____

Type of Organization: _____

Signed By: _____

Title of Signer: _____

Address of Bidder: _____

Telephone No.: _____

Contractor's License No.: _____

Classification: _____ Expiration Date: _____

Affix Seal
If
Corporation

LICENSURE STATEMENTS ARE MADE UNDER PENALTY OF PERJURY

If bidder is a corporation, and signer is not President or Secretary, attach a certified copy of By-Laws or resolution authorizing execution. If bidder is a corporation, affix corporate seal. If signer is an agent, attach Power of Attorney. If bidder is not an individual, list names of other persons authorized to bind the organization.

**NONCOLLUSION AFFIDAVIT TO BE EXECUTED BY BIDDER AND
SUBMITTED WITH BID**

State of California) ss.
County of Riverside)

_____, being first duly sworn, deposes and says:

That he or she is _____ of _____
the party making the foregoing bid; that the bid is not made in the interest of, or on behalf of, any undisclosed person, partnership, company, association, organization, or corporation; that the bid is genuine and not collusive or sham; that the bidder has not directly or indirectly induced or solicited any other bidder to put in a false or sham bid, and has not directly or indirectly colluded, conspired, connived, or agreed with any bidder or anyone else to put in a sham bid, or that anyone shall refrain from bidding; that the bidder has not in any manner, directly or indirectly, sought by agreement, communication, or conference with anyone to fix the bid price of the bidder or any other bidder, or to fix any overhead, profit, or cost element of the bid price, or of that of any other bidder, or to secure any advantage against the public body awarding the contract of anyone interested in the proposed contract; that all statements contained in the bid are true; and, further, that the bidder has not, directly or indirectly, submitted his or her bid price or any breakdown thereof, or the contents thereof, or divulged information or data relative thereto, or paid, and will not pay, any fee to any corporation, partnership, company association, organization, bid depository, or to any member or agent thereof to effectuate a collusive or sham bid.

Signature

Subscribed and sworn to before me this _____ day of _____, 2009

Signature of officer administering oath

Bid Bond

KNOWN TO ALL MEN BY THESE PRESENTS, that we, the undersigned _____, as Principal; and _____, as Surety, are hereby held and firmly bound unto the County of Riverside, hereinafter called the "Owner", in the sum of _____ Dollars (\$ _____) for the payment of such sum, well and truly to be made, do hereby jointly and severally bind ourselves, our heirs, executors, administrators, successors and assigns.

WHEREAS, the said Principal is herewith submitting its Proposal for the _____

THE CONDITION OF THE ABOVE OBLIGATION IS SUCH, that if the aforesaid Principal shall be awarded the Contract upon said Proposal and shall, within the required number of days after the notice of such award, execute a written memorial of the awarded Contract and submit the required Labor and Material Payment and faithful Performance Bond and proof of insurance, then this obligation shall be null and void; and in the event that the Principal fails and/or refuses to execute and deliver said documents this Bond will be charged with the costs of the damages experienced by the Owner as a result of such refusal, including but not limited to, publication cost, the difference in money between the amount of the bid of the said Principal and the amount for which the obligee may legally contract with another party to perform the said work if such amount be in excess of the former; building lease or rental costs, transportation cost, and additional salary costs that result from the delay due to the Principal's default on the awarded Contract. In no event however, shall the Surety's liability exceed the penal sum hereof.

The Surety, for value received, hereby stipulates and agrees that the obligations of said Surety and its bond shall be in no way impaired or affected by any extension of the time within which the Owner may accept such bid; and said Surety does hereby waive notice of any such extension.

IN WITNESS WHEREOF, the above bounded parties have executed this instrument under their separate seals this _____ day of _____, 2009, the name and corporate seal of each corporate party being hereto affixed and those present duly signed by its undersigned representative, pursuant to authority of its governing body.

(Firm Name - Principal)

(Business Address)

By _____
(Original Signature)

(Title)

(Corporation Name - Surety)

(Business Address)

By _____
(Original Signature)

Affix Seal
If
Corporation

Affix
Corporate
Seal

AGREEMENT FORM

THIS AGREEMENT, entered into this _____ day of _____, 2010, by and between ___Roadway Engineering & Contracting Inc., hereinafter called the "Contractor", and the County of Riverside hereinafter called the "Owner".

WITNESSETH: That the parties hereto have mutually covenanted and agreed as follows:

CONTRACT: The Complete Contract includes all of the Contract Documents, to wit: The Notice Inviting Bids, the Instructions to Bidders, the Contractor's Proposal, Wage Schedule, Payment and Performance Bonds, the Plans and Specifications plus any Addenda thereto, the General Conditions, the Supplementary General Conditions, if applicable and this Agreement. All Contract Documents are intended to cooperate and be complimentary so that any work called for in one and not mentioned in the other, or vice versa, is to be executed the same as if mentioned in all Contract Documents.

STATEMENT OF WORK: The Contractor hereby agrees to furnish all tools, equipment, services, apparatus, facilities, transportation, labor and materials for the County Farm Inpatient Treatment Facility, In strict accordance with the Plans and Specifications dated March 2010 prepared by P2S Engineering herein after called the "Architect", including addenda thereto as listed in the Contractor's Proposal, all of which are made a part hereof.

TIME FOR COMPLETION: The work shall be commenced on a date to be specified in a written order of the Architect and shall be completed within sixty (90) calendar days from and after said date. It is expressly agreed that except for extensions of time duly granted in the manner and for the reasons specified in the General Conditions, time shall be of the essence.

COMPENSATION TO BE PAID TO CONTRACTOR: The Owner agrees to pay and the Contractor agrees to accept in full consideration for the performance of the Contract, subject to additions and deductions as provided in the General Conditions, the sum of _____. The sum is to be paid according to the schedule as provided in the General Conditions.

Pursuant to Labor Code, Section 1861, the Contractor gives the following certification: I am aware of the provisions of Section 3700 of the Labor Code which require every employer to be insured against liability for Worker's Compensation or to undertake self-insurance in accordance with the provisions of that code, and I will comply with such provisions before commencing the performance of the work of this Contract.

IN WITNESS WHEREOF, the parties hereto on the day and year first above written have executed this agreement in four (4) counterparts.

Type of Contractor's organization: _____ "B"

If other than individual or corporation, list names of all members who have authority to bind firm.

Firm Name: _____

Address: _____

Contractor's License No.: _____

IF OTHER THAN CORPORATION EXECUTE HERE

Signature: _____

Title: _____

IF CORPORATION, FILL OUT FOLLOWING AND EXECUTE

Name of President of Corporation: _____

Name of Secretary of Corporation: _____

Corporation is organized under the laws of State of _____

Signature: _____

Title: _____

Owner: COUNTY OF RIVERSIDE

Signature: _____

Title: Chairman - Board of Supervisors

Attest: Clerk - Board of Supervisors

By: _____

Title: _____

Affix Seal
If
Corporation

PAYMENT BOND

(Public Work - Civil Code Section 3247 et seq.)

The makers of this Bond are _____ as Principal and Original Contractor and _____, a corporation, authorized to issue Surety Bonds in California, as Surety, and this Bond is issued in conjunction with that certain public works contract dated _____, 2010. between Principal and County of Riverside, a public entity, as owner, for _____ dollars (\$ _____) the total amount payable. THE AMOUNT OF THIS BOND IS 100% OF SAID SUM. Said contract is for public work of: _____

The beneficiaries of this Bond are as is stated in 3248 of the Civil Code and the requirements and conditions of this Bond are as is set forth in Sections 3248, 3249, 3250 and 3252 of said Code. Without notice, Surety consents to extension of time for performance, change in requirements, amount of compensation, or prepayment under said Contract.

Signed and Sealed this _____ Day of _____ 2010.

(Firm Name - Principal)

(Business Address)

Affix Seal
if
Corporation

By: _____
(Signature - Attach Notary's Acknowledgment)

(Title)

(Corporation Name - Surety)

(Business Address)

Affix
Corporate
Seal

By: _____
(Signature - Attached Notary's Acknowledgment)

ATTORNEY-IN-FACT
(Title-Attach Power of Attorney)

PERFORMANCE BOND

The makers of this Bond, _____, as Principal, and _____ as Surety, are held and firmly bound unto County of Riverside, hereinafter called the Owner, in the sum of _____ Dollars (\$ _____) for the payment of which sum well and truly to be made, we bind ourselves, our heirs, executors, administrators, and successors, jointly and severally, firmly by these presents.

The condition of this obligation is such, that whereas the Principal entered into a certain contract, hereto attached, with the Owner, dated _____, 2010 for _____

Now therefore, if the Principal shall well and truly perform and fulfill all the undertakings covenants, terms, conditions and agreements of said Contract during the original term of said Contract and any extension thereof that may be granted by the Owner, with or without notice to the Surety, and during the file of any guarantee required under the Contract, and shall also well and truly perform and fulfill all the undertakings, covenants, terms, conditions, and agreements of any and all duly authorized modifications of said Contract that may thereafter be made, then this obligation to be void, otherwise to remain in full force and virtue. Without notice, Surety consents to extension of time for performance, change in requirements, change in compensation or prepayment under said Contract.

Signed and Sealed this _____ Day of _____, 2010

(Firm Name - Principal)

(Business Address)

Affix Seal
if
Corporation

By: _____
(Signature - Attach Notary's Acknowledgment)

(Title)

(Corporation Name - Surety)

(Business Address)

Affix
Corporate
Seal

By: _____
(Signature - Attach Notary's Acknowledgment)

ATTORNEY-IN-FACT
(Title-Attach Power of Attorney)

CONTRACTOR'S CERTIFICATE

REGARDING WORKERS' COMPENSATION

Labor Code Section 3700

Every employer, except the State and all political subdivisions or institutions thereof, shall secure the payment of compensation in one or more of the following ways:

- (a) By being insured against liability to pay compensation in one or more insurers duly authorized to write compensation insurance in this State.
- (b) By securing from the Director of Industrial Relations, a Certificate of Consent to Self-Insure, which may be given upon furnishing proof satisfactory to the Director of Industrial Relations of ability to self-insure and to pay any compensation that may become due to his employees

I am aware of the provisions of Section 3700 of the Labor Code which requires every employer to be insured against liability for Workers' Compensation or to undertake self-insurance in accordance with the provisions of that Code, and I will comply with such provisions before commencing the performance of this Contract.

Principal

Principal

Title

(In accordance with Article 5 [commencing at Section 1860], Chapter, Part 7, Division 2 of the Labor Code, the above Certificate must be signed and filed with the Owner prior to performing any work under this Contract.)

GENERAL CONDITIONS
TABLE OF CONTENTS

ARTICLE 1	<u>GENERAL PROVISIONS</u>	- 1 -
	1.1 - Definitions	- 1 -
	1.2 - Authorities and Limitations.....	- 3 -
	1.3 - Legal Requirements.....	- 3 -
	1.4 - Standard References.....	- 4 -
	1.5 - Permits, Licenses, Fees & Taxes.....	- 4 -
	1.6 - Separate Contracts.....	- 4 -
	1.7 - County's Authorized Representative, Inspector(s) & Architect	- 5 -
ARTICLE 2	<u>BONDS & INSURANCE</u>	- 6 -
	2.1 - Bids of \$25,000 or Less	- 6 -
	2.2 - Performance and Payment Bonds	- 6 -
	2.3 - Insurance	- 6 -
	2.4 - Indemnification	- 9 -
ARTICLE 3	<u>SITE CONDITIONS</u>	- 9 -
	3.1 - Differing Site Conditions	- 10 -
	3.2 - Site Investigation and Conditions Affecting the Work.....	- 10 -
	3.3 - Dimensions and Measurements.....	- 10 -
ARTICLE 4	<u>SPECIFICATIONS AND DRAWINGS</u>	- 10 -
	4.1 - General Provisions	- 11 -
	4.2 - Summary of the Order of Precedence.....	- 11 -
	4.3 - Clarifications/Request for Information and Additional Instructions	- 12 -
ARTICLE 5	<u>SHOP DRAWINGS AND SUBMITTALS</u>	- 13 -
	5.1 - Shop Drawings, Product Data, Coordination Drawings and Schedules.....	- 13 -
	5.2 - Samples	- 14 -
	5.3 - Substitutions	- 15 -
ARTICLE 6	<u>SCHEDULES</u>	- 15 -
	6.1 - Construction Schedule.....	- 15 -
ARTICLE 7	<u>TIME, LIQUIDATED DAMAGES AND EXTENSIONS</u>	- 16 -
	7.1 - Time of Work.....	- 16 -
	7.2 - Liquidated Damages	- 16 -
	7.3 - Unavoidable Delays	- 16 -
	7.4 - Request for Time Extension	- 17 -
ARTICLE 8	<u>PERFORMANCE</u>	- 18 -
	8.1 - Supervision & Construction Procedures.....	- 18 -
	8.2 - Supervision.....	- 18 -
	8.3 - Conduct of Work.....	- 18 -
	8.4 - Protection of Work & Property.....	- 18 -
	8.5 - Contractor's Responsibility For Work	- 19 -
	8.6 - Utilities	- 19 -
	8.7 - Working Hours.....	- 20 -

	8.8 - Material & Workmanship	- 20 -
	8.9 - Layout of Work	- 21 -
	8.10 - Use of Premises	- 21 -
	8.11 - Operations & Storage	- 21 -
	8.12 - Heat/Power/Light	- 21 -
	8.13 - Cleaning Up	- 21 -
ARTICLE 9	<u>SAFETY & HEALTH</u>	- 22 -
	9.1 - Accident Prevention	- 22 -
	9.2 - Sanitary Facilities	- 22 -
	9.3 - Responsibility for Compliance With Cal- OSHA	- 22 -
	9.4 - Toxic and Hazardous Materials and Waste	- 23 -
ARTICLE 10	<u>COUNTY-FURNISHED PROPERTY</u>	- 23 -
	10.1 - County-Furnished Property	- 23 -
ARTICLE 11	<u>BENEFICIAL OCCUPANCY</u>	- 24 -
	11.1 - Beneficial Occupancy	- 24 -
ARTICLE 12	<u>INSPECTION AND TESTING</u>	- 24 -
	12.1 - Inspection and Testing	- 24 -
	12.2 - Inspection by Other Jurisdictions	- 25 -
	12.3 - Final Inspection and Tests	- 26 -
ARTICLE 13	<u>ACCEPTANCE</u>	- 26 -
	13.1 - Acceptance of the Work	- 26 -
ARTICLE 14	<u>WARRANTY AND GUARANTEES</u>	- 26 -
	14.1 - Contractor's Warranty and Guarantee	- 26 -
ARTICLE 15	<u>ENVIRONMENTAL PROTECTION</u>	- 27 -
	15.1 - Dust Control	- 27 -
	15.2 - Excessive Noise	- 27 -
	15.3 - Pollution Control, Cleaning	- 28 -
ARTICLE 16	<u>EMPLOYMENT PRACTICES</u>	- 28 -
	16.1 - Qualifications for Employment and Apprenticeship Standards	- 28 -
	16.2 - Wages & Records	- 28 -
	16.3 - Notice of Labor Disputes	- 29 -
	16.4 - Nondiscrimination	- 30 -
ARTICLE 17	<u>SUBCONTRACTING</u>	- 31 -
	17.1 - Subcontractors	- 31 -
	17.2 - Relations of Contractor and Subcontractor	- 31 -
	17.3 - Subcontracts	- 32 -
ARTICLE 18	<u>TAXES</u>	- 32 -
	18.1 - Sales and Payroll Taxes	- 32 -
ARTICLE 19	<u>CHANGES</u>	- 32 -
	19.1 - Change Order Work	- 32 -

	19.2 - Change Orders and Labor Rates Guidelines.....	- 35 -
	19.3 – Audit.....	- 36 -
ARTICLE 20	<u>PAYMENT</u>	- 37 -
	20.1 - Payment.....	- 37 -
	20.2 - Final Payment.....	- 38 -
ARTICLE 21	<u>SUSPENSION OF WORK, TERMINATION</u>	- 39 -
	21.1 - Non-Compliance With Contract Requirements.....	- 39 -
	21.2 - Termination.....	- 40 -
ARTICLE 22	<u>DISPUTES/CLAIMS</u>	- 43 -
	22.1 - Claims.....	- 43 -
	22.2 - Claim Format/Requirements.....	- 44 -
	22.3 – Notice of Third Party Claims.....	- 44 -

GENERAL CONDITIONS OF THE CONTRACT

ARTICLE 1 **GENERAL PROVISIONS**

1.1 **DEFINITIONS**

THE CONTRACT DOCUMENTS - The Contract Documents consist of the Contract, the Performance Bond and Payment Bond and any other bond required by the Contract, the drawings, the specifications, addenda issued prior to execution of the Contract, and all modifications thereto.

THE CONTRACT - The Contract Documents form the Contract. The Contract represents the entire and integrated agreement between the parties hereto, and supersedes all prior negotiation, representations, or agreements, either written or oral, including the bidding documents.

ACT OF GOD - An Act of God is an earthquake of magnitude 4.5 or greater on the Richter scale, flood, tornado, or other cataclysmic phenomenon of nature, or rain, snowstorm, windstorm, high water, or other natural phenomenon in excess of the normal as established by National Oceanic and Atmospheric Administration weather data.

ACCEPTANCE - Acceptance is when the County determines all of the Contract requirements have been completed. Execution of the Notice of Completion will signify acceptance. A copy of the Notice of Completion will be sent to the Contractor after execution by the County. Upon receipt of the Notice of Completion, the Contractor will be relieved of the duty of protecting the work, and the County will initiate final settlement and payment.

ARCHITECT - The use of the term Architect shall mean the individual, partnership, corporation, association or joint venture contracted by the County for the design of this Work, as designated on the title sheet of these specifications and Contract Documents.

BENEFICIAL OCCUPANCY - The right of the County to occupy all or any portion of the project prior to final Acceptance of the Work. Such occupancy does not constitute acceptance or completion by the Contractor of the Work or any portion thereof, nor will it relieve the Contractor of the responsibility for correcting defective work or materials found at any time before Acceptance of the Work.

COUNTY - The term County when used herein shall mean the Board of Supervisors of the County of Riverside, a political subdivision of the State of California.

CHANGE ORDER - A Change Order is the document issued by the County authorizing any change or adjustment to the Contract Documents in accordance with Article 19 of this Contract.

CONTRACT DRAWINGS - "Contract drawings" or "drawings" means and includes (a) all drawings which have been prepared on behalf of the County and are included in the Contract Documents and all clarification drawings issued by notice to the bidders thereto; (b) all drawings submitted pursuant to the terms of the Contract by the Contractor to the County during the progress of the Work, which are accepted by the County.

CONTRACTOR'S AGENT - The representative of the Contractor, approved by the County, who shall be present at the Work and be authorized to receive and act upon instructions from the County and to execute and direct the Work on behalf of the Contractor.

CONTRACTOR - When used herein, Contractor means the prime or principal Contractor licensed to perform work in the State of California, including all joint ventures. References to subcontractor or others are only for convenience and all such references shall be considered to refer to the Contractor. The prime or principal Contractor shall be responsible for all subcontractors, and all subcontractors shall require their subcontractors to comply with the relevant provisions of the prime or principal contract.

CRITICAL PATH METHOD(CPM) - "Critical Path Method" is a schedule technique.

DAY - The use of "day" herein means calendar day and shall include every day including Saturdays, Sundays, and legal holidays.

DIRECTOR - The use of "Director" shall mean the Assistant County Executive Officer/EDA of the County or his designated representative.

INSTALL - When used herein, "install" shall mean the complete installation, in place, of any item, equipment or material.

MATERIAL - Material shall be construed to include machinery, equipment, manufactured articles, or construction such as form work, fasteners, etc., and any other classes of material to be furnished in connection with the Contract. All materials shall be new.

NOTICE OF COMPLETION - The Notice of Completion ("NOC") shall be issued at that point in the Contract when the Contractor has completed all Work required in the Contract Documents. The time for issuance shall be determined by the County through a final inspection. The NOC shall be issued by the Board of Supervisors.

NOTICE TO PROCEED - The Notice to Proceed is the written notification from the County giving the Contractor notice to commence with the Work. The Notice to Proceed will specify the start date for the Work and the completion date.

REQUEST FOR INFORMATION - (RFI) The form and procedure established for communication between the Contractor and the County to clarify or interpret the Contract Documents.

REQUEST FOR QUOTATION - (RFQ) A document consisting of supplemental details, instruction, or information issued by the Architect, through the County, for the purpose of obtaining price quotations for possible changes in the Work.

SHALL - When used herein, "shall" means anything, which is mandatory to be performed by the Contractor.

SPECIFICATIONS - The term "Specifications" means that portion of the Contract Documents consisting of the written requirements for materials, equipment, construction systems, standards and workmanship for the Work.

SUBCONTRACTOR - The term "Subcontractor" means a person or firm that has a contract with Contractor or with another subcontractor to perform a portion of the Work. Unless otherwise

specifically provided, the term Subcontractor includes Subcontractors of any tier, suppliers, manufacturers, and distributors. The term Subcontractor is referred to throughout the Contract Documents as if singular in number.

WORK - The term "Work" comprises the services and materials required by the Contract Documents, as may be amended, and includes all labor necessary to produce the construction required by the Contract Documents, and all materials and equipment incorporated or to be incorporated in such construction.

1.2 AUTHORITIES AND LIMITATIONS

- 1.2.1** The Board of Supervisors alone have the power to bind the County and to exercise the rights, responsibilities, authorities, and functions vested therein by the Contract Documents, except that they shall have the right to designate authorized representatives to act for them.
- 1.2.2** Neither the Contract, nor any part thereof, nor moneys due or to become due there under may be assigned by the Contractor without the prior written approval of the County, with the exception of the assignments to County which may be required under the terms of this Contract.

1.3 LEGAL REQUIREMENTS

- 1.3.1** Contractor shall keep informed of, and comply with, all federal, state and county laws, ordinances, rules, and regulations applicable to the Work or to those engaged or employed in the Work of this Contract, especially (but not limited to) those laws relating to hours of employment, prevailing wages, payment of wages, sanitary and safety conditions for workers, workers' compensation insurance, type and kind of materials that can be used, non-discrimination in employment and affirmative action programs. Failure to identify a specific provision in these Contract Documents shall not excuse the Contractor from complying with such applicable statutory requirements.
- 1.3.2** If conflict arises between provisions of the Contract Documents and any such laws, rules, or regulations, the Contractor shall notify the County at once in writing. If, before receiving clarification, Contractor performs any portion of the Work affected by such apparent conflict, such performance shall be at Contractor's own risk. Contractor shall not be entitled to any additional compensation or time by reason of the conflict or its later correction.
- 1.3.3** All work and materials shall be in full accordance with the latest applicable (or otherwise noted) codes, rules, and regulations including, but not limited to, the following:
- .Uniform Building Code
 - .Uniform Plumbing Code
 - .Uniform Mechanical Code
 - .Uniform Fire Code
 - .State Fire Marshal
 - .State Industrial Accident Commission's Safety Orders
 - .Rules of Local Utilities
- 1.3.4** Nothing in the specifications is to be construed to permit work not conforming to the above, and expense incurred complying with the above shall be borne by the Contractor. Whenever the specifications and working details require higher standards than those required by the ordinances, codes and statutes, the specifications and working details shall take priority over the ordinances, codes and statutes.
- 1.3.5** In submitting a bid on this public works projects, or any subcontractor agreeing to supply goods, services, or

materials, and entering a contract pursuant thereto, the contractor and/or subcontractor do offer and agree to assign the County all rights, title, and interest in and to all causes of action it may have under Section 4 of the Clayton Act (15 U.S.C. Section 15) or under the Cartwright Act (Chapter 2 (commencing with Section 16700) of Part 2 of Division 7 of the Business and Professions Code), arising from purchases of goods, services, or materials pursuant to the public works contract or the subcontract. This assignment shall be made and become effective at the time the awarding body tenders final acknowledgement by the parties.

1.4 STANDARD REFERENCES

1.4.1 All documents and publications (such as, but not limited to, manuals, handbooks, codes, standards, and specifications) which are cited in this Contract for the purpose of establishing technical (non-administrative) requirements applicable to equipment, materials, or workmanship under this Contract, shall be deemed to be incorporated herein as though fully set forth.

1.4.2 Whenever reference is made to any particular document or publication, the Contractor shall comply with the requirements set out in the edition specified in this Contract, or if not specified, the latest edition or revision thereof, in effect on the date of the solicitation of bid on this project, except as modified by, as otherwise provided in, or as limited to type, class, or grade, in the specifications of this Contract.

1.5 PERMITS, LICENSES, FEES & TAXES

1.5.1 COUNTY RESPONSIBILITIES

- a. The County will apply for all plan checks and will apply for and obtain the Building Permit(s), the Grading Permit and Construction Permits required by the County of Riverside, paying all fees in connection therewith.
- b. The County will furnish, at no expense to the Contractor, all on-site inspection of the Work and will arrange and pay for off-site inspection only as noted in the Contract Documents.

1.5.2 CONTRACTOR'S RESPONSIBILITIES

- a. The Contractor shall obtain and pay for all other permits and licenses required for the Work, including excavation permit and for plumbing, mechanical and electrical work and for operations in or over public streets or right of way under jurisdiction of public agencies other than the County.
- b. Exclusive of off-site inspection specified herein to be the County's responsibility, the Contractor shall arrange and pay for all off-site inspection of the Work, including certification, required by the specifications, drawings, or by governing authorities.
- c. Before Acceptance of the project by the County, the Contractor shall submit all licenses, permits, and certificates of inspection to the County.

1.6 SEPARATE CONTRACTS

1.6.1 The County reserves the right to perform work related to this project with its own forces, and to award separate

contracts in connection with other portions of the project or other work on the site. The Contractor shall cooperate with others in the prosecution of all work and shall not interfere with material, appliances or workmen of the County or any other contractor engaged by the County at the site of the Work. In case of disagreement regarding such use, the matter shall be referred to the County whose decision relative to said use shall govern.

1.6.2 The Contractor shall afford the County and separate contractors reasonable opportunity for the introduction and storage of their materials and equipment and the execution of their work, and shall properly connect and coordinate Contractor's Work with theirs.

1.6.3 If any part of the Contractor's Work depends for proper execution or results upon the work of the County or any separate contractor, the Contractor shall inspect and promptly report to the County any discrepancies or defects in such other work that render it unsuitable for such proper execution and results. Failure of the Contractor to so inspect and report shall constitute an acceptance of the County's or the separate contractor's work as fit and proper to receive the Work, except as to defects which may develop in the other separate contractor's work after the execution of the Contractor's Work.

1.6.4 Should the Contractor cause damage to the work or property of any separate contractor on the Project, the Contractor shall, upon due notice, settle with such other contractor by agreement, if both will so settle. If such separate contractor sues the County because of any damage alleged to have been so sustained, the Contractor agrees to indemnify and defend the County in such proceedings with the County retaining the right to select and hire independent counsel for the County paid by the Contractor.

1.6.5 Any cost caused by defective or ill-timed work shall be borne by the party responsible therefore.

1.7 COUNTY'S AUTHORIZED REPRESENTATIVE, INSPECTOR(S), & ARCHITECT

1.7.1 AUTHORIZED REPRESENTATIVE

The County shall designate a representative during the Work, who shall have the right to be present at the job site during construction and shall supervise any additional representatives appointed by the County.

1.7.2 INSPECTOR(S)

The Inspector(s) shall have the right to observe the installation of all materials and equipment to be incorporated into the Work and the placing of such material and equipment to determine in general if the Work is proceeding in accordance with the Contract Documents. The Inspector(s) is not authorized to make changes in the Contract Documents. On the basis of his observations, he shall keep the County informed as to the progress of the Work. The Inspector shall not be responsible for means, methods, techniques, sequences, or procedures of construction nor for safety precautions and programs in connection with the Work. Nor will the inspector be responsible for the Contractor's failure to carry out the Work in accordance with the Contract Documents.

1.7.3 ARCHITECT

- a. The County has retained an Architect for this project. The Architect will advise and consult with the County, and the County will issue instructions to the Contractor. The Architect will be requested to interpret the requirements of the Contract. When requested by the County,

the Architect will, within a reasonable time, render such interpretations as he may deem necessary for the proper execution of the Work.

- b. The Architect will make periodic visits to the job site to familiarize himself generally with the progress and quality of the Work and to determine in general whether the work is proceeding in accordance with the Contract Documents. Based on such observations he will recommend approval of applications for progress payments made by Contractor. The Architect shall not be responsible for means, methods, techniques, sequences, or procedures of construction nor for safety precautions and programs in connection with the Work. Nor will the Architect be responsible for the Contractor's failure to carry out the Work in accordance with the Contract Documents.

ARTICLE 2 BONDS AND INSURANCE

2.1 BIDS OF \$25,000 OR LESS

2.1.1 If the total amount bid on the Work is \$25,000 or less, the payment bond and performance bond are not required, provided that one payment of all compensation shall be made following Acceptance of all work.

2.2 BONDS

2.2.1 GENERAL REQUIREMENTS

a. Before commencing any Work under this Contract, the Contractor shall file four of each bond with the County. These bonds shall be in the amounts and for the purposes specified below. They shall be surety bonds issued by:

- (1) Either a California Admitted Surety OR a current Treasury Listed Surety (Federal Register).

And

- (2) Either a current A.M. Best A VIII rated Surety OR an admitted surety insurer which complies with the provisions of the Code of Civil Procedure, § 995.660.

b. Should any surety or sureties upon said bonds or any of them become insufficient, Contractor shall renew said bond or bonds with good and sufficient sureties within ten (10) calendar days after receiving notice from the County that the surety or sureties are insufficient. Cost of bonds shall be included in the bid price.

2.2.2 PERFORMANCE BOND

The successful bidder shall deliver to the County an executed Performance Bond on the attached form in an amount equal to 100% of the accepted bid as security for the faithful performance of the Contract.

2.2.3 PAYMENT BOND

The successful bidder shall deliver to the County an executed Payment Bond on the attached form in an amount equal to 100% of the accepted bid as security for the payment of all persons performing labor and furnishing materials in connection with the Work.

2.3 INSURANCE

2.3.1 GENERAL REQUIREMENTS

Before commencing this Work under the Contract, and without limiting or diminishing CONTRACTOR'S obligation to indemnify and hold the COUNTY harmless, the Contractor shall procure and maintain, or cause to be maintained at its sole cost and expense, the following insurance coverages during the term of this Contract.

2.3.2 WORKERS' COMPENSATION INSURANCE

Contractor shall secure Workers' Compensation Insurance (Coverage A) as prescribed by the laws of the State of California. Policy shall include Employers' Liability (Coverage B) including Occupational Disease with limits not less than \$1,000,000 per person per accident. Policy shall be endorsed, if applicable, to provide a Borrowed Servant/Alternate Employer Endorsement, and contain a Waiver of Subrogation in favor of the County of *Riverside* Pursuant to Section 3700 of the Labor Code of the State of California, Contractor shall file with the County before commencing the Work the following signed certification:

"I am aware of the provisions of Section 3700 of the Labor Code, which requires every employer to be insured against liability for workers' compensation or to undertake self-insurance in accordance with the provisions of that Code, and I shall comply with such provisions before commencing the performance of the Work of this Contract."

2.3.3 COMMERCIAL GENERAL LIABILITY:

Commercial General Liability insurance coverage, including but not limited to, premises liability, contractual liability, products/completed operations if applicable, personal and advertising injury – which may arise from or out of CONTRACTOR'S operations, use, and management of the premises, or the performance of its obligations hereunder. Policy shall name the County of Riverside—it's Director's, Officers, special Districts, Board of Supervisors, employees, agents or representatives as Additional Insured, and contain a Waiver of Subrogation in favor of the County of Riverside. Policy limits shall not be less than \$1,000,000 per occurrence combined single limits. If such insurance contains a general aggregate limit, it shall apply separately to this agreement or be no less than two (2) times the occurrence limit. Policy shall also contain coverage for \$5,000 Medical Payments coverage per accident, per person, and Fire Legal Liability in an amount not less than \$50,000.

2.3.4 VEHICLE LIABILITY:

If CONTRACTOR'S vehicles or licensed mobile equipment are used on County property, or used in any manner on behalf of the County, CONTRACTOR shall maintain auto liability insurance for all owned, non-owned and hired automobiles in an amount not less than \$1,000,000 per occurrence combined single limit, \$2,000,000 in the aggregate. Policy shall name the County of Riverside, its Director's Officers, Special Districts, Board of Supervisors, employees, agents, or representatives as Additional Insured, and provide a Waiver of Subrogation in favor of the County of Riverside.

2.3.5 PROPERTY (PHYSICAL DAMAGE):

All-Risk property insurance coverage for the full replacement value of all CONTRACTOR'S equipment, improvements/alterations, temporary structures, and systems (Care, Custody, and Control of CONTRACTOR) used on COUNTY property, or used in any way connected with the accomplishment of the Work performed in this contract.

2.3.6 COURSE OF CONSTRUCTION INSURANCE

CONTRACTOR shall provide All Risk Builder's Risk (Course of Construction) insurance, including earthquake and flood if in an earthquake or flood zone (required on financed or bond financing arrangements), covering the COUNTY, the CONTRACTOR and every subcontractor of every tier for the entire project including property to be used in the construction of the project while such property is at off site storage locations or while in transit. Policy shall include coverage for collapse, faulty workmanship, debris removal, expediting expense, Fire Department Service charges, valuable papers and records, trees, grass, shrubbery and plants. If scaffolding, falsework and temporary buildings are insured separately by the CONTRACTOR or others, evidence of such separate coverage shall be provided to COUNTY prior to the start of the work. Policy shall be written on a completed value form. Policy shall also provide coverage for temporary structures (onsite offices, etc.), fixtures, machinery and equipment being installed as part of the construction project. (The Base Bid including course of construction insurance shall be used for determination of lowest bid, unless otherwise stated in the bid form.)

CONTRACTOR shall provide a bid price with Course of Construction insurance as outlined herein, and shall also separately provide the cost of the Course of Construction insurance and deductible; and shall declare all terms, conditions, coverages and limits upon request of COUNTY. COUNTY RETAINS THE RIGHT TO CHOOSE TO USE ITS OWN COURSE OF CONSTRUCTION PROGRAM. If the COUNTY program is chosen, CONTRACTOR shall assume the cost of any and all applicable policy deductibles (currently \$50,000 per occurrence), and shall insure its own machinery, equipment, tools, etc., from any loss of any nature whatever. If COUNTY elects the CONTRACTOR's All Risk Builder's Risk Program, CONTRACTOR shall be responsible for any and all policy deductibles.

2.3.7 GENERAL INSURANCE PROVISION – ALL LINES:

- a. Any insurance carrier providing insurance coverage hereunder shall be admitted to the State of California unless waived, in writing, by the County Risk Manager. Carrier(s) shall have an A.M. BEST rating of not less than an A:VIII. Insurance deductibles or self-insured retentions must be declared by the carrier(s), and such deductibles and retentions shall have the prior written consent from the County Risk Manager. At the election of the Risk Manager, carriers shall provide written notification, and shall either 1) reduce or eliminate such deductibles or self-insured retentions, or 2) procure a bond which guarantees payment of losses and related investigations, claims administration, and defense costs and expenses. If no written notice is received from the County Risk Manager within ten (10) days of the acceptance of agreement, then such deductibles or self-insured retentions shall be deemed acceptable.

- b. Cause its insurance carrier(s) to furnish the County of Riverside with either 1) a properly executed original Certificate(s) of Insurance and certified original copies of Endorsements effecting coverage as required herein, or 2) if requested to do so in writing by the County Risk Manager, provide original Certified copies of policies including all Endorsements and all attachments thereto, showing such insurance is in full force and effect. The County of Riverside, its Director's and Officers, Special Districts, Board of Supervisors, elected officials, employees, agents or representatives are named as Additional Insureds. Further, said Certificate(s) and policies of insurance shall contain the covenant of the insurance carrier(s) that shall provide no less than thirty (30) days written notice be given to the County of Riverside prior to any material modification or cancellation of such insurance. In the event of a material modification or cancellation of coverage, this Agreement shall terminate forthwith, unless the County of Riverside receives, prior to such effective date, another properly executed original Certificate of Insurance and original copies of endorsements or certified original policies, including all endorsements and attachments thereto evidencing coverages set forth herein and the

insurance required herein is in full force and effect. **CONTRACTOR shall not take possession, or use the Premises, or commence operations under this Agreement until the County of Riverside has been furnished original Certificate(s) of Insurance and certified original copies of Endorsements or policies of insurance including all Endorsements and any and all other attachments as required in this Section. The original Endorsements for each policy and the Certificate of Insurance shall be signed by an individual authorized by the insurance carrier to do so on its behalf.**

- c. It is understood and agreed to by the parties hereto and the insurance company(s), that the Certificate(s) of Insurance and policies shall so covenant and shall be construed as primary, and the COUNTY'S insurance and/or deductibles and/or self-insured retentions or self-insured programs shall not be construed as contributory.

The County of Riverside's Reserved Rights-Insurance. The County of Riverside reserves the right to adjust the monetary limits of insurance coverage's during the term of this agreement or any extension thereof-if in the County Risk Manager's reasonable judgment, the amount or type of insurance carried by the CONTRACTOR becomes inadequate.

- d. CONTRACTOR shall pass down the insurance obligations contained herein to all tiers of sub-consultants working under this Agreement.

2.4 INDEMNITY AND HOLD HARMLESS

2.4.1 CONTRACTOR agrees to and shall indemnify and hold the COUNTY-its officers, employees and agents free and harmless from any and all claims, actions, damages and liabilities of whatsoever kind and nature arising from death, personal injury, property damage or other cause asserted or, based upon any negligent act or omission of CONTRACTOR, its employees, agents, invitees, or any subcontractor of CONTRACTOR relating to or in any way connected with the accomplishment of the work or performance of services under this Agreement, regardless of the existence or degree of fault or negligence on the part of the COUNTY or any officer or employee of said COUNTY, other than the sole active negligence or willful misconduct of COUNTY-its Directors and Officers, Special Districts, Board of Supervisors, elected officials, employees, agents or representatives. As part hereto of the foregoing indemnity CONTRACTOR agrees to protect and defend at its own expense, including attorneys' fees the COUNTY-its Directors and Officers, Special Districts, Board of Supervisors, elected officials, employees, agents or representatives from any and all legal action based upon any acts or omissions, as stated hereinabove, by any person or persons.

2.4.2 If any such claim, action, or proceeding is brought against County or County's officers, agents, employees, or independent contractors, Contractor, upon notice from County, shall defend the same at Contractor's expense by counsel satisfactory to County.

2.4.3 County shall promptly notify Contractor of any claim, action, or proceeding against County or County's officers, agents employees, independent contractors, and consultants relating to the performance, or omission to perform, any term or condition of this Contract. County shall cooperate fully in the defense of such claim, action, or proceeding.

2.4.4 County shall not be liable or responsible for any accident, loss or damage occurring to the Work prior to the completion and Acceptance of same, unless otherwise specifically agreed to at the time of occupancy by the County.

ARTICLE 3 SITE CONDITIONS

3.1 DIFFERING SITE CONDITIONS

- 3.1.1** The Contractor shall have reviewed and ascertained pertinent local conditions such as location, accessibility, and general character of the site and satisfy himself as to the conditions under which the Work is to be performed. No claim for allowances shall be made because of Contractor's error or negligence in acquainting himself with the conditions at the site.
- 3.1.2** The Contractor shall carefully study and compare the Contract Documents with each other and with information furnished by County. The Contractor shall promptly report in writing to County any errors, inconsistencies, or omissions in the Contract Documents or inconsistencies with applicable code requirements observed by Contractor.
- 3.1.3** If Contractor performs any construction activity which it knows or should know involves an error, inconsistency, or omission without notifying and obtaining the written consent of County, Contractor shall be responsible for the resultant losses, including, without limitation, the costs of correcting defective work.
- 3.1.4** The County will furnish surveys necessary to properly locate the property and establish the boundaries thereof with general reference points as well as to enable the Contractor to proceed with the Work.
- 3.1.5** The Contractor shall provide competent engineering services to lay out the Work and all parts thereof and to establish all grades and elevations in accordance with the Contract requirements. He shall verify the figures shown on the survey and approach drawings before undertaking any construction work and shall be responsible for the accuracy of the finished work.
- 3.1.6** The Contractor shall protect and preserve established bench marks and monuments and shall make no changes in locations without the written approval of the County. Any bench marks or monuments that are lost or destroyed shall be replaced by the Contractor subsequent to notification and approval from County.

3.2 SITE INVESTIGATION AND CONDITIONS AFFECTING THE WORK

- 3.2.1** The Contractor acknowledges by submission of his/her bid that he has satisfied himself as to the character, quality, and quantity of surface and subsurface materials or obstacles to be encountered insofar as this information is reasonably ascertainable from an inspection of the site, including any exploratory work deemed necessary by the Contractor. Any failure of the Contractor to take the actions described and acknowledged in this paragraph will not relieve the Contractor from responsibility for estimating the difficulty and cost of successfully performing the Work, or for proceeding to successfully perform the Work without additional expense to the County.

3.3 DIMENSIONS AND MEASUREMENTS

- 3.3.1** All dimensions shown for existing conditions and all dimensions required for work that is to connect with work now in place, shall be verified and calculated by the Contractor by actual measurement of the existing work. Any discrepancies between the Contract Documents and the existing conditions shall be referred to the authorized representative of the County before any work affected thereby has been performed. Failure to notify the County before starting work will be considered acceptance by the Contractor. Where doubts as to dimensions exist, County shall determine the correct dimensions.

ARTICLE 4 SPECIFICATIONS AND DRAWINGS

4.1 GENERAL PROVISIONS

4.1.1 SUBDIVISIONS

For convenience, the specifications are arranged into several sections, but such separation shall not be considered as the limits of the work required of any separate trade. The terms and conditions of such limitations are wholly between the Contractor and his subcontractors. Requirements contained in any section are required as if contained in all sections and are the responsibility of the Contractor. The Contractor, prior to awarding subcontracts, will assure the Work required as a whole has been coordinated among the subcontracts.

4.1.2 RECORD DOCUMENTS

- a. The Contractor shall keep on the Work site a copy of the awarded construction documents (drawings and specifications) and shall at all times give the County and Architect access thereto.
- b. The Contractor will be given one set of drawings and specifications which shall be kept at the site of the Work at all times and updated weekly. Payment may be withheld if drawings are not kept current. Exact locations of all pipes and conduits and all changes in construction and details shall be indicated and dimensions provided upon these drawings, and all changes in materials and equipment installed shall be indicated in these specifications. Upon completion and prior to Acceptance of the Work, a final reproducible (transparencies) set of project record documents and specifications shall be submitted to the County by the Contractor. County will furnish a set of reproducibles.
- c. The working details will indicate dimensions, position, and kind of construction, and the specifications, qualities, and methods. Any Work indicated on the working details and not mentioned in the specifications, or vice versa, shall be furnished as though fully set forth in both. Work not particularly detailed, marked, or specified shall be the same as similar work that is detailed, marked, or specified.
- d. In case of discrepancy in the documents, the matter shall be promptly submitted to the County, who shall make a determination in writing. Any adjustment by the Contractor without such a determination shall be at its own risk and expense. The County shall furnish from time to time such detailed information as considered necessary to clarify the Work.
- e. Where the word "similar" occurs on the drawings, it shall have a general meaning and not be interpreted as meaning identical, and all details shall be worked out in relation to their location and their connection with other parts of the work.
- f. Standard details or specification drawings are applicable when listed, bound with specifications, noted on the drawings or referenced elsewhere in the specifications. Where the notes on the drawings indicate modifications, such modifications shall govern.
- g. All drawings, specifications and copies thereof furnished to the Contractor are the property of the County and shall not be used on other work without its consent. Upon completion of this project, all copies of the drawings and specifications shall be returned to the County.

4.2 SUMMARY OF THE ORDER OF THE PROCEDURE

- 4.2.1** In case of conflicts between the Contract Documents, the order of precedence shall be as follows:

- 1) Modifications or changes last in time are first in precedence.
- 2) Addenda.
- 3) County-Contractor agreement.
- 4) General Conditions except for specific modifications thereto stated in the Supplementary Conditions.
- 5) Supplementary Conditions.
- 6) Division One Specifications.
- 7) Division Two through Sixteen Specifications.
- 8) Drawings - as between figured dimensions given on drawings and the scaled measurements, the figured dimension shall govern; as between large-scale drawings and small-scale drawings, the larger scale shall govern.
- 9) Structural drawings
- 10) Architectural drawings.
- 11) As between detailed drawings and typical details bound within the specifications, the detailed drawings govern.
- 12) In the event provisions of codes, safety orders, contract documents, referenced manufacturer's specifications or industry standards are in conflict, the more restrictive and higher quality shall govern.
- 13) Schedules shown on the drawings take precedence over conflicting information given on other drawings.
- 14) Mechanical drawings.
- 15) Electrical drawings.

4.3 CLARIFICATIONS/REQUEST FOR INFORMATION AND ADDITIONAL INSTRUCTIONS

4.3.1 NOTIFICATION BY CONTRACTOR

- a. Should Contractor discover what he perceives to be conflicts, omissions, or errors in the Contract Documents, or have any question concerning interpretation or clarification of the Contract Documents, or if it appears that the work to be done or any matters relative thereto are not sufficiently detailed or explained in the Contract Documents, then, before proceeding with the work affected, Contractor shall notify County's authorized representative in writing, and request interpretation, clarification, or additional detailed information concerning the work. The Contractor shall ask for the clarification (Request for Information) immediately upon discovery but no less than 14 calendar days prior to the start date of the activities related to the clarification, based on the latest updated version of the accepted Progress Schedule. County, whose decision shall be final and conclusive, shall resolve such questions and issue instructions to Contractor. Should Contractor proceed with work affected before receipt of instructions from County, Contractor shall remove and replace or adjust work which is not in accordance with the instructions from County and shall be responsible for resultant damage, defect or added cost. In event of failure to agree as to scope of Contract requirements, Contractor shall follow the procedure set forth in the DISPUTES article.
- b. The Contractor shall not be entitled to any compensation for delays, disruptions, inefficiencies or additional administrative effort caused by the Contractor's untimely review of the Contract Documents for potential conflicts, omissions, discrepancies or ambiguities.
- c. County may charge back to the Contractor, time and expense associated with RFI's, as may be reasonably determined by the County to be unnecessary.

4.3.2 ADDITIONAL DETAILED INSTRUCTIONS

- a. The County may furnish additional detailed written instructions on any Request for Information to further explain the Work. If in the opinion of Contractor, the additional detailed instructions constitute work in excess of the scope of the Contract, he must submit written notice thereof immediately to the County, but no later than seven (7) calendar days following receipt of such instruction(s), and in any event prior to commencement of work thereon. The Contractor shall not be entitled to additional compensation due to any additional instructions unless the Contractor shall have given the appropriate written notice. County will then consider such notice and, if in its judgment it is justified, the County instructions will be revised or extra work shall be authorized by Change Order. In the event of a dispute hereunder, attention is directed to the DISPUTES article.

ARTICLE 5 SHOP DRAWINGS AND SUBMITTALS

5.1 SHOP DRAWINGS, PRODUCT DATA, COORDINATION DRAWINGS AND SCHEDULES

- 5.1.1 Shop drawings are drawings submitted to the County by the Contractor showing detail of the proposed fabrication and assembly of structural elements and the installation (i.e., form, fit, and attachment details) of materials or equipment. It includes drawings, diagrams, layouts, schematics, descriptive literature, illustrations, schedules, fabrication, erection and setting drawings, manufacturers' scale drawings, wiring and control diagrams, cuts or entire catalogs, pamphlets, and performance and test data, and similar materials furnished by the Contractor to explain in detail specific portions of the Work required by the Contract. The County may duplicate, use, and disclose in any manner and for any purpose shop drawings delivered under this Contract.
- 5.1.2 The Contractor shall coordinate all shop drawings and review them for accuracy, completeness, and compliance with Contract requirements, and shall indicate its approval thereon as evidence of such coordination and review. Shop drawings submitted to the County without evidence of the Contractor's approval shall be returned for resubmission. The Architect will indicate review for compliance of the shop drawings, and if not in compliance as submitted, shall indicate the reasons therefore. Any work done before such review shall be at the Contractor's risk. Review by the Architect shall not relieve the Contractor from responsibility for any errors or omissions in such drawings, nor from responsibility for complying with the requirements of this Contract, except with respect to variations described and approved in accordance with paragraph 5.1.3.
- 5.1.3 If shop drawings show any variations from the Contract requirements, the Contractor shall describe such variations in writing, separate from the drawings, at the time of submission. If the Architect approves any such variation, no change in time or price will be allowed for Contractor changes. Should the Architect make changes on the shop drawings which affect time and/or cost, the Contractor will immediately notify the County with a Request for Information. If the Contractor fails to issue the Request for Information within seven (7) calendar days from receipt of the returned shop drawing, the Contractor shall have waived his right to any potential Change Order.
- 5.1.4 The Contractor shall submit shop drawings, coordination drawings, and schedules for review as required by the Contract Documents. The Contractor will provide a submittal schedule listing all shop drawings and submittals, the submission dates by the Contractor, and return dates from the Architect. This schedule will be provided fourteen (14) calendar days after the Notice to Proceed.
- 5.1.5 Shop drawings and schedules, other than catalogs, pamphlets, and similar printed material, shall be submitted with one reproducible plus one copy.
- 5.1.6 Each shop drawing or coordination drawing shall have a blank area 4 by 4 inches located adjacent to the title block. The title block shall display the following:

- 1) Number and title of drawing
- 2) Date of drawing or revision
- 3) Name of project building or facility
- 4) Name of Contractor and (if appropriate) name of subcontractor submitting drawings
- 5) Clear identity of contents and location on the work
- 6) Project title and project number
- 7) Submittal number

5.1.7 Unless otherwise provided in this Contract or otherwise directed by County, shop drawings, coordination drawings, and schedules shall be submitted to the Architect with a letter, sufficiently in advance of construction requirements to permit no less than twenty (21) calendar days for checking and appropriate action.

5.2 SAMPLES

5.2.1 After the award of the Contract, the Contractor shall deliver samples required by the specifications to the County for approval. The Contractor shall prepay any shipping charges. Any materials or equipment for which samples are required shall not be used in the Work until reviewed by County.

5.2.2 Each sample shall have a label indicating:

- 1) Name of project building or facility, project title, and project number.
- 2) Name of Contractor and, if appropriate, name of subcontractor.
- 3) Identification of material or equipment with specification requirement.
- 4) Place of origin.
- 5) Name of manufacturer and brand (if any).
- 6) Identify by specification section.

5.2.3 Samples of finished materials shall have additional markings that will identify them in reference to the finish schedules.

5.2.4 The Contractor shall mail a letter in triplicate under separate cover submitting each shipment of samples and containing the information required in paragraph 5.2.2. He shall enclose a copy of this letter with the shipment and send a copy to the County representative on the project. Approval of a sample shall be only for the characteristics or use named in such review and shall not be construed to change or modify any Contract requirement. Substitutions will not be permitted unless they are approved under paragraph 5.3.

5.2.5 Approved samples not destroyed in testing will be sent to the County. Approved samples of hardware in good condition will be marked for identification and may be used in the Work. Materials and equipment incorporated in the Work shall match the approved samples. Other samples not destroyed in testing or not approved will be returned to the Contractor at his expense if so requested at time of submission.

5.2.6 Failure of any material to pass the specified tests will be sufficient cause for refusal to consider any further samples of the same brand or make of that material or equipment under this Contract.

5.2.7 Samples of various materials or equipment delivered on the site or in place, may be taken by the County for testing. Samples failing to meet Contract requirements will automatically void previous approvals of the items tested. The Contractor shall replace such materials or equipment found not to have met Contract requirements, or there shall be a proper adjustment of the Contract price as determined by the County.

5.2.8 Unless otherwise specified, when tests are required, only one test of each sample proposed for use will be made at the expense of the County. Samples which do not meet specification requirements will be rejected. Requests for testing of additional samples by Contractor may be made by the County at the expense of the

Contractor.

5.3 SUBSTITUTIONS

- 5.3.1** Wherever the name, or brand, or manufacturer of an article is specified in the Contract Documents, it is used as a measure of quality and utility or a standard. Except in those instances where the product is designated to match others presently in use, specifications calling for a designated material, product, thing or service by specific brand or trade name shall be deemed to be followed by the words "or equal" so that bidders may propose any equal material, product, thing or service in their bid. If the Contractor desires to use any other brand or manufacturer of equal quality and utility to that specified, he shall list definite particulars of that which he considers equivalent to the specified item in his bid. The Contractor shall have thirty-five (35) days after the award of the Contract for submission of data substantiating substitution of "equal" items. The County will then determine whether or not the proposed name brand or article is equal in quality and utility to that specified in the Contract Documents, and its written decision shall be final.
- 5.3.2** No proposal will be considered unless accompanied by complete information and descriptive data necessary to determine the equality of the offered materials, articles, or equipment. Samples shall be provided when requested by the County.
- 5.3.3** The burden of proof as to the comparative quality or suitability of the offered materials, articles, or equipment shall be upon the Contractor. The County shall be the sole judge as to such matters. In the event that the County rejects the use of such alternative materials, articles, or equipment, then one of the particular products designated by brand name in the specifications shall be furnished.
- 5.3.4** The County will examine Contractor's submittals with reasonable promptness. Return of the submittals to the Contractor shall not relieve the Contractor from responsibility for deviations and alternatives from the Contract Documents nor shall it relieve him from responsibility for errors in the submittals. A failure by the Contractor to identify, in his letter of transmittal, material deviations from the Contract Documents shall void the submittal and any action taken thereon by the County. When specifically requested by the County, the Contractor shall resubmit such shop drawing(s), descriptive data, and samples as may be required.
- 5.3.5** If any mechanical, electrical, structural, or design revisions are required for the proper installation and fit of alternative materials, articles, or equipment, or because of deviations from the Contract Documents, such changes shall not be made without the consent of the County's authorized representative, and shall be made without additional cost to the County, such costs, including the fees of the Architect, to be borne by the Contractor.

ARTICLE 6 SCHEDULES

6.1 CONSTRUCTION SCHEDULE

- 6.1.1** The Contractor shall prepare and submit to the County a practicable schedule showing the order in which the Contractor proposes to perform the work, and the dates on which the Contractor contemplates starting and completing the salient features of the work (including acquiring materials and equipment). The schedule shall be in the form of a CPM (critical path method) schedule, of suitable scale to indicate appropriately the percentage of work scheduled for completion by any given date during the period. The scheduled completion date shall be the same as the contractual completion date, for the initial schedule and subsequent updates. Any proposed early completion date shall show the difference between that date and the contract completion date as Float, which shall belong to both the County and Contractor.

- 6.1.2** If, in the opinion of the County, the Contractor falls behind the approved schedule, the Contractor shall take steps necessary to improve its progress, without additional cost to the County. The Contractor shall submit any supplementary schedule or schedules in CPM form as the County deems necessary to demonstrate how the approved rate of progress will be regained.
- 6.1.3** All schedule updates must accurately reflect the as-built schedule. There shall be no change to the Critical Path without the County's written consent.

ARTICLE 7 **TIME, LIQUIDATED DAMAGES AND EXTENSIONS**

7.1 **TIME OF WORK**

The Contractor shall commence work on this project immediately upon receipt of the written Notice to Proceed and shall perform the work diligently to completion within the number of calendar days specified in the Contract. Neither site access nor physical work shall be commenced before the Contract is fully executed, and bonds, insurance and the schedule are submitted as required by the Contract Documents. No work shall be done on Saturday, Sunday and holidays and no work shall be performed outside of normal working hours without the prior written consent of the County, unless required by these Specifications. See: Working Hours.

7.2 **LIQUIDATED DAMAGES**

If the Work is not completed within the time required, damage will be sustained by the County. It is and will be impracticable and extremely difficult to ascertain and determine actual damage which County will sustain by reason of such delay; and it is therefore agreed that Contractor will pay to County the sum of **\$insert amount** per day for each and every day's delay in finishing the Work beyond the time prescribed. If the Contractor fails to pay such liquidated damages, the County may deduct the amount thereof from any money due or that may become due the Contractor under the Contract.

7.3 **UNAVOIDABLE DELAYS**

7.3.1 **TIME EXTENSION**

- a. The Contractor will be granted an extension of time for completion of the Work beyond that named in the Contract Documents, for delays which may result through causes beyond the control of the Contractor and which he could not have avoided by the exercise of care, prudence, foresight and diligence. The appropriate extension of time shall constitute full compensation. Costs associated with extended overhead will not be considered.
- b. If the Contractor is allowed extensions of time in which to complete the Work equal to the sum of all unavoidable delays, plus any adjustments of contract time due to contract change orders, during such extension of time liquidated damages shall not be charged to the Contractor.
- c. Unavoidable delays within the meaning of this section shall be those caused by Acts of God or of the public enemy, fire, epidemics, or strike. There will be no liquidated damages for delays as described within this paragraph.
- d. Delays in the performance of parts of the work which may in themselves be unavoidable, but do not necessarily prevent or delay the performance of critical activity(s) while the

activity(s) is on the Critical Path, will not be considered as unavoidable delays within the meaning of the contract and shall not be the basis of a claim for delay.

7.3.2 WEATHER

Inclement weather shall not be a prima facie reason for granting a time extension. The Contractor shall make every effort to continue work under prevailing conditions. However, if the inclement weather prevents the Contractor from beginning at the usual starting time, or prevents the Contractor from proceeding with seventy-five percent (75%) of the normal labor and equipment force towards completion of the day's current Critical Path activities (shown on the most current, and accepted schedule update) for a period of at least five (5) hours, and the crew is dismissed as a result thereof, the County will designate such time as unavoidable delay and grant a one (1) calendar day, non-compensable, time extension.

7.3.3 NOTICE OF DELAYS

- a. Whenever the Contractor foresees any delay in the performance of a Critical Path work activity, and in any event immediately upon the occurrence of any delay which he regards as an unavoidable delay, the Contractor shall notify the County in writing of such delay and its cause, in order that the County may take immediate steps to prevent, if possible, the occurrence or continuance of the delay, and may determine whether the delay is to be considered avoidable or unavoidable, how long it continues, and to what extent the prosecution and completion of the work are to be delayed thereby.
- b. After the completion of any part or the whole of the Work, the County, in calculating the amount due the Contractor, will assume that any and all delays which have occurred have been avoidable delays, except such delays as shall have been called to the attention of the County at the time of their occurrence and found by the County to have been unavoidable as substantiated by a change order. The Contractor shall make no claims that any delay not called to the attention of the County at the time of its occurrence has been an unavoidable delay.

7.4 REQUEST FOR TIME EXTENSION

7.4.1 In the event the Contractor requests an extension of contract time for unavoidable delay, justification shall be submitted no later than seven (7) calendar days after the initial occurrence of any such delay. When requesting time for proposed change orders, the request(s) must be submitted with the proposed change order with full justification. If the Contractor fails to submit justification he shall waive his right to a time extension at a later date. Justification must be based on the currently accepted contract schedule as updated at the time of occurrence of delay or execution of work related to any change(s) in the scope of work. The justification must include a schedule, including, but not limited to, the following information:

- a. The duration to perform the activity relating to the change(s) in the work and the resources (manpower, equipment, material, etc.) required to perform these activities within the stated duration.
- b. Logical activity ties to the contract schedule for the proposed changes and/or delay showing the activity/activities in the schedule whose start or completion dates are affected by the change and/or delay.

7.4.2 The County, after receipt of such justification and supporting evidence, shall make its finding of fact. The County's decision shall be final and conclusive and the County will advise the Contractor in writing of such

decision. If the County finds that the Contractor is entitled to any extension of Contract time, the County's determination as to the total number of days of extension shall be based upon the latest updated version of the approved contract schedule.

- 7.4.3 In the event the Contractor disagrees with the County's decision, the Contractor shall be required to submit a claim pursuant to the DISPUTE article.

ARTICLE 8 PERFORMANCE

8.1 SUPERVISION & CONSTRUCTION PROCEDURES

8.1.1 The Contractor shall supervise and direct the work. The Contractor shall be solely responsible for all construction means, methods, techniques, sequences, procedures, project safety, and shall coordinate all portions of the Work under the Contract, including the relations of the various trades to the progress of the Work, in accordance with the provisions of the Contract Documents.

8.1.2 The Contractor shall be responsible to the County for the acts and omissions of the Contractor's employees, subcontractors, and their agents and employees, and any other persons performing any of the work under a contract with the Contractor.

8.1.3 The Contractor is an independent contractor and nothing in the Contract Documents shall be interpreted to make the Contractor an agent of the County.

8.2 SUPERVISION

8.2.1 Within seven (7) days after the Notice to Proceed, the Contractor shall provide to the County an organization chart outlining key job personnel. The Contractor will also provide a Letter of Authority or Corporate Resolution for the individual(s) authorized to sign documents on its behalf, i.e., payment requests, change orders, inspection reports, etc.

8.2.2 The Contractor shall employ, during the progress of the Work, a competent Project Superintendent and any necessary assistants, as approved by the County. The Project Superintendent shall not be changed except with the consent of the Authorized Representative of County, unless the Superintendent proves to be unsatisfactory to the Contractor or ceases to be in his employ. The County shall be notified immediately of any new Superintendent appointed to the Work and the Contractor shall submit qualifications for approval. The Superintendent shall represent the Contractor and all directions given to him shall be as binding as if given to the Contractor.

8.2.3 The County shall be supplied at all times with the name and telephone number of a person in charge of or responsible for the Work, who can be reached for emergency work twenty-four (24) hours a day, seven (7) days a week.

8.3 CONDUCT OF WORK

8.3.1 In connecting one kind of work with another, marring or damaging same will not be permitted and, in the event such occurs, shall be corrected by the Contractor at its cost prior to acceptance by the County. Should improper work of any trade be covered by another which results in damage or defects, the whole work affected shall be made good by the Contractor without expense to County.

8.4 PROTECTION OF WORK & PROPERTY

8.4.1 The Contractor shall continuously maintain adequate protection of the Work from damage and shall protect the County's property from injury or loss in connection with this Contract. He shall make good any such damage, injury, or loss, except what may be directly due to errors in the Contract Documents or caused by agents or employees of the County. He shall adequately protect adjacent property as provided by law and the Contract Documents.

8.4.2 The Contractor shall preserve and protect all structures, equipment, and vegetation (such as trees, shrubs, and grass) on or adjacent to the Work site which are not to be removed and which do not unreasonably interfere with the work required under this Contract.

8.4.3 The Contractor shall protect from damage all existing improvements and utilities at or near the Work site and on adjacent property of a third party, the locations of which are made known to or should be known by the Contractor. The Contractor shall repair any damage to those facilities, including those that are the property of a third party, resulting from failure to comply with the requirements of this Contract or failure to exercise reasonable care in performing the Work. If the Contractor fails to repair the damage promptly, the County may have the necessary work performed and charge the cost to the Contractor.

8.5 CONTRACTOR'S RESPONSIBILITY FOR WORK

8.5.1 Until Acceptance of the Work by the County, Contractor shall have the charge and care thereof and shall bear risk of injury or damage to any part of the Work by action of the elements. If a separate Contractor sues the Owner, on account of any loss so sustained, the County shall notify the Contractor, who shall indemnify and hold harmless the County against any expenses, or judgment arising therefrom.

8.5.2 Contractor, at its cost, shall rebuild, repair, restore and make good all damages from the elements to any portion of the Work occasioned by such causes before its Acceptance.

8.5.3 No advertising of any description will be permitted in or about the Work, except by order of the County.

8.5.4 Contractor shall not create or permit the continued existence of any nuisance in or about the Work.

8.6 UTILITIES

8.6.1 Unless otherwise provided for under separate sections herein, Contractor will arrange all water, gas, and electricity required for construction purposes until acceptance of the Work. Contractor shall pay for such services unless otherwise specifically noted.

8.6.2 Utilities shall not be interrupted except with the approval of the County. A two (2) work day written notice is required prior to any and all interruptions. Interruptions shall be scheduled so as to minimize duration and disruption to existing operations.

- 8.6.3**
- a. The Contractor shall send notices, make all necessary arrangements, and perform all other services required in the care and maintenance of all public utilities.
 - b. Enclosing or boxing in, for protection of any public utility equipment, shall be done by the Contractor. Upon completion of the Work, the Contractor shall remove all enclosures, and leave in a finished condition.
 - c. All connections to public utilities shall be made and maintained in a manner so as not to

interfere with the continuing use of same by the County during the entire progress of the Work.

8.7 WORKING HOURS

- 8.7.1** All work shall be performed on a calendar day basis during the customary working hours of the trades involved unless otherwise specified in this Contract. Work performed by the Contractor of his own volition outside such established working hours shall be at no additional expense to the County and without County approval.
- 8.7.2** It is expressly stipulated that no laborer, workman, or mechanic employed at any time by the Contractor or by any subcontractor(s) under this Contract upon the Work or any part thereof, shall be required or permitted to work thereon more than eight (8) hours during any one calendar day and forty (40) hours during any one calendar week, except, as provided by Section 1815 of the California Labor Code. It is further expressly stipulated that for each and every violation of Sections 1811-1815, inclusive, of the California Labor Code, all the provisions of which are deemed to be incorporated herein, said contractor shall forfeit, as a penalty to County, twenty-five dollars (\$25.00) for each laborer, workman, or mechanic employed in the execution of this Contract by contractor for each calendar day during which said laborer, workman, or mechanic is required or permitted to work more than eight hours in any one calendar day and forty hours in any one calendar week in violation of the provisions of said Sections of the Labor Code.
- 8.7.3** The Contractor, and each subcontractor, shall keep an accurate record showing the names of and actual hours worked each calendar day and each calendar week by all laborers, workmen, and mechanics employed by them in connection with the Work contemplated by this Contract, which record shall be open at all reasonable hours to the inspection of the County or its officers or agents and to the Division of Labor Standards Enforcement of the Department of Industrial Relations.
- 8.7.4** No construction work shall be done on Saturdays, Sundays or County holidays and no work shall be performed outside of normal working hours without the prior written consent of the County. In any event, all work shall be subject to approval of the County. Prior to start of such work, the Contractor shall arrange with the County for the continuous or periodic inspection of the Work and testing of materials, when necessary. If requests are made by the Contractor for permission to work overtime, nights, Saturdays, Sundays or County holidays, and such requests are granted, the Contractor shall bear all extra expense to the County for inspection and other incidental expenses caused by such overtime work. If contractors are requested, in the interest of the County, to work overtime by the County, or if overtime work is specifically required by these specifications, all extra expense of inspection will be paid by the County.

8.8 MATERIAL & EQUIPMENT

- 8.8.1** Materials, equipment, and articles incorporated into the Work shall be new and of equal quality to the types and grades specified. When not particularly specified, the Contractor shall submit for approval satisfactory evidence as to the kind and quality of material. See SUBSTITUTION provision 5.3 concerning "or equal" requirements and procedure for submitting alternative material, articles, or equipment.
- 8.8.2** All materials shall be delivered so as to insure a speedy and uninterrupted progress of the Work. All materials shall be stored so as to cause no obstruction and so as to prevent overloading of any portion of the structure on the Work site, and the Contractor shall be entirely responsible for damage or loss by weather, theft, vandalism, or other cause.
- 8.8.3** Materials shall be stored to assure the preservation of their quality and fitness for the Work. Stored materials shall be reasonably accessible for inspection. When considered necessary by the County, stored materials shall be placed on wooden platforms or on other hard, clean surfaces and not directly on the ground, and shall be

placed under cover when so directed.

8.9 LAYOUT OF WORK

8.9.1 The Contractor shall lay out its work from established base lines and bench marks indicated on the drawings, and shall be responsible for all measurements in connection with the layout. The Contractor shall furnish, at its own expense, all stakes, templates, platforms, equipment, tools, material, and labor required to lay out any part of the Work. The Contractor shall be responsible for executing the Work to the lines and grades that may be established or indicated in the Contract Documents. The Contractor shall also be responsible for maintaining and preserving all stakes and other marks established by the County until authorized to remove them. If such marks are destroyed by the Contractor before their removal is authorized, the County may replace them and deduct the expense of the replacement from any amounts due or to become due to the Contractor.

8.10 USE OF PREMISES

8.10.1 The Contractor shall maintain the entire premises under his control in an orderly condition. He shall store his apparatus, materials, supplies and equipment in such a manner as will not interfere with the progress of his work or the work of other contractors.

8.11 OPERATIONS & STORAGE

8.11.1 The Contractor shall confine all operations (including storage of materials) on County premises to areas authorized or approved by the County.

8.11.2 Temporary buildings (e.g., storage sheds, shops, offices) and utilities may be erected by the Contractor only with the approval of the County and shall be built with labor and materials furnished by the Contractor without expense to the County. The temporary buildings and utilities shall remain the property of the Contractor and shall be removed by the Contractor at his expense upon completion of the work.

8.11.3 The Contractor shall, under regulations prescribed by the authority having jurisdiction, use only established roadways, or use temporary roadways constructed by the Contractor when and as authorized by the authority having jurisdiction. When materials are transported in performance of the Work, vehicles shall not be loaded beyond the loading capacity recommended by the manufacturer of the vehicle or prescribed by any Federal, State, or County regulation. When it is necessary to cross curbs or sidewalks, the Contractor shall protect them from damage. The Contractor shall repair, or pay for the repair, of any damaged curbs, sidewalks, or roads.

8.12 HEAT/POWER/LIGHT

8.12.1 Unless otherwise specified or already provided by the County, the Contractor shall:

- a. Provide heat, as necessary to protect all work, materials, and equipment against injury from dampness and cold;
- b. Provide heat as necessary in the area where work is to be done to provide the minimum temperature recommended by the supplier or manufacturer of the material;
- c. Provide electric power and light as required for performance of the Work.

8.13 CLEANING UP

8.13.1 The Contractor shall at all times keep the work area, including storage areas, free from accumulations of waste

materials. Before completing the Work, the Contractor shall remove from the work and premises any weeds, rubbish, tools, scaffolding, equipment, and materials that are not the property of the County. Upon completing the Work, the Contractor shall leave the work area in a clean, neat, and orderly condition satisfactory to the County.

ARTICLE 9 SAFETY & HEALTH

9.1 ACCIDENT PREVENTION

9.1.1 In performing this Contract, the Contractor shall provide for protecting the lives and health of employees and other persons; preventing damage to property, materials, supplies, and equipment; and avoiding work interruptions. For these purposes, the Contractor shall:

- a. Provide a copy of its safety program;
- b. Provide appropriate safety barricades, signs, and signal lights;
- c. Comply with standards issued by the U.S. Government, State, County and City, and other governing agencies having jurisdiction;
- d. Ensure that any additional measures the County determines to be reasonably necessary for this purpose are taken.

9.1.2 The Contractor shall maintain an accurate record of exposure data on all accidents incident to work performed under this Contract resulting in death, traumatic injury, occupational disease, or damage to property, materials, supplies, or equipment. The Contractor shall report this data in the manner prescribed by the County.

9.1.3 Before beginning excavation for a trench 5 feet or more in depth, Contractor shall provide evidence of having obtained a permit from the authority having jurisdiction.

9.1.4 Nothing herein shall be deemed to allow use of shoring, sloping, or protective systems less effective than those required by the Construction Safety Orders of the California Division of Industrial Safety.

9.2 SANITARY FACILITIES

9.2.1 Contractor shall supply and maintain at its expense such toilets and other sanitary facilities including those which are accessible by the disabled as per ADA and Title 24 requirements necessary for use by visitors and workers employed at the job site. Such facilities shall be approved by the County.

9.3 RESPONSIBILITY FOR COMPLIANCE WITH CAL-OSHA

9.3.1 All work, materials, work safety procedures and equipment shall be in full accordance with the latest Cal-OSHA rules and regulations.

9.3.2 Contractor warrants that he and each of his subcontractors shall, in performance of this Contract, comply with each and every compliance order issued pursuant to Cal-OSHA. The Contractor assumes full and total responsibility for compliance with Cal-OSHA standards by his subcontractors as well as himself. The cost of complying with any order and/or payment of any penalty assessed pursuant to Cal-OSHA shall be borne by the Contractor. Nothing contained therein shall be deemed to prevent the Contractor and his subcontractors from otherwise allocating between themselves responsibility for compliance with Cal-OSHA requirements; provided, however, that the Contractor shall not thereby, in any manner whatsoever, be relieved of his

responsibility to the County as herein set forth.

9.4 TOXIC AND HAZARDOUS MATERIALS AND WASTE

9.4.1 ASBESTOS

Operations which may cause release of asbestos fibers into the atmosphere shall meet the requirements of Title 8 CCR General Industrial Safety Orders, Section 5208 and California law. Some operations which may cause such concentrations include sanding, grinding, abrasive blasting, sawing, drilling, shoveling, or otherwise handling materials containing asbestos so that dust will be raised.

9.4.2 TOXIC MATERIALS

Operations which release toxic materials into the atmosphere shall meet the requirements of Title 8 CCR, General Industrial Safety Orders. Some operations which may release such materials include use of adhesives, sealants, paint, and other coatings.

9.4.3 LEAD-BASED PAINT

Lead-based paint is prohibited. Lead-based paint is defined as:

- a. Any paint containing more than five-tenths of one percentum lead by weight (calculated as lead metal in the total non-volatile content of the paint) or the equivalent measure of lead in the dried film of paint applied or both; or
- b. For paint manufactured after June 22, 1977, any paint containing more than six one-hundredths of one percentum lead by weight (calculated as lead metal) in the total content of the paint or the equivalent measure of lead in the dried film or paint already applied.

9.4.4 HAULING AND DISPOSAL

All hauling and disposal shall meet requirements of Title 22 CCR, Division 4, Chapter 30, "Minimum Standards for Management of Hazardous and Extremely Hazardous Wastes."

9.4.5 ASBESTOS PROHIBITED

No products or materials containing asbestos shall be incorporated into the Work without the prior written approval of the County.

ARTICLE 10 COUNTY-FURNISHED PROPERTY

10.1 COUNTY-FURNISHED PROPERTY

10.1.1 The County may furnish to the Contractor property as identified in the specification(s) to be incorporated or installed into the Work or used in performing the Contract. The listed property will be furnished f.o.b. railroad cars at the place specified in the Contract or f.o.b. truck at the project site. The Contractor is required to accept delivery. When the property is delivered, the Contractor shall verify its quantity and condition and acknowledge receipt in writing to the County within twenty-four (24) hours of delivery, also specifying any damage to or shortage of the property as received. All such property shall be installed or incorporated into the Work at the expense of the Contractor, unless otherwise indicated in this Contract.

- 10.1.2** Each item of property to be furnished under this clause shall be identified by the Contractor in a schedule by quantity, item, and description. Schedule form will be provided by the County.
- 10.1.3** The Contractor shall be held responsible for all material delivered to him and deductions will be made from any moneys due him to make good any shortages and deficiencies, from any cause whatsoever, which may occur after such delivery.
- 10.1.4** The Contractor shall set up accounting records and establish an inspection procedure as approved by the County.

ARTICLE 11 **BENEFICIAL OCCUPANCY**

11.1 **BENEFICIAL OCCUPANCY**

- 11.1.1** The County shall have the right to take possession of or use any completed or partially completed portion of the Work. The County's possession or use shall not be deemed an acceptance of any Work under the Contract. The Contractor will continue to pay for any portion of the utilities which he is using.
- 11.1.2** While the County has such possession or use, the Contractor shall be relieved of the responsibility for the loss of or damage to that portion of the Work resulting from the County's possession or use. If Contractor believes the partial possession or use by the County will delay the progress of the Work or will cause additional expense to the Contractor, Contractor shall immediately submit a written request for an equitable adjustment in the Contract price or the time of completion. County will then consider such request and, if in its judgment it is justified, the County will modify the contract in writing accordingly. In the event the Contractor disagrees with the County's decision, the Contractor shall be required to submit a claim pursuant to the DISPUTE article.

ARTICLE 12 **INSPECTION AND TESTING**

12.1 **INSPECTION AND TESTING**

- 12.1.1** The Contractor shall maintain an adequate inspection system and perform such inspections as will ensure that the work called for by this Contract conforms to contract requirements. The Contractor shall maintain complete inspection records and make them available to the County. The County shall at all times have access to the Work, and the Contractor shall provide proper facilities for such access and for inspection.
- 12.1.2** County inspections and tests are for the sole benefit of the County and do not:
- a. Relieve the Contractor of responsibility for providing adequate quality control measures;
 - b. Relieve the Contractor of responsibility for damage to or loss of the material before Acceptance;
 - c. Constitute or imply Acceptance; or
 - d. Affect the continuing rights of the County after Acceptance regarding latent defects, gross mistakes, fraud or the County's rights under any warranty or guarantee.
- 12.1.3** The presence or absence of a County inspector does not relieve the Contractor from any Contract requirement, nor is the inspector authorized to change any term or condition of the specifications without the County's written authorization.

- 12.1.4** The Contractor shall promptly furnish, without additional charge, all facilities, labor, and material reasonably needed for performing such safe and convenient inspections and tests as may be required by the County. The County may charge to the Contractor any additional cost of inspection or test when work is not ready at the time specified by the Contractor for inspection or test, or when prior rejection makes reinspection or retest necessary. Special, full size, and performance tests shall be performed as described in the Contract.
- 12.1.5** The Contractor shall, without charge, replace or correct work found by the County not to conform to contract requirements, unless in the public interest the County consents to accept the work with an appropriate adjustment in Contract price. The Contractor shall promptly segregate and remove rejected material from the premises.
- 12.1.6** If, before Acceptance of the Work, the County decides to examine already completed work by removing it or tearing it out, the Contractor, on request, shall promptly furnish all necessary facilities, labor, and material. If the work is found to be defective or nonconforming in any material respect due to the fault of the Contractor or its subcontractors, the Contractor shall defray the expenses of the examination and of satisfactory reconstruction. However, if the work is found to meet Contract requirements, the County shall issue a Change Order for such removal and reinstallation.
- 12.1.7** The Contractor shall at all times maintain proper facilities and provide safe access for inspection by the County to all parts of the work, and to the shops wherein the work is in preparation. Where the specifications require work to be specially tested or approved, it shall not be tested or covered up without timely notice to the County of its readiness for inspection and without the approval or consent of County. Should any such work be covered up without such notice, approval, or consent, it must, if required by County, be uncovered for examination at the Contractor's expense.
- 12.1.8** The Contractor shall notify the County at least one (1) work day in advance of the time scheduled for the inspection. Should the Contractor fail to notify the County and proceed with work requiring inspection, all such work is rejected, and no further work shall be done on that portion of the project until the rejected work is accepted by the County. Should the Contractor request acceptance of such rejected work the County shall, at the Contractor's expense, secure the services of private material testing laboratories, consulting engineers or licensed land surveyors, who shall certify that said work does in fact conform to the requirements of the Contract Documents. The work previously rejected shall be accepted by the County after receipt of such certification if the County approves of such certification.
- 12.1.9** If the Contractor does not promptly replace or correct rejected work, the County may (1) by contract or otherwise, replace or correct the work and charge the cost to the Contractor or (2) terminate for default the Contractor's right to proceed.
- 12.1.10** Construction review of the Contractor's performance by the County is not intended to include the review of the adequacy of the Contractor's safety measures, in, on, or near the construction site.
- 12.1.11** The County will pay for initial testing services specified to be performed by the County. When initial tests indicate non-compliance with the Contract Documents, subsequent retesting occasioned by the non-compliance shall be performed by the same testing agency, and costs thereof will be deducted by the County from the Contract sum.

12.2 INSPECTION BY OTHER JURISDICTIONS

Whenever any part of the Work to be performed is under the jurisdiction or control of another public entity, including but not limited to: The United States Government, State of California, or City, such work shall be

subject to inspection by the officials of such entities and it must pass inspection, in addition to County inspection, and such other inspections as may otherwise be provided for in the Contract Documents.

12.3 FINAL INSPECTION AND TESTS

The Contractor shall give the County at least ten (10) calendar days advance written notice of the date the Work will be fully completed and ready for final inspection and tests. Final inspection and tests will be started within ten (10) calendar days from the date specified in the aforementioned notice unless the County determines that the Work is not ready for final inspection and so informs the Contractor.

ARTICLE 13 ACCEPTANCE

13.1 ACCEPTANCE OF THE WORK

13.1.1 After the final inspection by County and all the contract documentation has been received, it will be recommended to the County Board of Supervisors to accept the Work and file a Notice of Completion. Upon approval of the Notice of Completion, a copy will be sent to the Contractor. (See final payment clause.) Upon Acceptance of the Work, Contractor will be relieved of the duty of maintaining and protecting the Work. Neither determination by the County that the Work is complete, nor Acceptance thereof, shall operate as a bar to County's claim against Contractor pursuant to Contractor's warranty and guarantees.

13.1.2 Partial payments shall not be construed as acceptance of any part of the Work.

13.1.3 In judging the Work, no allowance for deviations from the drawings and specifications will be made, unless already approved in writing at the time and in the manner as called for herein.

13.1.4 County shall be given adequate opportunity to make any necessary arrangements for fire insurance and extended coverage.

13.1.5 The Acceptance of the Work will not be recommended until all requirements of the Contract Documents are complete and approved by the County. This shall include, but is not limited to, all construction, guarantee forms, parts lists, schedules, tests, operating instructions, as-built drawings, and all other documentation identified by the Contract Documents.

ARTICLE 14 WARRANTY AND GUARANTEES

14.1 CONTRACTOR'S WARRANTY AND GUARANTEE

14.1.1 Contractor warrants that all materials and equipment furnished under this Contract shall be new unless otherwise specified, and that all Work performed under this Contract conforms to the Contract requirements and is free of any defect whether performed by the Contractor or any subcontractor or supplier.

14.1.2 This warranty shall continue for a period of one (1) year from the date of filing of Notice of Completion on the Work. The Performance Bond shall remain in force during the warranty period.

14.1.3 The Contractor shall remedy at the Contractor's expense any damage to County-owned or controlled real or personal property, when that damage is the result of:

- a. The Contractor's failure to conform to Contract requirements or
- b. Any defect of equipment, material, workmanship, or design furnished by the Contractor.

- 14.1.4** The Contractor shall restore any work damaged in fulfilling the terms and conditions of this Article. The Contractor's warranty with respect to work repaired or replaced will run for one (1) year from the date of repair or replacement.
- 14.1.5** The County shall notify the Contractor, in writing, within a reasonable time after the discovery of any failure, defect, or damage. The Contractor shall within ten (10) calendar days after being notified in writing by the County of any work not in accordance with the requirements of the Contract or any defects in the Work, commence, and perform with due diligence, all work necessary to fulfill the terms of this Article. If the Contractor fails to remedy any defect, or damage within fourteen (14) calendar days after receipt of notice, the County shall have the right to replace, repair, or otherwise remedy the defect, or damage at the Contractor's expense. Payment due to the Architect from the County for extra architectural services required in the enforcement of Contractor's guarantee after Acceptance of the Work shall be paid to the County by the Contractor.
- 14.1.6** In the event of any emergency constituting an immediate hazard to health or safety of County employees, property, or licensees, when caused by work of the Contractor that is not in accordance with the Contract requirements, the County may undertake at Contractor's expense and without prior notice, all work necessary to correct such hazardous condition(s).
- 14.1.7.** With respect to all warranties, express or implied, from subcontractors, manufacturers, or suppliers for work performed and materials furnished under this Contract, the Contractor shall:
- a. Obtain all warranties that would be given in normal commercial practice;
 - b. Require all warranties to be executed, in writing, for the benefit of the County, unless directed otherwise by the County; and
 - c. Enforce all warranties for the benefit of the County, unless otherwise directed by the County.
- 14.1.8** This warranty shall not limit the County's rights under the Inspection and Acceptance section(s) of this Contract with respect to latent defects, gross mistakes, or fraud.

ARTICLE 15 ENVIRONMENTAL PROTECTION

15.1 DUST CONTROL

15.1.1 The Contractor shall provide any and all dust control required.

15.1.2 Whenever the Contractor is negligent in providing dust control, the County shall order the Contractor to provide such dust control. If the Contractor does not comply promptly with such order, the County shall have the authority to provide such dust control and charge the Contractor therefore by deducting the cost from progress payments to the Contractor as such costs are incurred by the County. The County shall not be held responsible for schedule delays due to actions taken by County to mitigate the failure of the Contractor in providing dust control.

15.2 EXCESSIVE NOISE

15.2.1 The Contractor shall use only such equipment on the Work and in such state of repair, that the emission of sound therefrom is within the noise tolerance level of that equipment as established by CAL-OSHA.

15.2.2 Should the County determine that the muffling device on any equipment used on the Work is ineffective or defective so that the noise tolerance of such equipment is exceeded, such equipment shall not, after such determination by the County, be used on the Work until its muffling device is repaired or replaced so as to bring the noise tolerance level of such equipment within such standards.

15.3 POLLUTION CONTROL, CLEANING

15.3.1 The Contractor shall not, in connection with the Work, discharge any smoke, dust, or other contaminants into the atmosphere which are in violation of South Coast Air Quality Management District standards or discharge any fluids or materials into any lake, river, stream, or channel as will violate regulations of State of California Water Resources Board. The Contractor shall control accumulation of waste materials and rubbish and dispose of waste materials and rubbish off-site at a minimum of weekly intervals. Burning of materials is not permitted.

ARTICLE 16 EMPLOYMENT PRACTICES

16.1 QUALIFICATIONS FOR EMPLOYMENT AND APPRENTICESHIP STANDARDS

16.1.1 In accordance with Section 1735 of the California Labor Code, no person under the age of 16 years and no person currently serving sentence in a penal or correctional institution shall be employed to perform any Work under this Contract. No person whose age or physical condition is such as to make his employment dangerous to his health or safety or to the health or safety of others shall be employed to perform Work under this Contract; provided that this requirement shall not operate against any physically handicapped persons otherwise employable where such persons may be safely assigned to Work which they ably perform.

16.1.2 This contract is subject to the provisions of Sections 1777.5 and 1777.6 of the California Labor Code concerning the employment of apprentices by the Contractor or any subcontractor under him. Section 1777.5 as amended, requires the Contractor or subcontractor employing tradesmen in any apprenticeable occupation to apply to the Joint Apprenticeship Committee nearest the site of this project and which administers the apprenticeship program in that trade for a certificate of approval. The certificate will also fix the ratio of apprentices to journeymen that will be used in the performance of the Contract.

16.1.3 The Contractor is required to make contributions to funds established for the administration of apprenticeship programs if he employs registered apprentices or journeymen in any apprenticeable trade on such contracts and if other contractors on the public works site are making contributions.

16.1.4 All employees engaged in work on the project under this Contract shall have the right to organize and bargain collectively through representatives of their own choosing, and such employees shall be free from interference, restraint, and coercion of employers in the designation of such employees for the purpose of collective bargaining or other mutual aid or protection, and no person seeking employment under this Contract shall be required as a condition of initial or continued employment to join any company, union, or to refrain from joining, organizing, or assisting a labor organization of such person's own choosing. No person in the employment of the County shall be employed by this contractor.

16.2 WAGES & RECORDS

16.2.1 WAGE RATES

- a. Pursuant to Section 1770 and 1773 et seq. of the Labor Code of the State of California, the Director of Industrial Relations has ascertained the general prevailing rate of per diem wages and the rates for overtime and holiday work in the locality in which the work is to be performed for each craft, classification, or type of workman needed to execute the contract

which will be awarded to the successful bidder, copies of which are on file and available upon request at the Clerk of the Board, Board of Supervisors, 4080 Lemon St., 14th Floor, Riverside, CA 92501-3655, and shall be posted at the job site.

- b. It shall be mandatory upon the Contractor and upon any subcontractor under him, to pay not less than the said specified rates to all laborers, workmen, and mechanics employed in the execution of the Contract. It is further expressly stipulated that the Contractor shall, as a penalty to County, forfeit twenty-five dollars (\$25.00) for each calendar day, or portion thereof, for each laborer, workman, or mechanic paid less than the stipulated prevailing rates for any work done under this Contract by him or by any subcontractor under him; and Contractor agrees to comply with all provisions of Section 1770 et. seq. of the Labor Code.
- c. In case it becomes necessary for the Contractor or any sub-contractor to employ on the project under this Contract any person in a trade or occupation (except executives, supervisory, administrative, clerical, or other non-manual workers as such) for which no minimum wage rate is herein specified, the Contractor shall immediately notify the County who will promptly thereafter determine the prevailing rate for such additional trade or occupation and shall furnish the Contractor with the minimum rate based thereon. The minimum rate thus furnished shall be applicable as a minimum for such trade or occupation from the time of the initial employment of the person affected and during the continuance of such employment.
- d. The County will not recognize any claim for additional compensation because of the payment by the Contractor of any wage rate in excess of the prevailing wage rate set forth as provided herein. The possibility of wage increases is one of the elements to be considered by the Contractor in determining his bid, and will not under any circumstances be considered as the basis of a claim against the County on the Contract.

16.2.2 WAGE RECORDS

- a. The Contractor and each subcontractor shall keep or cause to be kept an accurate record (certified payroll) showing the names and occupations of all laborers, workers, and mechanics employed by him in connection with the execution of this Contract or any subcontract thereunder. The record shall show the actual per diem wages paid to each of said workers, which records shall be provided to the County, and to the Division of Labor Standards Enforcement upon its request. Copies provided will include one which has the name and social security numbers marked out.

16.3 NOTICE OF LABOR DISPUTES

- 16.3.1** If the Contractor has knowledge that any actual or potential labor dispute is delaying or threatens to delay the timely performance of this Contract, the Contractor shall immediately give notice, including all relevant information, to the County.
- 16.3.2** The Contractor agrees to insert the substance of this clause, including this paragraph into any subcontract in which a labor dispute may delay the timely performance of this Contract; except that each subcontract shall provide that in the event its timely performance is delayed or threatened by delay by any actual or potential labor dispute, the subcontractor shall immediately notify the next higher tier subcontractor or the prime Contractor, as the case may be, of all relevant information concerning the dispute.

16.4 NONDISCRIMINATION

16.4.1 EQUAL EMPLOYMENT OPPORTUNITY

- a. Contractor agrees for the duration of this Contract that it will not discriminate against any employee or applicant for employment because of race, color, religion, sex, national origin, age, political affiliation, marital status, or handicap. The Contractor will take affirmative action to insure that employees are treated during employment or training without regard to their race, color, religion, sex, national origin, age, political affiliation, marital status, or handicap. Such action shall include, but not be limited to, the following: employment, upgrading, demotion, or transfer; recruitment or recruitment advertising; layoff or termination; rates of pay or other forms of compensation; and selection for training, including apprenticeship. The Contractor agrees to post in conspicuous places, available to employees and applicants for employment, notices to be provided setting forth the provisions of this nondiscrimination clause.
- b. The Contractor will in all solicitations or advertisements for employees placed by or on behalf of the Contractor, state that all qualified applicants will receive consideration for employment without regard to race, color, religion, sex, national origin, age, political affiliation, marital status, or handicap.
- c. The Contractor will send to each labor union or other representative of workers with which it has a collective bargaining agreement or other contract or understanding, a notice advising the workers' representative of the Contractor commitments under this agreement.
- d. The Contractor agrees that it will comply with the provisions of Titles VI and VII of the Civil Rights Act, Revenue Sharing Act Title 31, U.S. Code Section 2716, and California Government Code Section 12990.
- e. The Contractor agrees that it will assist and cooperate with the County, the State of California and the United States Government in obtaining compliance with the equal opportunity clause, rules, regulations, and relevant orders of the State of California and United States Government issued pursuant to the Acts.
- f. In the event of the Contractor's non-compliance with the discrimination clause, the affirmative action plan of this contract, or with any of the said rules, regulations or orders, this Contract may be canceled, terminated, or suspended in whole or in part by the County.

16.4.2 HANDICAPPED NON-DISCRIMINATION

This project is subject to Section 504 of the Rehabilitation Act of 1973 as amended, (29 U.S.C. 794), and the Americans with Disabilities Act of 1990, as amended, and all requirements imposed by the guidelines and interpretations issued thereto. In this regard, the County and all of its contractors and subcontractors will take all reasonable steps to ensure that handicapped individuals have the maximum opportunity for the same level of aid, benefit or service as any other individual.

16.4.3 FAIR EMPLOYMENT AND HOUSING ACT ADDENDUM

In the performance of this Contract, the Contractor will not discriminate against any employee or Applicant for employment because of race, sex, color, religion, ancestry, or national origin. The Contractor will take affirmative action to ensure that applicants are employed, and that employees are treated during employment,

without regard to their race, sex, color, religion, ancestry, or national origin. Such action shall include, but not limited to, the following: employment, upgrading, promotion, or transfer; recruitment or recruitment advertising; layoff or termination; rates of pay or other forms of compensation; and selection for training, including apprenticeship. The Contractor shall post in conspicuous places, available to employees and applicants for employment, notices to be provided by the State or local agency setting forth the provisions of this Fair Employment and Housing Section.

16.4.4 ACCESS TO RECORDS

The Contractor will permit access to his records of employment, employment advertisements, application forms, and other pertinent data and records by the State Fair Employment and Housing Commission, or any other agency of the State of California designated by the awarding authority, for the purposes of investigation to ascertain compliance with the Fair Employment and Housing section of this Contract.

16.4.5 REMEDIES FOR WILLFUL VIOLATION

The State or local agency may determine a willful violation of the Fair Employment and Housing provision to have occurred upon receipt of a final judgment having that effect from a court in an action to which Contractor was a party, or upon receipt of a written notice from the Fair Employment and Housing Commission that it has investigated and determined that the Contractor has violated the Fair Employment and Housing Act and has issued an order or obtained an injunction under Government Code Sections 12900, et seq.

ARTICLE 17 SUBCONTRACTING

17.1 SUBCONTRACTORS

17.1.1 A subcontractor is an individual, firm or corporation having a direct contract with the Contractor or with any other subcontractor for the performance of a part of the Work. In accordance with Section 4104 of the Public Contract Code, each Contractor, in his bid, shall include the name and location of each subcontractor who will perform work or labor, or render services to the Contractor in or about the Work in an amount in excess of one half of 1% of the Contractor's total bid.

17.1.2 The County reserves the right to approve all subcontractors. Such approval shall be a consideration to the awarding of the Contract and unless notification to the contrary is given to the Contractor prior to the signing of the Contract, the list of subcontractors which is submitted with his proposal will be deemed to be acceptable.

17.1.3 The Contractor shall be as fully responsible to the County for the acts and omissions of his subcontractors and of persons either directly or indirectly employed by them, as he is for the acts and omissions of persons directly employed by him.

17.1.4 Nothing contained in the Contract Documents shall create any contractual relationship between any subcontractor and the County.

17.1.5 The divisions or sections of the specifications are not intended to control the Contractor in dividing the Work among subcontractors or to limit the work performed by any trade.

17.2 RELATIONS OF CONTRACTOR AND SUBCONTRACTOR

17.2.1 The Contractor agrees to bind every subcontractor by the terms of the Contract with the County, the General Conditions, Supplementary Conditions, and the drawings and specifications as far as applicable to his work, unless specifically noted to the contrary in a subcontract approved in writing as adequate by the County.

17.3 SUBCONTRACTS

17.3.1 Pursuant to the provisions of Sections 4100 to 4114 of the California Public Contract Code, inclusive, the Contractor shall not, without the consent of the County, either:

- a. Substitute any persons as subcontractors in place of the subcontractors designated in his original bid without the consent of County. (The County's consent can only be given in cases permitted by Public Contract Code Section 4107.)
- b. Permit any subcontract to be assigned or transferred or allow any work to be performed by anyone other than the original subcontractor listed in his bid.
- c. Sublet or subcontract any portion of the work in excess of one-half of one percent of his bid to which his original bid did not designate a subcontractor.

Should the Contractor violate any of the provisions of Sections 4100 to 4114, inclusive, of the Public Contract Code, his so doing shall be deemed a violation of this Contract, and the County may either cancel the contract, or assess the Contractor a penalty in the amount of not more than ten (10) percent of the amount of the subcontract involved, or both.

ARTICLE 18 TAXES

18.1 SALES AND PAYROLL TAXES

18.1.1 Each Contractor, subcontractor, and material dealer shall include in their bid all applicable taxes including but not limited to sales tax and payroll taxes required by law.

ARTICLE 19 CHANGES

19.1 CHANGE ORDER WORK

19.1.1 The County reserves the right to make changes in the work without impairing the validity of the Contract. The County may make changes to the work, or suspend the work, and all such changes or suspension are within the contemplation of the parties and will not be a basis for compensable delay. Such changes may be made in accordance with any of the following methods:

- a. By written change order to the Contract ordered by the Board of Supervisors.
- b. By written change order, signed by the Assistant County Executive Officer/EDA, in the manner and amounts specified by Board Policy B-11.
- c. By written authorization, issued by the Assistant County Executive Officer/EDA, for items of work done under unit prices. The cost or credit for such added or omitted work shall be determined by multiplying the number of units added to or omitted from the work by the applicable unit price.

19.1.2 Upon receipt of a proposed Change Order from County, the Contractor shall submit a proposal in accordance with the requirements and limitations set forth in this "Change Orders" article, for work involved in the contemplated change.

- 19.1.3** The Contractor must submit a cost proposal within fifteen (15) calendar days after receipt of the proposed change order. The Contractor must submit cost proposals in less than fifteen (15) calendar days if requested by the County or if required by schedule limitations.
- 19.1.4** If the Contractor fails to submit the cost proposal within the 15-day period (or as requested), the County has the right to order the Contractor in writing to commence the work immediately on a force account basis and/or issue a lump sum change to the contract price in accordance with the County's estimate of cost. If the change is issued based on the County estimate, the Contractor will waive his right to dispute the action unless within fifteen (15) calendar days following completion of the added/deleted work, the Contractor presents proof that the County's estimate was in error.
- 19.1.5** If the County disagrees with the proposal submitted by Contractor, it will notify the Contractor in writing and the Contractor may elect to proceed under the DISPUTE article of this Contract, or, in the event either party contests the price or time extension of Change work, or time is of the essence, the County may issue a Construction Change Directive and the contractor shall proceed with the work. The County will provide its opinion of the appropriate price and/or time extension in a "Response to Change Order Request." If the contractor agrees with the County's estimate, a change order will be issued by the County. If no agreement can be reached, the County shall have the right to issue the Change Order Directive setting forth its unilateral determination of the reasonable additions or savings in costs and time attributable to the extra or deleted work. Such determination shall become final and binding if the Contractor fails to submit a Claim in writing to the County, within twenty-one (21) days of the Change Order Directive, disputing the terms of such Directive. No dispute, disagreement or failure of the parties to reach agreement regarding the amount, if any, of any adjustment to the contract sum or contract time shall relieve the Contractor from the obligation to proceed with performance of the work, including extra work, promptly and expeditiously."
- 19.1.6** The Contractor will give notice of a requested change on his letterhead within seven (7) calendar days of discovery and, if the County agrees, a proposed change order will be issued on the County's standard change order form.
- 19.1.7** If any change involves an increase or decrease in the cost of the Contractor's work, a change order shall state the amount to be added or deducted from the Contract amount, and the additional time, if any, needed for the performance of such work.
- 19.1.8** Any changes to the Contract amount shall be in a lump sum mutually agreed to by the Contractor and the County, except that when, in the opinion of the County, such basis is not feasible the change to the Contract amount shall be determined upon a cost-plus-percentage basis with a guaranteed maximum lump sum cost within the limitations provided by law.
- 19.1.9** Each lump sum quotation from the Contractor shall be accompanied by sufficiently detailed estimates to permit verification of totals in accordance with (a) through (d) in 19.1.11 below.
- 19.1.10** When the work is to be done on a cost-plus-percentage basis, the Contractor shall submit statements as required by the County showing all labor, material, and equipment costs incurred, and upon completion of the work, a summary of costs, including overhead and profit, and in accordance with Item (a) through (d) in 19.1.11 below.
- 19.1.11** Estimates for lump sum quotations and accounting for cost-plus-percentage work shall be limited to direct expenditures necessitated specifically by the subject extra work, and shall be segregated as follows:
- a. Labor. The costs of labor will be the actual cost for wages prevailing locally for each craft

or type of worker at the time the extra work is done, plus employer payments of payroll taxes and insurance, health and welfare, pension, vacation, apprenticeship funds, and other direct costs resulting from Federal, State or local laws, as well as assessment or benefits required by lawful collective bargaining agreements. The use of a labor classification which would increase the extra work cost will not be permitted unless the contractor establishes the necessity for such additional costs. Labor costs for equipment operators and helpers shall be reported only when such costs are not included in the invoice for equipment rental.

- b. **Materials.** The cost of materials reported shall be at invoice or lowest current price at which such materials are locally available in the quantities involved, plus sales tax, freight and delivery.
- c. **Tool and Equipment Use.** No payment will be made for the use of tools which have a replacement value of \$100 or less. Regardless of ownership, the rates to be used in determining equipment use costs shall not exceed listed rates prevailing locally at equipment rental agencies, or distributors, at the time the work is performed.
- d. **Overhead, Profit and Other Charges.** The mark-up for overhead and profit on work added to the Contract shall be according to the following Schedule.
 - (1) For work performed by the Contractor's forces the added cost for overhead and profit shall not exceed fifteen (15%) percent of the net cost of the work, equipment, labor and materials.
 - (2) For work performed by a subcontractor, the added cost for overhead and profit shall not exceed fifteen (15%) percent of the net cost of the work, equipment, labor and materials, to which the Contractor may add five (5) percent of the subcontractor's price of the work.
 - (3) For work performed by a sub-subcontractor the added cost for overhead and profit shall not exceed fifteen (15 %) percent of the net cost for work, equipment, labor and materials to which sub-contractor and general contractor may each add an additional five (5 %) percent of the total price from the lower tier subcontractor.
 - (4) "Net Cost" is defined as consisting of costs of labor, materials and equipment use and/or rental only. The costs of applicable insurance and bond premium will be reimbursed to the Contractor and subcontractors at cost only, without mark-up.
 - (5) The cost of direct supervision, except when provided by working foreman whose time is included above, of change order work when done exclusively, and not in conjunction or at the same time as, other work performed on the job and when approved in advance by the County's authorized representative, including only payroll taxes, insurance, pension and direct costs for the labor of supervision may be charged to the change order. The cost of transportation, use of vehicle and other costs incurred by supervision will not be allowed.

19.1.12 For added or deducted work by subcontractors, the Contractor shall furnish to the County the subcontractor's signed detailed estimate of the cost of labor, material and equipment, including the markup by such subcontractor for overhead and profit. The same requirement shall apply to sub-subcontractors.

- 19.1.13** For added or deducted work furnished by a vendor or supplier, the Contractor shall furnish to the County a detailed estimate or quotation of the cost to the Contractor for such work, signed by such vendor or supplier.
- 19.1.14** Any change in the work involving both extras and credits shall show a new total cost, including subcontracts. Allowance for overhead and profit, as specified therein, shall be applied if the net total cost is an extra; overhead and profit allowances shall not be applied if the net total cost is a credit. The estimated cost of deductions shall be based on labor and material prices on the date the Contract was executed.
- 19.1.15** The Contractor shall identify any adjustment in time of the final completion of the Work as a whole which is directly attributable to the changed work within fifteen (15) calendar days of receipt of the proposed change order. The Contractor's request for a change in time will be supported by a detailed schedule analysis including a schedule indicating the activities which have been affected and the additional time being requested.
- a. For a change in time for the Work, the Contractor shall be entitled only to such adjustments where completion of the entire Work (critical path) is delayed due to the performance of the changed work. Failure to request extra time when submitting such estimate shall constitute waiver of the right to subsequently claim adjustment in time for final completion based upon such changed work.
 - b. If the County and the Contractor fail to arrive at an agreement on the amount of extra cost, credit or time extension for a proposed change, a change order will be processed in the amount believed by the County to be reasonable, and the Contractor shall proceed with the work. If the Contractor believes that the amount or time stipulated in the change order is not reasonable for the work required, he may elect to issue a notification in accordance with the DISPUTES article for review by the County, stating therein the basis for his dispute with such change order.
- 19.1.16** Any change in the Work shall conform to the original Contract Documents insofar as they may apply without conflict to the conditions involved in the change.
- 19.1.17** Payment for additional work or extras, if any, shall become due and payable in accordance with the provisions for payment in the Contract.
- 19.1.18** Contractor shall not reserve a right to assess impact cost, extended job site costs, extended overhead, and/or constructive acceleration at a later date as related to any and all changes. All costs or estimated costs must be supported with full schedule and cost documentation with each proposed change within the prescribed submission times. If a request for a change is denied and the Contractor disputes the denial, the Contractor must supply the aforementioned documentation to support his claim under the DISPUTES article of this Contract. No claims shall be allowed for impact, extended overhead costs, and/or construction acceleration due to the multiplicity of changes and/or clarifications. Any attempt by Contractor to change or modify the change order form (sample included herein) shall void the form, including any letters the Contractor may issue in conjunction therewith.
- 19.1.19** All alterations, extensions of time, extra and additional work and other changes authorized by these specifications or any part of the Contract may be made without securing consent of the surety or sureties on the contract bonds.

19.2 CHANGE ORDERS AND LABOR RATES GUIDELINES

- 19.2.1** The following are guidelines for preparing change orders:

a. Labor Rates:

- (1) To establish the labor rate for each classification and trade, a breakdown shall be submitted to the County.
- (2) Labor rates are based on current prevailing state and federal wages. Only those benefits mandated by law or a valid labor contract are paid by the County.
- (3) Payroll taxes shall be paid as mandated by law. Labor related insurances shall be paid according to industry standard average.
- (4) No other costs related to labor shall be paid by County.

b. Change Orders:

- (1) Change orders shall be prepared in accordance with the project contract.
- (2) No insurance costs are paid by County, except for labor insurances specified in this guideline under section 1 titled "LABOR RATES".
- (3) Material cost shall be broken down on a separate sheet, and for those jobs designated as time and material shall be supported by valid invoices from suppliers.
- (4) Hours for non-productive labor, such as non-working foremen or general foremen, shall be paid only when justified in the opinion of the County, and approved by the County. The total number of nonproductive labor hours shall be limited to a maximum of 15% of the total number of productive labor hours.
- (5) Cost of use of special equipment shall be paid when justified in the opinion of the County, and approved by the County. Equipment refers to special equipment that is needed to perform that specific job, and does not include the usual tools customarily required for that trade. Small tools costs are not paid by County.
- (6) Material transportation costs are paid by County when justified in the opinion of the County, and approved by the County's authorized representative.
- (7) Overhead, profit and fees on subcontracts, are paid according to the contract.
- (8) No costs other than those designated above shall be paid by County. The percentages of overhead and fee allowed with change orders have been established to account for any other direct or indirect costs that might be incurred due to the change order.

19.3 AUDIT

19.3.1 The County shall have the right to examine and audit all books, estimates, records, contracts, documents, bid documents, subcontracts, and other data of the Contractor (including computations and projections) related to negotiating, pricing, or performing the modification in order to evaluate the accuracy and completeness of the cost or pricing data at no additional cost to the County.

19.3.2 The Contractor shall make available at its office at all reasonable times the materials described in paragraph

19.3.1 above, for examination, audit, or reproduction, until 4 years after final payment under this Contract.

19.3.3 The Contractor shall insert a clause containing all the provisions of this 19.3, including this paragraph, in all subcontracts over \$10,000 under this contract.

ARTICLE 20 PAYMENT

20.1 PROGRESS PAYMENTS

20.1.1 The County shall pay the Contractor the price as provided in this Contract.

20.1.2 The County shall make progress payments monthly as the Work proceeds, on estimates approved by the County. The Contractor shall furnish a breakdown of the total contract price, in a format provided by the County, showing the amount included therein for each principal category of the work, in such detail as requested, to provide a basis for determining progress payments.

20.1.3 Contractor shall submit to the County vouchers, schedule activities, or other satisfactory proof of the value of any work for which he claims payment on such account, and receipts showing that progress payments have been duly made on such contracts, and for materials furnished.

20.1.4 In the preparation of estimates, the County may authorize 75% of the value of material delivered and satisfactorily stored on the site, and preparatory work done to be taken into consideration for major equipment if:

- a. Consideration is specifically authorized by this Contract; and
- b. The Contractor furnishes certified receipt that it has acquired title and paid invoices for such material and that the material will be used to perform this Contract.

20.1.5 On the 25th of each month the Contractor will submit his request for payment. Prior to that submittal the County will review the requested percentage of completion for each activity. The payment request will be in the format as provided by the County and will refer to the schedule.

20.1.6 Upon receipt of a payment request, the County shall:

- a. Review that request as soon as practicable after receipt for the purpose of determining that the payment request is a proper payment request; and
- b. Any payment request determined not to be a proper request suitable for payment shall be returned to the Contractor as soon as practicable, but not later than seven (7) calendar days after receipt. The returned request for payment shall be accompanied by a document setting forth in writing the reasons why the payment request is not proper.

20.1.7 Any progress payment which is undisputed and properly submitted and remains unpaid for thirty (30) calendar days after receipt by County shall accrue interest to the Contractor equivalent to the legal rate set forth in subdivision (a) of Section 685.010 of the California Code of Civil Procedure. The number of days available to the County to make a payment without incurring interest pursuant to this section shall be reduced by the number of days by which the County exceeds the seven-day return requirement set forth in 20.1.6 above.

20.1.8 In making these progress payments, there shall be retained ten percent (10%) from the amount of each

progress payment until the work is 50% complete. After the 50% completion point, if satisfactory progress is being made and at the sole discretion of the County, the retention may be reduced to a minimum of 5% of the contract.

20.1.9 Except as otherwise prohibited by law, the Contractor may elect to receive all payments due under the contract pursuant to this section without any retention, by posting securities in accordance with Public Contract Code Section 22300.

20.1.10 Contractor and each subcontractor shall pay each of its employees engaged in work under this Contract in full (less deductions made mandatory by law) in accordance with California law.

20.1.11 The County may withhold (in excess of retentions) or, on account of subsequently discovered evidence, nullify the whole or a part of any certificate to such extent as may be necessary to protect the County from loss on account of:

- a. Defective work not remedied.
- b. Claims filed or reasonable evidence indicating probable filing of claims.
- c. Failure of the Contractor to make payments properly to subcontractors or for material or labor.
- d. Damage to another Contractor.
- e. Delays in progress toward completion of the work, with the stipulated amount of liquidated damages being withheld for each day of delay for which no extension is granted.
- f. Default of the Contractor in the performance of the terms of the Contract.

20.1.12 Should stop notices be filed with the County, County shall withhold the amount required plus 25% from certificates until such claims shall have been resolved pursuant to applicable law. California Civil Code Section 3179 et seq.

20.1.13 At the election of the County, Contractor shall provide, within ten (10) calendar days of receipt of each progress payment, unconditional waivers and release of lien rights, signed by Contractor and each of its subcontractors and materials suppliers, in the form established therefore by Section 3262 of the Civil Code.

20.1.14 All material and work covered by progress payments made shall, at the time of payment, become the sole property of the County, but this shall not be construed as:

- a. An acceptance of any work not in accordance with the Contract Documents; or
- b. Waiving the right of the County to require the fulfillment of all of the terms of the contract.

20.2 FINAL PAYMENT

20.2.1 GENERAL

- a. The County shall pay the amount due the Contractor under this Contract after:

- 1.) The Acceptance of all work and Notice of Completion per the terms of this Contract;
 - 2.) Presentation of a properly executed voucher;
 - 3.) Release of all liens and Stop Notices; and
 - 4.) Presentation of release of all claims against the County arising by virtue of this Contract, other than claims and disputes in stated amounts, that the Contractor has specifically excepted from the operation of the release.
- b. The Contractor may, if any subcontractor refuses to furnish a release or receipt in full, furnish a bond satisfactory to the County, to indemnify him against any lien.

20.2.2 FINAL CERTIFICATE FOR PAYMENT

- a. When the work is ready for acceptance by the County, the Economic Development Agency will certify and submit to the Board of Supervisors a Notice of Completion. Upon approval of the Notice of Completion, a copy will be sent to the Contractor.
- b. Notice of Completion will be recorded by the County upon completion and Acceptance of the Work. Providing no stop notices have been filed, thirty-five (35) calendar days after filing of such Notice of Completion, payment due under the contract will become due to the Contractor and the County shall so certify authorizing the final payment.

20.2.3 FINAL PAYMENT

- a. After Acceptance of Work, the County will submit to Contractor a statement of the sum due Contractor under this contract, together with County payment in the amount thereof. Said statement shall take into account the contract price, as adjusted by any change orders; amounts already paid; sums to be withheld for incomplete work; liquidated damages; and for any other cause under the Contract.
- b. The Contractor shall, from the effective date of Acceptance until the expiration of four years after final settlement under this Contract, preserve and make available to the County, all its books, records, documents, and other evidence bearing on the costs and expenses of the Contractor under this Contract.

ARTICLE 21 SUSPENSION OF WORK/TERMINATION

21.1 NON-COMPLIANCE WITH CONTRACT REQUIREMENTS

21.1.1 In the event the Contractor, after receiving written notice from the County of non-compliance with any requirement of this Contract, fails to promptly initiate appropriate action to comply with the specified requirement, the County shall have the right to withhold payment for work completed under the Contract until the Contractor has complied with the notice or has initiated such action as may be appropriate to comply, within a reasonable period of time. The Contractor shall not be entitled to any extension of contract time or payment for any costs incurred for work under this article.

21.1.2 Should the Contractor abandon the Work called for under the Contract, or assign his Contract, or unnecessarily and unreasonably delay the work, or willfully violate or perform the work in bad faith, the

County shall have the power to notify the Contractor to discontinue all work or any part thereof under this Contract, and thereupon the Contractor shall cease to continue said work or such part thereof as the County may designate, and the County shall have the power to employ such persons as it may consider desirable, and to obtain by contract, purchase, hire or otherwise, such implements, tools, material or materials as the County may deem advisable to work at and be used to complete the work herein described, or such part thereof as shall have not been completed, and to use such material as it may find upon the site of the work, and to charge the expense of such labor and material, implements and tools to the Contractor, and the expense so charged shall be deducted and paid by the County out of such monies as may either be due, or may at any time thereafter become due to the Contractor under the Contract.

21.2 TERMINATION

21.2.1 TERMINATION FOR BREACH

If the Contractor should be adjudged bankrupt or if he should make a general assignment for the benefit of his creditors, or if a receiver should be appointed on account of his insolvency, or if he or any of his subcontractors should violate any of the provisions of the Contract, the County may serve written notice upon him and his surety of its intention to terminate Contractor's performance hereunder, said notice shall contain the reasons for such intention to terminate Contractor's performance, and, unless within ten (10) calendar days after serving of said notice, such violation shall cease and satisfactory arrangements for correction thereof be made, Contractor's performance shall, upon the expiration of said ten (10) calendar days, cease and terminate. In the event of any such termination, the County shall immediately serve written notice thereof upon the surety and the Contractor, and the County may take over the Contractor's work and prosecute the same to completion by contract or by any other method it may deem advisable, for the account and at the expense of the Contractor, and the Contractor and his surety shall be liable to the County for any excess cost occasioned the County thereby, and in such event the County may without liability for so doing take possession of and utilize in completing the work, such materials, appliances, plants, and other property belonging to the Contractor as may be on the site of the work and necessary therefore.

21.2.2 TERMINATION FOR CONVENIENCE

- a. If the construction of the project herein is damaged, which damage is determined to have been proximately caused by an Act of God, in excess of 5% of the contract amount, provided that the work damaged is built in accordance with applicable building standards and the plans and specifications, then the County may, without prejudice to any other right or remedy, terminate the Contract.
- b. The County may terminate performance of work under this Contract in whole or in part, if the County determines that a termination is in the County's interest. The County shall terminate by delivering to the Contractor a Notice to Terminate specifying the extent of termination and the effective date.
- c. After receipt of such Notice, and except as directed by the County, the Contractor shall immediately proceed with the following obligations, regardless of any delay in determining or adjusting any amounts due under this clause:
 - (1) Stop work as specified in the notice.
 - (2) Place no further subcontracts or orders (referred to as subcontracts in this clause) for materials, services, or facilities, except as necessary to complete any continued portion of the Contract.

- (3) To terminate all subcontracts to the extent they relate to the work terminated.
 - (4) With approval or ratification to the extent required by the County, settle all outstanding liabilities and termination settlement proposals arising from termination of subcontracts; the approval or ratification will be final for purposes of this clause.
 - (5) As directed by the County, transfer title and deliver to the County (1) the fabricated or unfabricated parts; work in progress, completed work, supplies, and other material produced or acquired for the work terminated; and (2) the completed or partially completed plans, drawings, information, and other property that, if the contract had been completed, would be required to be furnished to the County.
 - (6) Complete performance of work not terminated.
 - (7) Take any action that may be necessary, or that the County may direct, for the protection and preservation of the property related to this contract that is in the possession of the Contractor and in which the County has or may acquire an interest.
 - (8) Use its best efforts to sell, as directed or authorized by the County, any property of the types referred to in subparagraphs above; provided, however, that the Contractor (1) is not required to extend credit to any purchaser and (2) may acquire the property under the conditions prescribed by, and at prices approved by the County. The proceeds of any transfer or disposition will be applied to reduce any payments to be made by the County under this contract, credited to the price or cost of the work, or paid in any other manner directed by the County.
- d. After termination, the Contractor shall submit a final termination settlement proposal to the County in the form and with the certification prescribed by the County. The Contractor shall submit the proposal promptly, but no later than thirty (30) days from the effective date of termination. If the Contractor fails to submit the proposal within the time allowed, the County may determine, on the basis of information available, the amount, if any, due the Contractor because of the termination and shall pay the amount determined.
- e. Subject to subparagraph (2) above, the Contractor and the County may agree upon the whole or any part of the amount to be paid because of the termination. The amount may include a reasonable allowance for profit on work done. However, the agreed amount, may not exceed the total contract price as reduced by:
- (1) the amount of payments previously made and;
 - (2) the contract price of work not terminated. The contract shall be amended with a Change Order, and the Contractor paid the agreed amount.
- f. If the Contractor and County fail to agree on the whole amount to be paid the Contractor because of the termination of work, the County shall pay the Contractor the amounts determined as follows:

- (1) For contract work performed before the effective date of termination, the total (without duplication of any terms) of:
 - (i) The cost of this work;
 - (ii) The cost of settling and paying termination settlement proposals under terminated subcontracts that are properly chargeable to the terminated portion of the contract if not included in subdivision (i) above; and
 - (iii) A sum, as profit on (i) above, determined by the County to be fair and reasonable; however, if it appears that the Contractor would have sustained a loss on the entire contract had it been completed, the County shall allow no profit under this subdivision (iii).
- (2) The reasonable costs of settlement of the work terminated including:
 - (i) Accounting, clerical, and other expenses reasonably necessary for the preparation of termination settlement proposals and supporting data; and
 - (ii) Storage, transportation, and other costs incurred, reasonably necessary for the preservation, protection, or disposition of the termination inventory.
- g. Except for normal spoilage, the County shall exclude from the amounts payable to the Contractor the fair value, as determined by the County, of defective work, and of property that is destroyed, lost, stolen, or damaged so as to become undeliverable.
- h. The Contractor shall have the right to make a claim under the DISPUTES article, from any determination made by the County.
- i. In arriving at the amount due the Contractor, there shall be deducted:
 - (1) All unliquidated advance or other payments to the Contractor under the terminated portion of this Contract;
 - (2) Any claim which the County has against the Contractor under this Contract; and
 - (3) The agreed price for, or the proceeds of sale of, materials, supplies, or other things acquired by the Contractor or sold under the provisions of this clause and not recovered by or credited to the County.
- j. If the termination is partial, the Contractor may file a proposal with the County for a Change Order of the price(s) of the continued portion of the Contract. The County shall process any Change Order agreed upon. Any proposal by the Contractor for an equitable adjustment under this clause shall be requested within thirty (30) days from the effective date of termination unless extended in writing by the County.
- k. The County may, under the terms and conditions it prescribes, make partial payments and payments against costs incurred by the Contractor for the terminated portion of the Contract, if the County believes the total of these payments will not exceed the amount to which the Contractor will be entitled. If the total payments exceed the amount finally determined to be due, the Contractor shall repay the excess to the County upon demand, together with interest.

1. Unless otherwise provided in this Contract or by statute, the Contractor will maintain all records and documents relating to the terminated portion of this Contract for 4 years after final settlement. This includes all books and other evidence bearing on the Contractor's costs and expenses under this Contract. The Contractor shall make these records and documents available to the County, State and/or the U.S. Government or their representatives at all reasonable times, without any direct charge.

ARTICLE 22 DISPUTES/CLAIMS

22.1 CLAIMS RESOLUTION

In accordance with Public Contract Code Sections 20104 20104.6 and other applicable law, public works claims of \$375,000 or less which arise between the Contractor and the Owner shall be resolved under the following the statutory procedure unless the Owner has elected to resolve the dispute pursuant to Public Contract Code Section 10240 et seq.

- a. All claims shall be submitted in writing and accompanied by substantiating documentation. Claims must be filed on or before the date of final payment unless other notice requirements are provided in the contract. "Claim" means a separate demand by the claimant for (1) a time extension, (2) payment of money or damages arising from work done by or on behalf of the claimant and payment of which is not otherwise expressly provided for or the claimant is not otherwise entitled, or (3) an amount the payment of which is disputed by the Owner.
- b. Claims Under \$50,000. The Owner shall respond in writing to the claim within 45 days of receipt of the claim, or, the Owner may request, in writing, within 30 days of receipt of the claim, any additional documentation supporting the claim or relating to defenses or claims the Owner may have. Of additional information is needed thereafter, it shall be provided upon mutual agreement of the Owner and the claimant. The Owner's written response shall be submitted 15 days after receiving the additional documentation, or within the same period of time taken by the claimant to produce the additional information, whichever is greater.
- c. Claims over \$50,000 but less than or equal to \$375,000. The Owner shall respond in writing within 60 days of receipt, or, may request in writing within 30 days of receipt of the claim, any additional documents supporting the claim or relating to defenses or claims the Owner may have against the claimant. If additional information is needed thereafter, it shall be provided pursuant to mutual agreement between the Owner and the claimant. The Owner's response shall be submitted within 30 days after receipt of the further documents, or within the same period of time taken by the claimant to produce the additional information or documents, whichever is greater. The Contractor shall make these records and documents available to the County, State and/or the U.S. Government or their representatives at all reasonable times, without any direct charge.
- d. If the claimant disputes the Owner's response, or if the Owner fails to respond within the statutory time period(s), the claimant may so notify the Owner within 15 days of the receipt of the response or the failure to respond, and demand an informal conference to meet and confer for settlement. Upon such demand, the Owner shall schedule a meet and confer conference within 30 days.

- e. If following the meet and confer conference, the claim or any portion thereof remains in dispute, the claimant may file a claim pursuant to Government Code 900 et seq. and Government Code 910 et seq. For purposes of those provisions, the time within which a claim must be filed shall be tolled from the time the claimant submits the written claim until the time the claim is denied, including any time utilized for the meet and confer conference.
- f. If a civil action is filed to resolve any claim, the provisions of Public Contract Code 20104.4 shall be followed, providing for nonbinding mediation and judicial arbitration.

22.2 CLAIM FORMAT/REQUIREMENTS

22.2.1 The Contractor will submit the claim justification in the following format:

- a. Summary of claim merit and price plus clause under which the claim is made.
- b. List of documents relating to claim
 - (a) Specifications
 - (b) Drawings
 - (c) Clarifications (RFIS)
 - (d) Schedules
 - (e) Other
- c. Chronology of events and correspondence
- d. Analysis of claim merit
- e. Analysis of claim cost
- f. Analysis of Time in CPM format
- g. Cover letter and certification (form included herein)

22.2.2 If any claim submitted includes a request for overhead, the County may request a Profit & Loss statement and supporting documentation from Contractor. If requested, such documentation must be submitted for the County to consider the claim.

22.2.3 Submission of a claim, properly certified, with all required supporting documentation, and written rejection or denial of all or part of the claim by County, is a condition precedent to any action, proceeding, litigation, suit, general conditions claim, or demand for arbitration by Contractor.

22.3 NOTICE OF THIRD PARTY CLAIMS

The County shall provide notification to the Contractor within a reasonable time after receipt of any third-party claim relating to the Construction Contract.



Revision Number	Description	Date
01	CONTRACT DOCUMENTS	01/11/2025
02	CONTRACT DOCUMENTS	01/11/2025

Checked	Approved	Date	Scale
			NO SCALE

**GENERAL NOTES,
 LEGEND, SHEET
 INDEX AND SINGLE
 LINE DIAGRAM**

GENERAL NOTES

1. VERIFY THAT ALL WORK IS IN ACCORDANCE WITH THE CURRENT EDITIONS OF THE NATIONAL ELECTRICAL CODE (NEC) AND ALL OTHER APPLICABLE FEDERAL, STATE AND LOCAL CODES. THE CONTRACTOR SHALL BE RESPONSIBLE FOR OBTAINING ALL NECESSARY PERMITS AND APPROVALS FROM THE APPLICABLE AGENCIES. THE CONTRACTOR SHALL BE RESPONSIBLE FOR OBTAINING ALL NECESSARY PERMITS AND APPROVALS FROM THE APPLICABLE AGENCIES.
2. IN THE EVENT OF A CONFLICT OR INCONSISTENCY BETWEEN ITEMS PROVIDED ON THIS DRAWING AND ANY APPLICABLE CODES, THE CONTRACTOR SHALL CONSULT WITH THE ARCHITECT AND THE ENGINEER TO RESOLVE ANY DISCREPANCIES.
3. WORK SHALL BE COMPLETED WITHIN THE SPECIFIED TIME FRAME AND IN ACCORDANCE WITH THE SCHEDULE. THE CONTRACTOR SHALL BE RESPONSIBLE FOR OBTAINING ALL NECESSARY PERMITS AND APPROVALS FROM THE APPLICABLE AGENCIES.
4. THE CONTRACTOR SHALL CHECK ALL WORKMANSHIP AND MATERIALS TO BE INSTALLED TO BE IN ACCORDANCE WITH THE CURRENT EDITIONS OF THE NATIONAL ELECTRICAL CODE (NEC) AND ALL OTHER APPLICABLE FEDERAL, STATE AND LOCAL CODES. THE CONTRACTOR SHALL BE RESPONSIBLE FOR OBTAINING ALL NECESSARY PERMITS AND APPROVALS FROM THE APPLICABLE AGENCIES.
5. ALL MATERIALS AND EQUIPMENT SHALL BE NEW UNLESS OTHERWISE SPECIFIED AND SHALL BE INSTALLED IN ACCORDANCE WITH THE CURRENT EDITIONS OF THE NATIONAL ELECTRICAL CODE (NEC) AND ALL OTHER APPLICABLE FEDERAL, STATE AND LOCAL CODES. THE CONTRACTOR SHALL BE RESPONSIBLE FOR OBTAINING ALL NECESSARY PERMITS AND APPROVALS FROM THE APPLICABLE AGENCIES.
6. THE CONTRACTOR SHALL NOT BE RESPONSIBLE FOR THE DESIGN OF ANY STRUCTURAL WORK. ANY STRUCTURAL WORK SHALL BE DESIGNED BY A LICENSED PROFESSIONAL ENGINEER IN STRUCTURAL ENGINEERING AND SHALL BE IN ACCORDANCE WITH THE CURRENT EDITIONS OF THE NATIONAL ELECTRICAL CODE (NEC) AND ALL OTHER APPLICABLE FEDERAL, STATE AND LOCAL CODES. THE CONTRACTOR SHALL BE RESPONSIBLE FOR OBTAINING ALL NECESSARY PERMITS AND APPROVALS FROM THE APPLICABLE AGENCIES.
7. ALL CONDUIT SHALL BE INSTALLED IN ACCORDANCE WITH THE CURRENT EDITIONS OF THE NATIONAL ELECTRICAL CODE (NEC) AND ALL OTHER APPLICABLE FEDERAL, STATE AND LOCAL CODES. THE CONTRACTOR SHALL BE RESPONSIBLE FOR OBTAINING ALL NECESSARY PERMITS AND APPROVALS FROM THE APPLICABLE AGENCIES.
8. WORKING HEIGHTS OF LADDER AND SCAFFOLDING SHALL BE LIMITED TO 10 FEET UNLESS OTHERWISE SPECIFIED. THE CONTRACTOR SHALL BE RESPONSIBLE FOR OBTAINING ALL NECESSARY PERMITS AND APPROVALS FROM THE APPLICABLE AGENCIES.
9. THE CONTRACTOR SHALL MAINTAIN CLEAR ACCESS TO ALL EXISTING UTILITIES AND SHALL BE RESPONSIBLE FOR OBTAINING ALL NECESSARY PERMITS AND APPROVALS FROM THE APPLICABLE AGENCIES.
10. THE CONTRACTOR SHALL MAINTAIN CLEAR ACCESS TO ALL EXISTING UTILITIES AND SHALL BE RESPONSIBLE FOR OBTAINING ALL NECESSARY PERMITS AND APPROVALS FROM THE APPLICABLE AGENCIES.
11. THE CONTRACTOR SHALL MAINTAIN CLEAR ACCESS TO ALL EXISTING UTILITIES AND SHALL BE RESPONSIBLE FOR OBTAINING ALL NECESSARY PERMITS AND APPROVALS FROM THE APPLICABLE AGENCIES.
12. ALL WORK SHALL BE COMPLETED WITHIN THE SPECIFIED TIME FRAME AND IN ACCORDANCE WITH THE SCHEDULE. THE CONTRACTOR SHALL BE RESPONSIBLE FOR OBTAINING ALL NECESSARY PERMITS AND APPROVALS FROM THE APPLICABLE AGENCIES.
13. DEVELOPMENT (NOTES)

SHEET INDEX

- 01 GENERAL NOTES
- 02 SECURITY POWER PLAN

SYMBOL AND CONDUIT LEGEND

SYMBOL	DESCRIPTION
[Symbol]	24" FLOOR/CEILING LIGHT FIXTURE
[Symbol]	24" FLOOR/CEILING LIGHT FIXTURE (RECESSED)
[Symbol]	24" FLOOR/CEILING LIGHT FIXTURE (RECESSED) - 2' x 4'
[Symbol]	24" FLOOR/CEILING LIGHT FIXTURE (RECESSED) - 2' x 4' - 2' x 4'
[Symbol]	24" FLOOR/CEILING LIGHT FIXTURE (RECESSED) - 2' x 4' - 2' x 4' - 2' x 4'
[Symbol]	24" FLOOR/CEILING LIGHT FIXTURE (RECESSED) - 2' x 4' - 2' x 4' - 2' x 4' - 2' x 4'
[Symbol]	24" FLOOR/CEILING LIGHT FIXTURE (RECESSED) - 2' x 4' - 2' x 4' - 2' x 4' - 2' x 4' - 2' x 4'

LOAD SUMMARY 'EM'

UNUSUAL PEAK DEMAND	100 AMPS
AT 400V	25.00A

LOAD SUMMARY 'EL'

UNUSUAL PEAK DEMAND	150 AMPS
AT 400V	37.50A

LOAD SUMMARY 'ELP'

UNUSUAL PEAK DEMAND	41 AMPS
AT 400V	10.25A

SINGLE LINE DIAGRAM

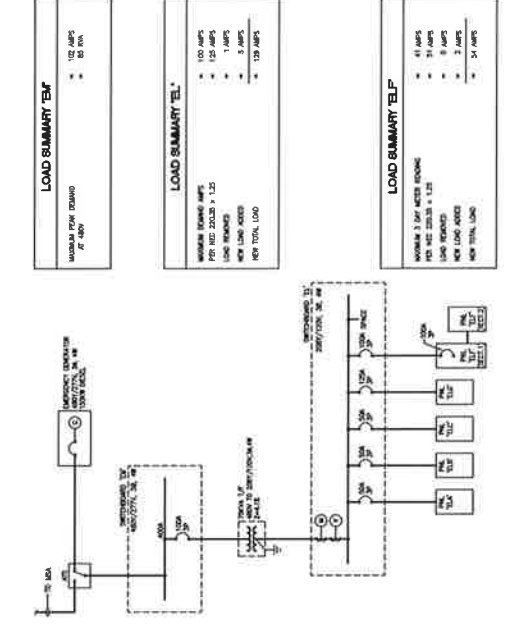

NOTE ALL EQUIPMENT IS EXISTING

LEGEND

SINGLE LINE DIAGRAM LEGEND

SYMBOL	DESCRIPTION
[Symbol]	24" FLOOR/CEILING LIGHT FIXTURE
[Symbol]	24" FLOOR/CEILING LIGHT FIXTURE (RECESSED)
[Symbol]	24" FLOOR/CEILING LIGHT FIXTURE (RECESSED) - 2' x 4'
[Symbol]	24" FLOOR/CEILING LIGHT FIXTURE (RECESSED) - 2' x 4' - 2' x 4'
[Symbol]	24" FLOOR/CEILING LIGHT FIXTURE (RECESSED) - 2' x 4' - 2' x 4' - 2' x 4'
[Symbol]	24" FLOOR/CEILING LIGHT FIXTURE (RECESSED) - 2' x 4' - 2' x 4' - 2' x 4' - 2' x 4'

POWER LEGEND

SYMBOL	DESCRIPTION
[Symbol]	24" FLOOR/CEILING LIGHT FIXTURE
[Symbol]	24" FLOOR/CEILING LIGHT FIXTURE (RECESSED)
[Symbol]	24" FLOOR/CEILING LIGHT FIXTURE (RECESSED) - 2' x 4'
[Symbol]	24" FLOOR/CEILING LIGHT FIXTURE (RECESSED) - 2' x 4' - 2' x 4'
[Symbol]	24" FLOOR/CEILING LIGHT FIXTURE (RECESSED) - 2' x 4' - 2' x 4' - 2' x 4'
[Symbol]	24" FLOOR/CEILING LIGHT FIXTURE (RECESSED) - 2' x 4' - 2' x 4' - 2' x 4' - 2' x 4'

CONDUIT PENETRATION DETAILS

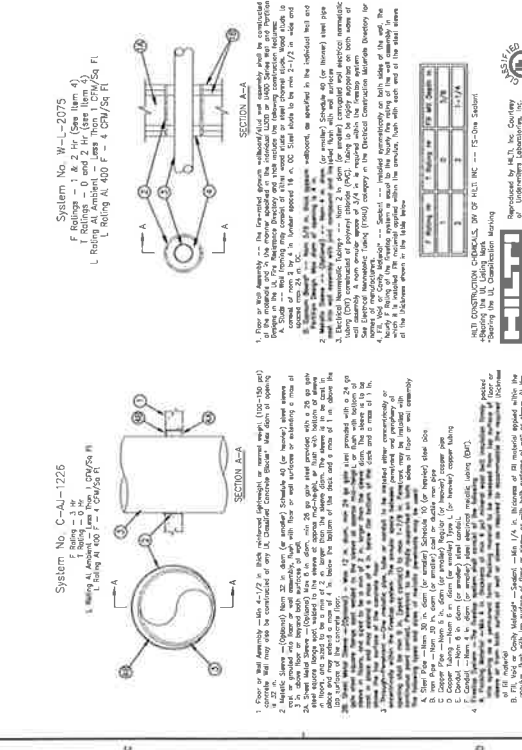

NOTE ALL EQUIPMENT IS EXISTING



Revision	Description	Date
1	ORIGIN	11/15/11
2	REVISION	
3	REVISION	
4	REVISION	
5	REVISION	
6	REVISION	
7	REVISION	
8	REVISION	
9	REVISION	
10	REVISION	

Prepared	by	J
Checked	by	
Approved	by	
Date	11/15/11	
Scale	AS SHOWN	
Sheet No.	020180001111111	
Book	3322-11-7	
Sheet Title		



KEY NOTES

1. SECURITY CAMERA MONITORING CENTERS WILL BE LOCATED IN THE CENTRAL CORRIDOR. SECURITY EQUIPMENT SHALL BE INSTALLED IN THE CENTRAL CORRIDOR. SECURITY EQUIPMENT SHALL BE INSTALLED IN THE CENTRAL CORRIDOR.
2. SECURITY CAMERA MONITORING CENTERS WILL BE LOCATED IN THE CENTRAL CORRIDOR. SECURITY EQUIPMENT SHALL BE INSTALLED IN THE CENTRAL CORRIDOR. SECURITY EQUIPMENT SHALL BE INSTALLED IN THE CENTRAL CORRIDOR.
3. ALL SECURITY EQUIPMENT SHALL BE INSTALLED IN THE CENTRAL CORRIDOR. SECURITY EQUIPMENT SHALL BE INSTALLED IN THE CENTRAL CORRIDOR. SECURITY EQUIPMENT SHALL BE INSTALLED IN THE CENTRAL CORRIDOR.

Room No.	Room Name	Camera Type	Qty	Notes
101	WARD A	IP	10	
102	WARD A	IP	10	
103	WARD A	IP	10	
104	WARD A	IP	10	
105	WARD A	IP	10	
106	WARD A	IP	10	
107	WARD A	IP	10	
108	WARD A	IP	10	
109	WARD A	IP	10	
110	WARD A	IP	10	
111	WARD A	IP	10	
112	WARD A	IP	10	
113	WARD A	IP	10	
114	WARD A	IP	10	
115	WARD A	IP	10	
116	WARD A	IP	10	
117	WARD A	IP	10	
118	WARD A	IP	10	
119	WARD A	IP	10	
120	WARD A	IP	10	
121	WARD A	IP	10	
122	WARD A	IP	10	
123	WARD A	IP	10	
124	WARD A	IP	10	
125	WARD A	IP	10	
126	WARD A	IP	10	
127	WARD A	IP	10	
128	WARD A	IP	10	
129	WARD A	IP	10	
130	WARD A	IP	10	
131	WARD A	IP	10	
132	WARD A	IP	10	
133	WARD A	IP	10	
134	WARD A	IP	10	
135	WARD A	IP	10	
136	WARD A	IP	10	
137	WARD A	IP	10	
138	WARD A	IP	10	
139	WARD A	IP	10	
140	WARD A	IP	10	
141	WARD A	IP	10	
142	WARD A	IP	10	
143	WARD A	IP	10	
144	WARD A	IP	10	
145	WARD A	IP	10	
146	WARD A	IP	10	
147	WARD A	IP	10	
148	WARD A	IP	10	
149	WARD A	IP	10	
150	WARD A	IP	10	
151	WARD A	IP	10	
152	WARD A	IP	10	
153	WARD A	IP	10	
154	WARD A	IP	10	
155	WARD A	IP	10	
156	WARD A	IP	10	
157	WARD A	IP	10	
158	WARD A	IP	10	
159	WARD A	IP	10	
160	WARD A	IP	10	
161	WARD A	IP	10	
162	WARD A	IP	10	
163	WARD A	IP	10	
164	WARD A	IP	10	
165	WARD A	IP	10	
166	WARD A	IP	10	
167	WARD A	IP	10	
168	WARD A	IP	10	
169	WARD A	IP	10	
170	WARD A	IP	10	
171	WARD A	IP	10	
172	WARD A	IP	10	
173	WARD A	IP	10	
174	WARD A	IP	10	
175	WARD A	IP	10	
176	WARD A	IP	10	
177	WARD A	IP	10	
178	WARD A	IP	10	
179	WARD A	IP	10	
180	WARD A	IP	10	
181	WARD A	IP	10	
182	WARD A	IP	10	
183	WARD A	IP	10	
184	WARD A	IP	10	
185	WARD A	IP	10	
186	WARD A	IP	10	
187	WARD A	IP	10	
188	WARD A	IP	10	
189	WARD A	IP	10	
190	WARD A	IP	10	
191	WARD A	IP	10	
192	WARD A	IP	10	
193	WARD A	IP	10	
194	WARD A	IP	10	
195	WARD A	IP	10	
196	WARD A	IP	10	
197	WARD A	IP	10	
198	WARD A	IP	10	
199	WARD A	IP	10	
200	WARD A	IP	10	

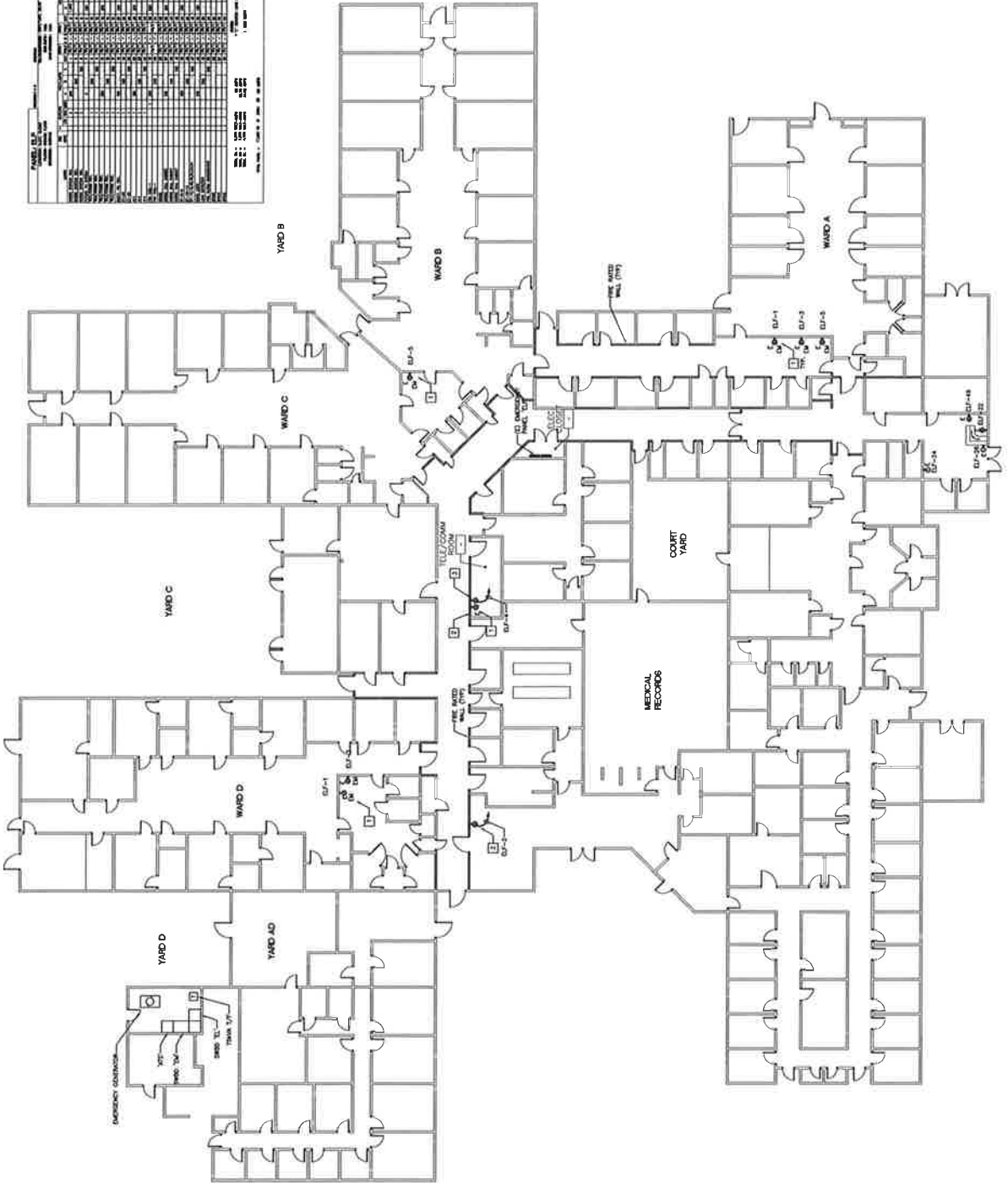



MENTAL HEALTH FACILITY
SECURITY CAMERA
REPLACEMENT
COUNTY OF RIVERSIDE



DESIGNED BY: P2S ENGINEERING, INC.
REVISED BY: P2S ENGINEERING, INC.



Project:	Security Camera Replacement
Client:	County of Riverside
Date:	09/23/15
Scale:	AS SHOWN
Drawn By:	STEVEN R. RAPP
Checked By:	
Reviewed By:	
Approved By:	
Sheet No.:	SEC-01
Sheet Total:	02

GENERAL NOTES,
SYMBOLS, AND
ABBREVIATIONS

<h3>SECURITY ELECTRONICS SYMBOL LEGEND</h3> <table border="1"> <tr><th>SYMBOL</th><th>DESCRIPTION</th><th>TYPE</th><th>MARKING</th></tr> <tr><td>○</td><td>VIDEO SURVEILLANCE (CCTV) SYSTEM</td><td></td><td></td></tr> <tr><td>□</td><td>VIDEO CAMERA</td><td></td><td></td></tr> <tr><td>■</td><td>VIDEO CAMERA MOUNT</td><td></td><td></td></tr> <tr><td>○</td><td>VIDEO CAMERA MOUNT BRACKET</td><td></td><td></td></tr> <tr><td>○</td><td>VIDEO CAMERA MOUNT BRACKET</td><td></td><td></td></tr> <tr><td>○</td><td>VIDEO CAMERA MOUNT BRACKET</td><td></td><td></td></tr> </table>	SYMBOL	DESCRIPTION	TYPE	MARKING	○	VIDEO SURVEILLANCE (CCTV) SYSTEM			□	VIDEO CAMERA			■	VIDEO CAMERA MOUNT			○	VIDEO CAMERA MOUNT BRACKET			○	VIDEO CAMERA MOUNT BRACKET			○	VIDEO CAMERA MOUNT BRACKET			<h3>SHEET INDEX</h3> <p>SEC-01 GENERAL NOTES, SYMBOLS, AND SHEET INDEX SEC-02 MENTAL HEALTH FACILITY SEC-03 MENTAL HEALTH FACILITY</p>	<h3>PROJECT NOTES</h3> <ol style="list-style-type: none"> VERIFY REQUIREMENTS FOR THE PROJECT. CHECK THE EXISTING WORK FOR ANY DEFICIENCIES. THE CONTRACTOR SHALL VERIFY THE EXISTING WORK IS AS SHOWN ON THE DRAWINGS. THE CONTRACTOR SHALL VERIFY THE EXISTING WORK IS AS SHOWN ON THE DRAWINGS. THE CONTRACTOR SHALL VERIFY THE EXISTING WORK IS AS SHOWN ON THE DRAWINGS. CONTRACTOR SHALL VERIFY THE EXISTING WORK IS AS SHOWN ON THE DRAWINGS. THE CONTRACTOR SHALL VERIFY THE EXISTING WORK IS AS SHOWN ON THE DRAWINGS. THE CONTRACTOR SHALL VERIFY THE EXISTING WORK IS AS SHOWN ON THE DRAWINGS. CONTRACTOR SHALL VERIFY THE EXISTING WORK IS AS SHOWN ON THE DRAWINGS. THE CONTRACTOR SHALL VERIFY THE EXISTING WORK IS AS SHOWN ON THE DRAWINGS. THE CONTRACTOR SHALL VERIFY THE EXISTING WORK IS AS SHOWN ON THE DRAWINGS. 	<h3>GENERAL NOTES</h3> <ol style="list-style-type: none"> THESE DRAWINGS PROVIDE INFORMATION NECESSARY FOR THE INSTALLATION OF THE SYSTEM. THE CONTRACTOR SHALL VERIFY THE EXISTING WORK IS AS SHOWN ON THE DRAWINGS. THE CONTRACTOR SHALL VERIFY THE EXISTING WORK IS AS SHOWN ON THE DRAWINGS. THE CONTRACTOR SHALL VERIFY THE EXISTING WORK IS AS SHOWN ON THE DRAWINGS. THESE DRAWINGS SHALL NOT BE USED FOR ANY OTHER PURPOSES. THE CONTRACTOR SHALL VERIFY THE EXISTING WORK IS AS SHOWN ON THE DRAWINGS. THE CONTRACTOR SHALL VERIFY THE EXISTING WORK IS AS SHOWN ON THE DRAWINGS. THE CONTRACTOR SHALL VERIFY THE EXISTING WORK IS AS SHOWN ON THE DRAWINGS. THE CONTRACTOR SHALL VERIFY THE EXISTING WORK IS AS SHOWN ON THE DRAWINGS. THE CONTRACTOR SHALL VERIFY THE EXISTING WORK IS AS SHOWN ON THE DRAWINGS. THE CONTRACTOR SHALL VERIFY THE EXISTING WORK IS AS SHOWN ON THE DRAWINGS. 	<h3>PATHWAY/ELECTRICAL NOTES</h3> <ol style="list-style-type: none"> CONTRACTOR SHALL VERIFY THE EXISTING WORK IS AS SHOWN ON THE DRAWINGS. THE CONTRACTOR SHALL VERIFY THE EXISTING WORK IS AS SHOWN ON THE DRAWINGS. THE CONTRACTOR SHALL VERIFY THE EXISTING WORK IS AS SHOWN ON THE DRAWINGS. CONTRACTOR SHALL VERIFY THE EXISTING WORK IS AS SHOWN ON THE DRAWINGS. THE CONTRACTOR SHALL VERIFY THE EXISTING WORK IS AS SHOWN ON THE DRAWINGS. THE CONTRACTOR SHALL VERIFY THE EXISTING WORK IS AS SHOWN ON THE DRAWINGS. CONTRACTOR SHALL VERIFY THE EXISTING WORK IS AS SHOWN ON THE DRAWINGS. THE CONTRACTOR SHALL VERIFY THE EXISTING WORK IS AS SHOWN ON THE DRAWINGS. THE CONTRACTOR SHALL VERIFY THE EXISTING WORK IS AS SHOWN ON THE DRAWINGS. 	<h3>ABBREVIATIONS</h3> <p>BA - BATTERY ALARM CA - CABLE ALARM ... (Other abbreviations follow)</p>	<h3>LEGEND NOTES</h3> <p>THESE NOTES... ... (Other legend notes follow)</p>
SYMBOL	DESCRIPTION	TYPE	MARKING																															
○	VIDEO SURVEILLANCE (CCTV) SYSTEM																																	
□	VIDEO CAMERA																																	
■	VIDEO CAMERA MOUNT																																	
○	VIDEO CAMERA MOUNT BRACKET																																	
○	VIDEO CAMERA MOUNT BRACKET																																	
○	VIDEO CAMERA MOUNT BRACKET																																	

P2S Engineering, Inc.
1000 East Santa Ana, 4th Floor
Tustin, CA 92680
Tel: 714.944.1222
www.p2sengineering.com



MENTAL HEALTH FACILITY
SECURITY CAMERA
REPLACEMENT

COUNTY OF RIVERSIDE



2133 MISSION AVE AVENUE
RIVERSIDE, CA 92507



Revision	Description	Date
1	10/27/2018	10/27/2018

MENTAL HEALTH
FLOOR PLAN

Sheet Number SE1-01

- SECTION NOTES BY STUDY:**
1. ALL WORK SHALL BE IN ACCORDANCE WITH THE LATEST EDITIONS OF ALL APPLICABLE CODES AND REGULATIONS. ALL WORK SHALL BE COMPLETED WITHIN THE SPECIFIED TIME FRAME. THE CONTRACTOR SHALL BE RESPONSIBLE FOR OBTAINING ALL NECESSARY PERMITS AND SHALL INSTALL ALL WORK IN ACCORDANCE WITH ALL APPLICABLE CODES AND REGULATIONS. THE CONTRACTOR SHALL BE RESPONSIBLE FOR OBTAINING ALL NECESSARY PERMITS AND SHALL INSTALL ALL WORK IN ACCORDANCE WITH ALL APPLICABLE CODES AND REGULATIONS. THE CONTRACTOR SHALL BE RESPONSIBLE FOR OBTAINING ALL NECESSARY PERMITS AND SHALL INSTALL ALL WORK IN ACCORDANCE WITH ALL APPLICABLE CODES AND REGULATIONS.
 2. ALL WORK SHALL BE COMPLETED WITHIN THE SPECIFIED TIME FRAME. THE CONTRACTOR SHALL BE RESPONSIBLE FOR OBTAINING ALL NECESSARY PERMITS AND SHALL INSTALL ALL WORK IN ACCORDANCE WITH ALL APPLICABLE CODES AND REGULATIONS. THE CONTRACTOR SHALL BE RESPONSIBLE FOR OBTAINING ALL NECESSARY PERMITS AND SHALL INSTALL ALL WORK IN ACCORDANCE WITH ALL APPLICABLE CODES AND REGULATIONS.
 3. THE CONTRACTOR SHALL BE RESPONSIBLE FOR OBTAINING ALL NECESSARY PERMITS AND SHALL INSTALL ALL WORK IN ACCORDANCE WITH ALL APPLICABLE CODES AND REGULATIONS. THE CONTRACTOR SHALL BE RESPONSIBLE FOR OBTAINING ALL NECESSARY PERMITS AND SHALL INSTALL ALL WORK IN ACCORDANCE WITH ALL APPLICABLE CODES AND REGULATIONS.
 4. THE CONTRACTOR SHALL BE RESPONSIBLE FOR OBTAINING ALL NECESSARY PERMITS AND SHALL INSTALL ALL WORK IN ACCORDANCE WITH ALL APPLICABLE CODES AND REGULATIONS. THE CONTRACTOR SHALL BE RESPONSIBLE FOR OBTAINING ALL NECESSARY PERMITS AND SHALL INSTALL ALL WORK IN ACCORDANCE WITH ALL APPLICABLE CODES AND REGULATIONS.
- GENERAL NOTES:**
1. ALL CAMERA INSTALLATIONS SHALL BE IN ACCORDANCE WITH THE LATEST EDITIONS OF ALL APPLICABLE CODES AND REGULATIONS. THE CONTRACTOR SHALL BE RESPONSIBLE FOR OBTAINING ALL NECESSARY PERMITS AND SHALL INSTALL ALL WORK IN ACCORDANCE WITH ALL APPLICABLE CODES AND REGULATIONS. THE CONTRACTOR SHALL BE RESPONSIBLE FOR OBTAINING ALL NECESSARY PERMITS AND SHALL INSTALL ALL WORK IN ACCORDANCE WITH ALL APPLICABLE CODES AND REGULATIONS.
 2. THE CONTRACTOR SHALL BE RESPONSIBLE FOR OBTAINING ALL NECESSARY PERMITS AND SHALL INSTALL ALL WORK IN ACCORDANCE WITH ALL APPLICABLE CODES AND REGULATIONS. THE CONTRACTOR SHALL BE RESPONSIBLE FOR OBTAINING ALL NECESSARY PERMITS AND SHALL INSTALL ALL WORK IN ACCORDANCE WITH ALL APPLICABLE CODES AND REGULATIONS.
 3. THE CONTRACTOR SHALL BE RESPONSIBLE FOR OBTAINING ALL NECESSARY PERMITS AND SHALL INSTALL ALL WORK IN ACCORDANCE WITH ALL APPLICABLE CODES AND REGULATIONS. THE CONTRACTOR SHALL BE RESPONSIBLE FOR OBTAINING ALL NECESSARY PERMITS AND SHALL INSTALL ALL WORK IN ACCORDANCE WITH ALL APPLICABLE CODES AND REGULATIONS.
 4. THE CONTRACTOR SHALL BE RESPONSIBLE FOR OBTAINING ALL NECESSARY PERMITS AND SHALL INSTALL ALL WORK IN ACCORDANCE WITH ALL APPLICABLE CODES AND REGULATIONS. THE CONTRACTOR SHALL BE RESPONSIBLE FOR OBTAINING ALL NECESSARY PERMITS AND SHALL INSTALL ALL WORK IN ACCORDANCE WITH ALL APPLICABLE CODES AND REGULATIONS.

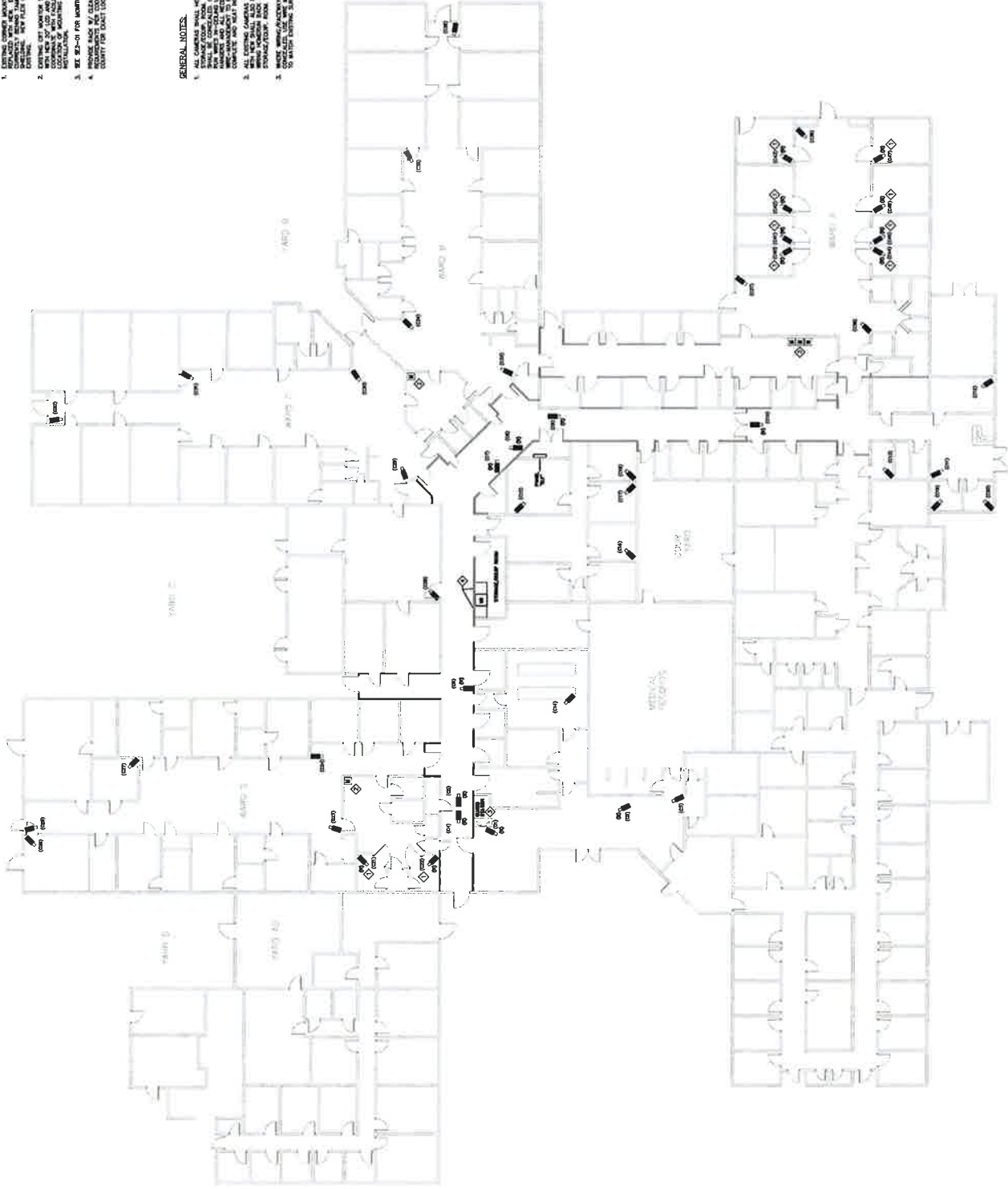



Project:	Security
Client:	AMS
Contract No.:	11-0000
Revision:	
Drawn:	BJ
Checked:	BJ
Date:	11/20/08
Sheet:	05-SECURITY
Scale:	NO SCALE

GENERAL NOTES:

- WORK OF ALL FIELD CONTRACTORS TO BE REPLACED WITH NEW, NEPA.
- WORK SHALL BE IN ACCORDANCE WITH ALL APPLICABLE CODES AND REGULATIONS. ALL WORK SHALL BE SUBJECT TO INSPECTION AND APPROVAL BY THE COUNTY OF RIVERSIDE. ALL WORK SHALL BE SUBJECT TO INSPECTION AND APPROVAL BY THE COUNTY OF RIVERSIDE. ALL WORK SHALL BE SUBJECT TO INSPECTION AND APPROVAL BY THE COUNTY OF RIVERSIDE.

CAMERA #	RECESS	WALL MOUNT	DIGITAL VIDEO RECORDING
1	1	1	YES
2	1	1	YES
3	1	1	YES
4	1	1	YES
5	1	1	YES
6	1	1	YES
7	1	1	YES
8	1	1	YES
9	1	1	YES
10	1	1	YES
11	1	1	YES
12	1	1	YES
13	1	1	YES
14	1	1	YES
15	1	1	YES
16	1	1	YES
17	1	1	YES
18	1	1	YES
19	1	1	YES
20	1	1	YES
21	1	1	YES
22	1	1	YES
23	1	1	YES
24	1	1	YES
25	1	1	YES
26	1	1	YES
27	1	1	YES
28	1	1	YES
29	1	1	YES
30	1	1	YES
31	1	1	YES
32	1	1	YES
33	1	1	YES
34	1	1	YES
35	1	1	YES
36	1	1	YES
37	1	1	YES
38	1	1	YES
39	1	1	YES
40	1	1	YES
41	1	1	YES
42	1	1	YES
43	1	1	YES
44	1	1	YES
45	1	1	YES
46	1	1	YES
47	1	1	YES

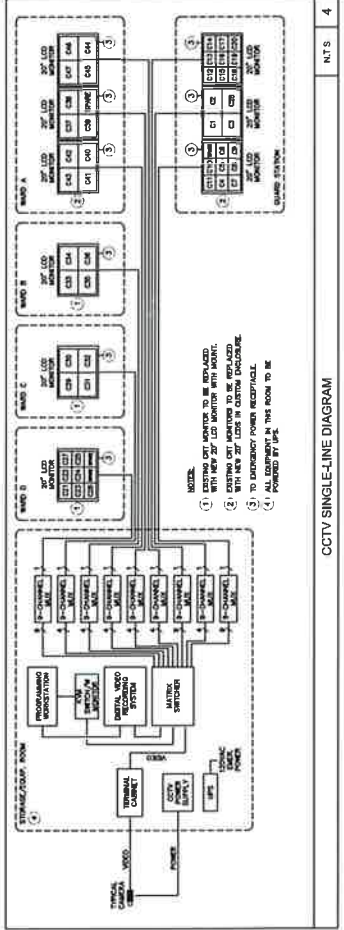
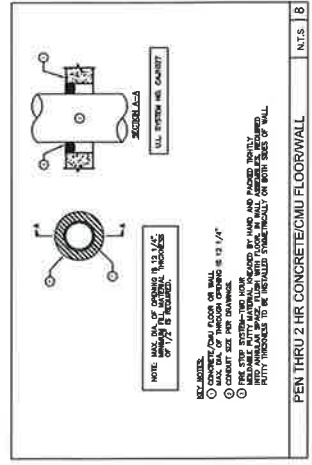
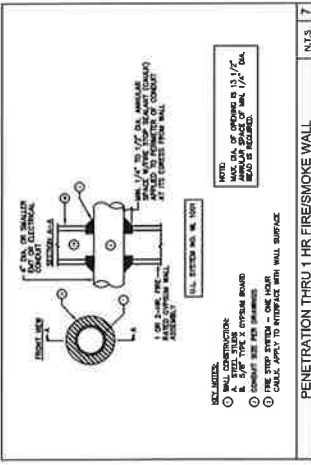
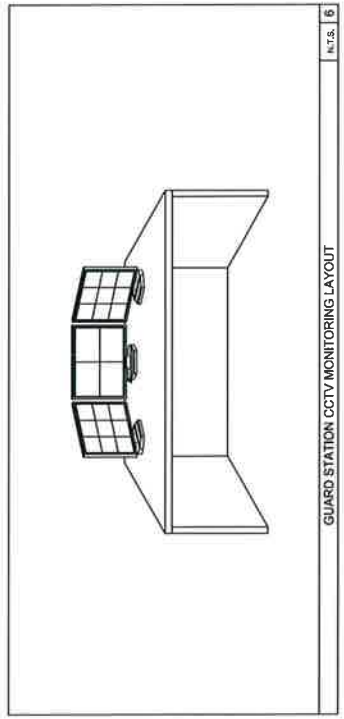
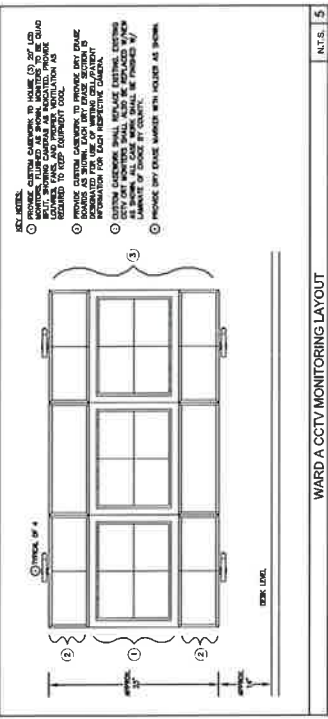
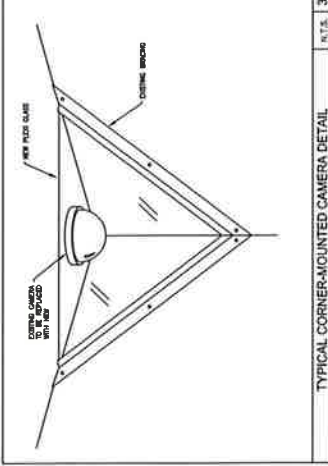
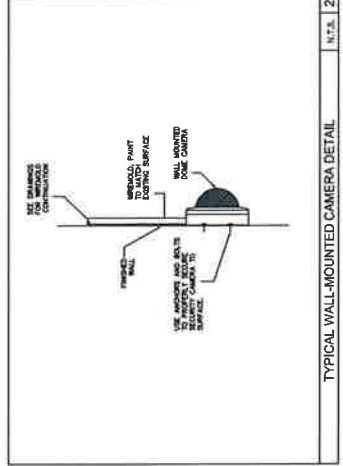
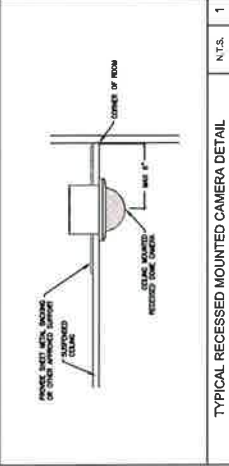

CCTV SINGLE-LINE DIAGRAM

NTS 4



OFFICE OF
CLERK OF THE BOARD OF SUPERVISORS
1st FLOOR, COUNTY ADMINISTRATIVE CENTER
P.O. BOX 1147, 4080 LEMON STREET
RIVERSIDE, CA 92502-1147
PHONE: (951) 955-1060
FAX: (951) 955-1071

KECIA HARPER-IHEM
Clerk of the Board of Supervisors

KIMBERLY A. RECTOR
Assistant Clerk of the Board

May 18, 2010

THE PRESS ENTERPRISE
ATTN: LEGALS
PO BOX 792
RIVERSIDE, CA 92501

VIA FAX (951) 368-9018
E-MAIL: legals@pe.com

RE: NOTICE INVITING BIDS: RCRMC Inpatient Treatment Facility Security Cameras and Monitors

To Whom It May Concern:

Attached is a copy for publication in your newspaper for **TWO (2) TIMES** on **two consecutive Thursdays: May 20 and 27, 2010.**

We require your affidavit of publication immediately upon completion of the last publication.

Your invoice must be submitted to this office in duplicate, WITH TWO CLIPPINGS OF THE PUBLICATION.

NOTE: PLEASE COMPOSE THIS PUBLICATION INTO A SINGLE COLUMN FORMAT.

Thank you in advance for your assistance and expertise.

Sincerely,

Mcgil

Cecilia Gil, Board Assistant to
KECIA HARPER-IHEM, CLERK OF THE BOARD

Gil, Cecilia

From: PE Legals [legals@pe.com]
Sent: Tuesday, May 18, 2010 8:25 AM
To: Gil, Cecilia
Subject: RE: FOR PUBLICATION: BIDS FOR RCRMC Inpatient Treatment Facility Security Cameras

Received for publication on May 20 and 27

Thank You! ~Maria G. Tinajero • The Press Enterprise Legal Adv. • 1.800.880.0345 (Phone) • 951.368.9018 (fax) • Please Note: Deadline is 10:30 AM two (2) business days prior to the date you would like to publish.

From: Gil, Cecilia [mailto:CCGIL@rcbos.org]
Sent: Tuesday, May 18, 2010 8:17 AM
To: PE Legals
Subject: FOR PUBLICATION: BIDS FOR RCRMC Inpatient Treatment Facility Security Cameras

Good Morning!

Attached is a Notice Inviting Bids for publication on 2 Thursdays: May 20 and 27, 2010. Please confirm. THANK YOU!

Cecilia Gil

Board Assistant to the
Clerk of the Board of Supervisors
951-955-8464

**THE COUNTY ADMINISTRATIVE CENTER IS CLOSED EVERY FRIDAY UNTIL FURTHER NOTICE.
PLEASE CONSIDER THE ENVIRONMENT BEFORE PRINTING.**

NOTICE INVITING BIDS

COUNTY OF RIVERSIDE, herein called Owner, invites sealed proposals for:

Security Cameras and Monitors Project

Proposals shall be delivered to the Clerk of the Board of Supervisors, on the 1st floor of the County Administrative Center located at 4080 Lemon Street, Riverside, CA 92501 no later than **1:30 pm on Thursday, June 17th, 2010** and will be promptly opened in public at said address.

Each Proposal shall be in accordance with the Plans, Specifications, and other Contract Documents dated **March, 2010** and prepared by:

P2S Engineering, Inc.

5000 E. Springs St., 8th Floor, Long Beach, CA 90815-5218
T (562) 497-2999 F (562) 497-2990

Plans & Specifications and Plan Holders List are available for purchase by contractors beginning May 20th, 2010 at:

Mission Reprographics
2050 E. La Cadena Dr. Suite L, Riverside, CA 92507
missionrepro@sbcglobal.net
Phone: (951) 686-8828

Notice of Award will be available at Mission Reprographics. missionrepro@sbcglobal.net

REQUEST FOR INFORMATION:

Contact: P2S Engineering, Inc.

Avenue to send RFI: All RFI's should be emailed to gary.jewell@p2seng.com or they may be faxed to (562) 497-2990. RFI's will not be answered via phone calls or any other means. **Deadline for RFI's is 5:00 PM on Monday, June 14th, 2010.**

Pursuant to the Labor Code, the Governing Board of the Owner has obtained from the Director of the Department of Industrial Relations, State of California, his determination of general prevailing rates of per diem wages applicable to the work, and for holiday and overtime work, including employer payments for health and welfare, pension, vacation, and similar purposes, as set forth on the schedule which is on file at the principal office of the Owner, and which will be made available to any interested person upon request.

The Contractor will be required per Public Contract Code §3300 and for this project, to have a State of California contractor's license classification **C-7**, or **B**. A mandatory pre-bid conference will be held on **June 8, 2010 at 09:00 hrs (am), meeting at 9990 County Farm Rd., Riverside, CA92503.**

Technical questions shall be addressed to **P2S Engineering, Inc.**, at the address and telephone listed above. For further information, contact Bruce Norris at the Department of Economic Development Agency, located at 3403 10th St., Suite 500, Riverside, CA 92507-4199 whose telephone number is (951) 955-0353.

Dated: May 18, 2010

Kecia Harper-Ihem, Clerk of the Board
By: Cecilia Gil, Board Assistant

Legal Advertising Invoice

① REMITTANCE ADDRESS
 POST OFFICE BOX 12009
 RIVERSIDE, CA 92502-2209
 FAX (951) 368-9026

① BILLING PERIOD 05/27/10 - 05/27/10
 ② BILLING DATE 05/27/10
 ③ TOTAL AMOUNT DUE 352.50
 ④ ADVERTISING/CLIENT NAME BOARD OF SUPERVISORS
 FOR BILLING INFORMATION CALL (951) 368-9713
 UNAPPLIED AMOUNT ⑤
 ⑥ PAGE NO 1
 ⑦ TERMS OF PAYMENT Due Upon Receipt

⑧ BILLED ACCOUNT NAME AND ADDRESS
 BOARD OF SUPERVISORS
 COUNTY OF RIVERSIDE
 P.O. BOX 1147
 RIVERSIDE CA 92502

⑨ BILLED ACCOUNT NUMBER 045202
 ⑩ REP NO LE04

Statement #: 56541873 Amount Paid \$ _____ Your Check # _____

PLEASE DETACH AND RETURN UPPER PORTION WITH YOUR REMITTANCE

⑪ DATE	⑫ REFERENCE	⑬ DESCRIPTION-OTHER COMMENTS/CHARGES	⑭ BILL SIZE ⑮ BILLED LINES	⑯ RATE	⑰ GROSS AMOUNT	⑱ NET AMOUNT
05/20	4188918 C0	NIB - RCRMC INPATIENT TREATMEN Class : 10 Ctext Ad# 10269955 Placed By : Cecilia Gil	141 L	1.30		183.30
05/27	4188918 C0	NIB - RCRMC INPATIENT TREATMEN Class : 10 Ctext Ad# 10269955 Placed By : Cecilia Gil	141 L	1.20		169.20

EDA
 3.24 of 05/04/10
12w

RECEIVED RIVERSIDE COUNTY
 CLERK / BOARD OF SUPERVISORS
 2010 JUN - 8 PM 3:27

⑲ CURRENT NET AMOUNT DUE	⑳ 30 DAYS	㉑ 60 DAYS	㉒ OVER 90 DAYS	㉓ UNAPPLIED AMOUNT	㉔ PLEASE PAY THIS AMOUNT
					352.50

THE PRESS-ENTERPRISE  P.O. BOX 12009
 RIVERSIDE, CA 92502-2209
 TELEPHONE (951) 368-9711
 (951) 368-9720 (951) 368-9713

ADVERTISING STATEMENT/INVOICE

* UNAPPLIED AMOUNTS ARE INCLUDED IN TOTAL AMOUNT DUE 

⑳ STATEMENT NUMBER	㉕ BILLING PERIOD	㉖ BILLED ACCOUNT NUMBER	㉗ ADVERTISER/CLIENT NUMBER	㉘ ADVERTISER/CLIENT NAME
56541873	05/27/10 - 05/27/10	045202		BOARD OF SUPERVISORS

THE PRESS-ENTERPRISE

3450 Fourteenth Street
Riverside CA 92501-3878
951-684-1200
951-368-9018 FAX

**PROOF OF PUBLICATION
(2010, 2015.5 C.C.P.)**

Press-Enterprise

PROOF OF PUBLICATION OF

Ad Desc.: NIB - RCRMC Inpatient Treatment Fac

I am a citizen of the United States. I am over the age of eighteen years and not a party to or interested in the above entitled matter. I am an authorized representative of THE PRESS-ENTERPRISE, a newspaper of general circulation, printed and published daily in the County of Riverside, and which newspaper has been adjudicated a newspaper of general circulation by the Superior Court of the County of Riverside, State of California, under date of April 25, 1952, Case Number 54446, under date of March 29, 1957, Case Number 65673 and under date of August 25, 1995, Case Number 267864; that the notice, of which the annexed is a printed copy, has been published in said newspaper in accordance with the instructions of the person(s) requesting publication, and not in any supplement thereof on the following dates, to wit:

05-20-10
05-27-10

I Certify (or declare) under penalty of perjury that the foregoing is true and correct.

Date: May. 27, 2010
At: Riverside, California

BOARD OF SUPERVISORS

P.O. BOX 1147
COUNTY OF RIVERSIDE
RIVERSIDE CA 92502

Ad #: 10269955

PO #:

Agency #: _____

Ad Copy:

NOTICE INVITING BIDS

COUNTY OF RIVERSIDE, herein called Owner, invites sealed proposals for:

Security Cameras and Monitors Project

Proposals shall be delivered to the Clerk of the Board of Supervisors, on the 1st floor of the County Administrative Center located at 4080 Lemon Street, Riverside, CA 92501 no later than 1:30 pm on Thursday, June 17th, 2010 and will be promptly opened in public at said address.

Each Proposal shall be in accordance with the Plans, Specifications, and other Contract Documents dated March, 2010 and prepared by:

P2S Engineering, Inc.
5000 E. Springs St., 8th Floor, Long Beach, CA 90815-5218
T (562) 497-2999 F (562) 497-2990

Plans & Specifications and Plan Holders List are available for purchase by contractors beginning May 20th, 2010 at:

Mission Reprographics
2050 E. La Cadena Dr. Suite L, Riverside, CA 92507
missionrepro@sbcglobal.net
Phone: (951) 686-8828

Notice of Award will be available at Mission Reprographics. missionrepro@sbcglobal.net

REQUEST FOR INFORMATION:

Contact: P2S Engineering, Inc.
Avenue to send RFI: All RFI's should be emailed to gary.jewell@p2seng.com or they may be faxed to (562) 497-2990. RFI's will not be answered via phone calls or any other means. Deadline for RFI's is 5:00 PM on Monday, June 14th, 2010.

Pursuant to the Labor Code, the Governing Board of the Owner has obtained from the Director of the Department of Industrial Relations, State of California, his determination of general prevailing rates of per diem wages applicable to the work, and for holiday and overtime work, including employer payments for health and welfare, pension, vacation, and similar purposes, as set forth on the schedule which is on file at the principal office of the Owner, and which will be made available to any interested person upon request.

The Contractor will be required per Public Contract Code §3300 and for this project, to have a State of California contractor's license classification C-7, or B. A mandatory pre-bid conference will be held on June 8, 2010 at 09:00 hrs (am), meeting at 9990 County Farm Rd., Riverside, CA 92503.

Technical questions shall be addressed to P2S Engineering, Inc., at the address and telephone listed above. For further information, contact Bruce Norris at the Department of Economic Development Agency, located at 3403 10th St., Suite 500, Riverside, CA 92507-4199 whose telephone number is (951) 955-0353.

Dated: May 18, 2010
Kecia Harper-Ihem, Clerk of the Board
By: Cecilia Gil, Board Assistant

5/20, 27

MEMORANDUM



RIVERSIDE COUNTY COUNSEL

June 28, 2010

TO: Jane Jennings
Clerk of the Board

FROM: Neal Kipnis
Deputy County Counsel

RE: EDA Project – RCRMC Inpatient Treatment Security Cameras

I am returning the bids for this project. The low bid from Datatel Wiring is approved as to form by this office.

Please let me know if you have any questions.

Enclosures

Bid Summary

TO: Pamela J. Walls
County Counsel

PROJECT: RCRM Inpatient Treatment
Security Cameras

FROM: Jane Jennings 955-8092
Clerk of the Board

BID DATE: 06/24/2010

OWNER: Bruce Norris - EDA
(951) 955-0353

BID TIME: 10:00 a.m.

ITEM/DATE: #3.24 of 05/04/10

CONTRACTORS

BASE BID

Datatel Wiring Products, Inc.
1501 Seventh Street, Suite D
Riverside, CA 92507
(951) 788-1888

Base Bid: \$ 103,680.00
Alternate: \$ + 1,000.00

Safeway Building Services, Inc.
dba: Safeway Security Systems
1474 N. Miller Dr.
Colton, CA 92324
(909) 824-7980

Base Bid: \$ 199,000.00
Alternate: \$ + 1,379.00

RECEIVED
JUN 28 2010
COUNTY COUNSEL
TO

ARK

SPECIFICATIONS AND CONTRACT DOCUMENTS
FOR

Riverside County Inpatient Mental Health treatment Facility Camera
Project
FM2008001851



PREPARED BY
COUNTY OF RIVERSIDE
ECONOMIC DEVELOPMENT AGENCY
DESIGN & CONSTRUCTION DIVISION
April 1, 2010

FORM APPROVED COUNTY COUNSEL
BY: Marshall Victor 4/12/10
MARSHAL L VICTOR DATE

NOTICE INVITING BIDS

COUNTY OF RIVERSIDE, herein called Owner, invites sealed proposals for :

Mental Health In-patient Treatment Facility Camera Project

This Project is to install all new camera's, monitors and equipment, in wards A,B,C & D of the In-Patient Mental Health Treatment Facility, in compliance to the drawings and specifications. In strict adherence to requirements of OSHPD. At 9990 County Farm Rd, Riverside, CA.

Proposals shall be delivered to the Clerk of the Board of Supervisors, on the 1st floor of the County Administrative Center located at 4080 Lemon Street, Riverside, CA 92501 no later than _____ and will be promptly opened in public at said address.

Each Proposal shall be in accordance with the Plans, Specifications, and other Contract Documents and prepared by P2S ENGINEERING. A nonrefundable fee of (\$35.00) will be charged for each set of Plans and Specifications furnished to Contractors. An additional nonrefundable fee will be charged for each set of Plans and Specifications furnished that are requested to be mailed to Contractors. Plans and Specifications may be obtained from Mission Reprographics, 2050E. La Cadena Drive Suite L Riverside, CA 92507, 951-686-8828.

Pursuant to the Labor Code, the Governing Board of the Owner has obtained from the Director of the Department of Industrial Relations, State of California, his determination of general prevailing rates of per diem wages applicable to the work, and for holiday and overtime work, including employer payments for health and welfare, pension, vacation, and similar purposes, as set forth on the schedule which is on file at the principal office of the Owner, and which will be made available to any interested person upon request.

The Contract General Conditions for this project will contain provisions allowing successful contractor to substitute securities for monies withheld by the County to ensure performance (Public Contract Code 22300).

A Performance Bond and Payment Bond shall be required for this Project.

The Contractor will be required, per Public Contracts Code, Section 3300 and for this contract, to have a State of California contractor's license classification C-7, and or B – General Building Contractor. A **mandatory pre-bid job walk inspection** will be held on _____, meeting at the Mental Health Treatment Facility at 9990 County Farm Rd. **No bids will be accepted from bidders who have not attended the pre-bid job walk.**

For further information, contact Bruce Norris at the Economic Development Agency, Design and Construction located at 3403 10th St, Riverside, CA 92501 whose telephone number is (951) 955-03534843.

MO. _____

Advertize Riv. Press _____



June 15, 2010

RCRMC Mental Health Camera Project

Addendum #1

Good afternoon everyone.

This is to inform you that I have extended the bid closing date to Wednesday, June 23rd, 2010, at 15:00 hrs (3:00 pm). Due to the delay in getting the responses out for the RFI's, and the concern from some of the bid participants in not having sufficient time to put their bids together, I agreed that it would be better to extend the bid closing date.

If there are any questions concerning the change in date and time, please contact me directly.

Respectfully,

Bruce Norris

Project Manager
EDA PMO
(951) 955-0353

www.rivcoeda.org

Administration
Auction
Business Intelligence
Cultural Services
Community Services
Economic

Housing
Housing Authority
Information Technology
Maintenance
Marketing

Economic Development
Edward-Dean Museum
Environmental Planning
Fair & National Date Festival
Foreign Trade
Grants/Assessment

Parking
Project Management
Purchasing Group
Real Property
Redevelopment Agency
Workforce Development



June 18, 2010

RRCMC Mental Health Camera Project

Addendum #2

Good afternoon everyone,

The location for the security Guard post will remain as per plans and specifications.

Addendum #2

Please include in your bid as add alternate #1: Secondary power source to be fed from the E-Panel located in the Generator room, this power is to supply the two fourplex receptacles referenced in the plans and spec's.

If there are any questions concerning the change in date and time, please contact me directly.

Respectfully,

Bruce Norris

Project Manager
EDA PMO
(951) 955-0353

www.rivcoeda.org

Agriculture
Aviation
Business Assistance
Cultural Services
Community Services
Courts & J

Housing
Housing Authority
Information Technology
Maintenance
Marketing

Economic Development
Edward Dean Museum
Environmental Planning
Fair & Traditional Date Festival
Foreign Trade
Grant Abatement

Parking
Project Management
Purchasing Group
Real Property
Redevelopment Agency
Workforce Development



June 21, 2010

RCRMC Mental Health Camera Project

Addendum #3

Good afternoon everyone,

Due to some challenges getting some information, I am extending the bid date by one more day to Thursday, June 24th, at 10:00 hrs. If there are any questions concerning the change in date and time, please contact me directly.

Respectfully,

Bruce Norris

Project Manager
EDA PMO
(951) 955-0353

www.rivcoeda.org

Administration
Aviation
Business Intelligence
Cultural Services
Community Services
DARTS

Housing
Housing Authority
Information Technology
Maintenance
Marketing

Economic Development
Edward Dean Museum
Environmental Planning
Fair & National Date Festival
Foreign Trade
Gratuity Abatement

Parking
Project Management
Purchasing Group
Real Property
Redevelopment Agency
Workforce Development

CONTRACTOR'S PROPOSAL

TO THE GOVERNING BOARD OF THE COUNTY OF RIVERSIDE:

Date: June 23, 2010

Bidder: Datatel Wiring Products, Inc.

The undersigned, having carefully examined the proposed site and the Plans and Specifications, the Notice Inviting Bids, the Instructions to Bidders, the Agreement Form, the Bond Forms, the General Conditions for the Construction of Third Street and Park Avenue Parking lot, hereby proposes and agrees to furnish all tools, equipment, services, apparatus, facilities, transportation, labor and materials necessary to complete the work in strict conformity with the Plans and Specifications, including all work specified in Addenda numbered and dated:

Addendum No. 1 Date June 15, 2010

Addendum No. 2 Date June 18, 2010

Addendum No. 3 Date June 21, 2010

One Hundred Three Thousand Six
For the total Base Bid Hundred Eighty Dollars dollars (\$ 103,680.00),
including all applicable taxes, permits, licenses, **AND Course of Construction Insurance.**

		(Add or Deduct state which)
Alternate 1	\$ <u>1,000.00</u>	<u>Add</u>
Alternate 2	\$ _____	_____
Alternate 3	\$ _____	_____
Alternate 4	\$ _____	_____

And,
Cost of Contractor's Course of Construction Insurance N/A dollars (\$ _____)
and deductible \$ N/A.

Bids must be submitted on all items. Failure to bid on all items may result in the bid being rejected as non-responsive. The basis for award will be the qualified bidder with the lowest total of the Base Bid WITH COURSE OF CONSTRUCTION INSURANCE and all alternates. Alternates may be awarded in any order after determination of the lowest responsible and responsive bidder.

AWARD OF CONTRACT

The undersigned fully understands that a Contract is formed upon the acceptance of this Proposal by the Owner and the undersigned further agrees that upon request he will promptly execute and deliver to Owner a written memorial of the Contract together with the required Payment and Performance Bonds and proof of insurance.

BID GUARANTEE

The enclosed certified or cashier's check or bidder's bond on approved form, made payable to the Owner in the amount of ten percent of the total bid submitted herewith, is hereby given as a guarantee that the bidder will execute and deliver the above mentioned written memorial and required bonds and insurance if awarded the contract, and in the event that the undersigned fails or refuses to execute and deliver said documents, such check or bond is to be charged with the costs of the damages experienced by the Owner as a result of such failure or refusal, including but not limited to publication costs, the difference in money between the amount of the bid of the said principal and the amount for which obligee may legally contract with another party to perform the said work if such amount be in excess of the former, building lease or rental costs, transportation costs and additional salary costs that result from the delay due to the principal's default on the awarded contract. In no event, however, shall the Surety's liability exceed the penal sum hereof.

Name of Bidder: Datatel Wiring Products, Inc.

Type of Organization: a S Corporation

Signed By: Shu Mei Lin 

Title of Signer: Secretary/ Treasure

Affix Seal
if
Corporation

Address of Bidder: 1501 Seventh Street, Suite D
Riverside, CA 92507

Telephone No.: (951) 788-1888

Contractor's License No.: 719634

Classification: C-7 Low Voltage Expiration Date: 03/31/2012

LICENSURE STATEMENTS ARE MADE UNDER PENALTY OF PERJURY

If bidder is a corporation, and signer is not President or Secretary, attach a certified copy of By-Laws or resolution authorizing execution. If bidder is a corporation, affix corporate seal. If signer is an agent, attach Power of Attorney. If bidder is not an individual, list names of other persons authorized to bind the organization.

**NONCOLLUSION AFFIDAVIT TO BE EXECUTED BY BIDDER AND
SUBMITTED WITH BID**

State of California) ss.
County of Riverside)

CHIH CHUNG CHEN, being first duly sworn, deposes and says:

That he or she is Project Manager of Datatel Wiring Products, Inc the party making the foregoing bid; that the bid is not made in the interest of, or on behalf of, any undisclosed person, partnership, company, association, organization, or corporation; that the bid is genuine and not collusive or sham; that the bidder has not directly or indirectly induced or solicited any other bidder to put in a false or sham bid, and has not directly or indirectly colluded, conspired, connived, or agreed with any bidder or anyone else to put in a sham bid, or that anyone shall refrain from bidding; that the bidder has not in any manner, directly or indirectly, sought by agreement, communication, or conference with anyone to fix the bid price of the bidder or any other bidder, or to fix any overhead, profit, or cost element of the bid price, or of that of any other bidder, or to secure any advantage against the public body awarding the contract of anyone interested in the proposed contract; that all statements contained in the bid are true; and, further, that the bidder has not, directly or indirectly, submitted his or her bid price or any breakdown thereof, or the contents thereof, or divulged information or data relative thereto, or paid, and will not pay, any fee to any corporation, partnership, company, association, organization, bid depository, or to any member or agent thereof to effectuate a collusive or sham bid.

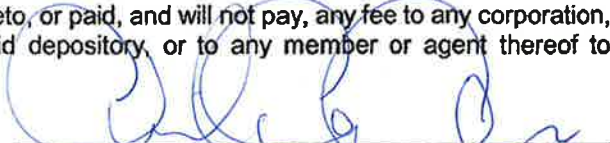
Signature CHIH CHUNG CHEN

Subscribed and sworn to before me this _____ day of _____, 2009

Signature of officer administering oath

State of California
County of RIVERSIDE
Subscribed and sworn to (or affirmed) before me on this 16TH
day of JUNE 2010 by CHIH CHUNG CHEN



proved to me on the basis of satisfactory evidence to be the person(s) who appeared before me.
Signature P. Kesuma

Bid Bond

Bond No. DSI24

KNOWN TO ALL MEN BY THESE PRESENTS, that we, the undersigned DATATEL WIRING PRODUCTS, INC., as Principal; and Developers Surety and***, as Surety, are hereby held and firmly bound unto the County of Riverside, hereinafter called the "Owner", in the sum of TEN PERCENT (10%) OF THE AMOUNT BID Dollars (\$ 10%) for the payment of such sum, well and truly to be made, do hereby jointly and severally bind ourselves, our heirs, executors, administrators, successors and assigns. ***Indemnity Company

WHEREAS, the said Principal is herewith submitting its Proposal for the Mental Health In-Patient Treatment Facility Camera Project located at 990 County Farm Rd., Riverside, CA

THE CONDITION OF THE ABOVE OBLIGATION IS SUCH, that if the aforesaid Principal shall be awarded the Contract upon said Proposal and shall, within the required number of days after the notice of such award, execute a written memorial of the awarded Contract and submit the required Labor and Material Payment and faithful Performance Bond and proof of insurance, then this obligation shall be null and void; and in the event that the Principal fails and/or refuses to execute and deliver said documents this Bond will be charged with the costs of the damages experienced by the Owner as a result of such refusal, including but not limited to, publication cost, the difference in money between the amount of the bid of the said Principal and the amount for which the obligee may legally contract with another party to perform the said work if such amount be in excess of the former; building lease or rental costs, transportation cost, and additional salary costs that result from the delay due to the Principal's default on the awarded Contract. In no event however, shall the Surety's liability exceed the penal sum hereof.

The Surety, for value received, hereby stipulates and agrees that the obligations of said Surety and its bond shall be in no way impaired or affected by any extension of the time within which the Owner may accept such bid; and said Surety does hereby waive notice of any such extension.

IN WITNESS WHEREOF, the above bounded parties have executed this instrument under their separate seals this 10th day of June, 2010, ~~2009~~ the name and corporate seal of each corporate party being hereto affixed and those present duly signed by its undersigned representative, pursuant to authority of its governing body.

Datatel Wiring Products, Inc.
(Firm Name - Principal)
1501 Seventh Street, Suite D, Riverside, CA 92507

(Business Address)
By 
(Original Signature) Shu Mei Lin
Secretary/Treasure

Affix Seal
If
Corporation

Developers Surety and Indemnity Company
(Corporation Name - Surety)
3517 Camino Del Rio South; Ste 200, San Diego, CA 92108

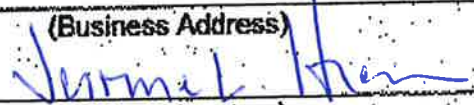
(Business Address)
By 
(Original Signature)
Jerome L. Hren, Attorney-In-Fact

Affix
Corporate
Seal

POWER OF ATTORNEY FOR
DEVELOPERS SURETY AND INDEMNITY COMPANY
INDEMNITY COMPANY OF CALIFORNIA
PO Box 19725, IRVINE, CA 92623 (949) 263-3300

KNOW ALL MEN BY THESE PRESENTS, that as except as expressly limited, DEVELOPERS SURETY AND INDEMNITY COMPANY and INDEMNITY COMPANY OF CALIFORNIA, do each, hereby make, constitute and appoint:

*** Jerome L. Hren ***

as their true and lawful Attorney(s)-in-Fact, to make, execute, deliver and acknowledge, for and on behalf of said corporations, as sureties, bonds, undertakings and contracts of suretyship giving and granting unto said Attorney(s)-in-Fact full power and authority to do and to perform every act necessary, requisite or proper to be done in connection therewith as each of said corporations could do, but reserving to each of said corporations full power of substitution and revocation, and all of the acts of said Attorney(s)-in-Fact, pursuant to these presents, are hereby ratified and confirmed.

This Power of Attorney is granted and is signed by facsimile under and by authority of the following resolutions adopted by the respective Board of Directors of DEVELOPERS SURETY AND INDEMNITY COMPANY and INDEMNITY COMPANY OF CALIFORNIA, effective as of January 1st, 2008.

RESOLVED, that the chairman of the Board, the President and any Vice President of the corporation be, and that each of them hereby is, authorized to execute Powers of Attorney, qualifying the attorney(s) named in the Powers of Attorney to execute, on behalf of the corporations, bonds, undertakings and contracts of suretyship; and that the Secretary or any Assistant Secretary of the corporations be, and each of them hereby is, authorized to attest the execution of any such Power of Attorney;

RESOLVED, FURTHER, that the signatures of such officers may be affixed to any such Power of Attorney or to any certificate relating thereto by facsimile, and any such Power of Attorney or certificate bearing such facsimile signatures shall be valid and binding upon the corporations when so affixed and in the future with respect to any bond, undertaking or contract of suretyship to which it is attached.

IN WITNESS WHEREOF, DEVELOPERS SURETY AND INDEMNITY COMPANY and INDEMNITY COMPANY OF CALIFORNIA have severally caused these presents to be signed by their respective Vice President and attested by their respective Assistant Secretary this January 1st, 2008.

By: Stephen T. Pate
Stephen T. Pate, Senior Vice President

By: Charles L. Day
Charles L. Day, Assistant Secretary



State of California
County of Orange

On August 13th, 2008 before me, Jenny TT Nguyen, Notary Public
Date Here Insert Name and Title of the Officer

personally appeared Stephen T. Pate and Charles L. Day
Name(s) of Signer(s)



Place Notary Seal Above

who proved to me on the basis of satisfactory evidence to be the person(s) whose name(s) is/are subscribed to the within instrument and acknowledged to me that he/she/they executed the same in his/her/their authorized capacity(ies), and that by his/her/their signature(s) on the instrument the person(s), or the entity upon behalf of which the person(s) acted, executed the instrument.

I certify under PENALTY OF PERJURY under the laws of the State of California that the foregoing paragraph is true and correct.

WITNESS my hand and official seal.

Signature Jenny TT Nguyen
Jenny TT Nguyen

CERTIFICATE

The undersigned, as Assistant Secretary, of DEVELOPERS SURETY AND INDEMNITY COMPANY and INDEMNITY COMPANY OF CALIFORNIA, does hereby certify that the foregoing Power of Attorney remains in full force and has not been revoked, and furthermore, that the provisions of the resolutions of the respective Boards of Directors of said corporations set forth in the Power of Attorney, are in force as of the date of this Certificate.

This Certificate is executed in the City of Irvine, California, the 10th day of June, 2010

By: Albert Hillebrand
Albert Hillebrand, Assistant Secretary

CALIFORNIA ALL-PURPOSE ACKNOWLEDGMENT

State of California

County of San Diego

On June 10, 2010 before me, Jennifer H. Hoagland, Notary Public,

personally appeared Jerome L. Hren,

who proved to me on the basis of satisfactory evidence to be the person(s) whose name(s) is/are subscribed to the within instrument and acknowledged to me that he/she/they executed the same in his/her/their authorized capacity(ies), and that by his/her/their signature(s) on the instrument the person(s), or the entity upon behalf of which the person(s) acted, executed the instrument.

I certify under PENALTY OF PERJURY under the laws of the State of California that the foregoing paragraph is true and correct.

WITNESS my hand and official seal.



Signature Jennifer H. Hoagland (Seal)

OPTIONAL

Though the data below is not required by law, it may prove valuable to persons relying on the document and could prevent fraudulent reattachment of this form.

CAPACITY CLAIMED BY SIGNER

DESCRIPTION OF ATTACHED DOCUMENT

- INDIVIDUAL
- CORPORATE OFFICER

- PARTNER(S) LIMITED
- ATTORNEY-IN-FACT
- TRUSTEE(S)
- GUARDIAN/CONSERVATOR

OTHER:

SIGNER IS REPRESENTING:
NAME OF PERSON(S) OR ENTITY(IES)

Developers Surety and Indemnity Company

DATATEL WIRING PRODUCTS, INC.
1501 SEVENTH ST. #D
RIVERSIDE, CA 92507
TEL (951) 788-1888
FAX (951) 784-1888

RECEIVED RIVERSIDE COUNTY
CLERK / BOARD OF SUPERVISORS

2010 JUN 24 AM 9: 22

SEALED BID RECEIVED
CLERK OF THE BOARD OF SUPERVISORS

BID PROPOSAL FOR

**RIVERSIDE COUNTY INPATIENT MENTAL
HEALTH TREATMENT FACILITY
CAMERA PROJECT
FM2008001851**

BID DATE: JUNE 24, 2010 @ 10:00 AM

**Deliver to: Riverside County Clerk of the Board of Supervisors
1st Floor of the County Administrative Center
4080 Lemon Street
Riverside, CA 92501**

SPECIFICATIONS AND CONTRACT DOCUMENTS
FOR

Riverside County Inpatient Mental Health treatment Facility Camera
Project
FM2008001851



PREPARED BY
COUNTY OF RIVERSIDE
ECONOMIC DEVELOPMENT AGENCY
DESIGN & CONSTRUCTION DIVISION
April 1, 2010

FORM APPROVED COUNTY COUNSEL
BY: Marsha L. Victor 4/12/10
MARSHA L. VICTOR DATE

CONTRACTOR'S PROPOSAL

TO THE GOVERNING BOARD OF THE COUNTY OF RIVERSIDE:

Date: June 23, 2010

Bidder: Safeway Building Services, Inc. DBA: Safeway Security Systems

The undersigned, having carefully examined the proposed site and the Plans and Specifications, the Notice Inviting Bids, the Instructions to Bidders, the Agreement Form, the Bond Forms, the General Conditions for the Construction of Third Street and Park Avenue Parking lot, hereby proposes and agrees to furnish all tools, equipment, services, apparatus, facilities, transportation, labor and materials necessary to complete the work in strict conformity with the Plans and Specifications, including all work specified in Addenda numbered and dated:

Addendum No. 1 Date June 18, 2010

Addendum No. 2 Date June 21, 2010

Addendum No. 3 Date June 21, 2010

For the total Base Bid One hundred ninety-nine thousand dollars (\$ 199,000.00), including all applicable taxes, permits, licenses, **AND Course of Construction Insurance.**

		(Add or Deduct state which)
Alternate 1	\$ <u>1379.00</u>	<u>ADD</u>
Alternate 2	\$ _____	_____
Alternate 3	\$ _____	_____
Alternate 4	\$ _____	_____

And,
Cost of Contractor's Course of Construction Insurance N/A dollars (\$ _____)
and deductible \$ _____.

Bids must be submitted on all items. Failure to bid on all items may result in the bid being rejected as non-responsive. The basis for award will be the qualified bidder with the lowest total of the Base Bid WITH COURSE OF CONSTRUCTION INSURANCE and all alternates. Alternates may be awarded in any order after determination of the lowest responsible and responsive bidder.

AWARD OF CONTRACT

The undersigned fully understands that a Contract is formed upon the acceptance of this Proposal by the Owner and the undersigned further agrees that upon request he will promptly execute and deliver to Owner a written memorial of the Contract together with the required Payment and Performance Bonds and proof of insurance.

BID GUARANTEE

The enclosed certified or cashier's check or bidder's bond on approved form, made payable to the Owner in the amount of ten percent of the total bid submitted herewith, is hereby given as a guarantee that the bidder will execute and deliver the above mentioned written memorial and required bonds and Insurance if awarded the contract, and in the event that the undersigned fails or refuses to execute and deliver said documents, such check or bond is to be charged with the costs of the damages experienced by the Owner as a result of such failure or refusal, including but not limited to publication costs, the difference in money between the amount of the bid of the said principal and the amount for which obligee may legally contract with another party to perform the said work if such amount be in excess of the former, building lease or rental costs, transportation costs and additional salary costs that result from the delay due to the principal's default on the awarded contract. In no event, however, shall the Surety's liability exceed the penal sum hereof.

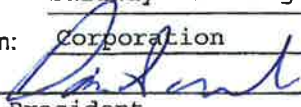
Name of Bidder: Safeway Building Services, Inc. DBA: Safeway Security Systems
Type of Organization: Corporation
Signed By: 
Title of Signer: President
Address of Bidder: 1474 N. Miller Dr.
Colton, CA 92324
Telephone No.: 909-824-7980
Contractor's License No.: 387886
Classification: B, C&, C19, C46 Expiration Date: 2/29/12

Affix Seal
If
Corporation

LICENSURE STATEMENTS ARE MADE UNDER PENALTY OF PERJURY

If bidder is a corporation, and signer is not President or Secretary, attach a certified copy of By-Laws or resolution authorizing execution. If bidder is a corporation, affix corporate seal. If signer is an agent, attach Power of Attorney. If bidder is not an individual, list names of other persons authorized to bind the organization.

**NONCOLLUSION AFFIDAVIT TO BE EXECUTED BY BIDDER AND
SUBMITTED WITH BID**

State of California) ss.
County of Riverside)

Daniel Scherneck, being first duly sworn, deposes and says:

That he or she is President of Safeway Building Services, Inc.
the party making the foregoing bid; that the bid is not made in the interest of, or on behalf of, any undisclosed person, partnership, company, association, organization, or corporation; that the bid is genuine and not collusive or sham; that the bidder has not directly or indirectly induced or solicited any other bidder to put in a false or sham bid, and has not directly or indirectly colluded, conspired, connived, or agreed with any bidder or anyone else to put in a sham bid, or that anyone shall refrain from bidding; that the bidder has not in any manner, directly or indirectly, sought by agreement, communication, or conference with anyone to fix the bid price of the bidder or any other bidder, or to fix any overhead, profit, or cost element of the bid price, or of that of any other bidder, or to secure any advantage against the public body awarding the contract of anyone interested in the proposed contract; that all statements contained in the bid are true; and, further, that the bidder has not, directly or indirectly, submitted his or her bid price or any breakdown thereof, or the contents thereof, or divulged information or data relative thereto, or paid, and will not pay, any fee to any corporation, partnership, company, association, organization, bid depository, or to any member or agent thereof to effectuate a collusive or sham bid.



Signature

Subscribed and sworn to before me this 22 day of June 2010, ~~2009~~X

Signature of officer administering oath

Bid Bond

KNOWN TO ALL MEN BY THESE PRESENTS, that we, the undersigned Safeway Building Services, Inc. dba. Safeway Electric, as Principal; and Nationwide Mutual Insurance Company, as Surety, are hereby held and firmly bound unto the County of Riverside, hereinafter called the "Owner", in the sum of 10 Percent of Bid Dollars (\$ 10%) for the payment of such sum, well and truly to be made, do hereby jointly and severally bind ourselves, our heirs, executors, administrators, successors and assigns.

WHEREAS, the said Principal is herewith submitting its Proposal for the JOB- FM2008001851 Riverside County inPatient Mental Health Treatment Facility Camera Project. City of Riverside, a Municipal Corporation Install new cameras, monitors, & equipment in wards A,B,C &D of the in-Patient Treatments Facility.

THE CONDITION OF THE ABOVE OBLIGATION IS SUCH, that if the aforesaid Principal shall be awarded the Contract upon said Proposal and shall, within the required number of days after the notice of such award, execute a written memorial of the awarded Contract and submit the required Labor and Material Payment and faithful Performance Bond and proof of insurance, then this obligation shall be null and void; and in the event that the Principal fails and/or refuses to execute and deliver said documents this Bond will be charged with the costs of the damages experienced by the Owner as a result of such refusal, including but not limited to, publication cost, the difference in money between the amount of the bid of the said Principal and the amount for which the obligee may legally contract with another party to perform the said work if such amount be in excess of the former; building lease or rental costs, transportation cost, and additional salary costs that result from the delay due to the Principal's default on the awarded Contract. In no event however, shall the Surety's liability exceed the penal sum hereof.

The Surety, for value received, hereby stipulates and agrees that the obligations of said Surety and its bond shall be in no way impaired or affected by any extension of the time within which the Owner may accept such bid; and said Surety does hereby waive notice of any such extension.

IN WITNESS WHEREOF, the above bounded parties have executed this instrument under their separate seals this 21st day of June, 2010, 2009, the name and corporate seal of each corporate party being hereto affixed and those present duly signed by its undersigned representative, pursuant to authority of its governing body.

Safeway Building Services Inc., dba Safeway Electric
(Firm Name - Principal)

1474 N. Miller Drive Colton, CA 92324
(Business Address)

By *[Signature]*
(Original Signature)

Daniel Scherneck, President
(Title)

Nationwide Mutual Insurance Company
(Corporation Name - Surety)

130 W. Vine Street Redlands, CA 92373
(Business Address)

By *[Signature]*
(Original Signature)

Affix Seal
If
Corporation

Affix
Corporate
Seal

Richard Beall, President - Attorney- In- Fact



Power of Attorney

KNOW ALL MEN BY THESE PRESENTS THAT Nationwide Mutual Insurance Company, a corporation organized under the laws of the State of Ohio, with its principal office in the City of Columbus, Ohio, hereinafter called "Company", does hereby make, constitute and appoint **RICHARD BEALL**, **KAREN BJORNESTAD**

REDLANDS CA

each in their individual capacity, its true and lawful Attorney-In-Fact with full power and authority to sign, seal, and execute in its behalf any and all bonds and undertakings and other obligatory instruments of similar nature in penalties not exceeding the sum of **FIVE HUNDRED THOUSAND AND NO/100 DOLLARS \$ 500,000.00** and to bind the Company thereby, as fully and to the same extent as if such instruments were signed by the duly authorized officers of the Company; and all acts of said Attorney pursuant to the authority hereby given are hereby ratified and confirmed.

This Power of Attorney is made and executed pursuant to and by authority of the following resolution duly adopted by the Board of Directors of the Company.

"RESOLVED, that the President, or any Senior Vice President, Resident Vice President or Second Vice President by, and the same hereby is, authorized and empowered to appoint Attorneys-In-Fact of the Company and to authorized them to execute any and all bonds, undertakings, recognizances, contracts of indemnity, policies, contracts guaranteeing the fidelity of persons holding positions of public or private trust, and other writings obligatory in nature which the business of the Company may require; and to modify or revoke, with or without cause, any such appointment or authority. The authority granted hereby shall in no way limit the authority of other duly authorized agents to sign and countersign any of said documents on behalf of the Company."

"RESOLVED FURTHER, that such Attorneys-In-Fact shall have full power and authority to execute and deliver any and all such documents and to bind the Company, subject to the terms and limitations of the power of attorney issued to them, and to affix the seal of the Company thereto, provided, however, that said seal shall not be necessary for the validity of any such documents."

This Power of Attorney is signed and sealed by facsimile under and by the following By-Laws duly adopted by the Board of Directors of the Company.

ARTICLE VIII

"Section 10. Execution of instruments . Any Vice President and any Assistant Secretary or Assistant Treasurer shall have the power and authority to sign or attest all approved documents, instruments, contracts or other papers in connection with the operation of the business of the company in addition to the Chairman and Chief Executive Officer, President, Treasurer and Secretary; provided, however, the signature of any of them may be printed, engraved or stamped on any approved document, contract, instrument or other papers of the Company.

IN WITNESS WHEREOF, the said Nationwide Mutual Insurance Company has caused this instrument to be sealed and duly attested by the signature of its Vice President the 28th day of April, 1999.

ACKNOWLEDGMENT

STATE OF IOWA
COUNTY OF POLK SS



By:

Stephen S. Rasmussen
President

On this 28th day of April, 1999, before me came the above named Vice President for Nationwide Mutual Insurance Company, to me personally known to be the officer described in and who executed the preceding instrument, and he acknowledged the execution of the same, and being by me duly sworn, deposes and says, that he is the officer of the Company aforesaid, that the seal affixed thereto is the corporate seal of said Company, and the said corporate seal and his signature were duly affixed and subscribed to said instrument by the authority and direction of said Company.



Sandy Alitz

Notary Public
My Commission expires March 24, 2011

CERTIFICATE

I, John F. Delaloye, Assistant Secretary of Nationwide Mutual Insurance Company, do hereby certify that the Resolution included herein is a true and correct transcript from the minutes of the meeting of the Board of Directors duly called and held on the 6th day of September, 1967, and the same has not been revoked or amended in any manner; that said Stephen S. Rasmussen was on the date of the execution of the foregoing Power of Attorney the duly elected Vice President of Nationwide Mutual Insurance Company and the corporate seal and his signature as Vice President were duly affixed and subscribed to the said instrument by the authority of said Board of Directors.

IN WITNESS WHEREOF, I have hereunto subscribed my name as Assistant Secretary, and affixed the corporate seal of said Company this _____ day of _____,

21st JUNE 2010

23101

This Power of Attorney expires



John F. Delaloye
Assistant Secretary

State of California)
County of San Bernardino)

CALIFORNIA ALL-PURPOSE CERTIFICATE OF ACKNOWLEDGMENT

On June 21, 2010 before me, Gabrielle B. Fulton, Notary Public,
(here insert name and title of the officer)

personally appeared Richard Beall

N/A

who proved to me on the basis of satisfactory evidence to be the person(s) whose name(s) is/are subscribed to the within instrument and acknowledged to me that he/she/they executed the same in his/her/their authorized capacity(ies), and that by his/her/their signature(s) on the instrument the person(s), or the entity upon behalf of which the person(s) acted, executed the instrument.

I certify under PENALTY OF PERJURY under the laws of the State of California that the foregoing paragraph is true and correct.



WITNESS my hand and official seal.

Signature Gabrielle B. Fulton

(Seal)

OPTIONAL INFORMATION

Although the information in this section is not required by law, it could prevent fraudulent removal and reattachment of this acknowledgment to an unauthorized document and may prove useful to persons relying on the attached document.

Description of Attached Document

The preceding Certificate of Acknowledgment is attached to a document titled/for the purpose of _____

containing _____ pages, and dated _____

The signer(s) capacity or authority is/are as:

- Individual(s)
 Attorney-in-Fact
 Corporate Officer(s) _____
Title(s)

- Guardian/Conservator
 Partner - Limited/General
 Trustee(s)
 Other: _____

representing: _____
Name(s) of Person(s) or Entity(ies) Signer Is Representing

Additional Information

Method of Signer Identification

Proved to me on the basis of satisfactory evidence:
 form(s) of identification credible witness(es)

Notarial event is detailed in notary journal on:
Page # _____ Entry # _____

Notary contact: _____

Other

- Additional Signer(s) Signer(s) Thumbprint(s)

AGREEMENT FORM

THIS AGREEMENT, entered into this 22 day of June, 2010, by and between Roadway Engineering & Contracting Inc., hereinafter called the "Contractor", and the County of Riverside hereinafter called the "Owner".

WITNESSETH: That the parties hereto have mutually covenanted and agreed as follows:

CONTRACT: The Complete Contract includes all of the Contract Documents, to wit: The Notice Inviting Bids, the Instructions to Bidders, the Contractor's Proposal, Wage Schedule, Payment and Performance Bonds, the Plans and Specifications plus any Addenda thereto, the General Conditions, the Supplementary General Conditions, if applicable and this Agreement. All Contract Documents are intended to cooperate and be complimentary so that any work called for in one and not mentioned in the other, or vice versa, is to be executed the same as if mentioned in all Contract Documents.

STATEMENT OF WORK: The Contractor hereby agrees to furnish all tools, equipment, services, apparatus, facilities, transportation, labor and materials for the County Farm Inpatient Treatment Facility, in strict accordance with the Plans and Specifications dated March 2010 prepared by P2S Engineering herein after called the "Architect", including addenda thereto as listed in the Contractor's Proposal, all of which are made a part hereof.

TIME FOR COMPLETION: The work shall be commenced on a date to be specified in a written order of the Architect and shall be completed within sixty (90) calendar days from and after said date. It is expressly agreed that except for extensions of time duly granted in the manner and for the reasons specified in the General Conditions, time shall be of the essence.

COMPENSATION TO BE PAID TO CONTRACTOR: The Owner agrees to pay and the Contractor agrees to accept in full consideration for the performance of the Contract, subject to additions and deductions as provided in the General Conditions, the sum of \$199,000.00. The sum is to be paid according to the schedule as provided in the General Conditions.

Pursuant to Labor Code, Section 1861, the Contractor gives the following certification: I am aware of the provisions of Section 3700 of the Labor Code which require every employer to be insured against liability for Worker's Compensation or to undertake self-insurance in accordance with the provisions of that code, and I will comply with such provisions before commencing the performance of the work of this Contract.

IN WITNESS WHEREOF, the parties hereto on the day and year first above written have executed this agreement in four (4) counterparts.

Type of Contractor's organization: S "B"
Corporation

If other than individual or corporation, list names of all members who have authority to bind firm.

Firm Name: Safeway Building Services, Inc. DBA: Safeway Security Systems
Address: 1474 N. Miller Dr, Colton / CA 92324
Contractor's License No.: 387886

IF OTHER THAN CORPORATION EXECUTE HERE

Signature: _____
Title: _____

Affix Seal
If
Corporation

IF CORPORATION, FILL OUT FOLLOWING AND EXECUTE

Name of President of Corporation: Daniel Scherneck

Name of Secretary of Corporation: Daniel Scherneck

Corporation is organized under the laws of State of California

Signature: _____
Title: President

Owner: COUNTY OF RIVERSIDE

Signature: _____
Title: Chairman - Board of Supervisors

Attest: Clerk - Board of Supervisors

By: _____
Title: _____

CONTRACTOR'S CERTIFICATE

REGARDING WORKERS' COMPENSATION

Labor Code Section 3700

Every employer, except the State and all political subdivisions or institutions thereof, shall secure the payment of compensation in one or more of the following ways:

- (a) By being insured against liability to pay compensation in one or more insurers duly authorized to write compensation insurance in this State.
- (b) By securing from the Director of Industrial Relations, a Certificate of Consent to Self-Insure, which may be given upon furnishing proof satisfactory to the Director of Industrial Relations of ability to self-insure and to pay any compensation that may become due to his employees

I am aware of the provisions of Section 3700 of the Labor Code which requires every employer to be insured against liability for Workers' Compensation or to undertake self-insurance in accordance with the provisions of that Code, and I will comply with such provisions before commencing the performance of this Contract.

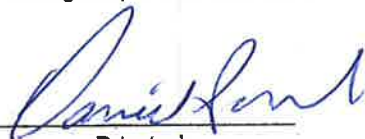

Principal

Daniel Scherneck

Principal

President

Title

(In accordance with Article 5 [commencing at Section 1860], Chapter, Part 7, Division 2 of the Labor Code, the above Certificate must be signed and filed with the Owner prior to performing any work under this Contract.)

Riverside County Inpatient Mental Health
Treatment Facility Camera
Project FM2008001851

9990 County Farm Rd. Riverside, CA 92503

Bid Opening June 24, 2010
10:00 am

SEALED BID RECEIVED
CLERK OF THE BOARD OF SUPERVISORS

RECEIVED RIVERSIDE COUNTY
CLERK / BOARD OF SUPERVISORS

2010 JUN 24 AM 9:15