

**SUBMITTAL TO THE BOARD OF SUPERVISORS  
COUNTY OF RIVERSIDE, STATE OF CALIFORNIA**

107A



**FROM:** TLMA - Transportation Department

**SUBMITTAL DATE:**  
March 8, 2012

**SUBJECT:** Skyview Road Reconstruction Project in the City of Jurupa Valley.

**RECOMMENDED MOTION:** That the Board of Supervisors:

1. Approve the plans and specifications for the reconstruction of a portion of Skyview Road in the City of Jurupa Valley.
2. Authorize the Clerk to advertise for bids to be received in the office of the Director of Transportation up to the hour of 2:00 pm, Wednesday, April 11, 2012 at which time bids will be opened.

Juan C. Perez  
Director of Transportation

JP:jrj:sb  
(Continued On Attached Page)

<b>FINANCIAL DATA</b>	Current F.Y. Total Cost:	\$ 270,000	In Current Year Budget:	Yes
	Current F.Y. Net County Cost:	\$ 0	Budget Adjustment:	No
	Annual Net County Cost:	\$ 0	For Fiscal Year:	2011/2012

<b>SOURCE OF FUNDS:</b> Proposition 1B (State bond funds-Local Roads) (100%)	<b>Positions To Be Deleted Per A-30</b>	<input type="checkbox"/>
	<b>Requires 4/5 Vote</b>	<input type="checkbox"/>

There are no General Funds used in this project.

**C.E.O. RECOMMENDATION:** APPROVE

BY:   
Tina Grande

**County Executive Office Signature**

**MINUTES OF THE BOARD OF SUPERVISORS**

On motion of Supervisor Stone, seconded by Supervisor Benoit and duly carried,  
**IT WAS ORDERED** that the above matter is approved as recommended.

**Ayes:** Buster, Stone, Benoit and Ashley  
**Nays:** None  
**Absent:** Tavaglione  
**Date:** March 20, 2012  
**xc:** Transp., COB

Kecia Harper-Ihem  
Clerk of the Board  
BY:   
Deputy

**Prev. Agn. Ref.** | **District:** 2<sup>nd</sup>/2<sup>nd</sup> | **Agenda Number:**

**3.20**

ATTACHMENTS FILED  
WITH THE CLERK OF THE BOARD

FORM APPROVED COUNTY COUNSEL  
BY:   
MARSHAL VICTOR  
DATE: 3/6/12  
Departmental Concurrence

Dept't Recomm.:  Consent  Policy  
Per Exec. Ofc.:  Consent  Policy

The Honorable Board of Supervisors

RE: Skyview Road Reconstruction Project in the City of Jurupa Valley.

March 8, 2012

Page 2 of 2

**BACKGROUND:** The Transportation Improvement Program provides for the reconstruction of a portion of Skyview Road that is now in the City of Jurupa Valley, Riverside County.

Skyview Road has been renamed and was the original Limonite Avenue. This road was constructed many years ago and portions of the road have subsided over time. The subsided areas have created dips and irregularities in the pavement surface. This project proposes to reconstruct 550 feet of pavement and resurface an additional 915 feet of pavement along Skyview Road at and near Peralta Place.

The County identified the need for pavement rehabilitation on Skyview Road, funds were budgeted and construction drawings were substantially prepared prior to incorporation of the City of Jurupa Valley. The Transportation Department is recommending that we complete delivery of this project.

The bid documents include the following schedules of work:

Base Bid: Primary items of work on Skyview Road.

Alternate 1: Utility repair and adjustment work funded by the Rubidoux Community Services District (RCSD).

Alternate 1 is intended to be awarded with the base bid contract. If utility repair and adjustment is required, the work can be done either by the RCSD or the Contractor. If the work is done by the Contractor, RCSD will be invoiced for completed work per Alternate 1.

The submitted plans and specifications have been approved as to form by County Counsel.

Environmental clearance is complete.

Project No. C2-0134

COUNTY OF RIVERSIDE  
DEPARTMENT OF TRANSPORTATION

SKYVIEW RD RESURFACING PROJECT  
FROM PERALTA PL TO SHARON WAY

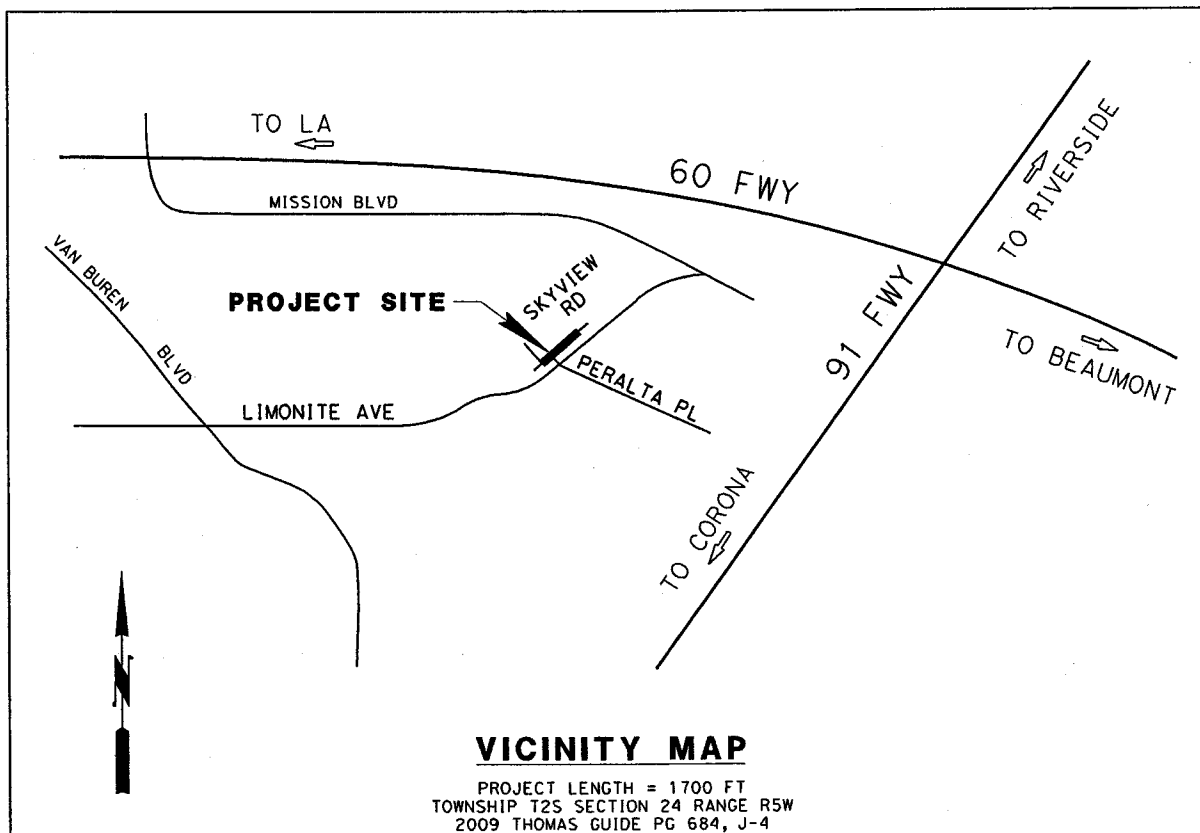
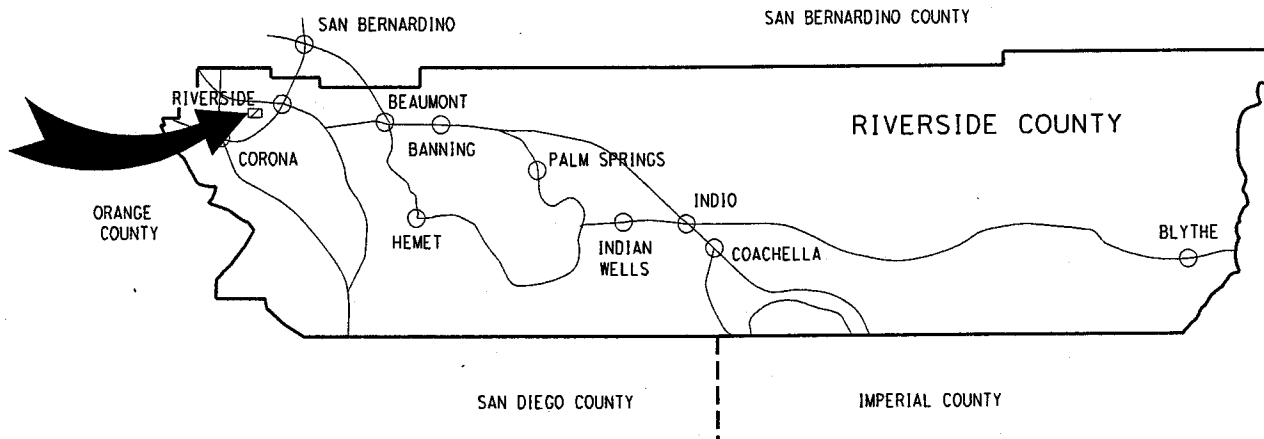

**Riverside County Board of Supervisors  
Request to Speak**

Submit request to Clerk of Board (right of podium),  
Speakers are entitled to three (3) minutes, subject  
Board Rules listed on the reverse side of this form.

**SPEAKER'S NAME:** REBECCA KUDWIG

**Address:** \_\_\_\_\_

(only if follow-up mail response requested)

**City:** \_\_\_\_\_

**Zip:** \_\_\_\_\_

**Phone #:** 951-784-0112

**Date:** 3-20-19

**Agenda #** 3.20

**PLEASE STATE YOUR POSITION BELOW:**

**Position on "Regular" (non-appealed) Agenda Item:**

\_\_\_\_\_ **Support**

**Oppose**

\_\_\_\_\_ **Neutral**

**Note:** If you are here for an agenda item that is filed  
for "Appeal", please state separately your position on  
the appeal below:

\_\_\_\_\_ **Support**

\_\_\_\_\_ **Oppose**

\_\_\_\_\_ **Neutral**

**I give my 3 minutes to:** \_\_\_\_\_





**SKYVIEW ROAD  
RECONSTRUCTION PROJECT  
CITY OF JURUPA VALLEY  
RIVERSIDE COUNTY**

**PROJECT NO. C1-0534**

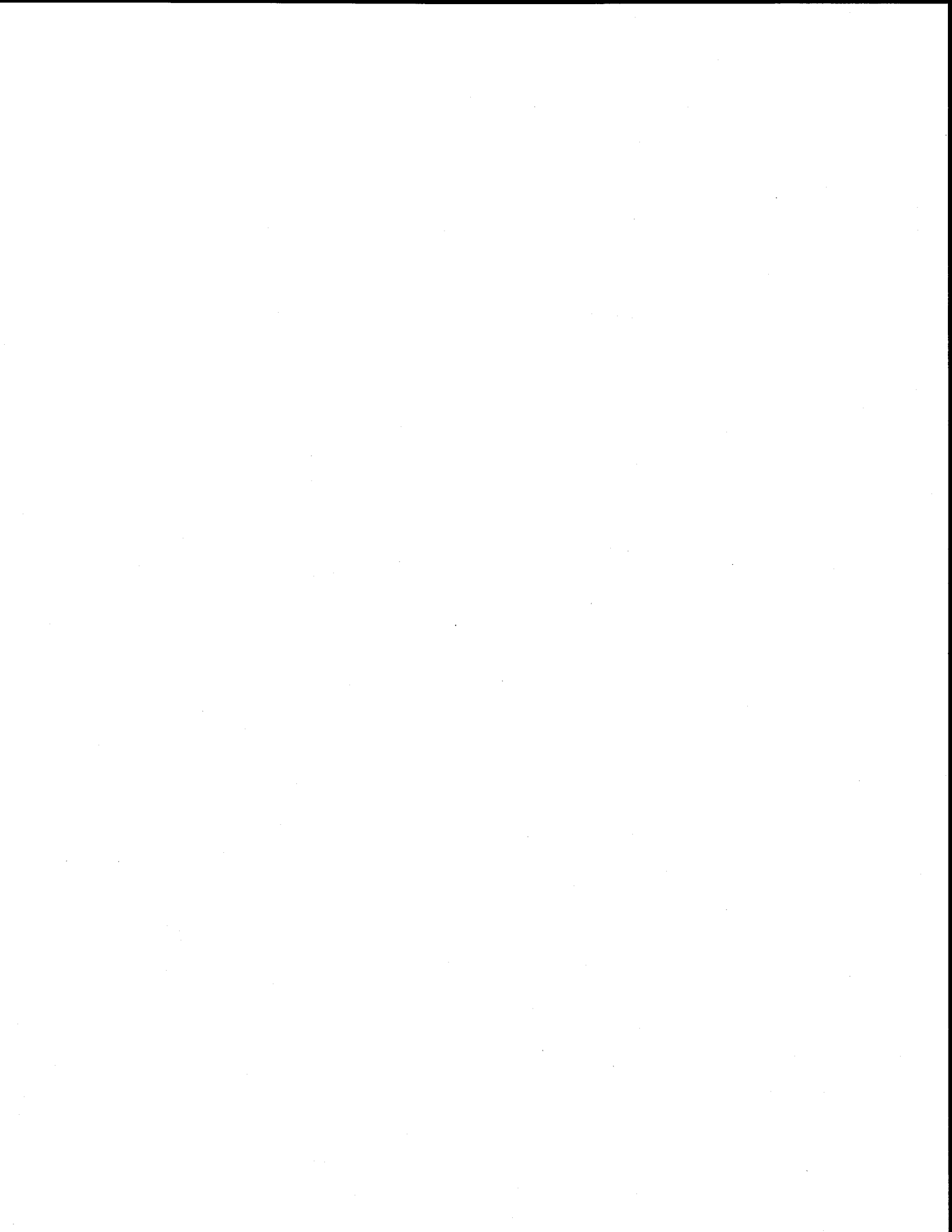



**SPECIFICATIONS AND CONTRACT DOCUMENTS**

for

**SKYVIEW ROAD  
RECONSTRUCTION PROJECT  
CITY OF JURUPA VALLEY  
RIVERSIDE COUNTY**

Project No. **C1-0534**

**Contract Approvals:**

Approved by:



Khalid Nasim,  
Engineering Division Manager

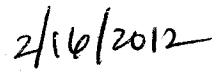

Date

**Engineering Certification:**

These specifications, special provisions, and estimates have been prepared by or under the direction of the following Registered Civil Engineers:



Michael O. Mueting,  
County Project Manager  
R.C.E. C 35165

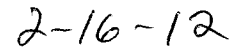

Date



**SPECIFICATIONS AND CONTRACT DOCUMENTS**

for

**SKYVIEW ROAD  
RECONSTRUCTION PROJECT  
CITY OF JURUPA VALLEY  
RIVERSIDE COUNTY**

Project No. **C1-0534**

**Water Pollution Control:**

**Reviewed and Recommended by:**

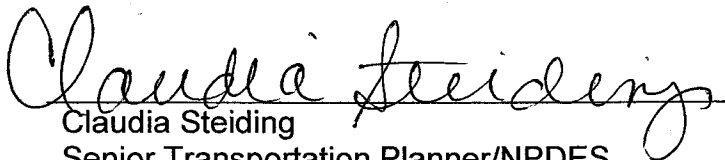

Claudia Steiding  
Senior Transportation Planner/NPDES  
Coordinator

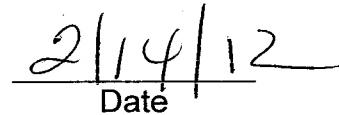

Date

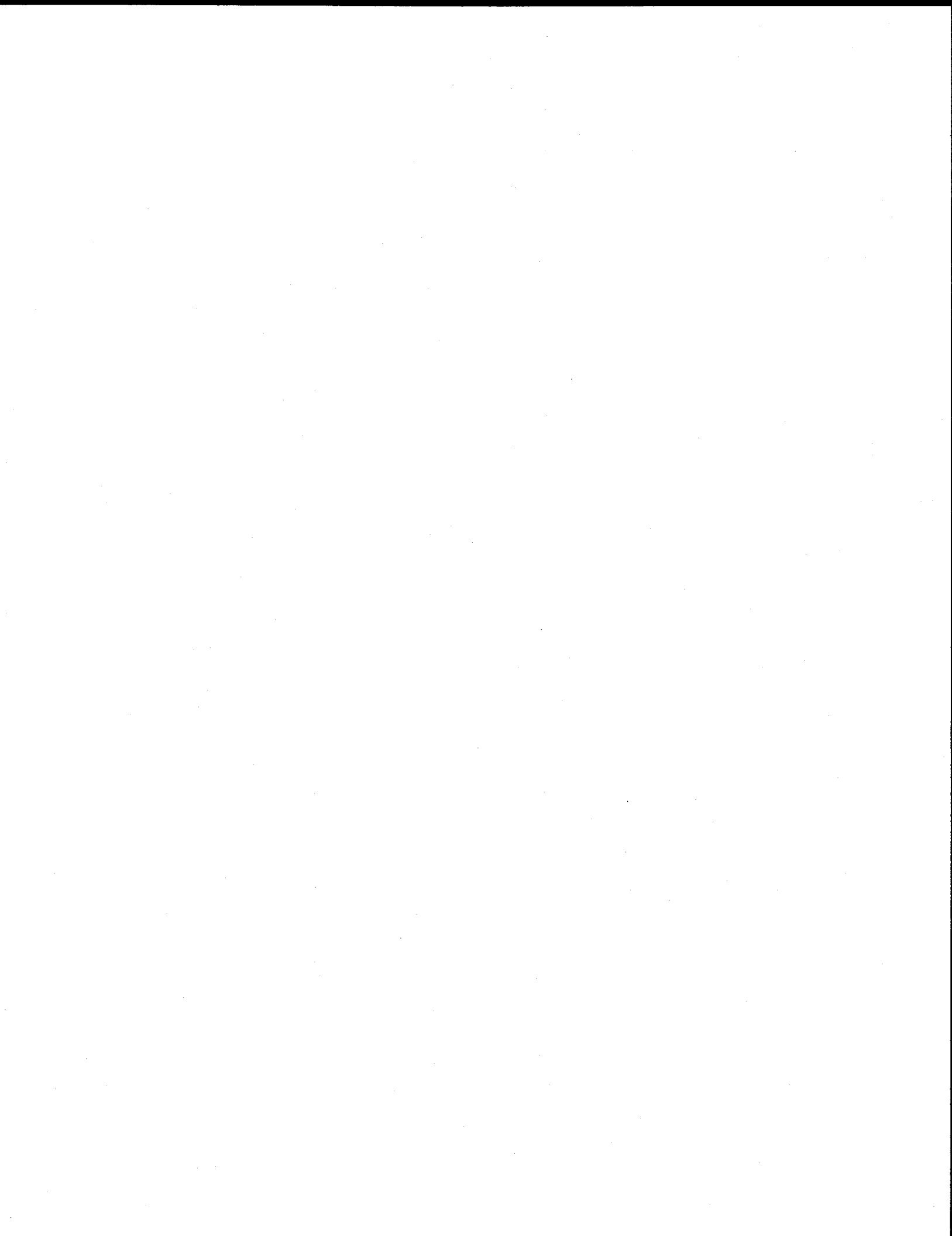

## TABLE OF CONTENTS

	<u>PAGE</u>
Notice Inviting Bids	
Instruction to Bidders	A1-A6
Contractor's Proposal	B1-B5
Non-Collusion Affidavit	B6
Bid Bond	B7
Agreement	C1-C3
Performance Bond	C4
Payment Bond	C5
General Conditions	1-21
Definitions	1
Standard Specifications	1
Director of Transportation	2
Site Inspection	3
Protection of Premises	4
Change Orders	5
Substitution of Equals	6
Final Inspection - Notice of Completion	7
Termination of Contracts	7
Payments and Monthly Estimates	8
Force Account Payment	9
Final Payment	10
Damages	10
Documents of Contractor	11
Responsibility of Contractor in Emergency	11
Labor Code	11
Obstructions	12
Insurance - Hold Harmless	12
Equal Employment Opportunity	15
Deposit of Securities	16
Assignment of Claims	17
Claims Resolution	17
Dust Abatement	18
AQMD Requirements	22-47
Special Provisions	48-83
Reference Drawings	

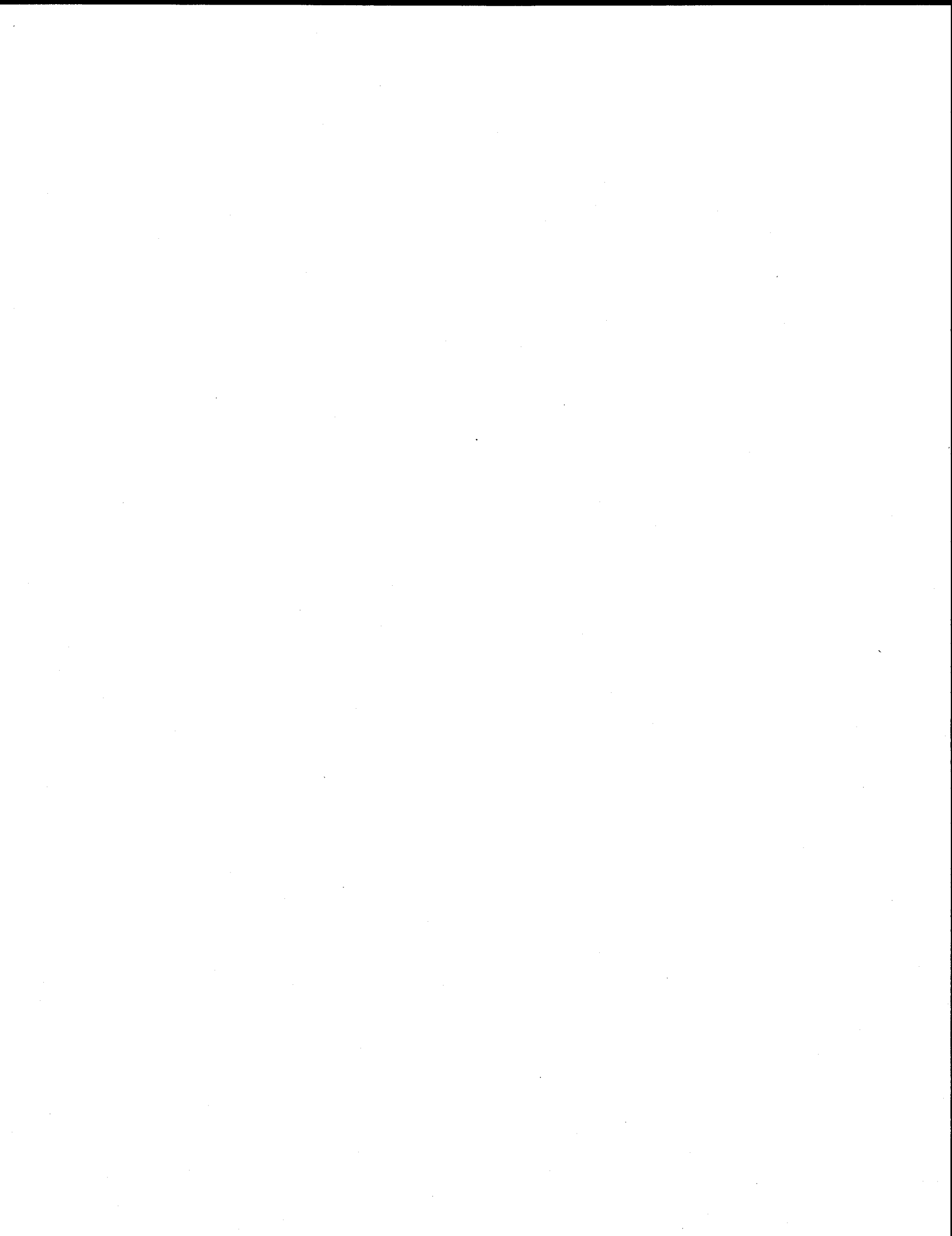

SPECIAL PROVISIONS .....	48
DESCRIPTION:.....	48
SPECIFICATIONS: .....	48
LIQUIDATED DAMAGES:.....	48
DISPOSAL OF EXCESS EXCAVATION OR MATERIALS: .....	49
PROJECT APPEARANCE:.....	49
RECORD DRAWINGS: .....	49
SURVEY STAKING: .....	50
OBTAIN ENCROACHMENT PERMIT:.....	50
ADDITIONAL INSURANCE-HOLD HARMLESS: .....	51
ITEMS OF WORK.....	52
PARTIAL PAYMENTS: .....	52
ORDER OF WORK: .....	52
COOPERATION:.....	53
OBSTRUCTIONS:.....	53
WATER POLLUTION CONTROL (SANTA ANA RIVER BASIN):.....	56
STREET SWEEPING:.....	59
TRAFFIC CONTROL SYSTEM/ PUBLIC CONVENIENCE/ PUBLIC SAFETY: .....	61
MAINTAINING TRAFFIC: .....	63
DEVELOP WATER SUPPLY: .....	64
CLEARING AND GRUBBING: .....	65
COLD PLANE ASPHALT CONCRETE PAVEMENT: .....	65
ROUT AND SEAL RANDOM CRACKS: .....	66
ROADWAY EXCAVATION:.....	67
AGGREGATE BASE: .....	68
HOT MIX ASPHALT:.....	69
COMPENSATION ADJUSTMENTS FOR PRICE INDEX FLUCTUATIONS: .....	76
ASPHALT CONCRETE DIKE AND OVERSIDE DRAIN: .....	77
PLACE ASPHALT CONCRETE (MISCELLANEOUS AREA): .....	78
ADJUST MANHOLE TO GRADE:.....	78
ADJUST SEWER CLEANOUT, WATER METER AND FIRE HYDRANT: .....	79
REPAIR SEWER AND WATER LATERAL: .....	79





RELOCATE MAIL BOX : ..... 79  
MASONRY BLOCK WALL (REMOVE/REPLACE): ..... 80  
CONCRETE CURB AND GUTTER, DRIVEWAY , DRIVEWAY APPROACH: ..... 80  
REMOVE TRAFFIC STRIPE AND PAVEMENT MARKING:..... 81  
FINISHING ROADWAY: ..... 82  
OBJECT MARKER: ..... 82  
PAINT TRAFFIC STRIPE: ..... 83  
THERMOPLASTIC PAVEMENT MARKING:..... 83



**NOTICE INVITING BIDS**

County of Riverside, herein called Owner, invites sealed proposals for:

**SKYVIEW ROAD  
RECONSTRUCTION PROJECT  
CITY OF JURUPA VALLEY  
RIVERSIDE COUNTY**

**PROJECT NO. C1-0534**

Proposal shall be delivered to the Riverside County Transportation Department, 14<sup>th</sup> Street Annex, 3525 14<sup>th</sup> Street, Riverside, California 92501, telephone (951) 955-6780 not later than 2:00 p.m., on Wednesday, April 11, 2012, to be promptly opened in public at said address. Each proposal shall be in accordance with plans, specifications, and other contract documents, dated February 2012, and prepared by County of Riverside, whose address is same as the above, from whom they may be obtained upon deposit of \$35 per set plus mailing. No refund. Prospective bidders may preview the plans, specifications and other contract documents, at no charge prior to purchase, at the above noted location.

The Contractor is required to have a Class "A" license or "C-12" license at the time of bid submission.

Dated: March 20, 2012

Kecia Harper-Ihem, Clerk of the Board

By: \_\_\_\_\_  
Deputy



## INSTRUCTIONS TO BIDDERS

1. Form of Proposal. The proposal must be made on the form of Contractor's Proposal which is included in the Contract Documents and must be completely filled in, dated and signed. If provision is made for alternates, they must all be bid, unless otherwise provided in the Special Provisions.
2. Bid Bond. The proposal must be accompanied by a 10% Bid Bond, using the form provided in the Contract Documents, or by a certified or cashier's check payable to the order of County in an amount not less than 10% of the amount bid, inclusive of alternates.
3. Submission of Proposal. A proposal must be submitted in a sealed opaque envelope which clearly identifies the bidder and the project. Bids must be received by the time and at the place set forth in the Notice Inviting Bids and may be withdrawn only as stated in the proposal. Bids shall be completed in ink.
4. Contract Documents. The complete Contract Documents are identified in the Agreement. Potential bidders are cautioned that the successful bidder incurs duties and obligations under all of the Contract Documents and that they should not merely examine the Plans and Specifications in making their bid.
5. License. To be considered for award of the contract, a potential bidder must have the kind of license required under provisions of the California Business and Professions Code for the work covered in this proposal. This includes joint ventures.

Each item of work will be performed by a Contractor which is qualified and properly licensed for that work.

Pursuant to California Labor Code Section 3099, certification is required for all persons who perform work as electricians for Contractors licensed as Class C-10 Electrical Contractors. Proof of certification shall be provided to the County before the start of construction.

6. Quantities. The amount of work to be done or materials to be furnished under the Contract as shown in the Contractor's Proposal are but estimates and are not to be taken as an expressed or an implied statement that the actual amount of work or materials will correspond to the estimate.

County reserves the right to increase or decrease or to entirely eliminate certain items from the work or materials to be furnished if such action is found to be desirable or expedient.

Contractor is cautioned against the unbalancing of his bid by prorating his overhead only into one or two items when there are a number of items listed in the schedule.

7. Interpretation of Documents. Discrepancies, omissions, ambiguities, requirements likely to cause disputes between trades and similar matter shall be promptly brought to the attention of the County of Riverside in writing. When appropriate, Addenda will be issued by County.

If the Bidder requires clarification or interpretation of the Bidding Documents, the Bidder shall make a written request to the County by a Request for Information (RFI). All requests for information must be submitted, in writing, between the hours of 8:00 AM and 5:00 PM on any day, Monday through Friday (except holidays), up to, including and no later than the fifth (5<sup>th</sup>) day prior to Bid Closing Deadline, by hand delivery, mail, fax or electronic mail. The County of Riverside will not respond to Requests for Information submitted after that time, unless the County determines, at its sole discretion, which it is in the best interest of the public and the County to do so. Requests for Information should be addressed to: County of Riverside, Transportation Department, Attn: Joel Jimenez; 3525 14<sup>th</sup> Street, Riverside, CA 92501, facsimile (951) 955-3164, electronic mail: [jrjimenez@rctlma.org](mailto:jrjimenez@rctlma.org)

No communication by anyone as to such matters except by an Addendum affects the meaning or requirements of the Contract Documents.

8. Addenda. County reserves the right to issue Addenda to the Contract Documents at any time prior to the time set to open bids. Each potential bidder shall leave with the County Transportation Department his name and address for the purpose of receiving Addenda to be mailed or delivered to such names at such addresses. To be considered, a Contractor's Proposal must list and take into account all issued Addenda.
9. Inspection of Site. Bidders must examine the site and acquaint themselves with all conditions affecting the work. By making his bid a bidder warrants that he has made such site examination as he deems necessary as to the condition of the site, its accessibility for materials, workmen and utilities and ability to protect existing surface and subsurface improvements. No claim for allowances - time or money - will be allowed as to such matters.
10. Bonds. The County requires a 100% Payment Bond and 100% Performance Bond from the successful bidder. All Bonds must be on County's forms contained in the Contract Documents.

The bonds must be underwritten by a Surety Company, which is admitted to transact the business of insurance in the State of California, and which carries a rating in the current issue of Best's Insurance Guide of "A" or better with a financial size of at least "VIII". The bond forms included in the project documents shall be used. All signatures on the bonds shall be notarized. Bonds shall be provided with an executed Power of Attorney issued by the surety.

11. Bids. Bids are required for the entire work, including all alternate bid schedules, if applicable, unless otherwise explicitly allowed in the bid documents. The amount of the bid for comparison purposes will be the total of all items. The total of unit basis items will be determined by extension of the item price bid on the basis of the estimated quantity set forth for the item.

The bidder shall set forth for each item of work in clearly legible figures, an item price and a total for the item in the respective spaces provided for this purpose. In the case of unit basis items, the amount set forth under the "Total" column shall be the extension of the item price bid on the basis of the estimated quantity for the item.

In case of discrepancy between the item price and the total set forth for the item, the item price shall prevail, provided, however, if the amount set forth as an item price is ambiguous, unintelligible or uncertain for any cause, or is omitted, or in the case of unit basis items, is the same amount as the entry in the "Total" column, then the amount set forth in the "Total" column for the item shall prevail in accordance with the following:

- a. As to lump sum items, the amount set forth in the "Total" column shall be the item price.
- b. As to unit basis items, the amount set forth in the "Total" column shall be divided by the estimated quantity for the item and the price thus obtained shall be the item price.

The bidder is advised that the items of work may be grouped into bid schedules, and that certain bid items may be listed in more than one bid schedule, and with different bid item numbers, and the following shall apply thereto:

The bidder is directed to submit the same bid amount for all contract bid items that are listed with the same item code and item description. Said bid items are referred to herein as "Like Bid Items".

"Like Bid Items" shall be considered a single bid item for purposes of calculating increased and decreased quantities, and as otherwise applicable in Section 4-1.03, "Changes" of the Standard Specifications.

The following are not subject to this bidding requirement:

1. Bid items with the same item code but different item descriptions.
2. Bid items that are measured as "lump sum" or "force account".
3. Alternate bid schedules.

In the event that a bidder submits different unit bid amounts for "Like Bid Items", as described above, the bid will be corrected by applying the lowest of the unit bid amounts to all the respective "Like Bid Items".

No bidder may withdraw his bid for a period of ninety (90) days after the bid opening.

12. Award of Contract. The County reserves the right to reject all bids received. Acceptance by the governing body of the County by resolution or minute order at a meeting regularly called

and held of a Contractor's Proposal constitutes an award of the contract and the execution of the Agreement is a written memorial thereof.

The County of Riverside will submit the contract documents to the low responsive and responsible bidder for execution prior to award utilizing the following procedures and requirements:

- a. A bidder whose proposal is accepted shall execute the formal construction agreement with the County of Riverside, similar to the form attached hereto as a sample, and shall return said agreement, together with approved performance and payment bonds and with complete evidence of insurance as required elsewhere herein, including executed additional insured endorsements and waivers of subrogation, within ten (10) working days from the date of the Notice of Acceptance of Proposal and Intent to Award as issued by the Transportation Department. All submittals shall meet the requirements of the bid documents. Corrections, if required, shall be made and the revised documents shall be resubmitted within two (2) working days of Contractor's receipt of review comments.
  - b. The contract bonds and insurance documentation shall be submitted in accordance with the contract requirements prior to submission to the County of Riverside Board of Supervisors for award by the Transportation Department, and prior to the performance of any work under the contract.
  - c. If a Bidder to whom a Notice of Acceptance of Proposal and Intent to Award has been issued, fails or refuses to sign a construction agreement, or to furnish the bonds or insurance certificates and endorsements as required within the prescribed period of time as described above, the County of Riverside may, at its sole discretion, rescind the Notice of Acceptance, and the bid guarantee submitted by that Contractor shall become the property of the County of Riverside as prescribed in the bid documents and as allowed by law.
  - d. If it is in the best interest of the County of Riverside, the County reserves the right to award the contract prior to execution by the Contractor. Thereafter, County shall mail or deliver to the lowest responsible bidder the agreement for Contractor's execution and return.
13. Return of Guarantee. Bid bonds will not be returned unless specifically requested by the bidder. Any submitted negotiable securities of unsuccessful bidders will be returned by mail within 30 days of the award of a contract to the successful bidder. Any submitted negotiable security of the successful bidder will be returned by mail within 30 days of receipt by the County of executed contract, certificate of insurance, performance bond and payment Bond.
14. Subletting and Subcontracting. Bidders are required pursuant to the Subletting and Subcontracting Fair Practices Act (commencing with Section 4100 of the Public Contracts Code) to list in their proposal the name and location of place of business of each subcontractor who will perform work or labor or render services in or about the construction



of the work or improvement or a subcontractor who specifically fabricates and installs a portion of the work or improvement according to detailed drawings contained in the Plans and Specifications in excess of 1/2 of 1% of this prime Contractor's total bid. Failure to list a subcontractor for a portion of the work means that the prime Contractor will do that portion of the work. It is the County's intent for the Subletting and Subcontracting Fair Practice Act to apply to all phases of the work.

15. Qualifications of Bidders. No award will be made to any bidder who cannot give satisfactory assurance to the Board of Supervisors as to his own ability to carry out the contract, both from his financial standing and by reason of his previous experience as a Contractor on work of the nature contemplated in the contract. The bidder may be required to submit his record of work of similar nature to that proposed under these specifications, and unfamiliarity with the type of work may be sufficient cause for rejection of bid.
16. Contract Participation. Riverside County's M/W/DVBE Contract Participation Program affirms the utilization and participation of qualified minority, women and disabled veteran firms in its contracting and procurement activities. The County encourages general and prime Contractors to afford competitive subcontracting opportunities to minority, women and disabled veteran firms where possible, in their contracting and procurement activities with the County of Riverside.
17. Hours of Work. Attention is directed to Section 8-1.06, "Time of Completion" and Section 7-1.01A (1), "Hours of Labor" of the Standard Specifications.

Daily working hours shall be between the hours of 7:00 a.m. and 6:00 p.m., Monday through Friday, except legal holidays, as approved by the Engineer. Exceptions and specific work schedules shall be submitted to the Engineer for consideration.

18. Labor Code. Pursuant to the Labor Code, the governing board of the Owner has obtained from the Director of the Department of Industrial Relations, State of California, his determinations of general prevailing rates of per diem wages applicable to the work, and for holiday, and overtime work, including employer payments for health and welfare, pensions, vacation and similar purpose, as set forth on schedule which is on file at the principal office of the Owner, and which will be made available to any interested person upon request.
19. Alternate Bid Schedules. If the Proposal includes bid items listed under a Base Bid Schedule and one or more Alternate Bid Schedules, the following shall apply: The County may award only the items of work listed on the Base Bid Schedule, or may choose to award some or all of the Alternate Bid Schedules in addition to the Base Bid Schedule. Unless otherwise specified, the basis of the selection of the lowest bid shall be the lowest responsive and responsible bid for the sum of all Bid Schedules.

If the Proposal includes bid items listed under two or more Alternate Bid Schedules with no Base Bid Schedule, the following shall apply: This project contains Alternate Bid Schedules that may or may not be mutually exclusive, as described elsewhere in the bid documents. The County may award the items of work listed on one or more of the Alternate Bid

Schedules. In the case of mutually exclusive Alternate Bid Schedules, only one of the Alternate Bid Schedules will be selected for award. Unless otherwise specified, the basis of the selection of the lowest bid shall be the lowest responsive and responsible bid for the sum of all Bid Schedules.

The County also reserves the right to reject all bids received.

20. Dust Abatement. Attention is directed to Section 23, "Dust Abatement" with regard to the dust abatement provisions of the contract.
21. Submission of Insurance Certificate. Within ten (10) working days of the date of the Notice of Acceptance of Proposal and Intent to Award issued by the County of Riverside, the successful Contractor shall submit a certificate of insurance, including required endorsements, which provides evidence that the bidding Contractor has insurance coverage that meets the requirements of Section 18 of the General Conditions. Failure to have complete insurance coverage in place and to provide all required certificates and endorsements within the specified ten (10) working days period will be grounds for declaring the bidder to not be in compliance with the bid documents, rescinding the Notice of Acceptance, making a claim against the bid bond, and awarding to the second low bidder, at the sole discretion of the County.

## CONTRACTOR'S PROPOSAL

TO: COUNTY OF RIVERSIDE

DATE: \_\_\_\_\_

hereafter called "County":

BIDDER: \_\_\_\_\_  
(hereafter called "Contractor")

THE UNDERSIGNED, Contractor, having carefully examined the site and the Contract Documents for the construction of SKYVIEW ROAD RECONSTRUCTION PROJECT, CITY OF JURUPA VALLEY, RIVERSIDE COUNTY, PROJECT No. C1-0534 hereby proposes to construct the work in accordance with the Contract Documents, including Addenda Nos. \_\_\_\_\_ for the amount stated in this Proposal.

By submitting this Proposal, Contractor agrees with County:

1. That unless withdrawn in person by Contractor or some person authorized in writing by Contractor not by telephone or telegram before the time specified in the Notice Inviting Bids for the public opening of bids, this Proposal constitutes an irrevocable offer for 90 calendar days after that date.
2. County has the right to reject any or all Proposals and to waive any irregularities or informalities contained in a Proposal.
3. To execute the Agreement and deliver the Faithful Performance Bond, Payment Bond and Insurance Certificate with endorsements, which comply with the requirements set forth in the Instructions to Bidders and General Conditions, within ten (10) working days of the date of the Notice of Acceptance of Proposal and Intent to Award as issued by the County of Riverside.
4. That the contract shall be awarded upon a resolution or minute order to that effect duly adopted by the governing body of County; and that execution of the Contract Documents shall constitute a written memorial thereof.
5. To submit to County such information as County may require to determine whether a particular Proposal is the lowest responsible bid submitted.

6. That the accompanying certified or cashier's check or Bid Bond is in an amount not less than 10% of the total bid submitted and constitutes a guarantee that if awarded the contract, Contractor will execute the Agreement and deliver the required bonds within ten (10) days after notice of award. If Contractor fails to execute and deliver said documents, the check or bond is to be charged with the costs of the resultant damages to County, including but not limited to publication costs, the difference in money between the amount bid and the amount in excess of the bid which it costs County to do or cause to be done the work involved, lease and rental costs, additional salaries and overhead, increased interest and costs of funding the project, attorney expense, additional engineering and architectural expense and cost of maintaining or constructing alternate facilities occasioned by the failure to execute and deliver said documents.
7. By signing this proposal the Contractor certifies that the representations made therein are made under penalty of perjury.

**SKYVIEW ROAD  
RECONSTRUCTION PROJECT  
CITY OF JURUPA VALLEY  
RIVERSIDE COUNTY**

**PROJECT NO. C1-0534**

**PROPOSAL**

ITEM No.	ITEM CODE	ITEM	UNIT	ESTIMATED QUANTITY	ITEM PRICE (IN FIGURES)	TOTAL (IN FIGURES)
<b>BASE BID</b>						
1	066102	DUST ABATEMENT	LS	1		
2	074020	WATER POLLUTION CONTROL	LS	1		
3	170101	DEVELOP WATER SUPPLY	LS	1		
4	120100	TRAFFIC CONTROL SYSTEM	LS	1		
5	160101	CLEARING AND GRUBBING	LS	1		
6	220101	FINISHING ROADWAY	LS	1		
7	152370	RELOCATE MAILBOX	EA	6		
8	153117	COLD PLANE ASPHALT CONCRETE PAVEMENT & BASE (.30' MAX)	SQYD	4,000		
9	190101	ROADWAY EXCAVATION	CY	800		
10	260201	CLASS 2 AGGREGATE BASE	CY	380		
11	390130	HOT MIX ASPHALT	TON	1,170		
12	394002	PLACE ASPHALT CONCRETE (MISCELLANEOUS AREA)	SQYD	250		
13	394048	PLACE ASPHALT CONCRETE DIKE (TYPE E)	LF	1,220		
14	013902	ASPHALT CONCRETE OVERSIDE DRAIN (CRS 306)	EA	1		
15	017305	MINOR CONCRETE (CURB AND GUTTER) (CRS 201)	LF	550		
16	017307	MINOR CONCRETE (TYPE "C" CURB) (CRS 202)	LF	550		
17	731516	MINOR CONCRETE (DRIVEWAY)	SQYD	60		
18	820151	OBJECT MARKER (TYPE L-1)	EA	3		
19	840515	THERMOPLASTIC PAVEMENT MARKING	SQFT	350		
20	840656	PAINT TRAFFIC STRIPE (2-COAT)	LF	3,000		
21	850102	PAVEMENT MARKER (REFLECTIVE)	EA	9		

PROJECT  
SUB-TOTAL:  
ITEMS 1-21

\$ \_\_\_\_\_

"WORDS"

ALTERNATE BID No. 1 - (Rubidoux Community Services District)

ITEM No.	ITEM CODE	ITEM	UNIT	ESTIMATED QUANTITY	ITEM PRICE (IN FIGURES)	TOTAL (IN FIGURES)
22	000003	REPAIR SHALLOW SEWER LATERAL (IF DAMAGED BY CONSTRUCTION)	EA	6		
23	000003	REPAIR SHALLOW WATER LATERAL (IF DAMAGED BY CONSTRUCTION)	EA	8		
24	152400	ADJUST SEWER CLEANOUT TO GRADE	EA	1		
25	152403	ADJUST WATER METER BOX TO GRADE	EA	6		
26	152427	ADJUST FIRE HYDRANT	EA	1		
27	152440	ADJUST MANHOLE TO GRADE	EA	1		

PROJECT SUB-TOTAL: \_\_\_\_\_ \$ \_\_\_\_\_  
 ITEM 22-27 "WORDS"

PROJECT TOTAL: \_\_\_\_\_ \$ \_\_\_\_\_  
 ITEMS 1-27 "WORDS"

**BIDDER DATA:**

Name of Bidder \_\_\_\_\_

Type of Organization \_\_\_\_\_

Person(s) Authorized to Sign for Bidder \_\_\_\_\_

Address \_\_\_\_\_

Phone \_\_\_\_\_

Contractor's License Type & Number \_\_\_\_\_

Expiration Date \_\_\_\_\_

8. **DESIGNATION OF SUBCONTRACTORS:** Contractor submits the following complete list of each subcontractor who will perform work or labor or render service in or about the construction in an amount in excess of 1/2 of 1% of the total bid.

<u>ITEM</u>	<u>SUBCONTRACTOR</u>	<u>ADDRESS</u>	<u>LICENSE NO.</u>
-------------	----------------------	----------------	--------------------

**Percent of work to be performed by sub-contractors: \_\_\_\_\_%**  
**(Note: 50% of the work required to be performed by general contractor)**

IN WITNESS WHEREOF Contractor executed this Proposal as of the date set forth on Page 1 of this proposal.

\_\_\_\_\_  
\_\_\_\_\_

TITLE \_\_\_\_\_  
"Contractor"

## Non-Collusion Declaration

To be executed by bidder and submitted with bid. (Public Contract Code Section 7106)

The undersigned declares:

I am the \_\_\_\_\_ (Title) of \_\_\_\_\_ (Company),  
the party making the foregoing bid.

The bid is not made in the interest of, or on behalf of, any undisclosed person, partnership, company, association, organization, or corporation. The bid is genuine and not collusive or sham. The bidder has not directly or indirectly induced or solicited any other bidder to put in a false or sham bid. The bidder has not directly or indirectly colluded, conspired, connived, or agreed with any bidder or anyone else to put in a sham bid, or that anyone shall refrain from bidding. The bidder has not in any manner, directly or indirectly, sought by agreement, communication, or conference with anyone to fix the bid price of the bidder or any other bidder, or to fix any overhead, profit, or cost element of the bid price, or of that of any other bidder.

All statements contained in the bid are true. The bidder has not, directly or indirectly, submitted his or her bid price of any breakdown thereof, or the contents thereof, or divulged information or data relative thereto, to any corporation, partnership, company, association, organization, bid depository, or to any member or agent thereof to effectuate a collusive or sham bid, and has not paid, and will not pay, any person or entity for such purpose.

Any person executing this declaration on behalf of a bidder that is a corporation, partnership, joint venture, limited liability company, limited liability partnership, or any other entity, hereby represents that he or she has full power to execute, and does execute, this declaration on behalf of the bidder.

I declare under penalty of perjury under the laws of the State of California that the foregoing is true and correct and that this declaration is executed on

\_\_\_\_\_ (Month) \_\_\_\_\_ (Day) of \_\_\_\_\_ (Year),

at \_\_\_\_\_ (City), California.

**Signature of Declarant:** \_\_\_\_\_

**Printed name of Declarant:** \_\_\_\_\_

**Name of Bidder (Company):** \_\_\_\_\_

**Title or Office:** \_\_\_\_\_

**Note:** Notarization of signature required.

Check box if attachment is included.



**Bid Bond**

**Recitals:**

1. \_\_\_\_\_ "Contractor", has submitted his/her Contractor's Proposal to County of Riverside, "County", for the construction of public work for **SKYVIEW ROAD RECONSTRUCTION PROJECT, CITY OF JURUPA VALLEY, RIVERSIDE COUNTY, PROJECT NO. C1-0534** in accordance with a Notice Inviting Bids from the County.
2. \_\_\_\_\_ a \_\_\_\_\_ corporation, hereafter called "Surety", is the surety of this bond.

**Agreement:**

We, Contractor as Principal and Surety as Surety, jointly and severally agree and state as follows:

1. The amount of the obligation of this bond is 10% of the amount of the Contractor's Proposal, including bid alternates, and inures to the benefit of County.
2. This Bond is exonerated by (1) County rejecting said Proposal or, in the alternate, (2) if said Proposal is accepted, Contractor executes the Agreement and furnishes the Bonds as agreed to in its Proposal, otherwise it remains in full force and effect for the recovery of loss, damage and expense of County resulting from failure of Contractor to act as agreed to in its Proposal. Some types of possible loss, damage and expense are specified in the Contractor's Proposal.
3. Surety, for value received, stipulates and agrees that its obligations hereunder shall in no way be impaired or affected by any extension of time within which County may accept the Proposal and waives notice of any such extension.
4. This Bond is binding on our heirs, executors, administrators, successors and assigns.

Dated: \_\_\_\_\_

Signatures:

\_\_\_\_\_

By: \_\_\_\_\_

By: \_\_\_\_\_

Title: Attorney in Fact  
"Surety"

Title: \_\_\_\_\_  
"Contractor"

STATE OF \_\_\_\_\_  
COUNTY OF \_\_\_\_\_

} ss. SURETY'S ACKNOWLEDGEMENT

On \_\_\_\_\_ before me, \_\_\_\_\_ personally appeared, \_\_\_\_\_ known to me, or proved to me on the basis of satisfactory evidence, to be the person whose name is subscribed to the within instrument and acknowledged to me that he/she executed the same in his/her authorized capacities, and that by his/her signature on the instrument the person, or the entity upon behalf of which the person acted, executed the instrument.

WITNESS my hand and official seal.

\_\_\_\_\_  
Signature of Notary Public

Notary Public (Seal)

**Note: This Bond must be executed by both Contractor and Surety with corporate seal affixed. All signatures must be notarized. (Attach acknowledgements).**

**AGREEMENT**

THIS AGREEMENT is entered into at Riverside, California as of the date set forth below is between County of Riverside hereafter called "County" and \_\_\_\_\_ hereafter called "Contractor".

WITNESSETH

RECITALS:

1. Contractor has submitted to County his Contractor's Proposal for the construction of County Project, \_\_\_\_\_ in strict accordance with the Contract Documents identified below and County has accepted said Proposal.
2. Contractor states that he has reexamined his Contractor's Proposal and found it to be correct, has ascertained that his subcontractors are properly licensed and possess the requisite skill and forces, has reexamined the site and Contract Documents and is of the opinion that he can presently do the work in accordance with the Contract Documents for the money set forth in his Proposal to be paid as provided in the Contract Documents.

AGREEMENT:

IT IS AGREED BY THE PARTIES AS FOLLOWS:

1. Contract Documents. The entire contract consists of the following: (a) The Agreement. (b) The Notice Inviting Bids. (c) The Instruction to Bidders. (d) The Contractor's Proposal. (e) The Bid Bond. (f) The Payment Bond. (g) The Performance Bond. (h) The General Conditions. (i) The Special Provisions. (j) The Standard Specifications of the State of California Department of Transportation edition of May 2006 as modified in other portions of the Contract Documents. (k) The Standard Plans of the Department of Transportation identified on the plans or in the Special Provisions. (l) The Plans. (m) Addenda No. \_\_\_\_\_. (n) The Determination of Prevailing Wage Rates for Public Work. (o) Any Change Orders issued. (p) Any additional or supplemental specifications, notice, instructions and drawings issued in accordance with the provisions of the Contract Documents. All of said Documents presently in existence are by this reference incorporated herein with like effect as if here set forth in full and upon the proper issuance of other documents they shall likewise be deemed incorporated. The Bid Bond is exonerated upon execution of this Agreement and the Payment Bond and Faithful Performance Bond.
2. The Work. Contractor shall do all things necessary to construct the work generally described in Recital No. 1 in accordance with the Contract Documents.

3. Liquidated Damages and Time of Completion. Attention is directed to the provisions in Section 8-1.06, "Time of Completion", and in Section 8-1.07, "Liquidated Damages", of the Standard Specifications and these Special Provisions.

The Contractor shall begin work within 15 days of the date stated within the written "Notice to Proceed".

The Contractor shall notify the Engineer, in writing, of his intent to begin work at least 72 hours before work is begun. The notice shall be delivered to the Transportation Department's Construction Engineer and shall specify the date the Contractor intends to start. If the project has more than one location of work, a separate notice shall be given for each location.

Should the Contractor begin work in advance of receiving a written "Notice to Proceed", any work performed by him in advance of the date stated in the "Notice to Proceed" shall be considered as having been done by him at his own risk and as a volunteer and subject to the following:

- (1) The Contractor shall, on commencing operations, take all precautions required for public safety and shall observe all the provisions in the Specifications and the Special Provisions.
  - (2) All work done according to the contract prior to the issuance of the "Notice to Proceed", will be considered authorized work and will be paid for as provided in the contract.
  - (3) The Contractor shall not be entitled to any additional compensation or an extension of time for any delay, hindrance or interference caused by or attributable to commencement of work prior to the issuance of the "Notice to Proceed".
4. Compensation. Contractor shall be paid in the manner set forth in the Contract Documents the amount of his Proposal as accepted by County, the above rates, subject to additions and deductions as provided in the Contract Documents. Said Proposal is on file in the Office of the Clerk of the Board of Supervisors of County.

IN WITNESS WHEREOF the parties hereto have executed this agreement as of the date set forth below.

COUNTY OF RIVERSIDE

CONTRACTOR

BY \_\_\_\_\_  
Chairman, Board of Supervisors

BY \_\_\_\_\_

Dated \_\_\_\_\_

TITLE: \_\_\_\_\_  
(If Corporation, Affix Seal)

ATTEST:

ATTEST:

Kecia Harper-Ihem, Clerk of the Board

\_\_\_\_\_

BY \_\_\_\_\_  
Deputy

TITLE: \_\_\_\_\_

Licensed in accordance with an act providing for the registration of Contractors,

License No. \_\_\_\_\_

Federal Employer Identification Number:

\_\_\_\_\_

\_\_\_\_\_  
"County"  
(Seal)

\_\_\_\_\_  
"Corporation"  
(Seal)

**PERFORMANCE BOND**

**Recitals:**

1. \_\_\_\_\_ (Contractor) intend to enter into an Agreement with COUNTY OF RIVERSIDE (County) for construction of public work known as \_\_\_\_\_.
2. \_\_\_\_\_, a \_\_\_\_\_ corporation (Surety), is the Surety under this Bond.

**Agreement:**

We, Contractor, as Principal, and Surety, as Surety, jointly and severally agree, state, and are bound unto County, as obligee, as follows:

1. The amount of the obligation of this Bond is 100% of the estimated contract price for the Project of \$ \_\_\_\_\_ and inures to the benefit of County.
2. This Bond is exonerated by Contractor doing all things to be kept and performed by it in strict conformance with the Contract Documents for the Project, otherwise it remains in full force and effect for the recovery of loss, damage and expense of County resulting from failure of Contractor to so act. All of said Contract Documents are incorporated herein.
3. This obligation is binding on our successors and assigns.
4. For value received, Surety stipulates and agrees that no change, time extension, prepayment to Contractor, alteration or addition to the terms and requirements of the Contract Documents or the work to be performed thereunder shall affect its obligations hereunder and waives notice as to such matters, except the total contract price cannot be increased by more than 10% without approval of Surety.

THIS BOND is executed as of \_\_\_\_\_.

By \_\_\_\_\_

By \_\_\_\_\_

By \_\_\_\_\_

Type Name \_\_\_\_\_

Its Attorney in Fact  
"Surety"

Title \_\_\_\_\_

"Contractor"

(Corporate Seal)

(Corporate Seal)

**NOTE: This Bond must be executed by both parties with corporate seal affixed. All signatures must be acknowledged. (Attach acknowledgements).**

**PAYMENT BOND**

(Public Work - Civil Code 3247 et seq.)

The makers of this Bond are \_\_\_\_\_, as Principal and Original Contractor and \_\_\_\_\_, a corporation, authorized to issue Surety Bonds in California, as Surety, and this Bond is issued in conjunction with that certain public works contract to be executed between Principal and COUNTY OF RIVERSIDE a public entity, as Owner, for \$ \_\_\_\_\_, the total amount payable. THE AMOUNT OF THIS BOND IS ONE HUNDRED PERCENT OF SAID SUM. Said contract is for public work generally consisting of \_\_\_\_\_.

The beneficiaries of this Bond are as is stated in 3248 of the Civil Code and requirements and conditions of this Bond are as is set forth in 3248, 3249, 3250 and 3252 of said code. Without notice, Surety consents to extension of time for performance, change in requirements, amount of compensation, or prepayment under said contract.

DATED: \_\_\_\_\_

\_\_\_\_\_  
Original Contractor - Principal

\_\_\_\_\_  
Surety

By \_\_\_\_\_

By \_\_\_\_\_  
Its Attorney In Fact

Title \_\_\_\_\_  
(If corporation, affix seal)

(Corporate Seal)

STATE OF CALIFORNIA }  
COUNTY OF \_\_\_\_\_ } ss. SURETY'S ACKNOWLEDGEMENT

On \_\_\_\_\_ before me, \_\_\_\_\_ personally appeared, \_\_\_\_\_, known to me, or proved to me on the basis of satisfactory evidence, to be the person whose name is subscribed to the within instrument and acknowledged to me that he/she executed the same in his/her authorized capacities, and that by his/her signature on the instrument the person, or the entity upon behalf of which the person acted, executed the instrument.

WITNESS my hand and official seal.

\_\_\_\_\_  
Signature of Notary Public

Notary Public (Seal)

**Note: This Bond must be executed by both parties with corporate seal affixed. All signatures must be notarized**

GENERAL CONDITIONS

SS 1. DEFINITIONS:

- a. "County", "Contractor", and "Contract Documents" are identified in the Agreement. "County" and "Contractor" includes their authorized representatives are treated throughout as if each were singular in number. "Contractor" includes its surety.
- b. "Engineer" and "Director of Transportation" means the Director of Transportation for the County of Riverside, and includes his authorized representatives.
- c. "Plans" means the portion of the Contract Documents consisting of all drawings prepared for the direction and characteristics of the work. A schedule of said drawings which constitutes the plans as of the execution of the Agreement is set forth in the Special Provisions and are supplemented by the Standard Plans referred to in the Special Provisions.
- d. "State of California", "Department of Transportation" and "Director of Transportation", means the County of Riverside.

SS 2. STANDARD SPECIFICATIONS:

The Standard Specifications of the State of California Department of Transportation, edition of May 2006 hereafter called "Standard Specifications", are incorporated herein as modified in these General Conditions, the Special Provisions and the Plans.

The following subsections of the Standard Specifications are deleted:

1-1.13, 1-1.15, 1-1.18, 1-1.25, 1-1.37, 1-1.40, 2-1.01, 2-1.05, 2-1.07, 5-1.14, 7-1.165, 8-1.03, 9-1.05, 9-1.065, 9-1.10, 12-2.02.

Section 3 of the Standard Specifications is deleted.

The following deletions and additions are made from the following subsections of the Standard Specifications.

Subsection 5-1.04, add to the second paragraph at its end the following sentence: "The General Conditions govern over

all of the Contract Documents except the Special Provisions, the Agreement and Bonds."

Subsection 7-1.01A (2), strike the last sentence of the second paragraph and in its place read: "These wage rates are on file in the Office of the County Clerk and are a part of the Contract."

Subsection 7-1.15, for "Director" read "Director of Transportation" except for last reference read "County of Riverside".

Subsection 7-1.16, delete references to Subsection 7-1.165.

Subsection 8-1.06, strike the last paragraph.

Subsection 8-1.08, strike "as provided in the State Contract Act".

SS 3. DIRECTOR OF TRANSPORTATION:

All work shall be done under the supervision of the Director of Transportation who shall determine the amount, quality, acceptability and fitness of all parts of the work, and interpret the Contract Documents. No act or omission of the Director of Transportation relieves Contractor of the duty to proceed with the work in strict conformity with the Contract Documents.

Upon request, Director of Transportation shall reduce to writing any oral order, objection, requirement or determination. Whenever Director of Transportation's approval is required it shall be in writing only.

All communications to County by Contractor shall be via Director of Transportation.

No work shall be performed on site other than during normal working hours without the knowledge and consent of Director of Transportation.

When in Director of Transportation's opinion, weather or other conditions are such that attempts to perform a portion of the work will probably result in work not in accordance with the Contract Documents, he shall so advise Contractor. When Contractor advises Director of Transportation that he intends to proceed despite such advise, he does so at his peril. The Director of Transportation may then order Contractor, in writing which specifies the portion of the work involved and the conditions warranting the issuance of the order, not to proceed on such portion of the work if (1) proceeding will in his judgment have an adverse effect on Contractor's



ability to complete the work within the stipulated time period, or (2) proceeding will in his judgment necessitate unusual tests and procedures to ascertain whether said portion of the work is in accordance with the Contract Documents. Contractor shall comply with such orders at its expense.

Nothing herein contained relieves Contractor from the duty to make independent determinations as to weather and other conditions affecting the proper completion of the work.

Failure for any reason of Director of Transportation to advise Contractor as to such matters, or to issue an order as above provided, does not relieve Contractor from the duty to accomplish the work in accordance with the Contract Documents.

As stated elsewhere, amounts shown in the Proposal and Agreement as to quantities are but estimates only. From time to time Director of Transportation shall direct Contractor as to the prosecution of the work in such a manner as to increase or decrease such estimates as to the work actually to be done. Contractor shall comply with such instructions and shall be paid only for work actually done based on the unit price set out in the Agreement.

SS 4. SITE INSPECTION - EFFECT OF OTHER IMPROVEMENTS SHOWN AND CONTRACTOR PROCEDURE:

Elsewhere in the Contract Documents reference may be made, graphically, descriptively or both, to the existence or possible existence of other improvements affecting the site and the prosecution of the work such as surface and subsurface utilities, drainage ditches and courses, buildings, fencing, retaining walls, roadways, curbs, trees, shrubs, and similar matters. Such matters are included to be used by Contractor to the extent he deems appropriate. However, it is expressly understood and agreed:

- a. Showing or describing such items does not mean that it is an exhaustive and complete presentation and that as to matters shown or described that they necessarily exist.
- b. All graphic presentations are schematic only unless the contrary is clearly set out elsewhere as to a particular matter.
- c. Whenever in the plans survey markers are shown, boundaries of the site are shown or contour lines are shown, Contractor may assume that such matters are shown in accordance with acceptable standards.

All improvements of the nature above described, whether elsewhere shown or described or not, shall, unless the contrary is elsewhere specifically directed, remain in place, undisturbed and suitably protected during the course of the work.

Whenever during the course of the work a subsurface improvement is discovered which Contractor believes is unknown to County, he shall immediately so inform Director of Transportation. Except as elsewhere provided, whenever in the course of the work it becomes apparent that the work cannot proceed without the destruction or relocation of any improvement, whether shown or described or not, Contractor shall immediately cease work affecting such improvements and notify Director of Transportation as to such circumstance and await instructions as to how to proceed.

- d. The Contractor shall be required to cooperate fully with all utility forces or forces of other public agencies engaged in relocation, lowering, altering or otherwise rearranging any facilities interfering with the progress of work or installing any facilities thereon.

The Contractor will also be required to cooperate fully with any County or State forces working on or near the project, or requiring access to the work in the performance of their duties.

SS 5. USE OF AND PROTECTION OF PREMISES AND REMOVAL OF DEBRIS:

At his expense Contractor shall:

- a. Take every precaution against injuries to persons or damage to property.
- b. Comply with regulations governing the use of the property.
- c. Store and suitably protect his apparatus, equipment, materials and supplies in an orderly fashion on site.
- d. Place on the work only such loads as are consistent with the safety of the work.
- e. Effect all cutting, fitting, or patching of his work required to make it conform to the Plans and Specifications and interrelate with other improvements or except with the consent of Director of

Transportation, cut or otherwise alter existing improvements.

- f. Protect and preserve established bench marks and monuments, make no changes in the location of such without the prior written approval of County, replace and relocate any of them which may be lost or destroyed or which require shifting because of necessary changes in grades or locations. All replacement and relocation work shall be accomplished only after approval of County and under the direct supervision and instruction of Director of Transportation.
- g. Before final payment remove all surplus materials, false work, temporary structures, debris, and similar matter resulting from his operations from the site and to put the site in an orderly condition.
- h. Construct, operate and maintain all passageways, guard fences, lights, barricades and other facilities required for protection by State or municipal laws and regulations and local conditions during the course of the work.
- i. Guard County's property from injury or loss.
- j. Take all reasonable precautions for dust and noise control and generally conduct operations so as not to constitute a nuisance.
- k. The Contractor shall be responsible for the protection of existing signs, fences, concrete curb and gutter and other highway facilities which may be encountered in the roadway. The replacement or repair of any facilities which the County deems necessary as a result of the Contractor's operations shall be done by the Contractor at his own expense and to the satisfaction of the County Transportation Department.

SS 6. CHANGE ORDERS - DETAIL DRAWINGS AND INSTRUCTIONS:

Reference is made to 4-1.03 and 4-1.03A of the Standard Specifications regarding change orders. Wherever in these subsections the word "Engineer" appears read "County".

Each approved change order shall be considered as an amendment to the Contract Documents and will not be considered approved until executed by the Board of Supervisors, except Director of Transportation can approve certain change orders without the necessity of approval by

the Board as provided in a Resolution of the Board adopted March 30, 1993, Resolution Number 93-047.

The above does not limit the ability of Director of Transportation to issue further detail drawings, explanations and instructions which are customarily given by an Engineer during the course of similar work. Director of Transportation will furnish Contractor with reasonable promptness such further detailed explanations, instructions and drawings as may be necessary for the proper execution of the work, and Contractor shall conform to same provided they are consistent with the intent of the Contract Documents. In giving such additional instructions, explanations and drawings Director of Transportation has authority to make minor changes in the work which do not involve extra cost and are not inconsistent with the Contract Documents.

Contractor's acting on such instructions, explanations and drawings of Director of Transportation means that Contractor agrees that such explanations, instructions and drawings are within the scope of the work in accordance with the intent of the Contract Documents and do not constitute a basis for modification of the Contract Documents as to price or time.

SS 7. BRAND OR TRADE NAME - SUBSTITUTE OF EQUALS:

Reference is made to Section 3400 of the Public Contracts Code, which is by this reference incorporated herein with like effect as if here set forth in full.

If a potential bidder believes he knows of an equal to a specified brand or trade name which is not mentioned in the Contract Documents, then such potential bidder may so advise Director of Transportation of such fact, giving all relevant information. If appropriate, an addendum will be issued as to the alleged equal provided that such issuance may be accomplished at least 5 days before the time fixed for opening bids.

Unless the subject article or product is expressly designated for matching others in use in a particular public improvement either completed or in the course of completion, any bidder may, as part of its bid proposal, include a request for substitution of an item equal to any specified by brand or trade name.

Within 35 calendar days after award of the contract, Contractor may submit to Director of Transportation data substantiating such a request, and the difference, if any, in cost. Director of Transportation shall promptly investigate the request and make a recommendation to County as to equality. The governing body of County shall promptly determine whether the substitute is equal in every respect

to the item specified, and approve or deny the request accordingly, and shall notify Director of Transportation of the determination made, who shall advise Contractor in writing of the decision. Unless the request is granted, substitution will not be permitted.

Nothing herein shall authorize a change in the contract price or prevent the use of change orders in the manner provided elsewhere in the Contract Documents.

SS 8. FINAL INSPECTION - NOTICE OF COMPLETION:

When the work is ready for final inspection County shall cause the work to be inspected and subjected to such tests as seem to it to be required for the purpose of determining if the work is complete in every respect.

At a meeting of the governing body of County held within 10 days after final inspection, the governing body shall consider the facts developed at the inspection. If it is found that the work is apparently complete in every respect, County will accept the work and a notice of completion will be recorded.

As between the parties, the recordation of the Notice of Completion, unless recorded because of a cessation of labor, means only that the time for final payment and the commencement of the guarantee period commences to run.

SS 9. COUNTY'S RIGHT TO STOP WORK OR TERMINATE THE CONTRACT:

(1) Contractor shall be adjudged bankrupt or make an assignment for the benefit of creditors, or (2) a receiver or liquidator is appointed for Contractor or any of his property, or (3) Contractor shall refuse or fail after Notice of Warning from County by Director of Transportation to supply sufficient properly skilled workmen or suitable materials, or (4) Contractor fails to prosecute the work with such diligence as will insure its completion within the stipulated time period, or (5) Contractor shall fail to make payments to persons supplying labor or materials for the work, or (6) Contractor does not comply with applicable law or instructions of Director of Transportation, or (7) Contractor is otherwise guilty of a substantial violation of any provision of the Contract Documents, then County without prejudice to such other and further right, remedy or relief it may be entitled to, may by 10 days notice to Contractor, terminate the employment of Contractor and his right to proceed, either as to the entire work, or at County's option, as to any portion thereof as to which delay shall have occurred or breach or miscompliance relates, and may thereupon take possession of the affected work and complete

the work by contract or otherwise, as County deems expedient. In such case Contractor shall not be entitled to receive any further payment until the work is finished. If the unpaid balance shall exceed the expense of completion, and other damage, expense or loss of County occasioned by Contractor's failure to properly perform, such excess shall be paid by Contractor. If such expense and damage exceeds the unpaid balance, Contractor is liable to County for the excess. If County elects to proceed under this Section, it may take possession of and utilize in completing the work such materials, supplies, plant and equipment on site which may be necessary or convenient for the purpose of completing the work, County is expressly granted the right - acting via Director of Transportation, an Engineer or otherwise - to operate equipment and machinery on site for the purpose of determining whether it has a basis for proceeding under this section.

If the construction of the project herein is damaged, which damage is determined to have been proximately caused by an act of God, in excess of 5% of the contract amount, provided that the work damaged is built in accordance with applicable building standards and the plans and specifications, then the Owner, upon certification by the Engineer, may, without prejudice to any other right of remedy, terminate the contract.

Decision by County not to proceed under this Section does not constitute a waiver by County of any right it might from time to time have against Contractor under the Contract Documents.

SS 10. PAYMENT AND MONTHLY ESTIMATES:

Director of Transportation, once each month, after said work is commenced and until after the completion and acceptance thereof, shall make and deliver to Contractor duplicate certificates stating the value of work then completed according to the contract, estimated according to the standard of the unit contract price, and thereupon Contractor shall be paid an amount sufficient with all previous payments to make the aggregate ninety five percent (95%) of the amount earned as certified. Maximum value of progress payment retention, as set forth in Section 9-1.06 of the Standard Specifications and any other referenced text, shall be five (5%).

The partial payments made as the work progresses will be payment on account on work performed as of the 25th of the month and shall in no way be considered as an acceptance of any part of the work or material of the contract, nor shall they in any way govern the final estimate. No such estimate or payment shall be made when in the judgement of the

Director of Transportation the total value of the work done since the last estimate amounts to less than \$300.

For the purpose of timely payment, the "receipt of payment request" date, as described in Public Contract Code 20104.50 and as referred to herein, shall be considered to be the fifth working day following the 25th day of each month.

Within 5 working days of the 25th day of each month the County shall:

- a. Calculate and prepare the certificate ("progress pay estimate") stating the value of the work completed for the billing month, for the purpose of determining the proper progress payment amount.
- b. If a progress pay estimate has been prepared by the County but has been contested by the Contractor as of the "receipt of payment request" date, as defined above, the County shall submit to the Contractor a document setting forth in writing a description of the dispute pertaining to the progress billing, and the County's reason for its position. Said document shall be submitted to the Contractor as soon as practicable, but not later than 7 calendar days after the "receipt of payment request" date.

Any progress pay estimate which is undisputed and remains unpaid for thirty (30) calendar days, after the "receipt of payment request date" shall accrue interest to the Contractor equivalent to the legal rate set forth in subdivision (a) of Section 685.010 of the California Code of Civil Procedure. The number of days available to the County to make a payment without incurring interest pursuant to this section shall be reduced by the number of days by which the County exceeds the seven-day submittal requirement set forth in the paragraph above.

Pursuant to Public Contract Code Section 20104.50, subsection (e), the progress payment date is the date that funds are encumbered and the payment warrant is issued.

SS 11. PAYMENT FOR EXTRA WORK (FORCE ACCOUNT BASIS):

Extra work to be paid for on a force account basis as directed by the Engineer will be paid for as set forth in Section 9-1.03 of the Standard Specifications. The labor surcharge, equipment rental rates and the right of way delay factors for each classification of equipment are listed in the Department of Transportation publication entitled Labor Surcharge and Equipment Rental Rates. A copy of which is on file at the Office of the Director of Transportation and is hereby incorporated herein in its entirety.

SS 12. FINAL PAYMENT:

Within thirty (30) days after the completion of the work and its acceptance by the Board of Supervisors, Director of Transportation will make a proposed final estimate in writing of the quantities of work done under the contract and the value of such work and will submit such estimate to Contractor. Within thirty (30) days thereafter Contractor shall submit to Director of Transportation his written approval of said proposed final estimate or a written statement of all claims which he has for additional compensation claimed to be due under the contract.

On Contractor's approval or if he files no claims within said period of thirty (30) days, Director of Transportation will issue a final written estimate as submitted to Contractor and County shall pay the entire sum so found to be due after deducting there from all previous payments and all amounts to be kept and all amounts to be retained under the provisions of the contract.

If Contractor within said period of thirty (30) days files claims, Director of Transportation will issue as a semi-final estimate the proposed estimate submitted to Contractor and the County will within thirty (30) days pay the sum found due thereon after deducting all prior payments and all amounts to be kept and retained under the provisions of the contract, Director of Transportation shall then consider and investigate Contractor's claims and shall make such revisions in the said estimate as he may find to be due, and shall then make and issue his final written estimate. County will pay the amount so found due after deducting all previous payments and amount to be retained under the contract.

All prior or partial estimates and payments shall be subjected to correction in the final estimate and payment.

The final estimate shall be conclusive and binding against both parties to the contract on all questions relating to the performance of the contract and the amount of work done there under and compensation therefore, except in the case of gross error. Acceptance of final payment constitutes a release of County by Contractor of all claims relating to the work.

SS 13. DAMAGES:

Contractor acknowledges that failure to perform in strict accordance with the Contract Documents will cause County to suffer special damages in addition to cost of completion of the work in accordance with the provisions of the Contract



Documents. Such special damage could include, but is not limited to, lease and rental cost, additional salaries and overhead, interest during construction, attorney expense, additional engineering, and inspection expense and cost of maintaining or constructing alternate facilities.

SS 14. DOCUMENTS OF CONTRACTOR:

Upon demand, Contractor shall make available to County all documents in its possession relevant to the work accomplished or to be accomplished or any demand or claim of Contractor as to County. This includes copies of documents sent by Contractor or others in its possession. Contractor shall further make available to County conformed copies of all documents submitted to the sureties who executed the Bid Bond, Faithful Performance Bond or Payment Bond for the purpose of obtaining the sureties' signature, including any guarantee or indemnification made to such surety by others for such purpose. Contractor shall maintain in his possession all documents relative to the work for three years after Notice of Completion.

SS 15. RESPONSIBILITY OF CONTRACTOR TO ACT IN AN EMERGENCY:

In case of an emergency which threatens loss or injury to property or life, Contractor shall act without previous instructions as the situation may warrant. Contractor shall notify Director of Transportation immediately thereafter. Any compensation claimed by Contractor, together with substantiating documentation shall be submitted to County via Director of Transportation.

SS 16. LABOR CODE:

Reference is made to Chapter 1, Part 7, Division 2 of the California Labor Code (commencing with Section 1720). By this reference said Chapter 1 is incorporated herein with like effect as if it were here set forth in full. The parties recognize that said Chapter 1 deals, among other things with discrimination, penalties and forfeitures, their disposition and enforcement, wages, working hours, and securing worker's compensation insurance and directly effect the method of prosecution of the work by Contractor and subject it under certain conditions to penalties and forfeitures. Execution of the Agreement by the parties constitutes their agreement to abide by said Chapter 1, their stipulation as to all matters which they are required to stipulate as to by the provisions of said Chapter 1, constitutes Contractor's certification that he is aware of the provisions of said Chapter 1 and will comply with them and further constitutes Contractor's certification as

follows: "I am aware of the provisions of Section 3700 of the California Labor Code which require every employer to be insured against liability for worker's compensation or to undertake self-insurance in accordance with the provisions of that Code, and I will comply with such provisions before commencing the performance of the work of this contract." Contractor and his subcontractors shall comply with the provisions of SS 1777.5 of the Labor Code regarding apprentices.

Contractor shall post at each job site during the course of the work a copy of County's "Determination of Prevailing Wage Rates", copies of said Determination are available from County for this purpose.

SS 17. OBSTRUCTIONS:

Attention is directed to Sections 8-1.10, "Utility and Non-Highway Facilities" and 15, "Existing Highway Facilities" of the Standard Specifications and these Special Provisions.

Add the following to the fourth paragraph of Section 8-1.10, "Utility and Non-Highway Facilities", of the Standard Specifications is amended to read:

In the event that the utility facilities mentioned above are not removed or relocated by the times specified and, if in the opinion of the Engineer, the Contractor's operations are delayed or interfered with by reason of the utility facilities not being removed or relocated by said times, the State will compensate the Contractor for such delays to the extent provided in Section 8-1.09, "Right of Way Delays" of the Standard Specifications, and not otherwise, except as provided in Section 8-1.10, "Utility and Non-Highway Facilities" of the Standard Specifications.

SS 18. INSURANCE - HOLD HARMLESS:

In lieu of the provisions of Section 7-1.12 the following shall apply:

Contractor shall not commence work under this contract until he has obtained the insurance required hereunder and satisfactory proof of said insurance has been submitted to and approved by the County of Riverside.

Contractor shall submit to the County of Riverside a Certificate of Insurance, signed by an authorized representative of the Contractor's insurance provider or agency, which certifies to the County that insurance

coverage is provided in accordance with the requirements of this section. The Certificate of Insurance shall include as attachments the required "Waiver of Subrogation" and "Additional Insured" policy endorsements.

I. Workers Compensation Insurance:

Contractor shall procure and maintain during the life of the contract Worker's Compensation Insurance coverage as prescribed by the laws of the State of California. Policy shall include Employers' Liability including Occupational Disease with limits not less than \$1,000,000 per occurrence. Policy shall be endorsed to provide a Borrowed Servant Endorsement, Alternate Employer Endorsement, or Additional Insured Endorsement naming the County of Riverside, its Director's Officers, Special Districts, Board of Supervisors, employees, agents or representatives as Additional Insureds. Policy shall contain a Waiver of Subrogation in favor of the County of Riverside.

Contractor shall further require each of its subcontractors to procure Worker's Compensation Insurance as required by the State while working on the project and the Contractor shall require the subcontractors to endorse the policy to provide a Borrowed Servant Endorsement, Alternate Employer Endorsement, or Additional Insured Endorsement naming the County of Riverside, its Director's Officers, Special Districts, Board of Supervisors, employees, agents or representatives as Additional Insureds. Policy shall contain a Wavier of Subrogation in favor of the County of Riverside.

II. Comprehensive General Liability Insurance:

Contractor shall take out and maintain during the course of the work General Liability Insurance covering bodily injury and property damage insurance and blanket contractual coverage as to the work and obligations covered hereunder. The amount of the insurance shall be in an amount **not less than \$2,000,000**. The policy may be a combined single limit or split limits, but the amount must be no less than \$2,000,000 per occurrence. The insurance carrier must have a current rating of "A" or better by the A.M. Best Company, a financial size of at least "VIII", and be an admitted carrier in the State of California. Any exceptions must be approved in advance by the County of Riverside Risk Management. Said insurance must contain an endorsement the County of Riverside is named as an additional insured as respects the work covered hereunder and **said insurance must not**

contain, as respects the work covered hereunder, any exclusions as to bodily injury or death or property damage arising out of blasting, explosion, or underground damage to wire, pipes, conduits, mains, sewers, tank tunnels or any similar property - i.e. the so-called "x c u" exclusions. The insurance certificate evidencing such insurance must affirmatively state that the insurance carrier (s) will give Owner 30 days written notice prior to cancellation of the insurance or a reduction in coverage, and that "County of Riverside - its Director's Officers, Special Districts, Board of Supervisors, employees, agents and representatives" are named as Additional Insureds.

In the alternate to naming County of Riverside as additional insured, Contractor may take out and maintain during the course of the work and until acceptance by County, Owner's Protective Liability Insurance in an amount not less than \$2,000,000 covering Riverside County.

### III. Auto Liability:

If Lessee's vehicles or licensed mobile equipment will be on the premises or used in any manner on behalf of the County, then Lessee shall maintain auto liability insurance for all owned, non-owned or hired automobiles in an amount not less than \$1,000,000 per occurrence combined single limit. Policy shall name the "County of Riverside, its Director's Officers, Special Districts, Board of Supervisors, employees, agents, or representatives" as Additional Insureds.

### IV. Hold Harmless:

Contractor shall hold County of Riverside its officers, agent, and employees free and harmless from any liability whatsoever, including wrongful death, based or asserted upon any act or omission of Contractor, its officers, agents, employees or subcontractors relating to or in anywise connected with or arising from the accomplishment of the work, whether or not such acts or omissions were in furtherance of the work required by the Contract Documents and agrees to defend at his expense, including attorney fees, Owner, County of Riverside its officers, agents and employees in any legal action based upon any such alleged acts or omissions.

SS 19. EQUAL EMPLOYMENT OPPORTUNITY:

General:

Contractor shall not discriminate in its recruiting, hiring, promotion, demotion or termination practices on the basis of race, religious creed, color, national origin, ancestry, sex, age or physical handicap in the performance of this Contract shall comply with the provisions of the California Fair Employment Practice Act (commencing with SS 1410 of the Labor Code), the Federal Civil Rights Act of 1964 (P.L. 88-352) and all amendments thereto, Executive Order No. 11246 (30 Federal Register 12319), as amended, and all administrative rules and regulations issued pursuant to said Acts and Order. See particularly 41 Code of Federal Regulation (CFR) Chapter 60.

Contractor shall require each of its subcontractors to comply with the preceding paragraph and shall include in each subcontract language similar to the preceding paragraph.

Contractor shall permit access to its records of employment, employment advertisement, application forms and other pertinent data and records by Owner and any State or Federal agency having jurisdiction for the purpose of investigation to ascertain compliance with this Section.

Owner may assign an affirmative action representative to monitor Contractor and its subcontractor (s) conduct required by this Section, including the right of entry to the construction site for the purpose of obtaining information from persons performing work on the project providing such inspection does not interfere with the progress of the work.

Elsewhere in the Contract Documents specific requirements may be contained covering the same subject matter of this Section. If so, such specific requirements prevail over this Section in case of conflict.

Transactions of \$10,000 or Under:

Contracts and subcontracts not exceeding \$10,000 are exempt from the requirements of this Section. No Contractor or subcontractor shall procure supplies and/or services in less than usual quantities to avoid applicability of this Section. With respect to contracts and subcontractors for indefinite quantities, this Section applies unless the amount required in any one year under such contract will reasonably be expected not to exceed \$10,000.

Transactions in Excess of \$10,000, but Less Than \$50,000:

At Owner's request, Contractor shall certify that it has in effect an affirmative action plan and agrees to comply with all State and Federal laws and regulations regarding Fair Employment Practices. Contractor shall maintain a written copy of its affirmative action plan and furnish Owner a copy of the plan upon request. Owner may require Contractor to complete an Affirmative Action Compliance Report, on a form furnished by Owner, setting forth definite goals during the term of the Contract.

Transactions of \$50,000 or More:

If Contractor has fifty or more employees and a Contract for \$50,000 or more, it shall develop and submit to Owner, within thirty days after award, a written affirmative action compliance program providing in detail specific steps to guarantee equal employment opportunity. Contractor shall include in its affirmative action program a table of job classifications, which table shall include but need not be limited to job titles, duties, and rates of pay.

Contractor shall in each subcontract let to do a portion of the work covered hereunder, where the subcontractor involved has fifty or more employees and the subcontract is for \$50,000 or more, impose in the subcontract the above requirements.

For the purpose of determining the number of employees, the average of the Contractor's or its subcontractor's employees for the twelve month period immediately prior to award, or the total number of employees the Contractor or its subcontractor will have when performing this contract, whichever is higher, shall be used.

Federal Assisted Construction:

If this project is a Federally assisted construction project, then the contract provisions contained in 41 CFR SS 60-1.04 (b) are incorporated herein and the Contractor shall likewise incorporate said provisions in each subcontract entered by Contractor to perform the work. Federally assisted construction is identified as such in the Notice Inviting Bids.

SS 20. DEPOSIT OF SECURITIES:

In accordance with Public Contract Code Section 22300 and other applicable law, the Contractor may substitute securities for any moneys withheld to ensure performance under the contract.

SS 21. ASSIGNMENT OF CLAIMS:

In submitting a bid on this public works project, or any subcontractor agreeing to supply goods, services, or materials, and entering a contract pursuant thereto, the Contractor and/or subcontractor do offer and agree to assign to the Owner all rights, title, and interest in and to all causes of action it may have under Section 4 of the Clayton Act (15 U.S.C. Section 15) or under the Cartwright Act (Chapter 2 (commencing with Section 16700) of Part 2 of Division 7 of the Business and Professions Code), arising from purchases of goods, services, or materials pursuant to the public works contract or the subcontract. This assignment shall be made and become effective at the time the awarding body tenders final payment to the Contractor, without further acknowledgement by the parties.

SS 22. CLAIMS RESOLUTION:

In accordance with Public Contract Code Section 20104 - 20104.8 and other applicable law, public works claims of \$375,000 or less which arise between the Contractor and the Owner shall be resolved following the statutory procedure unless the Owner has elected to resolve the dispute pursuant to Public Contract Code SS 10240 et seq.

1. All claims shall be submitted in writing and accompanied by substantiating documentation. Claims must be filed on or before the date of final payment unless other notice requirements are provide in the contract. "Claim" means a separate demand by the claimant for (1) a time extension, (2) payment of money or damages arising from work done by or on behalf of the claimant and payment of which is not otherwise expressly provided for or the claimant is not otherwise entitled, or (3) an amount the payment of which is disputed by the Owner.

(a) Claims Under or equal to \$50,000. The Owner shall respond in writing to the claim within 45 days of receipt of the claim, or, the Owner may request, in writing, within 30 days of receipt of the claim, any additional documentation supporting the claim or relating to defenses or claims the Owner may have. If additional information is needed thereafter, it shall be provided upon mutual agreement of the Owner and the claimant. The Owner's written response shall be submitted 15 days after receiving the additional documentation, or within the same period of time taken by the

claimant to produce the additional information, whichever is greater.

- (b) Claims over \$50,000 but less than or equal to \$375,000. The Owner shall respond in writing within 60 days of receipt, or, may request in writing within 30 days of receipt of the claim, any additional documents supporting the claim or relating to defenses or claims the Owner may have against the claimant. If additional information is needed thereafter, it shall be provided pursuant to mutual agreement between the Owner and the claimant. The Owner's response shall be submitted within 30 days after receipt of the further documents, or within the same period of time taken by the claimant to produce the additional information or documents, whichever is greater.
2. If the claimant disputes the Owner's response, or if the Owner fails to respond within the statutory time period, the claimant may so notify the Owner within 15 days of the receipt of the response or the failure to respond, and demand an informal conference to meet and confer for settlement. Upon such demand, the Owner shall schedule a meet and confer conference within 30 days.
  3. If following the meet and confer conference, the claim or any portion thereof remains in dispute, the claimant may file a claim pursuant to Government Code SS 900 et seq. and Government Code SS 910 et seq. For purposes of those provisions, the time within which a claim must be filed shall be tolled from the time the claimant submits the written claim until the time the claim is denied, including any time utilized for the meet and confer conference.
  4. If a civil action is filed to resolve any claim, the provisions of Public Contract Code SS 20104.4 shall be followed, providing for non-binding mediation and judicial arbitration.

SS 23. DUST ABATEMENT:

Dust control shall conform to Section 10, "Dust Control", Section 7-1.01F, "Air Pollution Control", Section 17, "Watering", and Section 18, "Dust Palliative" of the Standard Specifications, Rules no. 401, 402, 403 and 403.1 of the South Coast Air Quality Management District (AQMD), Riverside County Code, Chapter 8.52, "Fugitive Dust Reduction Program For Coachella Valley", all other applicable Federal and State laws, and the requirements set forth herein.



The Contractor is cautioned that failure to control fugitive dust may result in fines being levied by the South Coast Air Quality Management District to both the Contractor and the County of Riverside, as owner. The Contractor shall be fully responsible for payment of all fines pertaining to air pollution control violations, resulting from Contractor's operations related to the construction contract, which may be levied against both the Contractor and the County of Riverside by the AQMD or other regulatory agencies. The Contractor's attention is directed to Section 7-1.01, "Laws to be Observed" of the Standard Specifications. The cost of all fines levied against the County of Riverside will be deducted from any moneys due or which may become due to the Contractor, unless other payment arrangements are made by the Contractor.

Dust control of all of the Contractor's operations is required 24 hours per day, 7 days a week for the duration of the contract, and until the disturbed soil is permanently stabilized. The Contractor shall take every precaution to prevent emissions of fugitive dust from the project site, from locations of stockpiled materials, from unpaved driving surfaces, from haul vehicles, from inactive construction areas, and from all other operations of the Contractor. The Contractor shall plan for and carry out proper and efficient measures to prevent his operations from producing dust in amounts damaging to property or which constitute a public nuisance, or which cause harm to persons living or working in the vicinity of the work. Of particular concern are emissions of PM10 particles, which are fine particulate matter of 10 microns or less and which are associated with sickness and death from respiratory disease.

The Contractor shall furnish and post dust mitigation signs, which shall be, at a minimum, in accordance with the "AQMD Signage Recommendations", attached hereto. Additional copies are available upon request from the Engineer. The sign shall include the Contractor's phone number which shall be maintained on a 24 hour basis. The sign message, size and design, including any deviations from the signage recommendations, shall be approved by the Engineer prior to fabrication.

The Contractor shall respond to complaints by mobilizing equipment and personnel at the construction site within 2 hours of each complaint to control fugitive dust.

Attention is directed to AQMD Rule 403.1, which applies to all contracts within the Coachella Valley Area of Riverside County. That AQMD Rule requires the Contractor to take specified dust control actions when prevailing wind speeds exceed 25 miles per hour. Wind forecasts, AQMD Rules and

other related information are provided by AQMD at 1-800-CUT-SMOG and at [www.aqmd.gov](http://www.aqmd.gov).

Any days on which the Contractor is prevented from working, due to the requirements of AQMD Rules, will be considered as non-working days, in accordance with Section 8-1.06, "Time of Completion" of the Standard Specifications.

The Contractor shall utilize the "Best Available Control Measures" of controlling fugitive dust, as prepared by the AQMD. For projects within the Coachella Valley, the "Reasonably Available Control Measures" may be employed, if effective within the context of the AQMD rules. However, if fugitive dust crosses the project boundary, more effective control measures, including the "Best Available Control Measures" shall be implemented.

A site-specific fugitive dust control plan shall be submitted to the Engineer for review and approval at least 10 days prior to the start of construction. Additionally, for projects outside of the Coachella Valley which meet the criteria for AQMD plan approval, the Contractor shall submit the dust control plan to AQMD for approval. AQMD plan submittal criteria is defined in AQMD Rule 403 as being for projects that will have disturbed surface area in excess of 100 acres, or for projects with a scope of work which requires the movement of more than 10,000 cubic yards of soil on each of any three working days.

A sample plan and other pertinent information is attached, and additional copies are available from the Engineer upon request. The fugitive dust control plan shall include the "Reasonably Available Control Measures" and "Best Available Control Measures" of controlling fugitive dust, as may be appropriate and necessary, including but not limited to watering, application of chemical dust suppressants, wind fencing, covering of haul vehicles, haul vehicle bed-liners, covering or chemically stabilizing stored materials, phased grading, planting of vegetation, the use of a 24 hour environmental observer, and track-out controls at locations where unpaved construction accesses intersect with paved roads. The use of chemical stabilizers, which are approved by all environmental regulatory agencies, and the use of reclaimed water is encouraged. If water is intended as a primary dust control tool, the dust control plan shall provide for at least one 2,000 gallon water truck for every 4 acres of disturbed soil, unless otherwise approved by the Engineer.

If the Construction Engineer determines that the project scope and the forecasted weather conditions are such that the Contractor's work is unlikely to be a source of dust emissions, the Construction Engineer has the authority to waive the requirements for submittal of a dust control plan

and for placement of the dust control signs described herein. However, the Contractors responsibilities for the control of fugitive dust and the other requirements of this section may not be waived.

A completion notice will not be filed, and the final payment will not be made to the Contractor until the areas of disturbed soil on the construction site, including roadway shoulders, are suitably stabilized for long term control of fugitive dust.

The successful Contractor shall attend an AQMD PM10 Dust Control Program training session, and furnish evidence of attendance to the Engineer. Attendance at AQMD training seminars can be scheduled through AQMD at 1-866-861-DUST (1-866-861-3878) or by email to [dustcontrol@aqmd.gov](mailto:dustcontrol@aqmd.gov). Current AQMD certification of previous attendance will be accepted.

At that training session, the successful Contractor will be furnished with the AQMD prepared Rule 403 and Rule 403.1 implementation handbooks, which include the "Best Available Control Measures" and "Reasonably Available Control Measures", and other associated information, including a listing of suggested dust control related devices, materials and chemicals.

The signature of the Contractor on the Proposal constitutes acknowledgement by the Contractor of the dust control requirements established by law and described herein, and the enforceability of those requirements.

When the contract includes a bid item for Dust Abatement, full compensation for conformance with these dust abatement requirements, including labor, equipment, materials, developing water supply and incidentals, shall be paid at the lump sum price for Dust Abatement, and no additional compensation will be allowed therefor.

When the contract does not include a bid item for Dust Abatement, full compensation for conformance with these dust abatement requirements, including labor, equipment, materials, developing water supply and incidentals, shall be considered as included in the various items of work, and no additional compensation will be allowed therefor.

## AQMD RECOMMENDATIONS

November, 2001

Plan holder shall post signage at specified locations on the subject property in accordance with the standards specified below. The exception to the standards is that all letters shall be 4 inches high, with the names and telephone numbers of appropriate contacts and services in bold print, as indicated in the standards. These signs shall also include the SCAQMD toll free complaint line 1-800-CUT-SMOG (1-800-288-7664) and the telephone number for the Environmental Observer. These signs shall be posted within 50 feet of the curb on all four (4) corners of the subject property.

For each Dust Control Plan aggregating less than, or equal to, ten (10) acres:

1. The applicant shall install a sign on such property which is visible to the public that meets the following requirements:
  - (a) Such sign shall measure at least four (4) feet wide by four (4) feet high and conform to the specifications in 1 (a) below.

For each Dust Control Plan aggregating over ten (10) acres:

2. The applicant shall install a sign on such property which is visible to the public that meets the following requirements:
  - (a) Such sign shall measure at least eight (8) feet wide by four (4) feet high and conform to the specifications in 1 (b) below.

### THE SIGN SHALL CONFORM TO THE FOLLOWING REQUIREMENTS:

1. The sign boards shall be constructed with materials capable of withstanding the environment in which they are placed.

(a) For 4' x 4' signs, the District recommends the following:

- I. 3/4" A/C laminated plywood board
- II. Two 4" x 4" posts
- III. The posts should be attached to the edges of the plywood board with at least 2 carriage bolts on each post.
- IV. The front surface of the sign board should be painted in the contrasting color of a white background with black lettering.

(b) For 4' x 8' signs, the District recommends the following:

- I. 1" A/C laminated plywood board
- II. Two 5" x 6" posts
- III. The posts should be attached to the 4' edges of the plywood board with at least 2 carriage bolts on each post.
- IV. The front surface of the sign board should be painted in the contrasting color of a white background with black lettering.

**2. The sign board shall be installed and maintained in a condition such that members of the public can easily view, access, and read the sign at all times until the expiration date of the Dust Control plan.**

(a) For 4' x 4' signs, the District recommends the following:

- I. The lower edge of the sign board should be mounted at least 2' above the existing ground surface to facilitate ease of viewing.
- II. The posts should be set in a hole at least 3' deep with concrete footings to preclude downing by high winds.
- III. On the construction site, the sign should be positioned such that nothing obstructs the public's view from the primary street access point.
- IV. For construction projects that are developed in phases, the sign should be moved to the area that is under active construction.
- V. In situations where all phases of the construction project are completed on a property prior to expiration of the Dust Control Plan, a written request for cancellation of the Dust Control Plan must be submitted to the Engineer.

(b) For 4' x 8' signs, the District recommends the following:

- I. The lower edge of the sign board should be mounted at least 2' above the existing ground surface to facilitate ease of viewing.
- II. The posts should be set in a hole at least 4' deep with concrete footings to preclude downing by high winds.
- III. On the construction site, the sign should be positioned such that nothing obstructs the public's view from the primary street access point.
- IV. For construction projects that are developed in phases, the sign should be moved to the area that is under active construction.
- V. In situations where all phases of the construction project are completed on a property prior to expiration of the Dust Control Plan, a written request for cancellation of the Dust Control Plan must be submitted to the Engineer.

**3. The sign board shall contain the following information:**

- (a) Project Name
- (b) Name of Prime Contractor
- (c) Phone Number of Contractor's Employee Responsible for Dust Control Matters
- (d) County designated phone number (to be provided by the Engineer)
- (e) South Coast Air Quality Management District Phone Number

4. The sign board shall be designed to the following alpha and numeric text dimensions (sign boards written in longhand are unacceptable).

(a) For a permittee subject to the 4' x 4' sign requirement, the District provides the following example: (as modified by the County of Riverside for use on County Public Works projects)

1" UPPERCASE Letters →	PROJECT NAME:		3 ½ " Title Case Bold Letters ←
1" UPPERCASE Letters →	CONTRACTOR		3 ½ " Title Case Bold Letters ←
1" Title Case Letters →	Contractor's Dust Control Phone #		3" Bold Numbers ←
1" Title Case Letters →	County of Riverside Phone #		3" Bold Numbers ←
1" Title Case Letters →	Phone Number:	<b>SCAQMD</b> <b>1-800-CUT-SMOG</b>	3 ½ " Bold Numbers ←

"Title Case" means the first letter of a word is capitalized and subsequent letters are lower case.

(b) For a permittee subject to the 4' x 8' sign requirement, the District provides the following example: (as modified by the County of Riverside)

2" UPPERCASE Letters	PROJECT NAME:		4" Title Case Bold Letters
2" UPPERCASE Letters	CONTRACTOR		4" Title Case Bold Letters
2" Title Case Letters	Contractor's Dust Control Phone #		4" Bold Numbers
2" Title Case Letters	County of Riverside Phone #	909-	4" Bold Numbers
2" Title Case Letters	Phone Number:	SCAQMD 1-800-CUT-SMOG	4 1/2" Bold Numbers
2" Title Case Letters	<b>COUNTY OF RIVERSIDE TRANSPORTATION DEPARTMENT</b>		

Section 1

Simplified Sample Site Plan

Existing Residential

Distance and location of nearest:

Residence \_\_\_\_\_

Business \_\_\_\_\_

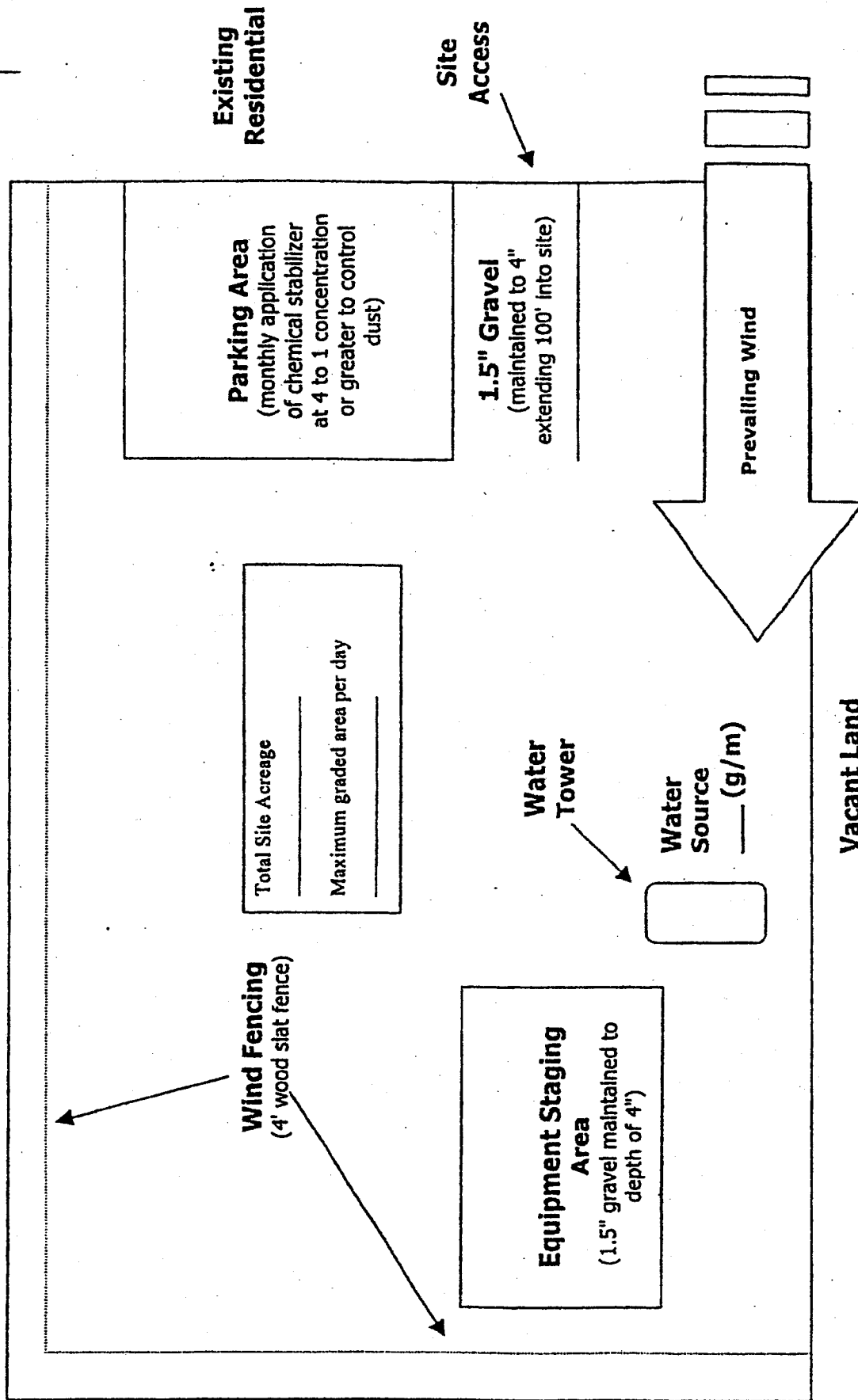
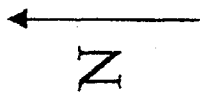

Existing Residential

Remember...  
**DUST CONTROL IS REQUIRED 24 HOURS A DAY, 7 DAYS A WEEK,  
 REGARDLESS OF CONSTRUCTION STATUS**



## Plan Review Checklist Clearing/Grubbing/Mass Grading Phase

- If feasible, use grading permit conditions to break the project into phases so that only a portion of the site is disturbed at any given time to ensure control of fugitive dust. This technique is critical for project sites with greater than 100 acres.
  
- Prior to initiating activity, pre-water site through use of portable irrigation lines. At least 72 hours of pre-watering is recommended for each area prior to initiating earth-movement. Require the Applicant to specify water source and available flow rate (g/m).
  
- Water applied continuously to all disturbed portions of the site by means of water truck/water pull as necessary to maintain sufficient visible moisture on the soil surface. For reference, one 2,000 gallon water truck can treat approximately 4 acres of active construction per hour. Also, for cut and fill activities, one 10,000 gallon water pull is estimated to be necessary for each 7,000 cubic yards of daily earth-movement. Multiple 4,000-gallon water trucks may be used in place of one 10,000-gallon water pull. Touch and visual contrast are reasonably good indicators of soil moisture. Surface areas that are dry to the touch and appear lighter-colored require the application of additional water to prevent visible or fugitive dust. Require the Applicant to specify the number of watering vehicles available for dust control during mass grading and during off-hours as well as availability of back-up water trucks if the site experiences dust control problems.
  
- Water towers are necessary for projects with more than 10 acres of active construction. Without a water tower, it can take up to 30 minutes to fill a 2,000 gallon water truck. Also, multiple water towers are necessary for projects that use water pulls as filling one 10,000 gallon water pull can drain a water tower which takes up to 40 minutes to refill.
  
- Wind fencing is necessary between the site and nearby residences or businesses. Off-site upwind fencing and on-site wind fencing for larger projects can also keep blowsand from being deposited onto the site or traveling through the site.
  
- A perimeter watering system consisting of portable irrigation equipment may be an effective mitigation system to protect surrounding residences and businesses. The portable watering system may be used in place of or in conjunction with watering trucks. The local jurisdiction may also be provided access to this equipment.

**Remember...**

**DUST CONTROL IS REQUIRED 24 HOURS A DAY, 7 DAYS A WEEK,  
REGARDLESS OF CONSTRUCTION STATUS**

- Construction site accesses are to be improved with 1.5" gravel maintained to a depth of 4" , at least 20' wide, and extending 100 feet into the site. If the project site is not balanced, a wheel washing system and/or ribbed steel plates should be placed in the roadway before the vehicle enters the graveled area to clean the tires and prevent trackout.
- Equipment staging areas are to be treated with 1.5" gravel maintained to a depth of 4".
- Employee parking areas are to be covered with 1.5" gravel maintained to a depth of 4" or treated with chemical dust suppressants at a 4 to 1 ratio on at least a monthly basis to prevent fugitive dust.
- Chemical dust suppressants are to be mixed at a ratio of 20 to 1 and applied to all disturbed surfaces that are proposed to remain inactive for a period of at least 10 consecutive days. These products are effective in preventing and controlling dust. Recordkeeping is necessary to demonstrate compliance.
- All project sites greater than 100 acres shall monitor daily wind speeds and AQMD forecasted wind events (call 1.800.CUT.SMOG, press one for air quality information, and then press five for Coachella Valley wind forecasts). Operators shall maintain these records for review by any local code enforcement officer or AQMD inspector.
- An environmental observer whose primary duty is to oversee dust control at the site is to be used for construction projects greater than 100 acres and/or sites with more than 50 acres of active construction. The environmental observer is tasked with monitoring dust abatement measures and authorized to deploy additional water trucks and other dust control actions (i.e., wind fencing, street sweepers, chemical dust suppressants, etc.) as necessary to prevent or control fugitive dust.
- Other (specify): \_\_\_\_\_  
 \_\_\_\_\_  
 \_\_\_\_\_  
 \_\_\_\_\_  
 \_\_\_\_\_  
 \_\_\_\_\_

**Remember...**  
**DUST CONTROL IS REQUIRED 24 HOURS A DAY, 7 DAYS A WEEK,**  
**REGARDLESS OF CONSTRUCTION STATUS**

## Plan Review Checklist Finish Grading Phase

- Water applied continuously to all disturbed portions of the site by means of water truck/water pull as necessary to maintain sufficient visible moisture on the soil surface. For reference, one 2,000 gallon water truck can treat approximately 4 acres of active construction per hour. Also, for cut and fill activities, one 10,000 gallon water pull is estimated to be necessary for each 7,000 cubic yards of daily earth-movement. Multiple 4,000-gallon water trucks may be used in place of a 10,000-gallon water pull. Touch and visual contrast are reasonably good indicators of soil moisture. Surface areas that are dry to the touch and appear lighter-colored require the application of additional water to prevent visible or fugitive dust. Require the Applicant to specify the number of watering vehicles available for dust control during finish grading and during off-hours as well as availability of back-up water trucks if the site experiences dust control problems.
  
- Water towers are necessary for projects with more than 10 acres of active construction. Without a water tower, it can take up to 30 minutes to fill a 2,000 gallon water truck. Also, multiple water towers are necessary for projects that use water pulls as filling one 10,000 gallon water pull can drain a water tower which takes up to 40 minutes to refill.
  
- Wind fencing is necessary between the site and nearby residences or businesses to reduce fugitive dust. Off-site upwind fencing and on-site wind fencing for larger projects can also keep blowsand from being deposited onto the site or traveling through a site.
  
- Chemical dust suppressants are to be applied at a concentration of at least 10 to 1 to finish graded areas once final elevations have been reached. For areas that will remain inactive for longer periods, vegetation can be a cost-effective alternative to chemical stabilization. Wind fencing or other obstructions can keep the stabilized area free from future disturbances.
  
- Construction site access(es) are to be improved with 1.5" gravel maintained to a depth of at least 4" with a minimum width of at least 20', extending 100 feet into the project site.
  
- Equipment staging areas are to be treated with 1.5" gravel maintained to a depth of 4".
  
- Internal roadway networks are to be treated with chemical dust suppressants at a minimum rate of at least 4 to 1 and retreated on a monthly basis once final roadway elevations have been reached.
  
- Employee parking areas are to be treated with chemical dust suppressants at a mix ratio of at least 4 to 1 and retreated on at least a monthly basis or covered with 1.5" gravel maintained to a depth of 4" to prevent fugitive dust.
  
- Other (specify): \_\_\_\_\_  
\_\_\_\_\_  
\_\_\_\_\_

**Remember...**  
**DUST CONTROL IS REQUIRED 24 HOURS A DAY, 7 DAYS A WEEK,**  
**REGARDLESS OF CONSTRUCTION STATUS**

## Plan Review Checklist Construction Phase

Water applied continuously to all disturbed portions of the site by means of water truck/water pull is necessary to maintain sufficient visible moisture on the soil surface. For reference, one 2,000 gallon water truck can treat approximately 4 acres of active construction per hour. Touch and visual contrast are reasonably good indicators of soil moisture. Surface areas that are dry to the touch and appear lighter-colored require the application of additional water to prevent visible or fugitive dust. Require the Applicant to specify the number of watering vehicles available for dust control during the construction phase and during off-hours as well as availability of back-up water trucks if the site experiences dust control problems.

Wind fencing is necessary between the site and nearby residences or businesses. Off-site upwind fencing and on-site wind fencing for larger projects can also keep blowsand from being deposited onto the site or traveling through the site. Block walls, if part of the final project, can replace wind fencing during the construction phase.

Chemical dust suppressants are to be applied at a concentration of at least 20 to 1 to finish graded areas once final elevations have been reached. For areas that will remain inactive for longer periods, vegetation can be a cost-effective alternative to chemical stabilization. Wind fencing or other obstructions can keep the stabilized area free from future disturbances.

Construction site accesses are to be improved with 1.5" gravel, maintained to a depth of 4", with a width of at least 20', extending 100' into the project site. Paving internal roadways can substitute for gravel.

Internal roadway networks are to be paved as early as feasible in the construction phase. Street sweeping of internal and/or external access roads will likely be required to control entrained road dust.

Employee parking areas are to be treated with chemical dust suppressants at a mix ratio of no less than 4 to 1 and retreated on a monthly basis, or more frequently if fugitive dust is observed. If internal roadway is complete, employees are to be instructed to park on paved roads.

Other (specify): \_\_\_\_\_  
\_\_\_\_\_  
\_\_\_\_\_  
\_\_\_\_\_  
\_\_\_\_\_

**Remember...  
DUST CONTROL IS REQUIRED 24 HOURS A DAY, 7 DAYS A WEEK,  
REGARDLESS OF CONSTRUCTION STATUS**

### REASONABLY AVAILABLE CONTROL MEASURES

Paragraph (d)(3) of Rule 403 allows activities outside the South Coast Air Basin (see Figure 2-1) to implement reasonably available control measures in lieu of best available control measures. Additionally, as specified by subparagraph (f)(3)(D) of Rule 403, any person seeking approval of a fugitive dust emissions control plan for projects outside the South Coast Air Basin must demonstrate to the satisfaction of the District that the given activity is employing all reasonably available fugitive dust control measures.

The District has prepared the attached listing of reasonably available fugitive dust control measures for a variety of source categories. This list is based on the U.S. Environmental Protection Agency's reference document entitled, "Control of Open Fugitive Dust Sources," Midwest Research Institute, September 1988.

The District encourages the use of those dust control measures that minimize the use of potable water. When water is needed, reclaimed water should be utilized to the greatest extent feasible.

**REASONABLY AVAILABLE CONTROL MEASURES**

The left column contains a listing of the sources of fugitive dust which are intended for emission control under District Rule 403 and a listing of control measures and high-wind measures. The right column contains a description of the reasonably available fugitive dust control measures for each of the sources.

Source: (1) Land Clearing/Earth-Moving

**CONTROL MEASURES**

(A) Watering

**DESCRIPTION**

- (1) Application of water by means of trucks, hoses and/or sprinklers prior to conducting any land clearing. This will increase the moisture content of the soils; thereby increasing its stability.
- (2) Pre-application of water to depths of proposed cuts.
- (3) Once the land clearing/earth moving activities are complete, a second application of water can generate a thin crust that stabilizes the disturbed surface area provided that it is not disturbed. (Security fencing can be used to prevent unwanted future disturbances of sites where a surface crust has been created).

(B) Chemical stabilizers

- (1) Only effective in areas which are not subject to daily disturbances.
- (2) Vendors can supply information on product application and required concentrations to meet the specifications established by the Rule.

(C) Wind fencing

- (1) Three- to five-foot barriers with 50% or less porosity located adjacent to roadways or urban areas can be effective in reducing the amount of windblown material leaving a site.
- (2) Would likely be used in conjunction with other measures (e.g., watering, chemical stabilization, etc.) to ensure that visible emissions do not cross a property line.

(D) Cover haul vehicles

- (1) Entire surface area of hauled earth should be covered once vehicle is full.

(E) Bedliners in haul vehicles

- (1) When feasible, use in bottom-dumping haul vehicles.

**HIGH WIND MEASURE**

- (a) Cease all active operations; or
- (b) Apply water within 15 minutes to any soil surface which is being moved or otherwise disturbed.

Source: (2) Unpaved Roads

**CONTROL MEASURES**

(F) Paving

(G) Chemical stabilization

**DESCRIPTION**

- (1) Requires street sweeping/cleaning if subject to material accumulation.
- (1) Vendors can supply information as to application methods and concentrations to meet the specifications established by the Rule
- (2) Not recommended for high volume or heavy equipment traffic use.

(H) Watering

- (1) In sufficient quantities to keep surface moist.
- (2) Required application frequency will vary according to soil type, weather conditions, and vehicular use.

(I) Reduce speed limits

- (1) 15 mile per hour maximum. May need to be used in conjunction with watering or chemical stabilization to prevent visible emissions from crossing the property line.

(J) Reduce vehicular trips

- (1) Access restriction or redirecting traffic to reduce vehicle trips by a minimum of 60 percent.

(K) Gravel

- (1) Gravel maintained to a depth of four inches can be an effective measure.
- (2) Should only be used in areas where paving, chemical stabilization or frequent watering is not feasible.

**HIGH WIND MEASURE**

- (c) Apply a chemical stabilizer (to meet the specifications established by the Rule) prior to wind events; or
- (d) Apply water once each hour; or
- (e) Stop all vehicular traffic.

# RULE 403 IMPLEMENTATION HANDBOOK

Source: (3) Storage Piles

## CONTROL MEASURES

### DESCRIPTION

- |  |  |
|--|--|
| (L) Wind sheltering                      | (1) Enclose in silos.<br>(2) Install three-sided barriers equal to height of material, with no more than 50 percent porosity.  |
| (M) Watering                             | (1) Application methods include: spray bars, hoses and water trucks.<br>(2) Frequency of application will vary on site-specific conditions.  |
| (N) Chemical stabilizers                 | (1) Best for use on storage piles subject to infrequent disturbances.  |
| (O) Altering load-in/load-out procedures | (1) Confine load-in/load-out procedures to leeward (downwind) side of the material.<br>(2) May need to be used in conjunction with wind sheltering to prevent visible emissions from crossing the property line. |
| (P) Coverings                            | (1) Tarps, plastic, or other material can be used as a temporary covering.<br>(2) When used, these should be anchored to prevent wind from removing coverings.   |

## HIGH WIND MEASURE

- (f) Apply chemical stabilizers (to meet the specifications established by the Rule) prior to wind events; or
- (g) Apply water once per hour; or
- (h) Install temporary covers.

January 1999



Source: (4) Paved Road Track-Out

**CONTROL MEASURES**

(Q) Chemical stabilization

**DESCRIPTION**

- (1) Most effective when used on areas where active operations have ceased.
- (2) Vendors can supply information on methods for application and required concentrations.

(R) Sweep/clean roadways

- (1) Either sweeping or water flushing may be used.

(S) Cover haul vehicles

- (1) Entire surface area should be covered once vehicle is full.

(T) Bedliners in haul vehicles

- (1) When feasible, use in bottom dumping vehicles.

(U) Site access improvement

- (1) Pave internal roadway system.
- (2) Most important segment, last 100 yards from the connection with paved public roads

**HIGH WIND MEASURE**

(i) Cover all haul vehicles; and

(j) Clean streets with water flushing, unless prohibited by the Regional Water Quality Control Board.

Source: (5) Disturbed Surface Areas/ Inactive Construction Sites

CONTROL MEASURES

DESCRIPTION

- (Q) Chemical stabilization
  - (1) Most effective when used on areas where active operations have ceased.
  - (2) Vendors can supply information on methods for application and required concentrations.
- (R) Watering
  - (1) Requires frequent applications unless a surface crust can be developed.
- (S) Wind fencing
  - (1) Three- to five-foot barriers with 50% or less porosity adjacent to roadways or urban areas can be effective in reducing the amount of wind blown material leaving a site.
- (T) Vegetation
  - (1) Establish as quickly as possible when active operations have ceased.
  - (2) Use of drought tolerant, native vegetation is encouraged.

HIGH WIND MEASURES

- (k) Apply chemical stabilizers (to meet the specifications established by the Rule); or
- (l) Apply water to all disturbed surface areas 3 times per day.

## BEST AVAILABLE CONTROL MEASURES

Rule 403, paragraph (d)(2) requires active operations [defined in Rule 403, paragraph (c)(1)] within the South Coast Air Basin (see Figure 2-1) to implement at least one best available control measure for each fugitive dust source type on site. Additionally, as specified by subparagraph (f)(3)(D) of Rule 403, any person seeking approval of a fugitive dust emissions control plan for projects within the South Coast Air Basin must demonstrate to the satisfaction of the AQMD that the given activity is employing all best available fugitive dust control measures.

The AQMD has prepared the attached listing of best available fugitive dust control measures for a variety of source categories. This list is based on the U.S. Environmental Protection Agency's reference document entitled, "Fugitive Dust Background Document and Technical Information Document for Best Available Control Measures," Office of Air and Radiation, September 1992.

The AQMD encourages the use of those dust control measures that minimize the use of potable water. When water is needed, reclaimed water should be utilized to the greatest extent feasible.

# RULE 403 IMPLEMENTATION HANDBOOK

## BEST AVAILABLE CONTROL MEASURES

The left column contains a listing of the sources of fugitive dust which are intended for emission control under District Rule 403 and a listing of control measures and high-wind measures. The right column contains a description of the best available fugitive dust control measures for each of the sources.

Source: (1) Land Clearing/Earth-Moving

### CONTROL MEASURES

### DESCRIPTION

- |                                |   |
|--------------------------------|---|
| (A) Watering (pre-grading)     | (1) Application of water by means of trucks, hoses and/or sprinklers prior to conducting any land clearing. This will increase the moisture content of the soils; thereby increasing its stability.   |
| (A-1) Watering (post-grading)  | (2) Pre-application of water to depths of proposed cuts.  |
| (A-2) Pre-grading planning     | (1) In active earth-moving areas water should be applied at sufficient frequency and quantity to prevent visible emissions from extending more than 100 feet from the point of origin.  |
| (B) Chemical stabilizers       | (1) Grade each phase separately, timed to coincide with construction phase; or<br>(2) Grade entire project, but apply chemical stabilizers or ground cover to graded areas where construction phase begins more than 60 days after grading phase ends.    |
| (C) Wind fencing               | (1) Only effective in areas which are not subject to daily disturbances.<br>(2) Vendors can supply information on product application and required concentrations to meet the specifications established by the Rule.                                     |
| (D) Cover haul vehicles        | (1) Three- to five-foot barriers with 50% or less porosity located adjacent to roadways or urban areas can be effective in reducing the amount of windblown material leaving a site. Must be implemented in conjunction with either measure (A-1) or (B). |
| (E) Bedliners in haul vehicles | (1) Entire surface area of hauled earth should be covered once vehicle is full.<br>(1) When feasible, use in bottom-dumping haul vehicles.  |

### HIGH WIND MEASURE

- (a) Cease all active operations; or
- (b) Apply water within 15 minutes to any soil surface which is being moved or otherwise disturbed.

## RULE 403 IMPLEMENTATION HANDBOOK

Source: (2) Unpaved Roads

### CONTROL MEASURES

### DESCRIPTION

- |                            |   |
|----------------------------|---|
| (F) Paving                 | (1) Requires street sweeping/cleaning if subject to material accumulation.  |
| (G) Chemical stabilization | (1) Vendors can supply information as to application methods and concentrations to meet the specifications established by the Rule<br>(2) Not recommended for high volume or heavy equipment traffic use. |
| (H) Watering               | (1) In sufficient quantities to keep surface moist.<br>(2) Required application frequency will vary according to soil type, weather conditions, and vehicular use.  |
| (I) Reduce speed limits    | (1) 15 mile per hour maximum. May need to be used in conjunction with watering or chemical stabilization to prevent visible emissions from crossing the property line.                                    |
| (J) Reduce vehicular trips | (1) Access restriction or redirecting traffic to reduce vehicle trips by a minimum of 60 percent.   |
| (K) Gravel                 | (1) Gravel maintained to a depth of four inches can be an effective measure.<br>(2) Should only be used in areas where paving, chemical stabilization or frequent watering is not feasible.               |

### HIGH WIND MEASURE

- (a) Apply a chemical stabilizer (to meet the specifications established by the Rule ) prior to wind events; or  
(b) Apply water once each hour; or  
(c) Stop all vehicular traffic.

# RULE 403 IMPLEMENTATION HANDBOOK

Source: (3) Storage Piles

## CONTROL MEASURES

## DESCRIPTION

- |  |  |
|--|--|
| (L) Wind sheltering                      | (1) Enclose in silos.<br>(2) Install three-sided barriers equal to height of material, with no more than 50 percent porosity.                                  |
| (M) Watering                             | (1) Application methods include: spray bars, hoses and water trucks.<br>(2) Frequency of application will vary on site-specific conditions.                    |
| (N) Chemical stabilizers                 | (1) Best for use on storage piles subject to infrequent disturbances.  |
| (O) Altering load-in/load-out procedures | (1) Confine load-in/load-out procedures to leeward (downwind) side of the material.<br>Must be used in conjunction with either measure (L), (M), (N), or (P).  |
| (P) Coverings                            | (1) Tarps, plastic, or other material can be used as a temporary covering.<br>(2) When used, these should be anchored to prevent wind from removing coverings. |

## HIGH WIND MEASURE

- (a) Apply chemical stabilizers (to meet the specifications established by the Rule) prior to wind events; or  
(b) Apply water once per hour; or  
(c) Install temporary covers.

**RULE 403 IMPLEMENTATION HANDBOOK**

---

Source: (4) Paved Road Track-Out

**CONTROL MEASURES**

**DESCRIPTION**

Compliance with District Rule 403.

Paragraph (d)(5).

## RULE 403 IMPLEMENTATION HANDBOOK

---

Source: (5) Disturbed Surface Areas/ Inactive Construction Sites

### CONTROL MEASURES

### DESCRIPTION

- (Q) Chemical stabilization
- (1) Most effective when used on areas where active operations have ceased.
- (2) Vendors can supply information on methods for application and required concentrations.
- (R) Watering
- (1) Requires frequent applications unless a surface crust can be developed.
- (S) Wind fencing
- (1) Three- to five-foot barriers with 50% or less porosity adjacent to roadways or urban areas can be effective in reducing the amount of wind blown material leaving a site. Must be used in conjunction with either measure (Q), (R), or (T).
- (T) Vegetation
- (1) Establish as quickly as possible when active operations have ceased.

### HIGH WIND MEASURES

- (a) Apply chemical stabilizers (to meet the specifications established by the Rule); or
- (b) Apply water to all disturbed surface areas 3 times per day.

---

\* Use of drought tolerant, native vegetation is encouraged.



**TABLE 1**

**BEST [REASONABLY] AVAILABLE CONTROL MEASURES FOR HIGH WIND CONDITIONS**

<b>FUGITIVE DUST SOURCE CATEGORY</b>	<b><u>CONTROL MEASURES</u></b>
<b>Earth-moving</b>	(1A) Cease all active operations; OR (2A) Apply water to soil not more than 15 minutes prior to moving such soil.
<b>Disturbed surface areas</b>	(0B) On the last day of active operations prior to a weekend, holiday, or any other period when active operations will not occur for not more than four consecutive days: apply water with a mixture of chemical stabilizer diluted to not less than 1/20 of the concentration required to maintain a stabilized surface for a period of six months; OR (1B) Apply chemical stabilizers prior to wind event; OR (2B) Apply water to all unstabilized disturbed areas 3 times per day. If there is any evidence of wind driven fugitive dust, watering frequency is increased to a minimum of four times per day; OR (3B) Take the actions specified in Table 2, Item (3c); OR (4B) Utilize any combination of control actions (1B), (2B), and (3B) such that, in total, these actions apply to all disturbed surface areas.
<b>Unpaved roads</b>	(1C) Apply chemical stabilizers prior to wind event; OR (2C) Apply water twice [once] per hour during active operation; OR (3C) Stop all vehicular traffic.
<b>Open storage piles</b>	(1D) Apply water twice [once] per hour; OR (2D) Install temporary coverings.
<b>Paved road track-out</b>	(1E) Cover all haul vehicles; OR (2E) Comply with the vehicle freeboard requirements of Section 23114 of the California Vehicle Code for both public and private roads.
<b>All Categories</b>	(1F) Any other control measures approved by the Executive Officer and the U.S. EPA as equivalent to the methods specified in Table 1 may be used.

\* Measures in [brackets] are reasonably available control measures and only apply to sources not within the South Coast Air Basin.

January 1999

**TABLE 2**  
**DUST CONTROL ACTIONS FOR EXEMPTION FROM PARAGRAPH (d)(4)\***

<b><u>FUGITIVE DUST SOURCE CATEGORY</u></b>	<b><u>CONTROL ACTIONS</u></b>
<b>Earth-moving (except construction cutting and filling areas, and mining operations)</b>	<p>(1a) Maintain soil moisture content at a minimum of 12 percent, as determined by ASTM method D-2216, or other equivalent method approved by the Executive Officer, the California Air Resources Board, and the U.S. EPA. Two soil moisture evaluations must be conducted during the first three hours of active operations during a calendar day, and two such evaluations each subsequent four-hour period of active operations;  OR</p> <p>(1a-1) For any earth-moving which is more than 100 feet from all property lines, conduct watering as necessary to prevent visible dust emissions from exceeding 100 feet in length in any direction.</p>
<b>Earth-moving: Construction fill areas:</b>	<p>(1b) Maintain soil moisture content at a minimum of 12 percent, as determined by ASTM method D-2216, or other equivalent method approved by the Executive Officer, the California Air Resources Board, and the U.S. EPA. For areas which have an optimum moisture content for compaction of less than 12 percent, as determined by ASTM Method 1557 or other equivalent method approved by the Executive Officer and the California Air Resources Board and the U.S. EPA, complete the compaction process as expeditiously as possible after achieving at least 70 percent of the optimum soil moisture content. Two soil moisture evaluations must be conducted during the first three hours of active operations during a calendar day, and two such evaluations during each subsequent four-hour period of active operations.</p>

\* Measures in [brackets] are reasonably available control measures and only apply to sources not within the South Coast Air Basin.

TABLE 2 (Continued)

<b>FUGITIVE DUST SOURCE CATEGORY</b>	<b>CONTROL ACTIONS</b>
<b>Earth-moving: Construction cut areas and mining operations:</b>	(1c) Conduct watering as necessary to prevent visible emissions from extending more than 100 feet beyond the active cut or mining area unless the area is inaccessible to watering vehicles due to slope conditions or other safety factors.
<b>Disturbed surface areas (except completed grading areas)</b>	(2a/b) Apply dust suppression in sufficient quantity and frequency to maintain a stabilized surface. Any areas which cannot be stabilized, as evidenced by wind driven fugitive dust must have an application of water at least twice per day to at least 80 [70] percent of the unstabilized area.
<b>Disturbed surface areas: Completed grading areas</b>	(2c) Apply chemical stabilizers within five working days of grading completion; OR  (2d) Take actions (3a) or (3c) specified for inactive disturbed surface areas.
<b>Inactive disturbed surface areas</b>	(3a). Apply water to at least 80 [70] percent of all inactive disturbed surface areas on a daily basis when there is evidence of wind driven fugitive dust, excluding any areas which are inaccessible to watering vehicles due to excessive slope or other safety conditions; OR  (3b) Apply dust suppressants in sufficient quantity and frequency to maintain a stabilized surface; OR  (3c) Establish a vegetative ground cover within 21 [30] days after active operations have ceased. Ground cover must be of sufficient density to expose less than 30 percent of unstabilized ground within 90 days of planting, and at all times thereafter; OR  (3d) Utilize any combination of control actions (3a), (3b), and (3c) such that, in total, these actions apply to all inactive disturbed surface areas.

\* Measures in [brackets] are reasonably available control measures and only apply to sources not within the South Coast Air Basin.

January 1999

TABLE 2 (Continued)

<u>FUGITIVE DUST SOURCE CATEGORY</u>	<u>CONTROL ACTIONS</u>
<b>Unpaved Roads</b>	(4a) Water all roads used for any vehicular traffic at least once per every two hours of active operations [3 times per normal 8 hour work day]; OR (4b) Water all roads used for any vehicular traffic once daily and restrict vehicle speeds to 15 miles per hour; OR (4c) Apply a chemical stabilizer to all unpaved road surfaces in sufficient quantity and frequency to maintain a stabilized surface.
<b>Open storage piles</b>	(5a) Apply chemical stabilizers; OR (5b) Apply water to at least 80 [70] percent of the surface area of all open storage piles on a daily basis when there is evidence of wind driven fugitive dust; OR (5c) Install temporary coverings; OR (5d) Install a three-sided enclosure with walls with no more than 50 percent porosity which extend, at a minimum, to the top of the pile.
<b><u>All Categories</u></b>	(6a) Any other control measures approved by the Executive Officer and the U.S. EPA as equivalent to the methods specified in Table 2 may be used.

\* Measures in [brackets] are reasonably available control measures and only apply to sources not within the South Coast Air Basin.

January 1999

**TABLE 3**  
**TRACK-OUT CONTROL OPTIONS**  
**PARAGRAPH (d)(5)(B)**

**CONTROL OPTIONS**

(1)	Pave or apply chemical stabilization at sufficient concentration and frequency to maintain a stabilized surface starting from the point of intersection with the public paved surface, and extending for a centerline distance of at least 100 feet and a width of at least 20 feet.
(2)	Pave from the point of intersection with the public paved road surface, and extending for a centerline distance of at least 25 feet and a width of at least 20 feet, and install a track-out control device immediately adjacent to the paved surface such that exiting vehicles do not travel on any unpaved road surface after passing through the track-out control device.
(3)	Any other control measures approved by the Executive Officer and the U.S. EPA as equivalent to the methods specified in Table 3 may be used.

January 1999

**SKYVIEW ROAD  
RECONSTRUCTION PROJECT**

**PROJECT NO. C1-0534**

**SPECIAL PROVISIONS**

**DESCRIPTION:**

In general, this project consists of reconstruction of approximately 550 lf and resurfacing approximately 915 lf of Skyview Road in the City of Jurupa Valley. The work includes traffic control, removal of existing asphalt concrete pavement, grading, construct concrete curb & gutter, placement of base and asphalt concrete pavement, cold plane, crack sealing, place asphalt concrete pavement, asphalt concrete dikes, driveways reconstruction, additional improvements include striping, pavement markings, and other work as may be required.

**SPECIFICATIONS:**

This project shall conform to the requirements of the May 2006 edition of the Standard Specifications and Standard Plans as issued by the State of California Department of Transportation.

Requirements on the construction plans for Portland Cement Concrete are modified to the PCC Class designations, as described in Section 90-1.01 of the 2006 Standard Specifications, as follows:

Class "A" shall mean Class "2"  
Class "B" shall mean Class "3"  
Class "C" shall mean Class "4"  
Class "D" shall mean Class "1"

**LIQUIDATED DAMAGES:**

The Contractor shall diligently prosecute the work to completion before the expiration of **20 working days** from the date stated in the "Notice to Proceed". The Contractor shall pay to the County of Riverside the sum of **\$2,500.00** per day, for each and every calendar day delay in finishing the work in excess of the number of working days prescribed above.

**Additional Liquidated Damages:**

The project is further divided as follows:

The Contractor shall have **10 working days** to complete the pavement reconstruction work, including pavement removal, grading, base, concrete curb & gutter and first lift of pavement. The Contractor shall pay to the County of Riverside the sum of **\$2,500.00** per day, for each and every calendar day's delay in finishing the reconstruction work in excess of the number of working days prescribed above.

**DISPOSAL OF EXCESS EXCAVATION OR MATERIALS:**

Excess earth excavation, pavement grindings and other excess materials resulting from construction operations shall be disposed of by the Contractor outside of the highway right of way, as provided in Section 7-1.13 of the Standard Specifications.

The second paragraph of Section 7-1.13 of the Standard Specifications is modified to read as follows:

When any material is to be disposed of outside the highway right of way, and the County of Riverside has not made arrangements for the disposal of such material, the Contractor shall first obtain written authorization from the property owner on whose property the disposal is to be made and he shall file with the Engineer said authorization or a certified copy thereof together with a written release from the property owner absolving the County of Riverside from any and all responsibility in connection with the disposal of material on said property. If the disposal of materials is to be made at an established disposal facility that is available for public use, the Contractor shall retain all authorizations and receipts from said disposal facility and shall provide copies to the Engineer upon request.

**PROJECT APPEARANCE:**

The Contractor shall maintain a neat appearance to the work.

In any area visible to the public, the following shall apply:

When practicable, broken concrete and debris developed during clearing and grubbing shall be disposed of concurrently with its removal. If stockpiling is necessary, the material shall be removed or disposed of weekly.

Full compensation for conforming to the provisions in this section, not otherwise provided for, shall be considered as included in the prices paid for the various contract items of work involved and no additional compensation will be allowed therefor.

**RECORD DRAWINGS:**

The Contractor shall keep one clean set of bond originals to note any changes which take place during construction. These changes to the original plans and/or specifications shall be noted at the appropriate locations with the appropriate changes indicated in red pencil or ink. The Contractor shall note in large letters "RECORD DRAWINGS" on the Title Sheet of the plans. The job will not be finalized by the Engineer until these record drawings have been

completed to the satisfaction of the Engineer. The changes shall be noted on the plans as the changes occur. The record drawings shall be submitted to the Resident Engineer, and become the property of the County at conclusion of the project.

Full compensation for maintaining and compiling the record drawings shall be considered to be included in other items of work and no additional compensation will be allowed therefor.

**SURVEY STAKING:**

County surveyors will establish external primary survey control marks and/or monuments to be used throughout the construction period. These control marks will be used by the County Surveyor to set construction stakes. The control marks will also be used to make verification surveys at various stages of work.

The County places stakes and marks per the County's Survey Manual.

Contractor must submit request for County furnished stakes:

1. Once staking area is ready for stakes
2. Request for construction stakes must be in writing.

The County will provide Contractor with a survey request form. A minimum notice of 2 working days is required from the Contractor prior to County Surveyor beginning the work requested.

Contractor must preserve stakes and marks placed by the County. Survey costs are incurred by the County; however, if the stakes or marks are destroyed, the County replaces them at the County's earliest convenience and deducts the replacement expenses.

**OBTAIN ENCROACHMENT PERMIT:**

It shall be the responsibility of the Contractor to obtain an encroachment permit for work within the Right-Of-Way of the City of Jurupa Valley.

Encroachment permit shall be at no cost to the contractor.

If the Contractor pays any fees to the City of Jurupa Valley to obtain Encroachment Permit, then the full compensation for the actual cost of the Encroachment Permit fees, as paid by the Contractor to City of Jurupa Valley shall be made on a force account basis, in accordance with Section 9-1.03 of the Standard Specifications and these Special Provisions, up to the fixed bid price. No markups will be allowed. All incidental costs incurred by the Contractor shall be considered as included in the various items of work and no compensation will be allowed therefor.



**ADDITIONAL INSURANCE-HOLD HARMLESS:**

In addition to the requirements of Section 18, "Insurance – Hold Harmless" in General Condition section of the contract documents, the Contractor's Certificate of Insurance and endorsements for the project shall name **the City of Jurupa Valley, its officers, directors, employees and agents** as additional insured under the Contractor's general liability, excess liability and auto liability insurance policies and on the Waiver of Subrogation for the Contractor's Workers Compensation policy.

Full compensation for compliance with the requirements of this Section shall be considered as included in the various items of work and no additional compensation will be allowed therefore.

## ITEMS OF WORK

### PARTIAL PAYMENTS:

Attention is directed to Sections 9 1.06, "Partial Payments," and 9 1.07, "Payment After Acceptance," of the Standard Specifications and these special provisions.

For the purpose of making partial payments pursuant to Section 9- 1.06, "Partial Payments," of the Standard Specifications, the amount set forth for the contract items of work hereinafter listed shall be deemed to be the maximum value of the contract item of work which will be recognized for progress payment purposes:

A.	Clearing and Grubbing	\$ 22,000
B.	Dust abatement	\$ 3,000

After acceptance of the contract pursuant to the provisions in Section 7-1.17, "Acceptance of Contract" of the Standard Specifications, the amount, if any, payable for a contract item of work in excess of the maximum value for progress payment purposes hereinabove listed for the item, will be included for payment in the first estimate made after acceptance of the contract.

### ORDER OF WORK:

Order of work shall conform to the provisions in section 5-1.05, "Order of Work" of the Standard Specifications and these Special Provisions.

Attention is directed to "Public Convenience" of these Special Provisions regarding access to the homes and business with driveways on Skyview Avenue. The Contractor shall coordinate with these occupants to make accommodations to provide continual access available.

Attention is directed to "Clearing and Grubbing" of these Special Provisions regarding private improvements within the public right of way. There are several homes on Skyview Road with private improvements within the public right of way. The Contractor shall work directly with the property owners to minimize the disturbance to the private improvements including driveways and decorative features. The contractor must provide to the Engineer proof that coordination and arrangements are made with the various property owners before the clearing and grubbing of private improvements.

Attention is directed to "Obstruction" of these Special Provisions regarding the presence of existing main, lateral and service utility facilities and potholing within the cut areas. The contractor is responsible to ascertain the exact locations of existing underground facilities, shown or not shown in the plans. No additional compensation is allowed for determining such locations of existing facilities.

There is an existing 12" High Pressure Gas Main located under the northerly edge of pavement. The depth is estimated to be approximately 30" below existing grade. **Don't hit it!**

**COOPERATION:**

Attention is directed to Section 7-1.14, "Cooperation" of the Standard Specifications and these Special Provisions.

The Contractor is hereby advised to cooperate with utility companies (Gas Company, JCSD and/or others) for adjusting manhole to grade.

Should construction be under way by other forces or by other Contractors within or adjacent to those limits, the Contractor shall cooperate with all the other Contractors or other forces to the end that any delay or hindrance to their work will be avoided. The right is reserved to perform other or additional work at or near the site (including material sources) at any time, by the use of other forces.

**OBSTRUCTIONS:**

Attention is directed to Sections 8-1.10, "Utility and Non-Highway Facilities", and 15, "Existing Highway Facilities" of the Standard Specifications and these Special Provisions.

Existing utility and privately owned facilities shall be protected in accordance with Section 7-1.11, "Preservation of Property" and these Special Provisions. The Contractor is also responsible to protect those facilities that are to be relocated by others prior to or during construction, and shall protect those facilities in both their existing and their ultimate locations. The Contractor shall cooperate with owners and their Contractors of utility and privately owned facilities, for the relocation of said facilities, in accordance with Section 7-1.14, "Cooperation" of the Standard Specifications.

All water valves and covers, gas valves and covers, sewer manholes, survey monuments, survey markers and any other utility appurtenances shall be protected in place.

The Contractor's attention is directed to the existence of certain underground facilities that may require special precautions be taken by the Contractor to protect the health, safety and welfare of workmen and the public. Facilities requiring special precautions include, but are not limited to: conductors of petroleum products, oxygen, chlorine, and toxic or flammable gases; natural gas in pipe lines greater than 6 inches in diameter or pipe lines operating at pressures greater than 60 psi (gage); underground electric supply system conductors or cables either directly buried or in duct or conduit which do not have concentric neutral conductors or other effectively grounded metal shields or sheaths; and underground electrical conductors with potential to ground of more than 300 volts. The Contractor shall notify the Engineer at least twenty-four hours prior to performing any work in the vicinity of such facilities.

Attention is directed to the requirements of Government Code Sections 4216-4216.9 pertaining to existing utility facilities.

The Contractor shall assume that every house, building and lot within the project limits has utility service pipes and conductors (laterals), and that utility main and trunk facilities exist within the project limits. The Contractor shall determine if it is warranted to determine the exact location of these utility service laterals and existing main lines, unless directed by the

Engineer to pot-hole at specific locations, or as otherwise required herein. The Contractor will not be directly reimbursed for determining the exact location of the utility main lines or services laterals but shall include any compensation for this work in the contract price paid for the various items of work. Any damage to existing main lines or service laterals for which pot-holing was not performed shall be considered damage due to not using reasonable care and the damage shall be repaired at the Contractor's expense.

The Contractor shall conduct his operations with the assumption that underground utility facilities exist within the project limits. The Contractor shall exercise caution and best construction practices for safety and for protection of underground facilities. The approximate locations of underground utility facilities, as shown on the plans, are based on information provided by the respective owners, listed below. The Contractor shall also utilize the markings of the regional notification center (Underground Service Alert), and above-ground utility appurtenances to determine the existence and approximate location of underground utilities.

The Contractor's attention is directed to the presence of main, lateral and service utility facilities that exist within the cut areas, generally between construction stations 14+00 and 19+00. The depths of the utility facilities are unknown but are anticipated to be sufficiently below the grading plane to allow protection of the facilities. Prior to performing any excavation within those limits, the Contractor shall determine the exact elevation of each and every service and lateral utility, and each and every main / trunk line at spacing and locations adequate to assure protection of the utility facility. Contractor shall be responsible to protect each utility facility. In the event that any utility facility is found to be above the grading plane, or shallow enough that the facility cannot be protected, the Contractor shall inform the Engineer, who shall arrange for review by the Utility owner for determination of a proper course of action. Attention is directed, especially, to the presence of a high pressure gas pipeline, which shall be potholed at no less than 100 foot intervals prior to excavation.

No excavation shall be made **within 4 feet of any other underground utilities**, as shown on the plans and/or marked by Underground Service Alert, unless and until such utilities have been positively located as to horizontal and vertical position. This requirement applies to all underground electric, natural gas, toxic or flammable gas, chlorine, oxygen or petroleum facilities.

Forty-eight hours prior to beginning construction, the Contractor shall notify the following agencies:

Underground Service Alert	800-227-2600
Southern California Edison Company	909-357-6221
Southern California Gas Company	909-335-7561
Sprint Communication	909-873-8022
Verizon Communications	951-925-6253
Adelphia Communications	951-975-3402
Charter Communication	951-343-5100
Jurupa Community Service District	951-685-7434
MCI network Services	972-729-6016
Santa Ana Watershed	951-354-4220
AT & T California	714-666-5401
Time Warner Telecom	925-953-7093

### Adjustments to Grade for Obstructions

The Contractor shall adjust to finish grade any valve covers encountered within the project limits, as required, for those utility valves that are provided with slip cans and are adjustable without the replacement of parts or the removal of concrete collars. In cases where the owning utility company insists upon upgrades in the standards, or when additional parts or the removal of concrete collars are required for the adjustment, said adjustment will be the responsibility of the owning utility company.

Communication and coordination with the owning utility company shall be the responsibility of the contractor.

For public safety, traffic shall not be allowed on temporary or permanent pavement until all manholes are either adjusted to grade or otherwise protected, as approved by the Engineer. The Contractor shall adjust to grade manholes and valves when and as necessary for the protection of the traveling public during construction, and shall coordinate all work on said facilities with the owning utility companies. This requirement is intended for traffic that is to be allowed on temporary surfaces during the course of construction. Final adjustment to grade will be the responsibility of the owning utility company, except as provided herein.

Said work shall be performed in accordance with Section 15-2.05A, "Frames, Covers, Grates, and Manholes" of the Standard Specifications. Full compensation for adjustment of valve covers shall be considered as included in the contract price paid for asphalt concrete, or applicable items of work in the event that there is no asphalt concrete bid item, and no additional compensation will be allowed therefor.

All existing utility facilities shall be protected from damage by the Contractor's operations.

Unless otherwise provided herein, the owning utility companies will not be obligated to lower their surface utilities (manholes and valve covers) for Contractor's grading, grinding and/or paving operations. The contractor shall lower surface facilities, including manholes and valve covers, to facilitate construction, and the following shall apply:

1. Contractor shall coordinate all work with the utility owner.
2. Contractor shall be responsible for all costs and shall be responsible for any damage caused to the owner's facilities. If the Contractor observes any pre-existing damage to the utility facilities, the Contractor shall notify the Engineer and the utility owner of that damage prior to performing additional work on the facility.
3. Contractor shall, after removing grade rings and covers, arrange for pickup by, or delivery to, the owner's yard. Any and all concrete collars removed by the Contractor shall become the property of the Contractor, and shall be disposed of as specified elsewhere in these special provisions.
4. The Contractor is advised that he is responsible for ensuring that construction materials do not enter the utility owner's facilities. The Contractor shall install traffic bearing steel plates for this purpose, and provide all coordination and transportation necessary. It is recommended that the Contractor request the utility owner to provide

such steel plates. If the Contractor provides steel plates, it shall be the Contractor's responsibility to coordinate with the utility owner for the return of the steel plates to the Contractor after final adjustment to grade. If the Contractor utilizes utility owner's steel plates, and if the Contract items of work include adjustment to final grade, the Contractor shall return the steel plates to the Utility owner's yard, or as otherwise arranged with the Utility owner.

5. Prior to paving or covering the plated utility facility, the Contractor shall tie-out the facility utilizing a method acceptable to the utility owner and provide notes and data of all covered facilities to both the utility owner and the Engineer.
6. The Contractor shall notify the utility owner, upon completion of the Contractor's work, when the utility owner may move in to make the final adjustments to grade.
7. The requirements for lowering of surface facilities shall not apply to vaults. The Contractor shall notify the utility owner of the need to make adjustments to such major facilities.
8. The Contractor is reminded that the utility facilities are owned by public and private utility companies that operate their facilities within public rights of way. The utility owner's preferences with regards to the handling of its facilities shall be complied with to the greatest extent feasible.

## **PAYMENT**

Full compensation for all costs, including labor, equipment, materials and incidentals, required to comply with the requirements of this section above, including protection of water valves and covers, gas valves and covers, sewer manholes, survey monuments, survey markers and any other utility appurtenances, shall be considered as included in the various items of work, and no additional compensation will be allowed therefor.

Full compensation for initial lowering of surface utilities facilities shall be considered as included in the contract price paid for asphalt concrete, or applicable items of work in the event that there is no asphalt concrete bid item, and no additional compensation will be allowed therefor.

## **WATER POLLUTION CONTROL (SANTA ANA RIVER BASIN):**

Throughout the term of this contract, the total land disturbance area of the project site shall be less than 1 acre. The Contractor shall comply with the Area-Wide Municipal Stormwater Permit NPDES No. CAS 618033, hereafter referred to in this section as the "Municipal Permit", issued by the California Regional Water Quality Control Board (CRWQCB) – Santa Ana Region. This Permit regulates both stormwater and non-stormwater discharges associated with Contractor's construction activities. A copy of the Permit may be obtained at the office of the County of Riverside Transportation Department, 14<sup>th</sup> Street Transportation Annex, 3525 14<sup>th</sup> Street, Riverside, California. (951) 955-6780, or may be obtained on the internet at: <http://www.waterboards.ca.gov/santaana/>

The Contractor shall comply with the requirements of the Municipal Permit, and all other applicable federal, state and local laws, ordinances, statues, rules, and regulations concerning water pollution control.

Contractor's Water Pollution Control Program (WPCP) Preparation Manual shall be prepared by a Qualified SWPPP Developer in accordance with Section 3, "Preparing a Water Pollution Control Program (WPCP)", of the *Caltrans Stormwater Pollution Prevention Plan (SWPPP) and Water Pollution Control Program (WPCP) Preparation Manual (March 2007)*, which is available as a free download from:

<http://www.dot.ca.gov/hq/construc/stormwater/manuals.htm>

## WATER POLLUTION CONTROL MEASURES

- A. Work having the potential to cause water pollution shall not commence until the Contractor's WPCP has been reviewed and approved by the Engineer. The Engineer's review and approval of the Contractor's WPCP shall not waive any contractual requirements and shall not relieve the Contractor from achieving and maintaining compliance with all federal, state, and local laws, ordinances, statues, rules, and regulations. A copy of Contractor's WPCP shall be maintained onsite. When the WPCP or access to the construction site is requested by a representative of a federal, state, or local regulatory agency, Contractor shall make the WPCP available and Contractor shall immediately contact the Engineer. Requests from the public for the Contractor's WPCP shall be directed to the Engineer.
- B. Contractor's WPCP shall describe the Contractor's plan for managing runoff during each construction phase. Contractor's WPCP shall describe the Best Management Practices (BMPs) that will be implemented to control erosion, sediment, tracking, construction materials, construction wastes, and non-stormwater flows. BMP details shall be based upon California Stormwater Quality Association's 2009 California Stormwater Quality BMP Handbook Portal (<http://www.cabmphandbooks.com>) or the Caltrans Construction Site BMP Manual (<http://www.dot.ca.gov/hq/construc/stormwater/manuals.htm>). Contractor's WPCP shall describe installation, operation, inspection, maintenance, and monitoring activities that will be implemented for compliance with the Municipal Permit and all applicable federal, state, and local laws, ordinances, statutes, rules, and regulations related to the protection of water quality.
- C. The Contractor's WPCP preparer shall have been trained to prepare WPCPs or SWPPPs and shall have previous experience with preparing SWPPP or WPCP requirements on a previous project.

The Contractor shall designate a Water Pollution Control Manager that shall have been trained to implement WPCP or SWPPP requirements. Contractor's Water Pollution Control Manager shall:

1. Be responsible for all water pollution control work.
2. Be the Engineer's primary contact for all water pollution control work.

3. Have the authority to mobilize resources (crews, supplies, equipment, etc.) to make immediate repairs of water pollution control measures or to supplement water pollution control measures to maintain compliance with all federal, state, and local laws, ordinances, and regulations related to the protection of water quality, including the Municipal Permit.

The WPCP shall contain all required and applicable certifications and evidence of training for the Water Pollution Control Manager, WPCP Developer, and all other employees working on the project receiving formal training or certification.

D. Water Pollution Control Training: Contractor shall provide water pollution control training to Contractor's employees and subcontractors prior to their performing work on the work site. The water pollution control training shall be appropriate to the employee or subcontractor function and area of responsibility and shall address (as applicable):

1. Erosion Control (water and wind)
2. Sediment Control
3. Tracking Control
4. Materials & Waste Management
5. Non-Stormwater Discharge Management

E. Monitoring and Reporting: Observations and inspections conducted by the Contractor's Water Pollution Control Manager shall be documented on the Construction Site Inspection Checklist included in Contractor's WPCP. A copy of each completed Construction Site Inspection Checklist shall be submitted to the Engineer within 24 hours of conducting the inspection.

#### **General Requirements:**

In the event the County incurs any Administrative Civil Liability (fine) imposed by the CRWQCB – Santa Ana Region, as a result of Contractor's failure to fully implement the provisions of "Stormwater and Non-Stormwater Pollution Control", the Engineer, may, in the exercise of his sole judgment and discretion, withhold from payments otherwise due Contractor a sufficient amount to cover the Administrative Civil Liability including County staff time, legal counsel, consultant support costs and all other associated cost.

The Contractor shall be responsible for all costs and for any liability imposed by law as a result of the Contractor's failure to comply with the requirements set forth in "Water Pollution Control", including but not limited to, compliance with the applicable provisions of the Caltrans Handbooks, Municipal Permit, Federal, State, and local regulations. For the purpose of this paragraph, costs and liabilities include, but not limited to, fines, penalties, damages, and costs associated with defending against enforcement actions whether taken against the County or the Contractor, including those levied under the Federal Clean Water Act and the State Porter-Cologne Water Quality Act.

Within fifteen (15) working days after the award of the contract, the Contractor shall submit two (2) copies of the WPCP to the Engineer for review and approval. The Contractor shall allow ten (10) working days for the Engineer to review the WPCP. If revisions are required as determined by the Engineer, the Contractor shall revise and resubmit the WPCP within three (3) working days of receipt of the Engineer's comments and shall allow ten (10) working days



for the Engineer to review the revisions. The Contractor shall submit four (4) copies of the approved WPCP to the Engineer prior to notice to proceed. The Contractor must have an approved WPCP prior to the notice to proceed. The Engineer may provide a letter of conditional approval of the Contractor's WPCP while minor revisions are made and may allow the Contractor to begin only those certain construction activities identified in the letter of conditional approval. In no case will the conditional approval extend beyond twenty-one (21) calendar days. The Engineer may suspend construction operations until the Contractor submits a revised WPCP that is reviewed and approved by the Engineer.

Unless otherwise directed by the Engineer or specified in these Special Provisions, the Contractor's responsibility for WPCP implementation shall continue throughout any temporary suspension of work ordered in accordance with Section 8-1.05, "Temporary Suspension of the Work", of the Standard Specifications. The Engineer may withhold progress payments or order the suspension of construction operations without an extension of the contract time, if the Contractor fails to comply with the requirements of "Water Pollution Control" as determined by the Engineer.

All BMP repairs shall be implemented by the Contractor within 72 hrs. All BMP repairs shall also be implemented by the Contractor prior to a qualifying storm event, as defined in the Construction General Permit. The Contractor shall be responsible for bi-weekly, pre and post storm, and quarterly (Jan-Mar, Apr-Jun, Jul-Sept, and Oct-Dec) non-stormwater inspections. At the direction, the Contractor shall be responsible for providing any information for annual reporting purposes in electronic format, including inspection reports, photos,, etc.

Payment for Water Pollution Control shall be on a lump sum basis and shall include full compensation for the work performed, including, developing, preparing, revising, obtaining approval of, and amending the WPCP, implementing, installing, constructing, operating, maintaining, and removing and disposing of temporary BMPs, performing the observations, inspections, sampling, analysis, reporting, and street sweeping, and as specified in the Caltrans Handbooks, Municipal Permit and these Special Provisions, and as directed by the Engineer.

## **STREET SWEEPING:**

### **GENERAL**

#### **Summary**

This work includes street sweeping.

The WPCP shall describe and include the use of street sweeping as a Water Pollution Control practice for sediment control and tracking control. Street sweeping shall also conform to all applicable AQMD requirements.

#### **Submittals**

At least 5 working days before starting clearing and grubbing, or other activities with the potential for tracking sediment or debris, submit:

- A. The number of street sweepers that will be used as described in the WPCP.
- B. Type of sweeper technology (or technologies).

### **Quality Control and Assurance**

Retain the following records related to street sweeping and submit weekly to Engineer:

- A. Tracking Inspection Log
- B. Sweeping times and locations.
- C. Quantity of sweeping waste disposal.

## **CONSTRUCTION**

### **Street Sweepers**

Sweepers must use one of these technologies:

- A. Mechanical sweeper followed by a vacuum-assisted sweeper.
  - B. Vacuum-assisted dry (waterless) sweeper.
  - C. Regenerative-air sweeper.
- or
- D. Sweeping by hand is acceptable in lieu of A, B, and C above.

### **Operation**

Street sweeping shall be conducted at:

- A. Paved roads at job site entrance and exit locations.
- B. Paved areas within the job site that flow to storm drains or water bodies.

Street sweeping shall be conducted, and sweeper(s) shall be available to operate at all times, for the following:

- A. During clearing and grubbing activities.
- B. During earthwork activities.
- C. During trenching activities.
- D. During roadway structural section activities.
- E. When vehicles are entering and leaving the job site.
- F. After soil disturbing activities.
- G. After observing offsite tracking of material.

Contractor's Water Pollution Control Manager shall inspect adjacent paved areas at job site entrances and exits and paved roadways within the job site on a minimum daily basis, and more frequently when activities that require street sweeping are being performed. Contractor's Water Pollution Control Manager shall maintain a "Tracking Inspection Log." Street sweeping shall be conducted:

- A. Within 1 hour, if sediment or debris is observed on paved areas or paved roadways.

At least one sweeper, in good working order, must be available within 4 hours to be on the job site when sweeping work may be required.

Perform street sweeping to minimize dust. If dust generation is excessive or sediment pickup is ineffective, water may be used but shall be contained, collected (e.g. vacuum), and properly disposed.

Material collected during street sweeping must be removed and disposed of under Section 7-1.13, "Disposal of Material Outside the Highway Right of Way" of the Standard Specifications.

Full compensation to conform with the requirements of this section shall be considered as included in the contract lump sum price paid for Water Pollution Control including furnishing all labor, materials, tools, equipment, and incidentals and for doing all the work involved in street sweeping, including disposal of collected material, as shown on the plans, as specified in the Standard Specifications, these Special Provisions, and as directed by the Engineer. Therefore, no additional compensation will be allowed for street sweeping.

**TRAFFIC CONTROL SYSTEM/ PUBLIC CONVENIENCE/ PUBLIC SAFETY:**

Contractor shall prepare construction staging, and traffic control plans for review and approval by the Transportation Department and City of Jurupa Valley.

Proposed plans shall be submitted by the Contractor for review and approval by the Transportation Department at least two weeks prior to the start of construction. The construction staging, and traffic control plans shall be prepared, signed and stamped by a Civil Engineer or Traffic Engineer who is registered as such in the State of California, unless otherwise specifically allowed by the Engineer. The Contractor shall revise and implement the plans as directed by the Engineer. Construction shall not begin until the Engineer provides Contractor with County approval of the plans.

Construction staging, and traffic control plans shall be in accordance with the appropriate standards and specifications for construction staging, detour roads, traffic control, including the State of California Highway Design Manual, the manual on Uniform Traffic Control Devices 2006 Edition, the corresponding California Supplement, and subsequent modifications as adopted by the State of California Department of Transportation, Standard Plans and Standard Specifications, and the Work Area Traffic Control Handbook (WATCH), as published by Building News, Inc. Any requests for deviation from the established design standards or specifications are to be submitted to the Engineer for review and approval prior to submission of the required plans.

With regard to the preparation and implementation of the plans, attention is especially directed to Sections 7-1.06, 7-1.08, 7-1.09, 7-1.11, 7-1.12 and Section 12 of the State of California Standard Specifications. Section 12-2.02 of the Standard Specifications is deleted.

Maintaining traffic shall conform to the provisions in 7-1.02 "Load Limitations", 7-1.06 "Safety and Health Provisions", 7-1.08 "Public Convenience", 7-1.09 "Public Safety", and 12-3.04 "Portable Delineators" of the Standard Specifications, the Manual on Uniform Traffic Control Devices 2006 Edition, the corresponding California Supplement, and subsequent modifications as adopted by the State of California Department of Transportation, the Section

of these contract documents entitled "Insurance - Hold Harmless", and these Special Provisions.

All existing traffic control signs and street name signs shall be maintained in visible locations as directed by the Engineer.

Portable changeable message signs shall be furnished, placed, operated and maintained at those locations shown on the approved Traffic Control Plans or where designated by the Engineer in conformance with the provisions in Section 12, "Construction Area Traffic Control Devices" of the Standard Specifications and these Special Provisions.

All warning lights, signs, flares, barricades and other facilities for the sole convenience and direction of public traffic shall be furnished and maintained by the Contractor. All traffic control devices shall conform to and be placed in accordance with the Manual on Uniform Traffic Control Devices 2006 Edition, the corresponding California Supplement, and subsequent modifications as adopted by the State of California Department of Transportation.

All construction signs shall be either covered or removed when not required by the nature of the work or if no present hazard to the motorist exists.

The Contractor shall notify the appropriate regional notification center for operators of subsurface installations at least 2 working days, but not more than 14 calendar days, prior to commencing excavation for construction area sign posts. The regional notification centers include, but not limited to, the following:

Notification Center	Telephone Number
Underground Service Alert-Southern California (USA)	1-800-422-4133 1-800-227-2600 or 811

Excavations required to install construction area signs shall be performed by hand methods without the use of power equipment, except that power equipment may be used if it is determined there are no utility facilities in the area of the proposed post holes.

No payment for extra work will be allowed for work performed as specified in Section 12-2.02 (Flagging Costs) of the Standard Specifications. Flagging costs will be borne entirely by the Contractor.

Dust control shall conform to the provision of Section 10 of the Standard Specifications except that no extra work will be allowed when the Engineer orders the application of water for the purpose of controlling dust caused by public traffic as provided for in the last paragraph of Section 10.

The Contractor shall be responsible to distribute an information letter pertaining to the planned work to all affected residences and businesses, at least one week prior to commencing work adjacent to those residences and businesses. It shall be the responsibility of the Contractor to prepare, print sufficient copies, and distribute the letter. The primary logo shall be the City of Jurupa Valley with the Riverside County Transportation Department logo also

included on the letter. A computer file of the logo may be obtained from the Engineer in .WPG, .DXF, .DGN or .DWG format. The letter shall be similar to the sample provided by the Engineer, and shall include a project description, the scope of work, the anticipated construction schedule, and other information as appropriate.

The Contractor shall post temporary no parking signs on affected streets 24 hours prior to work on those streets. The temporary no parking signs shall state the anticipated dates and hours of work on those streets.

## **PAYMENT**

Full compensation, except as otherwise provided herein, for conforming to the requirements of this article, including furnishing, installing and maintaining all traffic control devices shown on the construction staging, and traffic control plans, shall be paid for on a lump sum basis, and no additional compensation will be allowed therefor.

## **MAINTAINING TRAFFIC:**

Maintaining traffic shall conform to the provisions in Section 7-1.08, "Public Convenience", Section 7-1.09, "Public Safety" and Section 12, "Construction Area Traffic Control Devices" of the Standard Specifications and "Public Safety" of these Special Provisions.

Daily working hours shall be between the hours of 7:00 a.m. and 6:00 p.m., Monday through Friday, except legal holidays, as approved by the Engineer. Exceptions and specific work schedules shall be submitted to the Engineer for consideration.

Closure is defined as the closure of a traffic lane or lanes, including shoulder, ramp or connector lanes, within a single traffic control system. Lane closure is allowed only during contractor's work hours. Closure to through traffic is allowed on Skyview Drive from Westerly John Drive to Peralta Place for 10 working days. All traveled lanes must be opened to traffic during non working hours excluding reconstruction area.

Attention is directed to Liquidated Damages of these Special Provisions for delays.

Closure shall conform to the provisions in "Traffic Control System" of these Special Provisions.

Local authorities shall be notified at least five (5) business days before work begins. The Contractor shall cooperate with local authorities to handle traffic through the work area and shall make arrangements to keep the work area clear of parked vehicles.

Personal vehicles of the Contractor's employees shall not be parked on the traveled way or shoulders including sections closed to public traffic.

When work vehicles or equipment are parked on the shoulder within six (6) feet of a traffic lane, the shoulder area shall be closed.

When work vehicles or equipment are parked on the shoulder within six (6) feet of a traffic lane, the shoulder area shall be closed with fluorescent orange traffic cones or portable delineators placed on a taper in advance of the parked vehicles or equipment and along the edge of the pavement at 25-foot intervals to a point not less than 25 feet past the last vehicle or piece of equipment. A minimum of 9 traffic cones or portable delineators shall be used for the taper. A W20-1 (ROAD WORK AHEAD) or W21-5b (RIGHT/LEFT SHOULDER CLOSED AHEAD) or C24 (CA) (SHOULDER WORK AHEAD) sign shall be mounted on a crashworthy portable sign support with flags. The sign shall be placed where designated by the Engineer. The sign shall be a minimum of 48" x 48" in size. The Contractor shall immediately restore to the original position and location a traffic cone or delineator that is displaced or overturned, during the progress of work.

If minor deviations are required on traffic control plan, a written request shall be submitted to the Engineer at least 15 days before the proposed date of the closure. The Engineer may approve the deviations if there is no significant increase in the cost to the County and if the work can be expedited and better serve the public traffic.

Designated legal holidays are January 1<sup>st</sup>, the third Monday in February, the last Monday in May, July 4<sup>th</sup>, the first Monday in September, October 10, November 11<sup>th</sup>, Thanksgiving Day, and December 25<sup>th</sup>. When a designated legal holiday falls on a Sunday, the following Monday shall be a designated legal holiday. When November 11<sup>th</sup> falls on a Saturday, the preceding Friday shall be a designated legal holiday.

#### **PAYMENT**

Full compensation for furnishing, erecting, maintaining, removing and disposing of the C43 (CA), W20-1, W21-5b and C24 (CA) signs shall be considered as included in the contract lump sum price paid for Traffic Control System and no additional compensation will be allowed therefor.

#### **DEVELOP WATER SUPPLY:**

Develop water supply shall conform to the provisions of Section 17 of the Standard Specifications and these Special Provisions.

Attention is directed to the requirements of Section 10, "Dust Control". Water in amounts specified by the Engineer will be used for dust control, and the cost thereof will be included in the lump sum price paid for Dust Abatement.

#### **PAYMENT**

Full compensation for developing water supply and furnishing watering equipment shall be paid for on a lump sum basis and no additional compensation will be allowed therefore.

### **CLEARING AND GRUBBING:**

Clearing and grubbing shall conform to the provisions in Section 16 of the Standard Specifications.

Removal and disposal of existing river rock sidewalk shall be considered as included in the Clearing and Grubbing for payment purposes.

Reconstruction of block wall as shown on the plans shall be considered as included in the Clearing and Grubbing for payment purposes. Prior to the full payment of this item for Clearing and Grubbing, the contractor must obtain a written consent from the property owner that the reconstruction of the block wall is to the satisfaction of the property owner.

Shrubs and bushes shall be removed as directed by the Engineer and disposed of completely.

Removed vegetation and hardscape shall be the property of the Contractor and shall be disposed of by the Contractor, as provided in Section 7-1.13 of the Standard Specifications.

All dirt driveways shall be reconstructed per the plans and as directed by resident engineer.

Contractor shall adjust existing gates (swing and sliding) in conformance with the locations shown on the plans and as directed by the engineer shown on the plan

### **PAYMENT**

Clearing and Grubbing shall be paid on a Lump sum basis.

Full compensation, except as otherwise provided herein, for conforming to the requirements of this article including Rout and Seal random cracks, reconstruct dirt driveways, adjustment of gates, removal and disposal of block wall and decorative sidewalk, shall be paid for on a lump sum basis and no additional compensation will be allowed therefor.

### **COLD PLANE ASPHALT CONCRETE PAVEMENT:**

The Contractor shall cold plane the asphalt concrete pavement to a depth as shown on the approved plans or as directed by the Engineer.

The Contractor shall wedge plane 6 feet adjacent to the concrete curb and gutter to a depth as shown on the plans or as directed by the Engineer.

The cold plane machine shall have a cutter head at least 72 inches wide and shall be operated so as not to produce fumes or smoke.

The depth, width and shape of the cut shall be as indicated on the plans. The outside lines of the planed area shall be neat and uniform. The road surfacing to remain in place shall not be damaged in any way.

The material planed from the roadway surface, including material deposited in existing gutters or on the adjacent traveled way shall become the property of the Contractor and shall be immediately removed from the site of the work and disposed of as provided in Section 7-1.13, "Disposal of Material Outside the Highway Right of Way", of the Standard Specifications. The removal crew shall follow within 50 feet of the planer, unless otherwise directed by the Engineer.

Nothing in these Special Provisions shall relieve the Contractor from his responsibilities as provided in Section 7-1.09, "Public Safety" of the Standard Specifications.

## **PAYMENT**

The contract unit bid price paid per square yard for Cold Plane Asphalt Concrete Pavement shall include full compensation for providing all labor, tools, equipment and disposing of the grindings, and no additional compensation will be allowed therefor.

## **ROUT AND SEAL RANDOM CRACKS:**

All cracks will be filled with a rubberized asphalt material that has a minimum softening point temperature of 200 degrees Fahrenheit and a safe heating temperature of 380 degrees Fahrenheit, or as otherwise directed by the Engineer.

For cracks in size of 1/4 inch to 1/2 inch in width, the crack shall be widened using a router to form a sealant reservoir which is a minimum of 1/2 inch wide and 3/4 inch to 1 inch deep. The routed crack shall then be cleaned with compressed air to remove all dust and free moisture, and then sealed to service level. If a 3/8 inch asphalt concrete mix overlay is to be used, the filler material shall be deleted.

Cracks wider than 1/2 inch width shall be cleaned for the entire crack depth using sandblasting, brushing and air blowing techniques, as required to provide a crack free from all debris, dust, loose material and moisture. Gauging or plowing may be required to remove incompressible deep in the crack. The clean crack shall be filled with sealant, from the bottom up to surface level, in a manner which does not result in sealant bridging or entrapped air pockets. With deep cracks, settlement of sealant may occur, thus requiring application of a second layer of sealant material. For cracks with depressed surfaces on each side of the crack shall be over filled beyond level with pavement surface and then squeezed to fill in depressed area.

Cracks wider than 1 inch width shall be filled with pea-gravel and SS grade asphaltic emulsion as directed by the Engineer.

## **APPLICATION OF HERBICIDE AND WEED REMOVAL**

Herbicide shall be applied to all visible weeds and vegetation, and to all cracks exceeding 1/4 inch in width, within the pavement areas at least 10 days prior to removal of weeds and vegetation, or longer if the manufacturer's recommendation is for a period of time in excess of 10 days. All weeds and vegetation shall be removed from the pavement areas.



The herbicide used shall meet all Federal, State and County health and safety requirements for the intended use of the product, as described herein. Contractor shall obtain specific approval from the Engineer for the use of the herbicide proposed by the Contractor.

Contractor shall provide all necessary protection to prevent injury to adjacent plant life or property from herbicide. The Contractor will be held responsible for any personal injury or property damage caused by the transportation, storage or application of herbicides.

The Contractor shall notify the Engineer two days in advance prior to any application of herbicide.

Herbicide shall be applied by a Contractor that is properly licensed to do this work.

### **PAYMENT**

Payment for Rout And Seal Random Cracks shall be considered as included in the Lump Sum bid priced paid for Clearing and Grubbing which shall include full compensation for furnishing all labor, materials, tools, equipment and incidentals required for cracks routing, cracks cleaning, sweeping and application of herbicide and sealant, as directed by the Engineer and no additional compensation will be allowed therefor.

### **ROADWAY EXCAVATION:**

Roadway excavation shall conform to the provisions of Section 19 of the Standard Specifications and these Special Provisions.

At road connections and at limits of asphalt paving, existing pavement shall be header cut as shown on the plans or as directed by the Engineer. Full compensation for furnishing all labor, tools and doing all the work necessary including grinding, and sawcutting shall be considered as included in the contract prices paid per ton for the various asphalt concrete items and no additional compensation will be allowed therefor.

Existing pavement including any base material shall be cut back to neat lines and removed as shown on the plans or as directed by the Engineer. Excess material will become the property of the Contractor and will be disposed of as provided in Section 7-1.13 of the Standard Specifications.

Removal and disposal of existing asphalt concrete dike, concrete Curb and Gutter, and concrete or AC driveways, shall be considered as included in Roadway Excavation for payment purposes. No additional compensation will be allowed.

Removal of existing striping shall be considered as included in Roadway Excavation for payment purposes. No additional compensation will be allowed.

### **PAYMENT**

The contract unit bid price paid per cubic yard for Roadway Excavation shall include full compensation for furnishing all labor, materials, tools, equipment, and incidentals, and for

doing all work involved in Roadway Excavation/Earthwork, including sawcutting, hauling, placement and compaction of the excavated material, removal and disposal of AC dike, concrete curb and gutter, driveways and as directed by the Engineer and no additional compensation will be allowed therefor.

**Relative Compaction:**

Whenever relative compaction is specified to be determined by Test Method No. Calif. 216, the in-place density may be determined by Test Method No. Calif. 231. The in-place density required by Test Method No. Calif. 312 may be determined by Test Method No. 231. The wet weight or dry weight basis and English Units of Measurement may be used at the option of the Materials Engineer.

**AGGREGATE BASE:**

Aggregate base shall be Class 2 and shall conform to the provisions in Section 26, "Aggregate Bases" of the Standard Specifications and these Special Provisions and shall meet the gradation requirements for ¾ inch maximum.

The first paragraph of Section 26-1.02A, "Class 2 Aggregate Base" shall be modified to read:

Aggregate for Class 2 aggregate base shall be free from organic matter and other deleterious matter, and shall be of such nature that it can be compacted readily under watering and rolling to form a firm and stable base. Aggregate may consist of broken and crushed asphalt concrete or Portland cement concrete and may contain crushed aggregate base or other rock materials. The material may contain no more than 3 percent brick by weight as determined by California Test Method 202 as modified: Brick material retained on a No.4 sieve shall be identified visually and separated manually. Brick quantification shall be based on total weight of dry sample. Also, material retained on the 4.75 mm (No.4) sieve shall contain no more than 15 percent of particles (gravel) that have no more than one fractured face.

The Quality Requirements contained in Section 26-1.02A shall be modified to read:

**QUALITY REQUIREMENTS**

Test	Contract Compliance
Resistance (R-Value)	
Virgin Rock	78 Minimum
Crushed Miscellaneous	80 Minimum
Sand Equivalent	35 Minimum
Durability Index	35 Minimum
Percentage Wear	
100 Revolutions	15 Maximum
500 Revolutions	52 Maximum

Quantities of Aggregate Base will be paid for at the contract unit price per cubic yard and in accordance with the provisions of Sections 26-1.06 and 26-1.07 of the Standard Specifications.

**HOT MIX ASPHALT:**

The asphalt concrete shall be Type "A" and shall conform to the requirements of Section 39 of the Standard Specifications and the following:

Aggregate grading shall be three-quarter inch (3/4") maximum, medium for base course and half inch (1/2") maximum, medium for the final course.

The asphalt lift thickness table, as shown in Section 39-6.01, "General Requirements" of the Standard Specifications, is revised as follows:

Total Thickness Shown on Plans	Minimum No. of Layers	Top Layer Thickness (foot)		Next Lower Layer Thickness (foot)		All Other Lower Layer Thickness (foot)	
		Min.	Max.	Min.	Max.	Min.	Max.
0.24-foot or less <sup>a</sup>	1	-	-	-	-	-	-
0.25-foot	2 <sup>b</sup>	0.12	0.13	0.12	0.13	-	-
0.26 - 0.46 foot	2	0.12	0.21	0.14	0.25	-	-
0.47-foot or more	3 or more	0.15	0.21	0.15	0.25	0.17	0.25

Footnotes to asphalt thickness table are revised as follows:

- a. No Change.
- b. One layer of 0.25 foot thick may be placed as approved by the Engineer. When the Traffic Index specified is 5.5 or below, two layers shall be placed.

**Asphalts:**

Asphalt shall conform to the provisions in this Section, "Asphalts". Section 92, "Asphalts" of the Standard Specifications shall not apply.

Asphalt shall consist of refined petroleum or a mixture of refined liquid asphalt and refined solid asphalt, prepared from crude petroleum. Asphalt shall be:

- 1. Free from residues caused by the artificial distillation of coal, coal tar, or paraffin;
- 2. Free from water;
- 3. Homogeneous.

**General:**

The Contractor shall furnish asphalt in conformance with the State of California Department of transportation's Certification Program for Suppliers of Asphalt". The Department maintains the program requirements, procedures, and a list of approved suppliers at <http://www.dot.ca.gov/hq/esc/Translab/fpmcoc.htm>.

The Contractor shall ensure the safe transportation, storage, use, and disposal of asphalt.

The Contractor shall prevent the formation of carbonized particles caused by overheating asphalt during manufacturing or construction.

**Grade:**

Performance graded (PG) asphalt binder shall conform to the following:

Property	AASHTO Test Method	Specification Grade		
		PG 64-10	PG 64-16	PG 70-10
Original Binder				
Flash Point, Minimum °C	T48	230	230	230
Solubility, Minimum % <sup>b</sup>	T44	99	99	99
Viscosity at 135 °C, Maximum, Pa·s	T316	3.0	3.0	3.0
Dynamic Shear, Test Temp. at 10 rad/s, °C	T315	64	64	70
Minimum G <sup>*</sup> /sin(delta), kPa		1.00	1.00	1.00
RTFO Test <sup>c</sup> , Mass Loss, Maximum, %	T240	1.00	1.00	1.00
RTFO Test Aged Binder				
Dynamic Shear, Test Temp. at 10 rad/s, °C	T315	64	64	70
Minimum G <sup>*</sup> /sin(delta), kPa		2.20	2.20	2.20
Ductility at 25 °C Minimum, cm	T51	75	75	75
PAV <sup>f</sup> Aging, Temperature, °C	R28	100	100	110
RTFO Test and PAV Aged Binder				
Dynamic Shear, Test Temp. at 10 rad/s, °C	T315	31 <sup>d</sup>	28 <sup>d</sup>	34 <sup>d</sup>
Maximum G <sup>*</sup> /sin(delta), kPa		5000	5000	5000
Creep Stiffness, Test Temperature, °C	T313	0	-6	0
Maximum S-value, Mpa		300	300	300
Minimum M-value		0.300	0.300	0.300

**Notes:**

- a. Not used.
- b. The Engineer will waive this specification if the supplier is a Quality Supplier as defined by Department's "Certification Program for Suppliers of Asphalt".
- c. The Engineer will waive this specification if the supplier certifies the asphalt binder can be adequately pumped and mixed at temperatures meeting applicable safety standards.
- d. Test the sample at 3 °C higher if it fails at the specified test temperature. G<sup>\*</sup>/sin(delta) shall remain 5000 kPa maximum.
- e. "RTFO Test" means the asphaltic residue obtained using the Rolling Thin Film Oven Test, AASHTO Test Method T240 or ASTM Designation: D2827.
- f. "PAV" means Pressurized Aging Vessel.

Performance graded polymer modified asphalt binder (PG Polymer Modified) is:

Performance Graded Polymer Modified Asphalt Binder <sup>a</sup>

Property	AASHTO Test Method	Specification Grade		
		PG 58-34 PM	PG 64-28 PM	PG 76-22 PM
<b>Original Binder</b>				
Flash Point, Minimum °C	T 48	230	230	230
Solubility, Minimum % <sup>b</sup>	T 44 <sup>c</sup>	98.5	98.5	98.5
Viscosity at 135°C, <sup>d</sup> Maximum, Pa·s	T 316	3.0	3.0	3.0
Dynamic Shear, Test Temp. at 10 rad/s, °C Minimum G*/sin(delta), kPa	T 315	58 1.00	64 1.00	76 1.00
RTFO Test, Mass Loss, Maximum, %	T 240	1.00	1.00	1.00
<b>RTFO Test Aged Binder</b>				
Dynamic Shear, Test Temp. at 10 rad/s, °C Minimum G*/sin(delta), kPa	T 315	58 2.20	64 2.20	76 2.20
Dynamic Shear, Test Temp. at 10 rad/s, °C Maximum (delta), %	T 315	Note e 80	Note e 80	Note e 80
Elastic Recovery <sup>f</sup> , Test Temp., °C Minimum recovery, %	T 301	25 75	25 75	25 65
PAV <sup>g</sup> Aging, Temperature, °C	R 28	100	100	110
<b>RTFO Test and PAV Aged Binder</b>				
Dynamic Shear, Test Temp. at 10 rad/s, °C Maximum G*/sin(delta), kPa	T 315	16 5000	22 5000	31 5000
Creep Stiffness, Test Temperature, °C Maximum S-value, MPa Minimum M-value	T 313	-24 300 0.300	-18 300 0.300	-12 300 0.300

**Notes:**

- a. Do not modify PG Polymer Modifier using acid modification.
- b. The Engineer waives this specification if the supplier is a Quality Supplier as defined by the Department's "Certification Program for Suppliers of Asphalt".
- c. The Department allows ASTM D5546 instead of AASHTO T44.
- d. The Engineer waives this specification if the supplier certifies the asphalt binder can be adequately pumped and mixed at temperatures meeting applicable safety standards.
- e. Test temperature is the temperature at which G\*/sin(delta) is 2.2 kPa. A graph of log G\*/sin(delta) plotted against temperature may be used to determine the test temperature when G\*/sin(delta) is 2.2 Kpa. A graph of (delta) versus temperature may be used to determine delta at the temperature when G\*/sin(delta) is 2.2 kPa. The Engineer also accepts direct measurement of (delta) at the temperature when G\*/sin(delta) is 2.2 kPa.
- f. Test without a force ductility clamp may be performed.
- g. "PAV" means Pressurized Aging Vessel.

**Sampling:**

The Contractor shall provide a sampling device in the asphalt feed line connecting the plant storage tanks to the asphalt weighing system or spray bar. The sampling device shall be accessible between 24 and 30 inches above the platform. The Contractor shall provide a receptacle for flushing the sampling device.

The sampling device shall include a valve:

1. With a diameter between 1/2 and 3/4 inches;
2. Manufactured in a manner that a one-quart sample may be taken slowly at any time during plant operations;
3. Maintained in good condition.

**Replace Failed Valves:**

In the presence of the Engineer, the Contractor shall take 2 one-quart samples per operating day. The Contractor shall provide round friction top containers with one-quart capacity for storing samples.

**Applying Asphalt:**

Unless otherwise specified, the Contractor shall heat and apply asphalt in conformance with the provisions in Section 93, "Liquid Asphalts" of the Standard Specifications.

Section 39-2.01, "Asphalts" is replaced in its entirety with the followings:

Asphalt binder to be mixed with aggregate shall conform to the provisions in "Asphalts" of these Special Provisions.

The grade of asphalt binder shall be PG 64-10.

Liquid asphalt for prime coat shall conform to the provisions in Section 93, "Liquid Asphalts" of the Standard Specifications and shall be Grade 64-10 unless otherwise designated by the contract item or otherwise specified in the Special Provisions.

Asphaltic emulsion for tack coat shall conform to the provisions in Section 94, "Asphaltic Emulsion" of the Standard Specifications for the rapid-setting or slow-setting type and grade approved by the Engineer.

Section 39-3.01B (1) shall be amended to include:

Aggregate of the 3/4 inch or 1/2 inch maximum size and aggregate for asphalt concrete base shall be separated into 3 or more sizes and each size shall be stored in separate bins. If 3 sizes are used, one bin shall contain that portion of the material which will pass the maximum size specified and be retained on a 3/8 inch sieve; one bin shall contain that portion of the material

which will pass a 3/8 inch sieve and be retained on a No. 8 sieve; and one bin shall contain that portion of the material which will pass a No. 8 sieve.

Aggregate of 3/8 inch maximum size shall be separated into 2 sizes and each size shall be stored in separate bins. One bin shall contain that portion of the material which will pass the maximum size specified and be retained on a No. 8 sieve and one bin shall contain that portion of the material which will pass a No. 8 sieve.

The bin containing the fine material shall not contain more than 15 percent of material retained on the No. 8 sieve. The material in any of the other bins shall not contain more than 15 percent of material passing a No. 8 sieve. Failure to comply with this requirement shall be corrected immediately, and the material in the bins not meeting these requirements shall be re-screened or wasted.

All asphalt concrete for this project shall be supplied from one source unless approved by the Engineer. Said source shall be listed on the Contractors Source of Materials List as required in Section 6 of the Standard Specifications.

Asphaltic emulsion shall be furnished and applied as provided in Section 39-4.02.

In addition to the provisions in Section 39-5.01, "Spreading Equipment" of the Standard Specifications, asphalt paving equipment shall be equipped with automatic screed controls and a sensing device or devices.

When placing asphalt concrete to the lines and grades established by the Engineer, the automatic controls shall control the longitudinal grade and transverse slope of the screed. Grade and slope references shall be furnished, installed, and maintained by the Contractor. Should the Contractor elect to use a ski device, the minimum length of the ski device shall be 30 feet. The ski device shall be a rigid one piece unit and the entire length shall be utilized in activating the sensor.

When placing the initial mat of asphalt concrete on existing pavement, the end of the screed nearest the centerline shall be controlled by a sensor activated by a ski device not less than 30 feet. The end of the screed farthest from centerline shall be controlled by an automatic transverse slope device set to reproduce the cross slope designated by the Engineer, by a sensor activated by a similar ski device or as directed by the Engineer.

When paving contiguously with previously placed mats, the end of the screed adjacent to the previously placed mat shall be controlled by a sensor that responds to the grade of the previously placed mat and will reproduce the grade in the new mat within a 0.12 inch tolerance. The end of the screed farthest from the previously placed mat shall be controlled in the same way it was controlled when placing the initial mat.

Should the methods and equipment furnished by the Contractor fail to produce a layer of asphalt concrete conforming to the provisions, including straightedge tolerance, of Section 39-6.03, "Compacting" of the Standard Specifications or elsewhere in these Special Provisions, the paving operations shall be discontinued and the Contractor shall modify the equipment or methods, or furnish substitute equipment.

Should the automatic screed controls fail to operate properly during a day's work, the Contractor may manually control the spreading equipment for the remainder of that day. However, the equipment shall be corrected or replaced with alternative automatically controlled equipment conforming to the provisions in this section before starting another day's work.

**General Criteria For Profiling:**

In addition to the straightedge provisions in Section 39-6.03, "Compacting" of the Standard Specifications, asphalt concrete pavement shall conform to the surface tolerances specified herein.

The uppermost layer of asphalt concrete surfacing shall be profiled in the presence of the Engineer using a California Profilograph or equivalent in conformance with California Test 526 and as specified in these Special Provisions.

The California Profilograph or equivalent will not be required for the following areas of the pavement surface but shall conform to the straightedge requirements in Section 39-6.03, "Compacting" of the Standard Specifications:

1. Pavement with a total thickness less than 0.24 foot;
2. Pavement on horizontal curves with a centerline curve radius of less than 1,000 feet and the pavement within the superelevation transition on those curves;
3. Pavement placed in a single lift when required by the Special Provisions;
4. Pavement with extensive grade or cross slope correction which does not receive advance leveling operations in conformance with the provisions in Section 39-6.02, "Spreading" of the Standard Specifications;
5. Pavement for ramps and connectors with steep grades and high rates of superelevation, as determined by the Engineer;
6. Shoulders and miscellaneous areas.

The Contractor shall conform to California Test 526, except a zero (null) blanking band shall be used for determining the Profile Index. Prior to beginning profiles, the profilograph shall be calibrated in the presence of the Engineer. Two profiles shall be obtained within each traffic lane, 3 feet from and parallel with the edges of the lane.

Pavements profiled shall conform to the following Profile Index requirements:

1. Pavement on tangent alignment and pavement on horizontal curves having a centerline curve radius of 2,000 feet or more shall have a Profile Index of 0.16 foot or less for each 330 feet section profiled;
2. Pavement on horizontal curves having a centerline curve radius of 1,000 feet or more but less than 2,000 feet, including the pavement within the superelevation transition of



these curves, shall have a Profile Index of 0.32 foot or less for each 330 feet section profile;

3. Pavement within any 330 feet section, containing high point areas with deviations in excess of 0.025 foot in a length of 25 feet or less, when tested in conformance with the requirements in California Test 526, shall be corrected by the Contractor regardless of the Profile Index.

The Contractor shall complete initial runs of the profilograph prior to opening the pavement to public traffic. If initial profiles cannot be made prior to opening the pavement to public traffic, the initial runs of the profilograph shall be made the next day that traffic control is permitted for the area to be profiled.

Areas of the top surface of the uppermost layer of asphalt concrete pavement that do not meet the specified surface tolerances shall be brought within tolerance by abrasive grinding.

Abrasive grinding shall be performed to reduce individual deviations in excess of 0.025 foot, and to reduce the Profile Index of the pavement to be within the specified tolerance. Areas which have been subjected to abrasive grinding shall receive a seal coat. Deviations in excess of 0.025 foot which cannot be brought into specified tolerance by abrasive grinding shall be corrected by either (1) removal and replacement or (2) placing an overlay of asphalt concrete. The corrective method for each area shall be selected by the Contractor and shall be approved by the Engineer prior to beginning the corrective work. Replacement or overlay pavement not meeting the specified tolerances shall be corrected by the methods specified above. Corrective work shall be at the Contractor's expense. The Contractor shall run profilograms on the areas that have received abrasive grinding or corrective work until the final profilograms indicate the Profile Index of the area is within the specified tolerance.

When abrasive grinding is used to bring the top surface of the uppermost layer of asphalt concrete surfacing within the specified surface tolerances, additional abrasive grinding shall be performed as necessary to extend the area ground in each lateral direction so that the lateral limits of grinding are at a constant offset from, and parallel with, the nearest lane line or pavement edge, and in each longitudinal direction so that the grinding begins and ends at lines normal to the pavement centerline, within a ground area. Ground areas shall be neat rectangular areas of uniform surface appearance.

The original of the final profilograms that indicate the pavement surface is within the Profile Index specified shall become the property of the County and shall be delivered to the Engineer prior to acceptance of the contract.

## **PAYMENT**

The contract bid price paid per ton for Hot mix Asphalt shall include full compensation for furnishing all labor, tools, materials, equipment, and incidentals, and for doing all the work involved including the furnishing and applying asphaltic emulsion (paint binder).

Asphalt Concrete for road pavement, driveway, driveway tie-ins, asphalt concrete (miscellaneous area) and asphalt concrete dike will be paid for at a unit price per ton as a combined item, including mineral aggregate and asphalt binder in place on the roadbed.

The miscellaneous area shall be paid for at the contract price per square yard for Place Asphalt Concrete (Miscellaneous Area) in addition to the price paid for the materials involved.

The placing of Asphalt Concrete dike shall be paid in Linear Foot, and the quantities of dike will be paid at the contract price per ton for asphalt concrete.

At road connections and at limits of asphalt paving, existing pavement shall be header cut as shown on the plans or as directed by the Engineer. Full compensation for furnishing all labor, tools and doing all the work necessary including grinding, and sawcutting shall be considered as included in the contract prices paid per ton for the various asphalt concrete items and no additional compensation will be allowed therefor.

**COMPENSATION ADJUSTMENTS FOR PRICE INDEX FLUCTUATIONS:**

The provisions of this section shall apply only to the following contract items:

ITEM CODE	ITEM
390130	Hot Mix Asphalt

The compensation payable for asphalt binder used in hot mix asphalt will be increased or decreased in conformance with the provisions of this section for paving asphalt price fluctuations exceeding 10 percent ( $I_u/I_b$  is greater than 1.10 or less than 0.90) which occur during performance of the work.

The adjustment in compensation will be determined in conformance with the following formulae when the item of asphalt concrete is included in a monthly estimate:

A. Total monthly adjustment =  $AQ$

B. For an increase in paving asphalt price index exceeding 10 percent:

$$A = 0.90 (I_u/I_b - 1.10) I_b$$

C. For a decrease in paving asphalt price index exceeding 10 percent:

$$A = 0.90 (I_u/I_b - 0.90) I_b$$

D. Where:

A = Adjustment in dollars per ton of paving asphalt used to produce asphalt hot mix asphalt rounded to the nearest \$0.01.

$I_u$  = The California Statewide Paving Asphalt Price Index which is in effect on the first business day of the month within the pay period in which the quantity subject to adjustment was included in the estimate.

Ib = The California Statewide Paving Asphalt Price Index for the month in which the bid opening for the project occurred.

Q = Quantity in tons of asphalt binder that was used in producing the quantity of hot mix asphalt shown under "This Estimate" on the monthly estimate using the amount of asphalt binder determined by the Engineer.

The adjustment in compensation will also be subject to the following:

- A. The compensation adjustments provided herein will be shown separately on payment estimates. The Contractor shall be liable to the State for decreased compensation adjustments and the Department may deduct the amount thereof from moneys due or that may become due the Contractor.
- B. Compensation adjustments made under this section will be taken into account in making adjustments in conformance with the provisions in Section 4-1.03B, "Increased or Decreased Quantities" of the Standard Specifications.
- C. In the event of an overrun of contract time, adjustment in compensation for paving asphalt included in estimates during the overrun period will be determined using the California Statewide Paving Asphalt Price Index in effect on the first business day of the month within the pay period in which the overrun began.

The California Statewide Paving Asphalt Price Index is determined each month on the first business day of the month by the Department using the median of posted prices in effect as posted by Chevron, Mobil, and Unocal for the Buena Vista, Huntington Beach, Kern River, Long Beach, Midway Sunset, and Wilmington fields.

In the event that the companies discontinue posting their prices for a field, the Department will determine an index from the remaining posted prices. The Department reserves the right to include in the index determination the posted prices of additional fields.

The California Statewide Paving Asphalt Price Index is available on the Division of Engineering Services website at: [http://www.dot.ca.gov/hq/esc/oe/asphalt\\_index/astable.html](http://www.dot.ca.gov/hq/esc/oe/asphalt_index/astable.html).

#### **ASPHALT CONCRETE DIKE AND OVERSIDE DRAIN:**

Asphalt concrete dikes and overside drain shall be constructed in accordance to the plans, standard plans and specifications, Riverside County Road Improvement Standards And Specifications, as specified and as directed by the Engineer.

The pay quantity of asphalt concrete dikes and overside drains, the placing of which are to be paid for as a separate item of work in addition to the price paid for the asphalt concrete material.

The placing of Asphalt Concrete (AC) overside drain shall be paid per each, and AC dikes shall be paid per linear foot and the quantities will be considered as included for hot mix asphalt. The transition of AC dike shall be paid in the same manner as place AC dike.

HMA shall be Type "A" and shall conform to the requirements of Section 39 of the Standard Specifications and aggregate grading shall be three-quarter inch (3/8") maximum.

Asphalt binder to be mixed with the aggregate shall be PG 64-10, or as directed by the Engineer.

**PAYMENT**

The contract unit bid price paid per linear foot for placing Asphalt Concrete Dike including removal of existing AC dike and per each for Asphalt Concrete Overside Drain, shall include full compensation for furnishing all labor, material, tools, and equipment and doing all the work involved in furnishing HMAC and placing and compacting and no additional compensation will be allowed therefor.

**PLACE ASPHALT CONCRETE (MISCELLANEOUS AREA):**

Asphalt Concrete driveways shall be constructed as shown on the plans and as directed by the Engineer.

The pay quantity of asphalt concrete driveways, the placing of which are to be paid for as a separate item of work in addition to the price paid for the asphalt concrete material.

Asphalt binder to be mixed with the aggregate shall be PG 64-10 in accordance with the Special Provisions for Asphalts, or as directed by the Engineer.

**PAYMENT**

The contract unit bid price paid per square yard for Place Asphalt Concrete (Miscellaneous Area), which price shall include full compensation for furnishing all labor, material, tools, and equipment and doing all the work involved, complete in place and compacting, and no additional compensation will be allowed therefor.

**ADJUST MANHOLE TO GRADE:**

Existing manholes shall be adjusted to finish grade with materials similar in quality to those in the original structure in accordance with the applicable provisions of Sections 15-2 of the Standard Specifications and these Special Provisions.

After the manhole frame has been removed, the top of the structure shall be carefully trimmed to provide a suitable foundation for the new material.

Nothing in these Special Provisions shall relieve the Contractor from his responsibilities as provided in Section 7-1.09, "Public Safety" of the Standard Specifications.

After completion of the work, the structure covers, frames, grade rings and old concrete collar debris that were removed from the roadbed shall become the property of the Contractor.

## **PAYMENT**

The contract unit bid price paid per each for Adjust Manhole to Grade shall include full compensation for furnishing all labor, materials, tools, equipment, and incidentals, for doing all the work involved including the installation of the concrete ring and no additional compensation will be allowed therefor.

### **ADJUST SEWER CLEANOUT, WATER METER AND FIRE HYDRANT:**

Adjustment of sewer cleanout, water meters and fire hydrant owned by the Rubidoux Water District (RCSD) shall be performed in accordance with the RCSD Standards and Special Provisions, and as directed by the Engineer.

## **PAYMENT**

Full compensation, including labor, equipment and materials, shall be at the unit bid price, and no additional compensation will be allowed therefore.

### **REPAIR SEWER AND WATER LATERAL:**

The existing shallow sewer and water laterals if damaged due to the construction activities shall be repaired in accordance with the RCSD Standards and Special Provisions, and as directed by the Engineer.

## **PAYMENT**

Full compensation, including labor, equipment and materials, excavation and backfill shall be at the unit bid price, and no additional compensation will be allowed therefore.

### **RELOCATE MAIL BOX :**

Private mail and newspaper boxes shall be removed as directed by the Engineer, and reset on temporary portable mounts consisting of timber posts supported in five-gallon cans or buckets, in accordance with Section 15 of the Standard Specifications and these Special Provisions.

During construction operations, the portable mount shall be moved as necessary to clear the Contractor's operations, but at all times shall be easily accessible for mail delivery. When construction is complete, the mounts shall be reset on a final position outside the shoulder line as directed by the Engineer.

The bucket or can to be used to form the pedestal, if neat appearing in the opinion of the Engineer, may be left on the pedestal; otherwise, it shall be removed and disposed of.

Existing groups of mailboxes, on single-post or multiple post supports shall be removed and reset on two-post portable mounts as herein specified for single-post mountings and shall be provided with a supporting cross member between the tops of the portable mounts. Two-post installations shall be considered as two units for payment purposes.

#### **PAYMENT**

The contract unit price for Relocate Mailbox shall include full compensation for furnishing all labor, material, tools, equipment, and incidentals and for doing all the work involved in removing the boxes, constructing the portable mounts, installing the boxes on the mounts, moving and setting up the portable mounts as required, and placing the mounts in final position, including all necessary concrete, excavation, and backfill, as specified in the Standard Specifications and these Special Provisions, and as directed by the Engineer

#### **MASONRY BLOCK WALL (REMOVE/REPLACE):**

Masonry block wall (Remove and Replace) shall be constructed in accordance with the Caltrans Standard Plans, and as directed by the Engineer.

Removed block wall shall be the property of the Contractor and shall be disposed of by the Contractor, as provided in Section 7-1.13 of the Standard Specifications.

#### **PAYMENT**

Full compensation for removing, disposing of existing, and reconstruction of Block Wall shall be considered as included in the Lump Sum bid price paid for Clearing and Grubbing, and no additional compensation will be allowed.

#### **CONCRETE CURB AND GUTTER, DRIVEWAY , DRIVEWAY APPROACH:**

Concrete curb and gutter, driveway, and driveway approaches shall be constructed in accordance with the County Road Improvement Standards And Specifications, or as directed by the Engineer and in conformance with Section 51, 73 and 90 of Standard Specifications, except as herein modified:

Class 2 concrete shall be used for curb and gutter, driveways and driveway approach, driveway tie-ins.

Preparation of subgrade for the concrete structures shall be done in conformance with the requirements of Section 73-1.02 of the Standard Specifications.

The placement of aggregate base material is required under all concrete in accordance with County Road Improvement Standards and Specifications.

Excess material resulting from the excavation of the subgrade shall be disposed of as elsewhere provided in these Special Specifications. Full compensation for the removal of

existing concrete and/or asphalt concrete structures as shown on the plan to be removed shall be included in the contract lump sum price paid for Roadway Excavation.

The Contractor is responsible for meeting all requirements of the Americans with Disability Act (ADA).

Construction of curb and gutter, driveways and driveway approaches, shall include, but not be limited to, the following:

- 1) Removal and disposal of existing sidewalk, curb, and/or curb and gutter, and existing soil and aggregate as required;
- 2) Establishing grades, and assuring that all grades are met;
- 3) Performing all grading and compaction – including all required aggregate import, as directed by the Engineer and in accordance with County Standard 403;
- 4) Construction of new sidewalk, curb, and/or curb and gutter, driveways and curb ramps;
- 5) All scoring/grooving and required saw cutting;
- 6) Repair of existing asphalt and PCC surfacing;
- 7) Installing 1/2" wide expansion joints;
- 8) All landscaping, and related work, to return the area adjacent to the curb ramp, Curb and gutter, driveway approaches and driveways to its original condition and to conform the area to the new improvements;

## **PAYMENT**

The contract unit bid prices paid per linear foot for Curb and Gutter, and, square foot for Driveways and Driveway approaches, shall include full compensation for furnishing all labor, equipment, materials and tools, and incidentals, and for doing all the work involved in the construction and complete in place including the furnishing and placing of expansion joints within the right of way and as directed by the Engineer on private property and removal of existing curb shown on the plan to be removed, no additional compensation will be allowed therefor.

## **REMOVE TRAFFIC STRIPE AND PAVEMENT MARKING:**

Where blast cleaning/grinding is used for the removal of painted/thermoplastic traffic stripe, and such removal operation is being performed within 10 feet of a lane occupied by public traffic, the residue including dust shall be removed immediately after contact between the sand and the surface being treated. Such removal shall be by wet abrasive blasting, hydro-blasting or vacuum blasting, and shall comply with AQMD regulations. No water from hydro-blasting operations shall be allowed to enter the storm drain system.

Blast cleaning/grinding for removal of traffic stripe shall be feathered out to irregular and varying widths.

Pavement markings shall be removed by blast cleaning a rectangular area, rather than just lettering or markings, so the old message cannot be identified.

After removal of traffic stripes and pavement markings, a fog seal coat shall be applied in conformance with the provisions in Section 37, "Bituminous Seals" of the Standard Specifications and the following:

If removal of existing striping is performed more than 24 hours prior to final striping, the Contractor shall place reflective temporary striping tape throughout the limits of sandblasting, to provide channelization of traffic, for all lanes of travel.

Temporary striping tape shall be removed subsequent to final striping.

Nothing in these Special Provisions shall relieve the Contractor from his responsibilities as provided in Section 7-1.09, "Public Safety," of the Standard Specifications.

#### **PAYMENT**

Full compensation for initial Remove Traffic Stripe and Pavement marking shall be considered as included in the contract price paid for roadway excavation, and no additional compensation will be allowed therefor.

#### **FINISHING ROADWAY:**

Finishing roadway shall conform to Section 22 of the Standard Specifications and these Special Provisions.

#### **PAYMENT**

Full compensation for finishing roadway shall be paid for on a lump sum basis and no additional compensation will be allowed therefore.

#### **OBJECT MARKER:**

Object markers shall be installed in accordance with the plans, the Caltrans Standard Plans or as directed by the Engineer.

The contract unit bid prices paid per each for Object Marker (Type L-1) shall include full compensation for furnishing all labor, materials, tools, equipment, and incidentals and for doing all the work involved and no additional compensation will be allowed therefor.



### **PAINT TRAFFIC STRIPE:**

Painting traffic stripe shall conform to the provisions in Sections 84-1, "General" and 84-3, "Painted Traffic Stripes and Pavement Markings" of the Standard Specifications and these Special Provisions.

Traffic striping shall be applied in two coats with airless equipment and shall be performed with a roadliner truck mounted striping machine. Where the configuration or location of a traffic stripe is such that the use of a roadliner truck mounted striping machine is unsuitable, traffic striping and glass spheres may be applied by other methods and equipment approved by the Engineer.

Newly painted traffic striping shall be protected from damage by public traffic or other causes until the paint is thoroughly dry. Any newly painted traffic striping which are damaged as a result of the construction, including wheel markings by public traffic and the construction equipment, shall be repainted by the Contractor and any associated removals shall be performed as called for in these Special Provisions.

### **PAYMENT**

The contract price paid per linear foot for Paint Traffic Stripe (2 Coats) shall include full compensation for furnishing all labor, materials, tools, equipment, and incidentals, and for doing all the work involved in painting traffic stripe (regardless of the number, widths, and types of individual stripes involved in each traffic stripe) including any necessary cat tracks, dribble lines any layout work, complete in place as shown on the plans, as specified in the Standard Specifications and these Special Provisions, and as directed by the Engineer.

### **THERMOPLASTIC PAVEMENT MARKING:**

Thermoplastic pavement markings shall conform to the provisions in Sections 84-1, "General," and 84-2, "Thermoplastic Traffic Stripes and Pavement Markings," of the Standard Specifications and these Special Provisions.

### **PAYMENT**

The contract price paid per square foot for Thermoplastic Pavement Marking shall be paid by the square foot price bid and shall include full compensation for furnishing all labor, materials, tools, equipment, and incidentals and doing all the work necessary to place the pavement markings complete in place and no additional compensation will be allowed.



## **REFERENCE DRAWINGS**



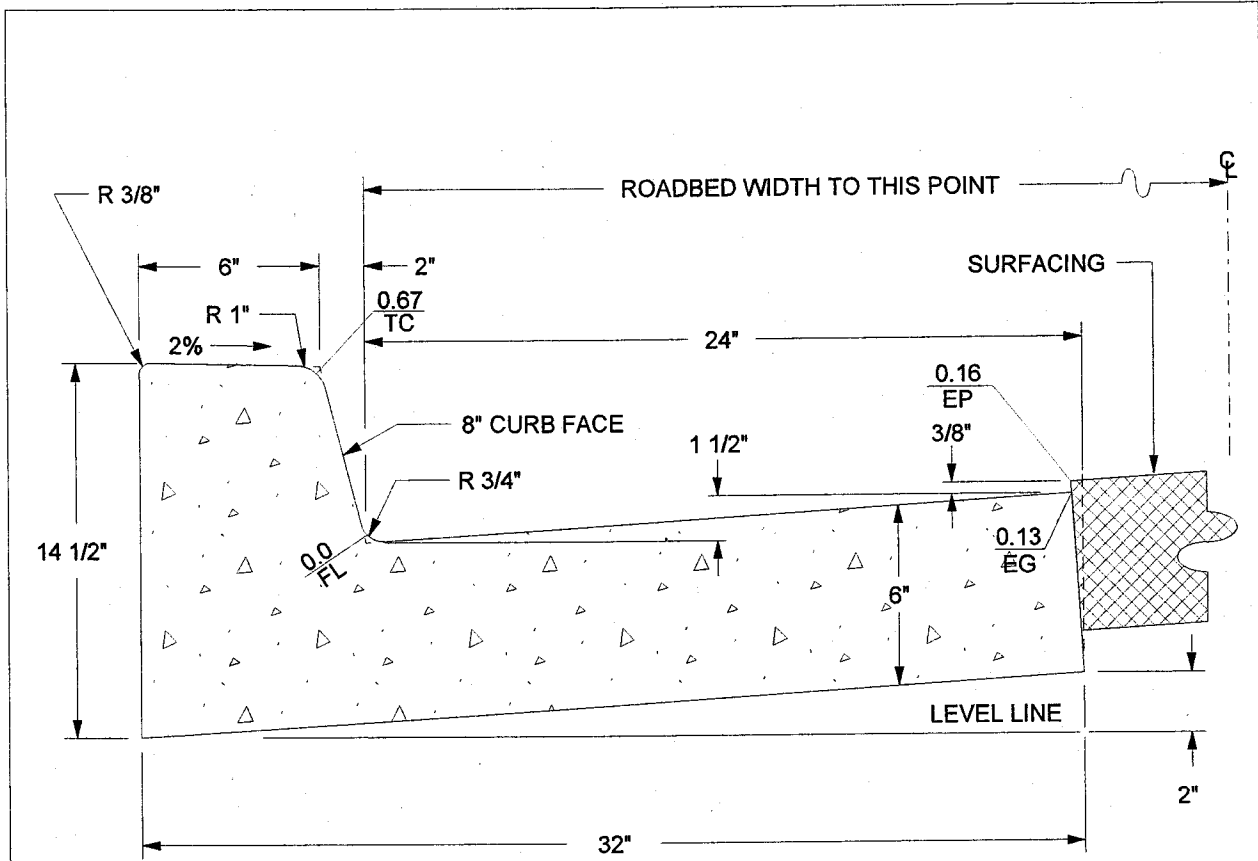

CLASS "B" CONCRETE  
 1.73 CU. FT. / L.F.  
 1 CU. YD. = 15.60 L.F.

ABBREVIATIONS:  
 TC = TOP OF CURB  
 FL = FLOWLINE  
 EG = EDGE OF GUTTER  
 EP = EDGE OF PAVEMENT

APPROVED BY:								COUNTY OF RIVERSIDE			
<i>George A. Johnson</i> DATE: 05/01/07 DIRECTOR OF TRANSPORTATION GEORGE A. JOHNSON, RCE 42328								TYPE A-8 CURB			
REVISIONS		REV.	BY:	APR'D	DATE	REV.	BY:	APR'D	DATE	STANDARD NO. 201	
8-71, 9-88		1				4					
2-90, 11-04		2				5					
		3				6					



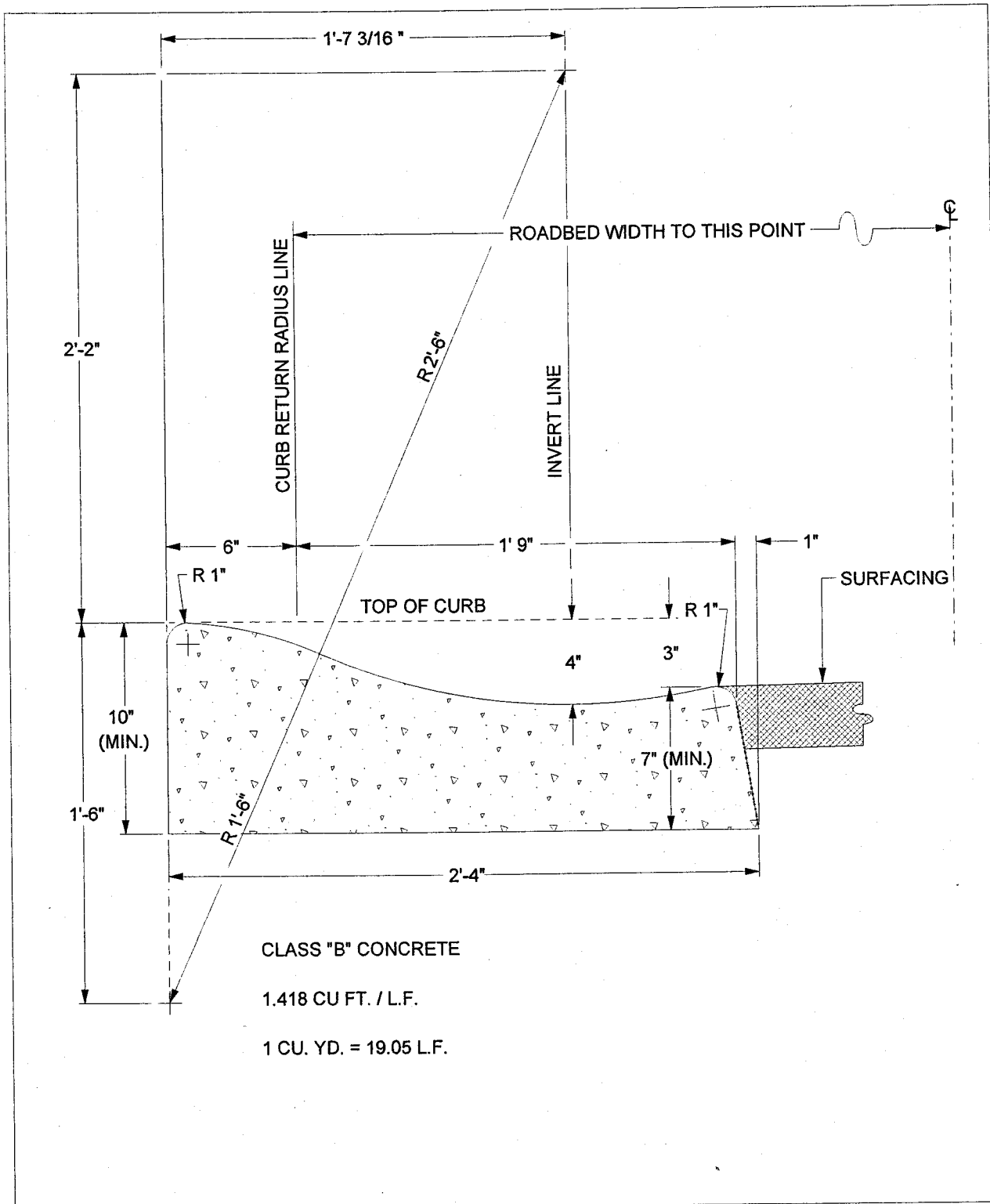

APPROVED BY:										COUNTY OF RIVERSIDE				
<i>George A. Johnson</i> DIRECTOR OF TRANSPORTATION GEORGE A. JOHNSON, RCE 42328										DATE: 05/01/07				
REVISIONS		REV.	BY:	APR'D	DATE	REV.	BY:	APR'D	DATE	STANDARD NO. 202				
2-71, 3-82		1				4								
2-90, 11-04		2				5								
		3				6								





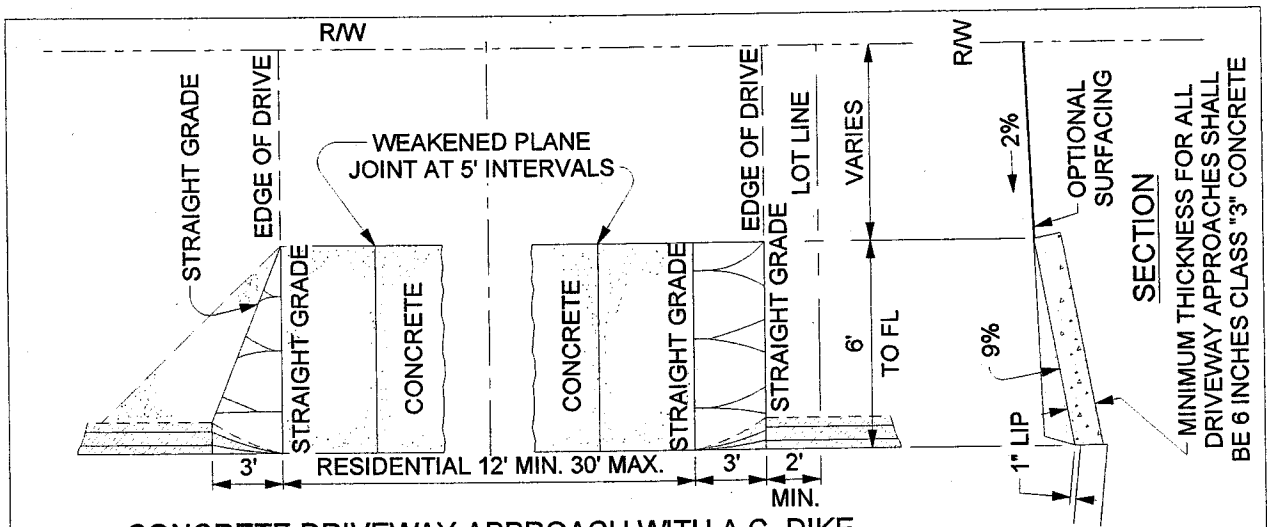

**CONCRETE DRIVEWAY APPROACH WITH A.C. DIKE**  
(NOT APPLICABLE TO INTERIM DIKE LOCATION.)

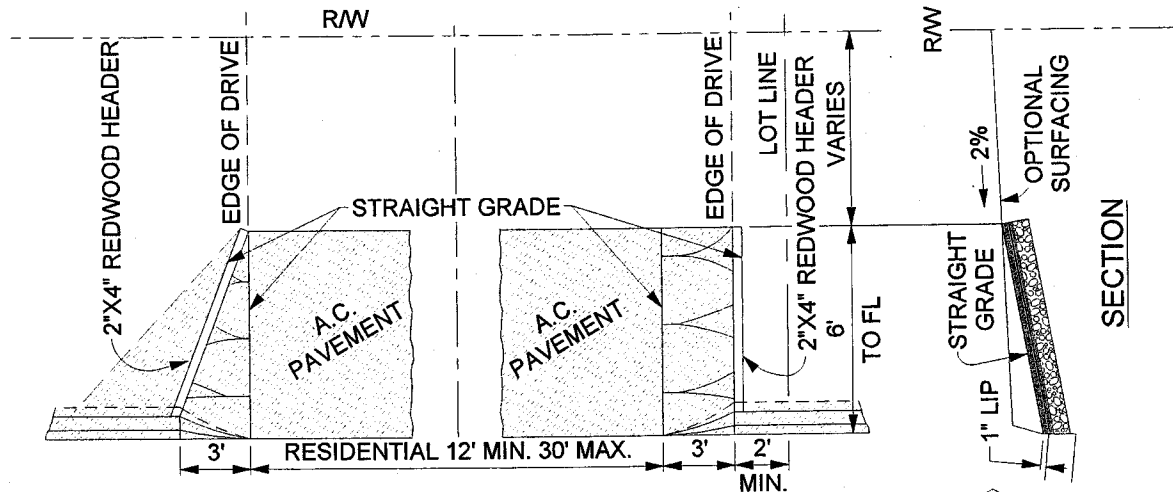

**ASPHALTIC CONCRETE DRIVEWAY APPROACH WITH A.C. DIKE**

**NOTES:**

1. ALL CONSTRUCTION SHALL BE 2-1/2" MIN. THICKNESS ASPHALTIC CONCRETE ON 4" MIN. THICKNESS CLASS 2 OR CLASS 3 BASE, OR 3-1/2" THICKNESS A.C. ON NATIVE SOIL.
2. 20' OF FULL HEIGHT DIKE REQUIRED BETWEEN DRIVEWAYS WITHIN ANY ONE PROPERTY UNLESS OTHERWISE PERMITTED.

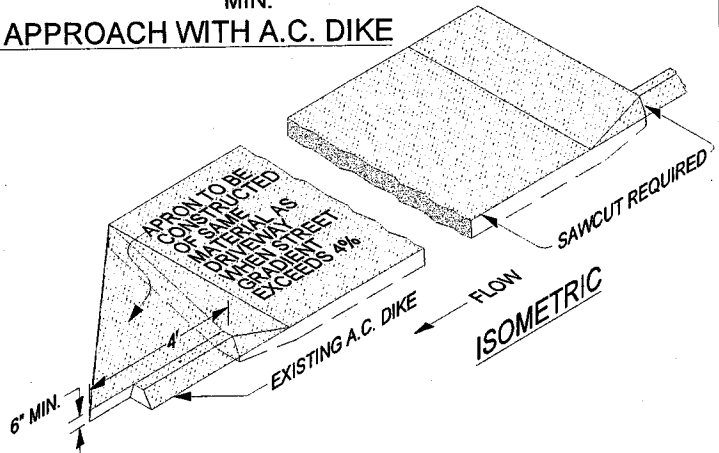

NOT TO SCALE

APPROVED BY:

*George A. Johnson*  
DIRECTOR OF TRANSPORTATION  
GEORGE A. JOHNSON, RCE 42328

DATE: 11/15/04



COUNTY OF RIVERSIDE

**RESIDENTIAL DRIVEWAY WITH A.C. DIKE**

STANDARD NO. 206

REVISIONS	REV.	BY:	APR'D	DATE	REV.	BY:	APR'D	DATE
8-77, 5-80	1				4			
3-82, 2-90	2				5			
12-97, 11-04	3				6			



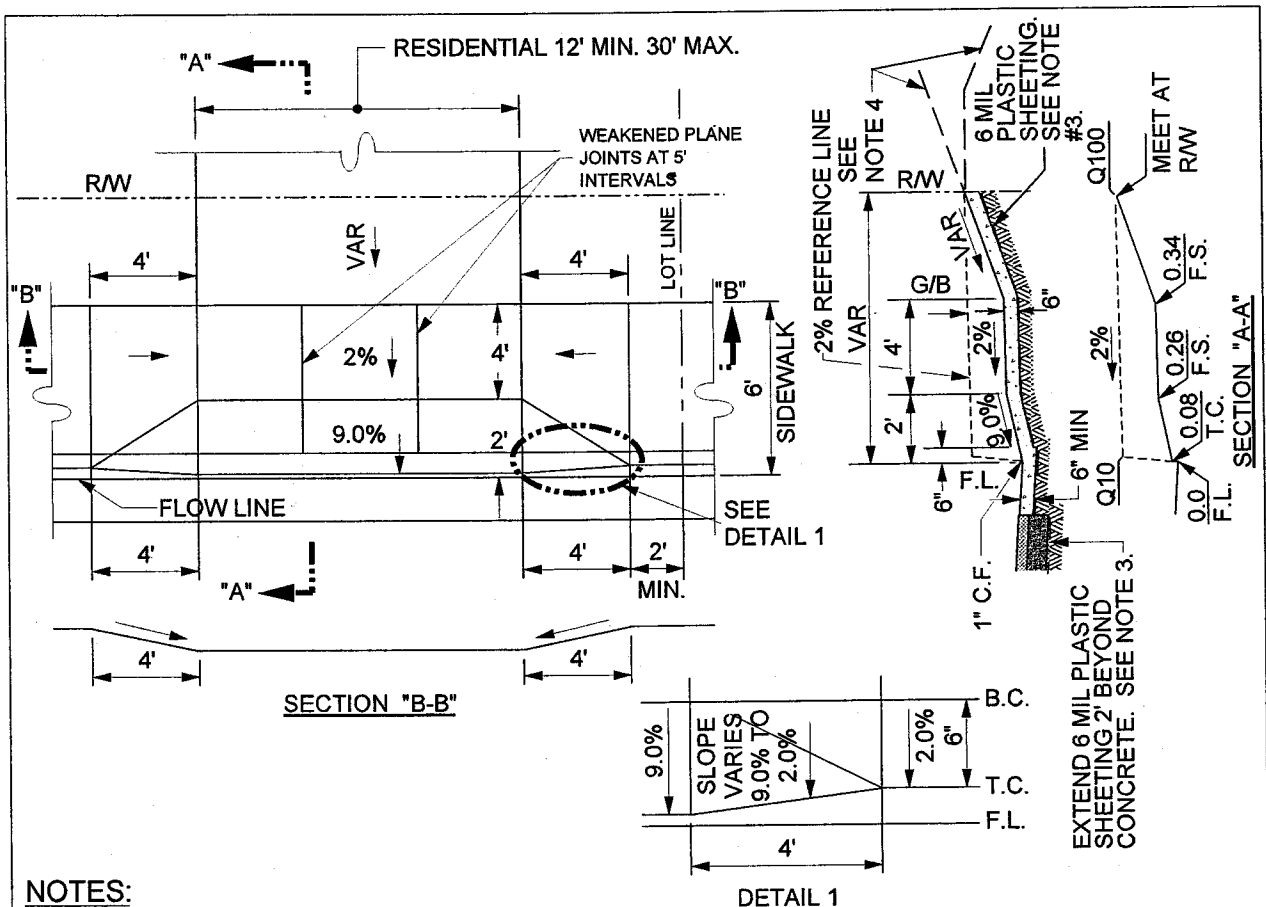

**NOTES:**

1. ALL CONSTRUCTION SHALL BE CLASS "3" CONCRETE.
2. 20' OF FULL-HEIGHT CURB REQUIRED BETWEEN DRIVEWAYS WITHIN ANY ONE PROPERTY FRONTAGE.
3. USE 6 MIL PLASTIC SHEETING WHEN ABUTTING SOIL HAS A HIGH SULFATE CONTENT, SPECIAL CONSIDERATIONS ARE REQUIRED. SEE SPECIFICATIONS (SECTION 16.04).
4. CONSTRUCT THE PROFILE GRADE OF THE PRIVATE ON-SITE DRIVEWAY SO THAT IT PROVIDES SMOOTH VEHICLE ACCESS OVER THE DRIVE APPROACH.

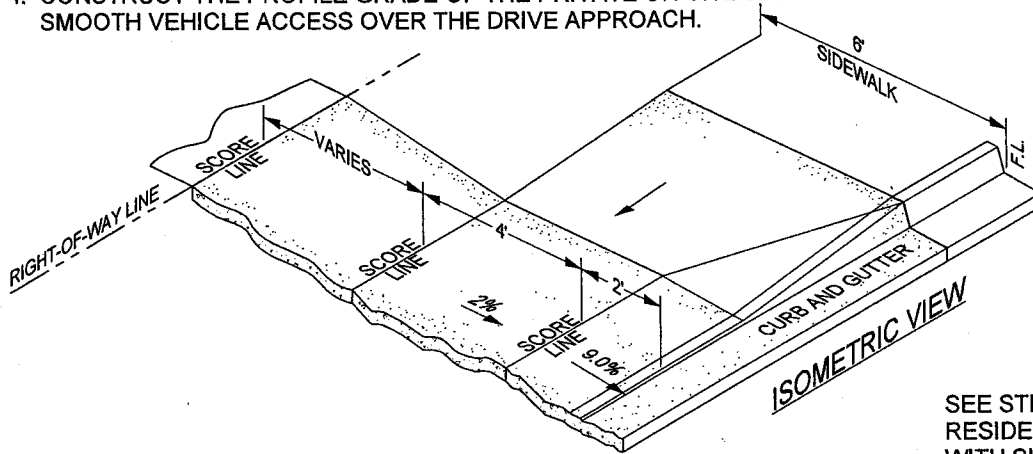

NOT TO SCALE

SEE STD NO. 213 FOR RESIDENTIAL DRIVEWAY WITH SIDEWALK AT R/W

APPROVED BY:

*George A. Johnson*  
 DIRECTOR OF TRANSPORTATION  
 GEORGE A. JOHNSON, RCE 42328

DATE: 11/15/04

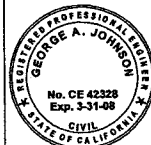

COUNTY OF RIVERSIDE

**RESIDENTIAL DRIVEWAY WITH SIDEWALK AT CURB**

REVISIONS		REV.	BY:	APR'D	DATE	REV.	BY:	APR'D	DATE
8-71, 8-77	11-04	1				4			
5-80, 2-82		2				5			
2-90, 12-97		3				6			

STANDARD NO. 207

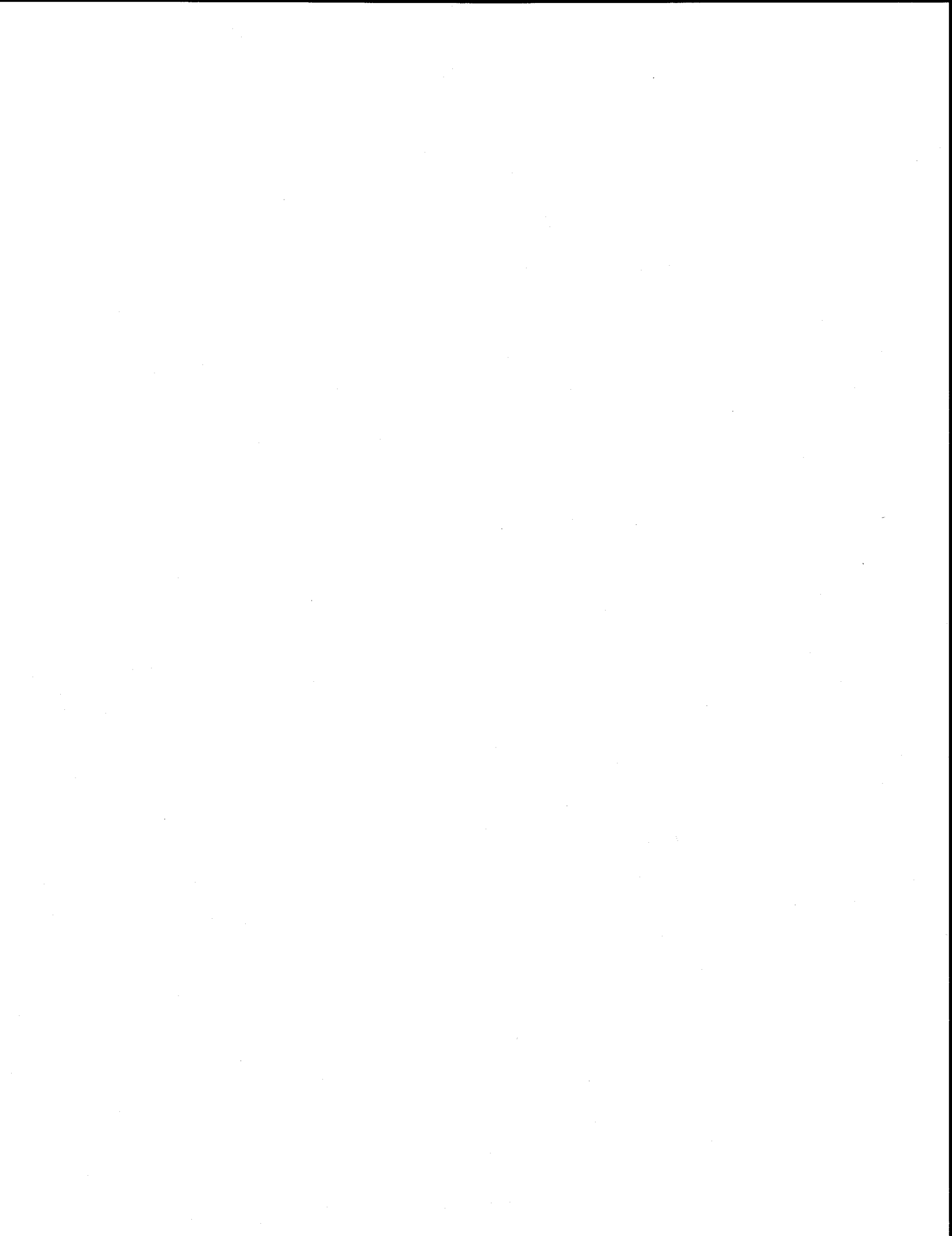

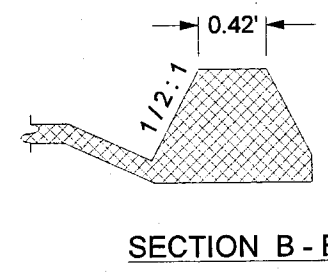
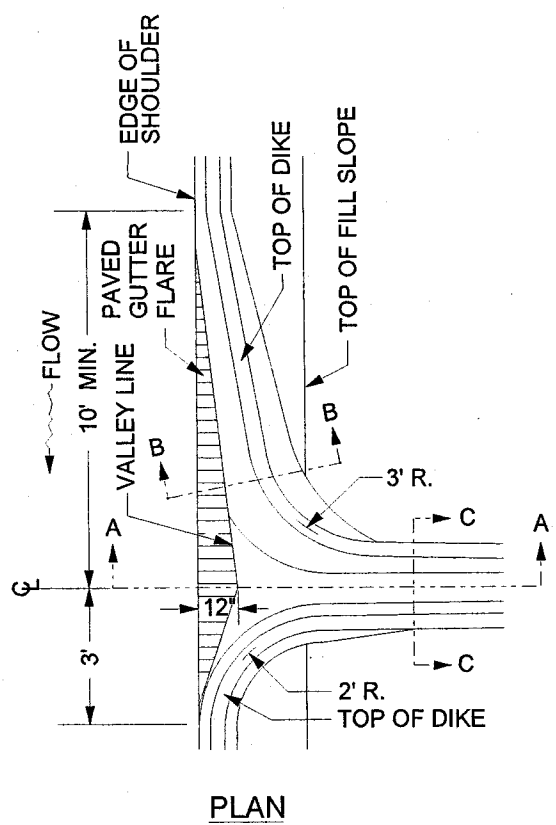
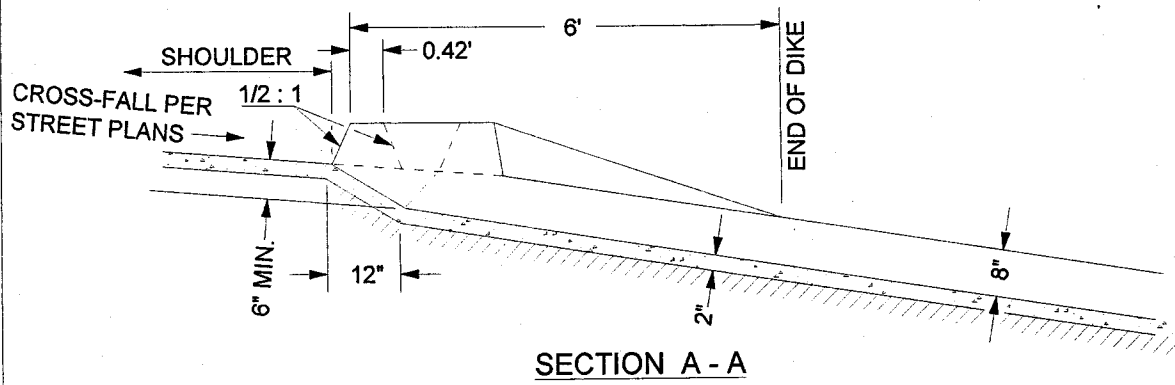

NOTE:  
 CROSS - SECTION OF SLOPE DITCH MAY BE SEMICIRCULAR, VEE, OR TRAPEZOIDAL.  
 MIN. TOP WIDTH = 25", MIN. DEPTH = 8".

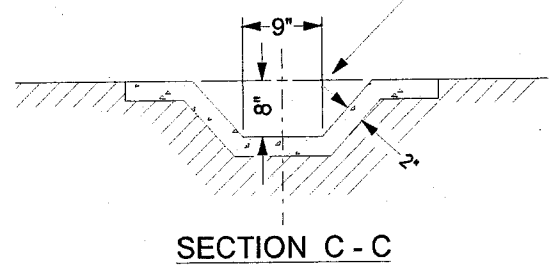

TO BE USED ON FILL SLOPES FLATTER THAN 4 : 1.  
 USE MIN. 10' LENGTH OF GUTTER ON BOTH SIDES  
 IN A SAG LOCATION. USE PIPE DOWNDRAINS FOR  
 SLOPES STEEPER THAN 4 : 1 SLOPES.

NOT TO SCALE

APPROVED BY:  
  
 DIRECTOR OF TRANSPORTATION  
 GEORGE A. JOHNSON, RCE 42328

DATE: 05/01/07

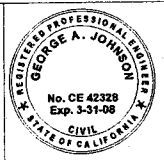

COUNTY OF RIVERSIDE

**ASPHALT CONCRETE  
 OVERSIDE DRAIN**

REVISIONS	REV.	BY:	APR'D	DATE	REV.	BY:	APR'D	DATE
8-18-77, 2-82	1				4			
11-04	2				5			
	3				6			

STANDARD NO. 306



DATE COUNTY ROUTE DISTRICT SHEET TOTAL SHEETS

REGISTERED CIVIL ENGINEER  
 Michael J. Jones  
 No. 41788  
 Exp. 12-31-11

MAY 20, 2011  
 PLUS APPROVAL DATE  
 THE ENGINEER SHALL BE RESPONSIBLE FOR THE ACCURACY OF THE SHEET.

REGISTERED PROFESSIONAL ENGINEER  
 No. 41788  
 Exp. 12-31-11

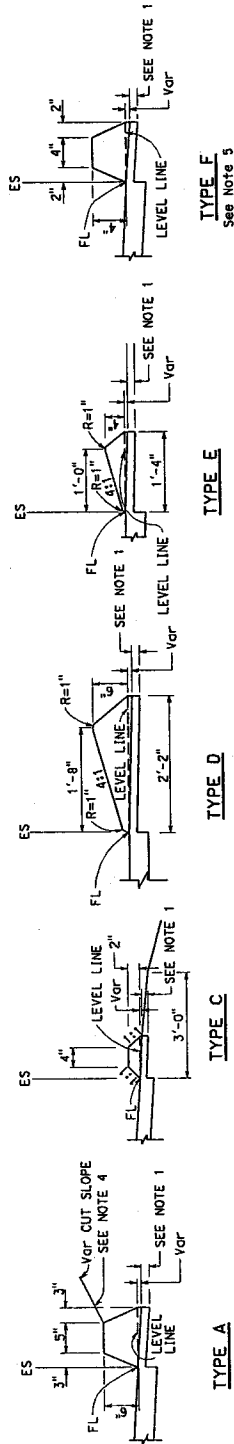

**DIKES**

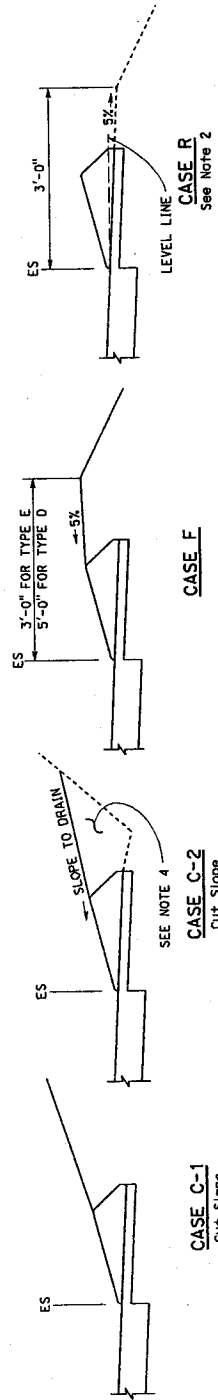

**TYPE D AND E BACKFILL DETAILS**

**DIKE QUANTITIES**

TYPE	CUBIC YARDS PER LINEAR FOOT
A	0.0735
C	0.0038
D	0.0293
E	0.0130
F	0.0066

Quantities based on 5% cross slope.

- NOTES:**
- For HMA shoulders only, extend top layer of HMA placed on the shoulder under dike with no joint at the ES. For projects with OGFC shoulders, do not extend OGFC under dike. See project plans for modified dike detail.
  - Case R applies to retrofit only projects where restrictive conditions do not provide enough width for Case F backfill.
  - Type A dike only to be used where restrictive slope conditions do not provide enough width to use Type D or Type E dike.
  - Fill and compact with excavated material to top of dike.
  - Use Type F dike where dike is required with guard railing installations. See Standard Plan A7704 for dike positioning details.

STATE OF CALIFORNIA  
 DEPARTMENT OF TRANSPORTATION  
**HOT MIX ASPHALT DIKES**  
 NO SCALE

**A87B**

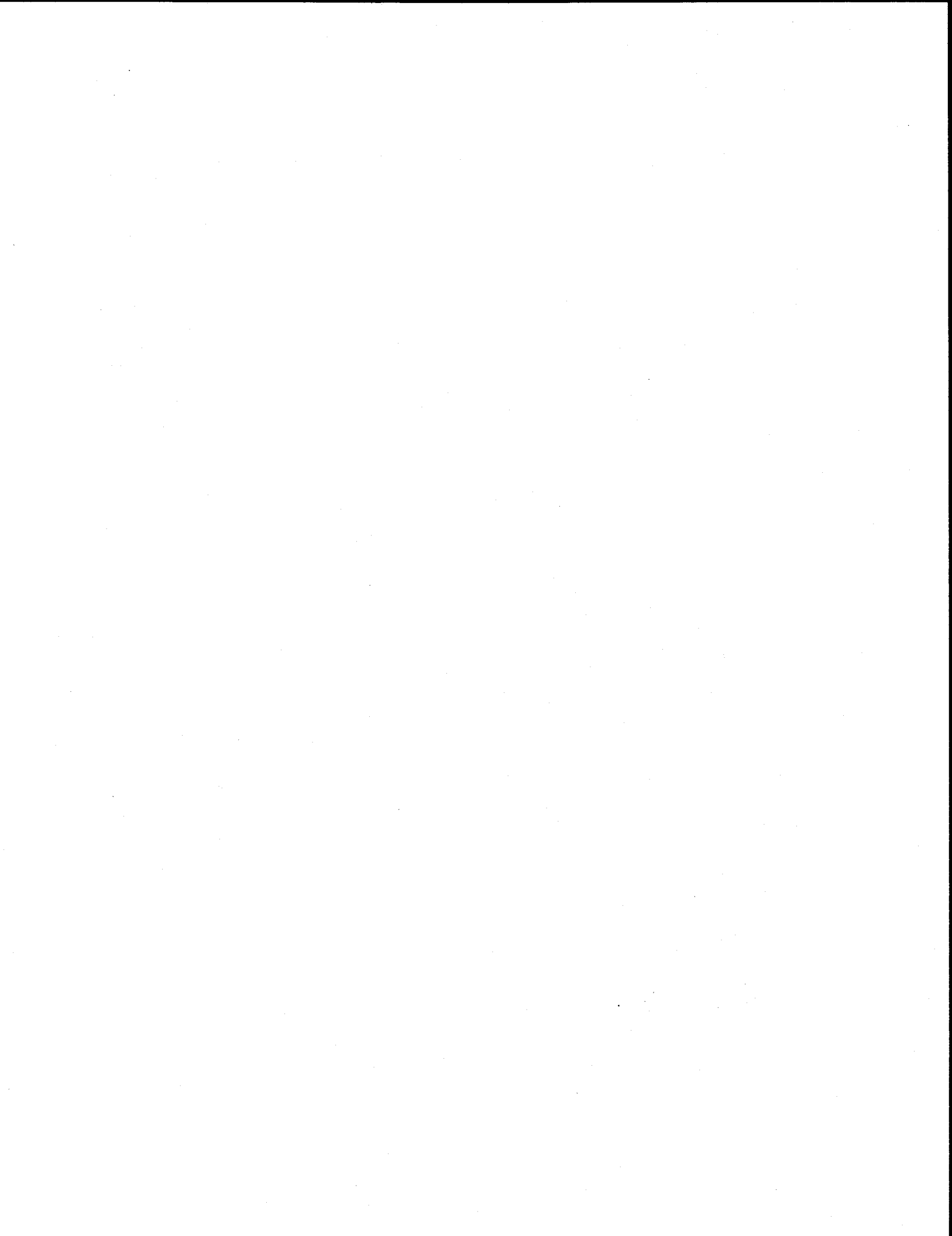









OFFICE OF  
CLERK OF THE BOARD OF SUPERVISORS  
1st FLOOR, COUNTY ADMINISTRATIVE CENTER  
P.O. BOX 1147, 4080 LEMON STREET  
RIVERSIDE, CA 92502-1147  
PHONE: (951) 955-1060  
FAX: (951) 955-1071

KECIA HARPER-IHEM  
Clerk of the Board of Supervisors  
  
KIMBERLY A. RECTOR  
Assistant Clerk of the Board

March 22, 2012

THE PRESS ENTERPRISE  
ATTN: LEGALS  
PO BOX 792  
RIVERSIDE, CA 92501

FAX (951) 368-9018  
E-MAIL: [legals@pe.com](mailto:legals@pe.com)

**RE: NOTICE INVITING BIDS: SKYVIEW ROAD C1-0534**

To Whom It May Concern:

Attached is a copy for publication in your newspaper for **TEN (10) TIMES:**

Tuesday	- March 27, 2012	Sunday	- April 1, 2012
Wednesday	- March 28, 2012	Monday	- April 2, 2012
Thursday	- March 29, 2012	Tuesday	- April 3, 2012
Friday	- March 30, 2012	Wednesday	- April 4, 2012
Saturday	- March 31, 2012	Thursday	- April 5, 2012

We require your affidavit of publication immediately upon completion of the last publication.

Your invoice must be submitted to this office in duplicate, WITH TWO CLIPPINGS OF THE PUBLICATION.

**NOTE: PLEASE COMPOSE THIS PUBLICATION INTO A SINGLE COLUMN FORMAT.**

Thank you in advance for your assistance and expertise.

Sincerely,

*Mcgil*

Cecilia Gil, Board Assistant to  
KECIA HARPER-IHEM, CLERK OF THE BOARD

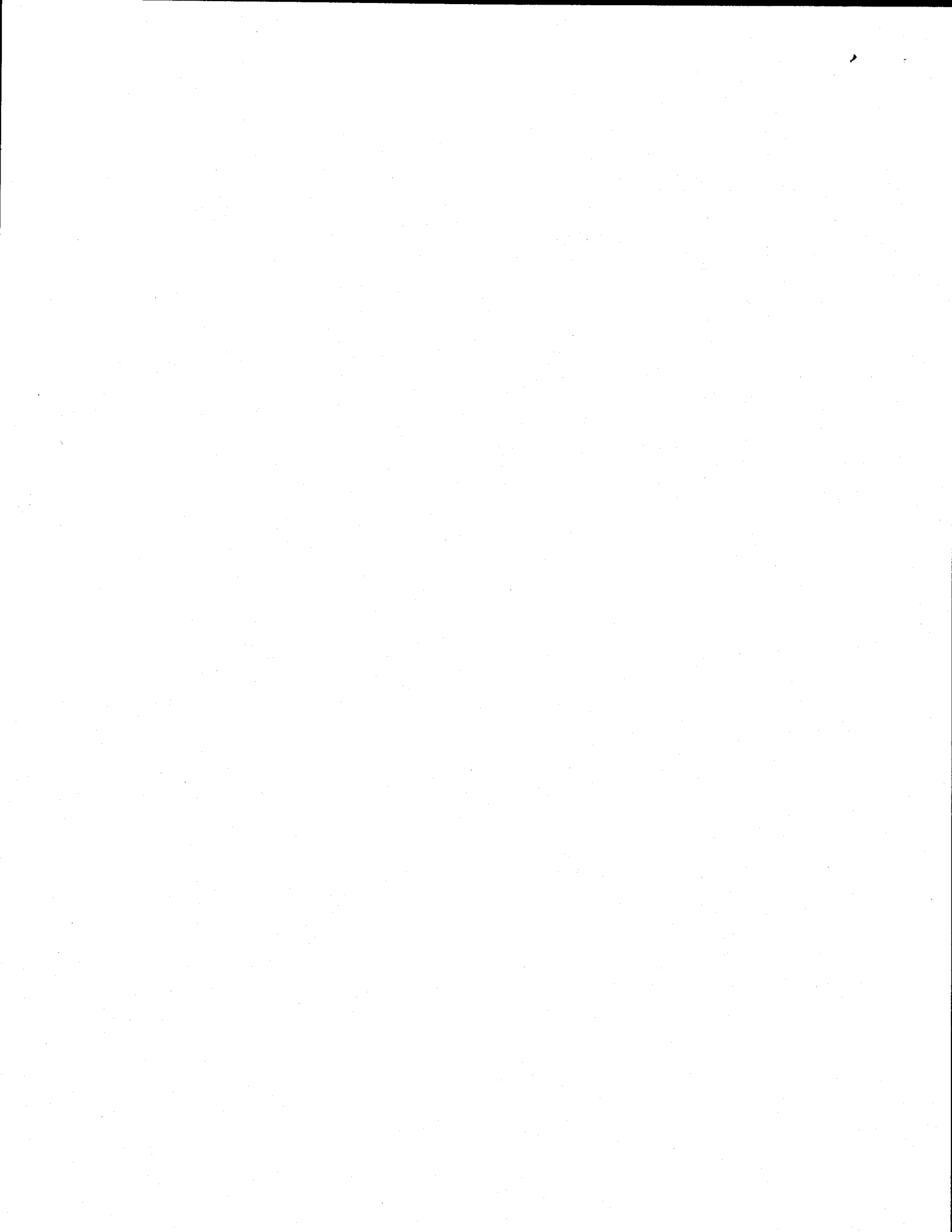



OFFICE OF  
CLERK OF THE BOARD OF SUPERVISORS  
1st FLOOR, COUNTY ADMINISTRATIVE CENTER  
P.O. BOX 1147, 4080 LEMON STREET  
RIVERSIDE, CA 92502-1147  
PHONE: (951) 955-1060  
FAX: (951) 955-1071

KECIA HARPER-IHEM  
Clerk of the Board of Supervisors

KIMBERLY A. RECTOR  
Assistant Clerk of the Board

March 22, 2012

RIVERSIDE COUNTY RECORD  
ATTN: LEGALS  
PO BOX 3187  
RIVERSIDE, CA 92519

FAX (951) 685-2961  
E-MAIL: recordmde@aol.com

**RE: NOTICE INVITING BIDS: SKYVIEW ROAD C1-0534**

To Whom It May Concern:

Attached is a copy for publication in your newspaper for **TWO (2) TIMES:**

Thursday - March 29, 2012

Thursday - April 5, 2012

We require your affidavit of publication immediately upon completion of the last publication.

Your invoice must be submitted to this office in duplicate, WITH TWO CLIPPINGS OF THE PUBLICATION.

**NOTE: PLEASE COMPOSE THIS PUBLICATION INTO A SINGLE COLUMN FORMAT.**

Thank you in advance for your assistance and expertise.

Sincerely,

*Mcgil*

Cecilia Gil, Board Assistant to  
KECIA HARPER-IHEM, CLERK OF THE BOARD



**NOTICE INVITING BIDS**

County of Riverside, herein called Owner, invites sealed proposals for:

**SKYVIEW ROAD  
RECONSTRUCTION PROJECT  
CITY OF JURUPA VALLEY  
RIVERSIDE COUNTY**

**PROJECT NO. C1-0534**

Proposal shall be delivered to the Riverside County Transportation Department, 14<sup>th</sup> Street Annex, 3525 14<sup>th</sup> Street, Riverside, California 92501, telephone (951) 955-6780 not later than 2:00 p.m., on Wednesday, April 11, 2012, to be promptly opened in public at said address. Each proposal shall be in accordance with plans, specifications, and other contract documents, dated February 2012, and prepared by County of Riverside, whose address is same as the above, from whom they may be obtained upon deposit of \$35 per set plus mailing. No refund. Prospective bidders may preview the plans, specifications and other contract documents, at no charge prior to purchase, at the above noted location.

The Contractor is required to have a Class "A" license or "C-12" license at the time of bid submission.

Engineering Estimate	\$243,000.00 - \$283,000.00
Bid Bond	10%
Performance Bond	100%
Payment Bond	100%
Working Days	20 Working Days

[www.tlma.co.riverside.ca.us/trans](http://www.tlma.co.riverside.ca.us/trans)

Dated: March 22, 2012

Kecia Harper-Ihem, Clerk of the Board  
By: Cecilia Gil, Board Assistant

