

955



**SUBMITTAL TO THE BOARD OF SUPERVISORS
COUNTY OF RIVERSIDE, STATE OF CALIFORNIA**

FROM: TLMA - Transportation Department

SUBMITTAL DATE:
May 3, 2012

SUBJECT: Construction of traffic signal at the intersection of Murrieta Hot Springs Road and Willows Avenue, Temecula area.

RECOMMENDED MOTION: That the Board of Supervisors:

1. Approve the plans and specifications for the construction of a traffic signal at the intersection of Murrieta Hot Springs Road and Willows Avenue, Temecula area.
2. Authorize the Clerk to advertise for bids to be received in the office of the Director of Transportation up to the hour of 2:00 PM, Wednesday, June 27, 2012, at which time bids will be opened.

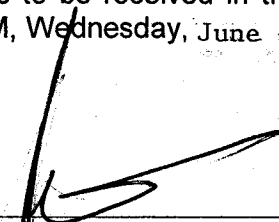

 Juan C. Perez
 Director of Transportation

JCP:jj:sb
(Continued On Attached Page)

FINANCIAL DATA	Current F.Y. Total Cost:	\$ 234,000	In Current Year Budget:	Yes
	Current F.Y. Net County Cost:	\$ 0	Budget Adjustment:	No
	Annual Net County Cost:	\$ 0	For Fiscal Year:	2011/2012

SOURCE OF FUNDS: West County DIF Signal Mitigation Fund (100%),	Positions To Be Deleted Per A-30	<input type="checkbox"/>
There are no General Funds used in this project.	Requires 4/5 Vote	<input type="checkbox"/>

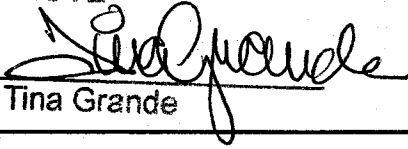
C.E.O. RECOMMENDATION:

APPROVE
 BY: 
 Tina Grande

County Executive Office Signature

MINUTES OF THE BOARD OF SUPERVISORS

On motion of Supervisor Tavaglione, seconded by Supervisor Benoit and duly carried by unanimous vote, IT WAS ORDERED that the above matter is approved as recommended.

Ayes: Buster, Tavaglione, Stone, Benoit and Ashley
 Nays: None
 Absent: None
 Date: June 5, 2012
 xc: Transp.

Kecia Harper-Ihem
 Clerk of the Board
 BY: 
 Deputy

Prev. Agn. Ref. | District: 3/3 | Agenda Number:

ATTACHMENTS FILED
WITH THE CLERK OF THE BOARD

3.62

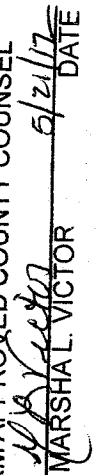
FORM APPROVED COUNTY COUNSEL
 BY: 
 MARSHAL L. VICTOR
 DATE: 5/21/12

Departmental Concurrence

Policy
 Consent
 Policy
 Consent
 Dept't Recomm.:
 Per Exec. Ofc.:

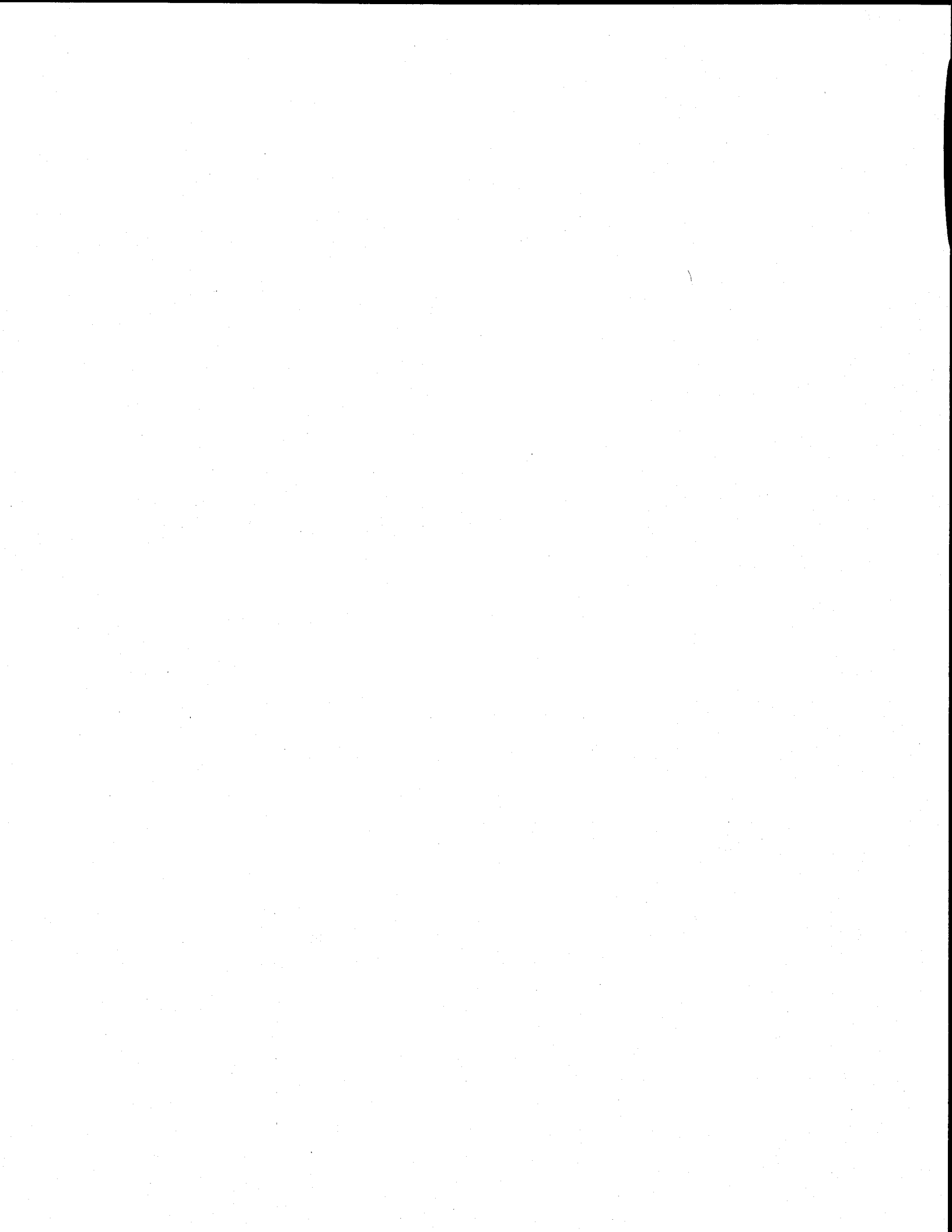

The Honorable Board of Supervisors

RE: Construction of traffic signal at the intersection of Murrieta Hot Springs Road and Willows Avenue, Temecula area.

May 3, 2012

Page 2 of 2

BACKGROUND: The Transportation Improvement Program provides for the construction of a traffic signal at the intersection of Murrieta Hot Springs Road and Willows Avenue, in the Temecula area. The proposed traffic signal will improve safety by providing protected traffic movements and pedestrian crossings. Additionally, the storm drain inlets and median nose are being modified to provide a clear path for the proposed marked crosswalk. New ADA compliant ramps will be installed at all four curb returns of the proposed traffic signal. This project will also provide striping and signing improvements at the intersection.

Annual traffic signal operation and maintenance costs are estimated at \$5,500 to be funded from gas tax.

The submitted plans and specifications have been approved as to form by County Counsel.

Environmental clearance is complete.

Project Number: C2-0128



MURRIETA HOT SPRINGS ROAD AND WILLOWS AVENUE TRAFFIC SIGNAL PROJECT

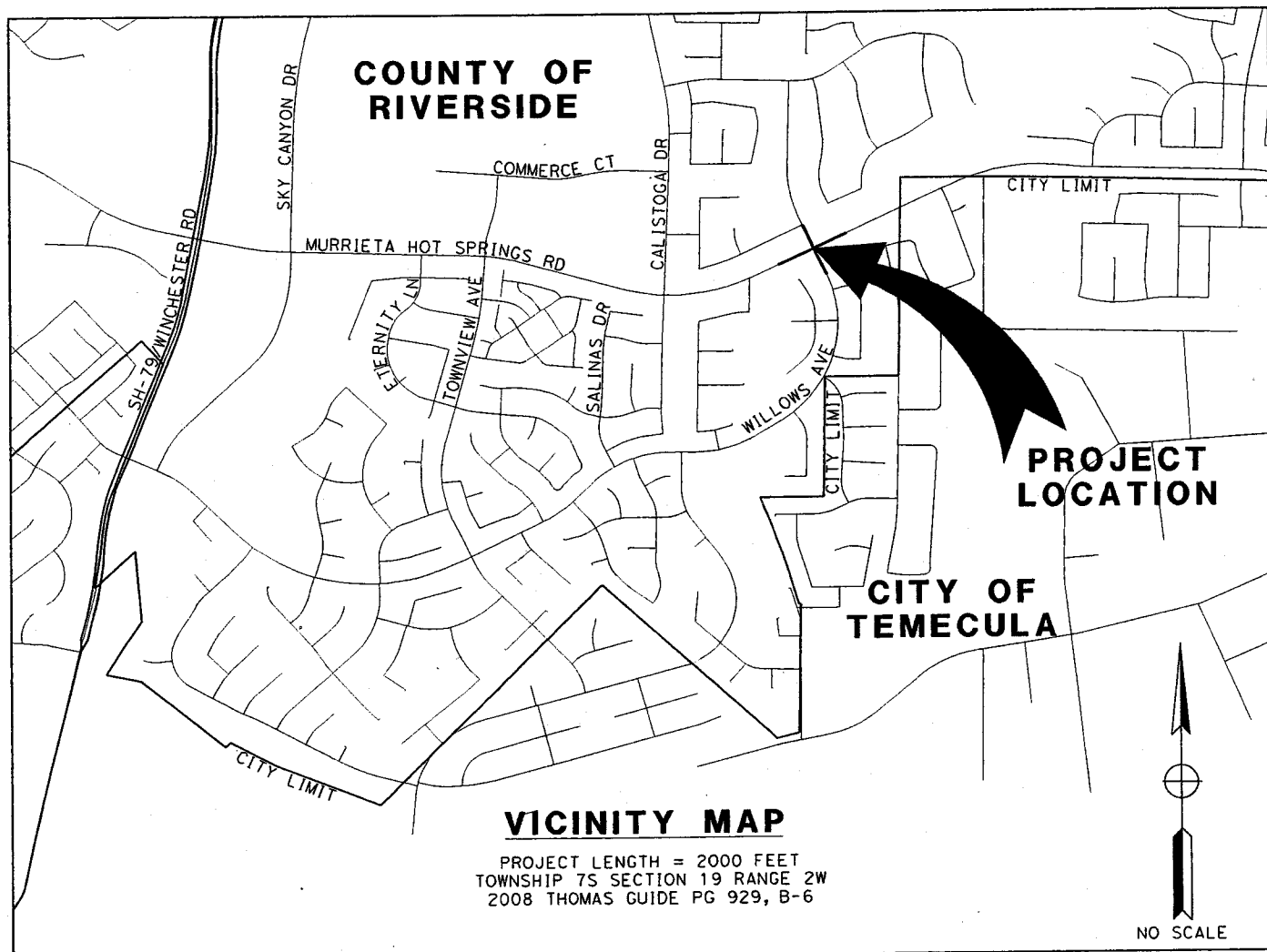
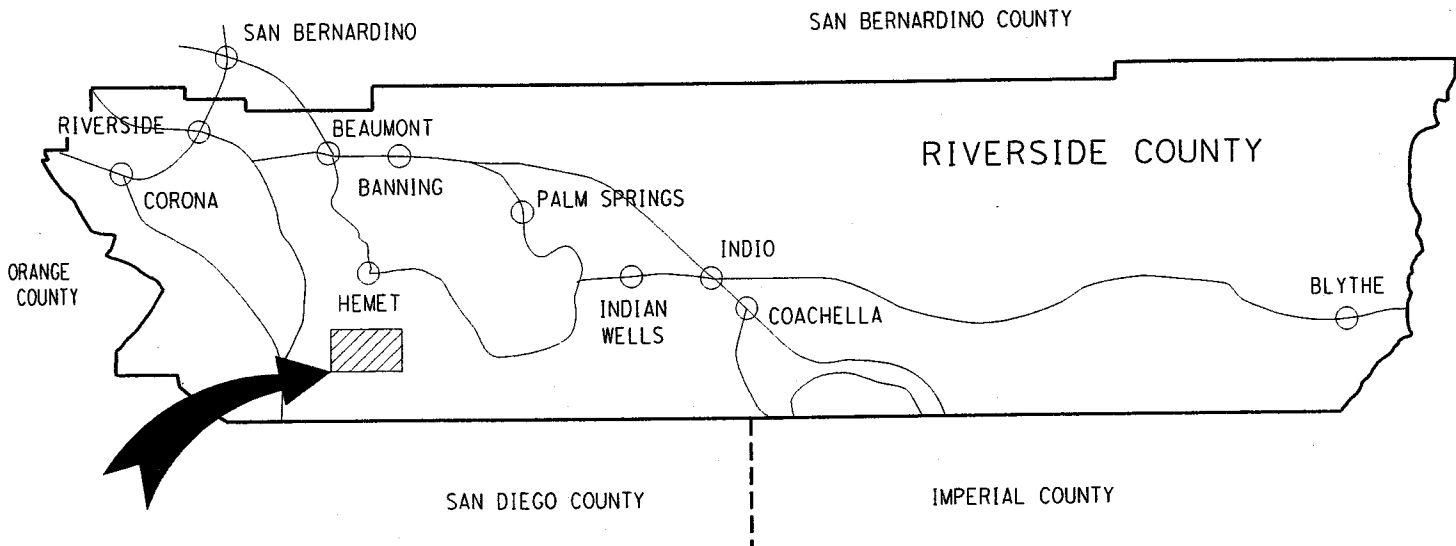



NOTICE INVITING BIDS

County of Riverside, herein called Owner, invites sealed proposals for:

**TRAFFIC SIGNAL AND LIGHTING PROJECT
AT THE INTERSECTION OF
MURRIETA HOT SPRINGS ROAD AND WILLOWS AVENUE**

PROJECT No. C2-0128

Proposal shall be delivered to the Riverside County Transportation Department, 14th Street Annex, 3525 14th Street, Riverside, California 92501, telephone (951) 955-6780 not later than 2:00 p.m., on Wednesday, June 27, 2012, to be promptly opened in public at said address. Each proposal shall be in accordance with plans, specifications, and other contract documents, dated April 2012, and prepared by County of Riverside, whose address is same as the above, from whom they may be obtained upon deposit of \$35 per set plus mailing. No refund. Prospective bidders may preview the plans, specifications and other contract documents, at no charge prior to purchase, at the above noted location.

The Contractor is required to have a Class "A" license or "C-10" license at the time of bid submission.

Engineering Estimate:	\$208,800.00 - \$243,600.00
Bid Bond	10 %
Performance Bond	100 %
Payment Bond	100 %
Working Days	35 Working Days

www.tlma.co.riverside.ca.us/trans

JUN - 5 2012 *B. 62*



NOTICE INVITING BIDS

County of Riverside, herein called Owner, invites sealed proposals for:

**TRAFFIC SIGNAL AND LIGHTING PROJECT
AT THE INTERSECTION OF
MURRIETA HOT SPRINGS ROAD AND WILLOWS AVENUE**

PROJECT No. C2-0128

Proposal shall be delivered to the Riverside County Transportation Department, 14th Street Annex, 3525 14th Street, Riverside, California 92501, telephone (951) 955-6780 not later than 2:00 p.m., on Wednesday, June 27, 2012, to be promptly opened in public at said address. Each proposal shall be in accordance with plans, specifications, and other contract documents, dated April 2012, and prepared by County of Riverside, whose address is same as the above, from whom they may be obtained upon deposit of \$35 per set plus mailing. No refund. Prospective bidders may preview the plans, specifications and other contract documents, at no charge prior to purchase, at the above noted location.

The Contractor is required to have a Class "A" license or "C-10" license at the time of bid submission.

Engineering Estimate:	\$208,800.00 - \$243,600.00
Bid Bond	10 %
Performance Bond	100 %
Payment Bond	100 %
Working Days	35 Working Days

www.tlma.co.riverside.ca.us/trans

JUN - 5 2012 362



**TRAFFIC SIGNAL AND LIGHTING PROJECT
AT THE INTERSECTION OF
MURRIETA HOT SPRINGS ROAD AND WILLOWS AVENUE
PROJECT NO. C2-0128**

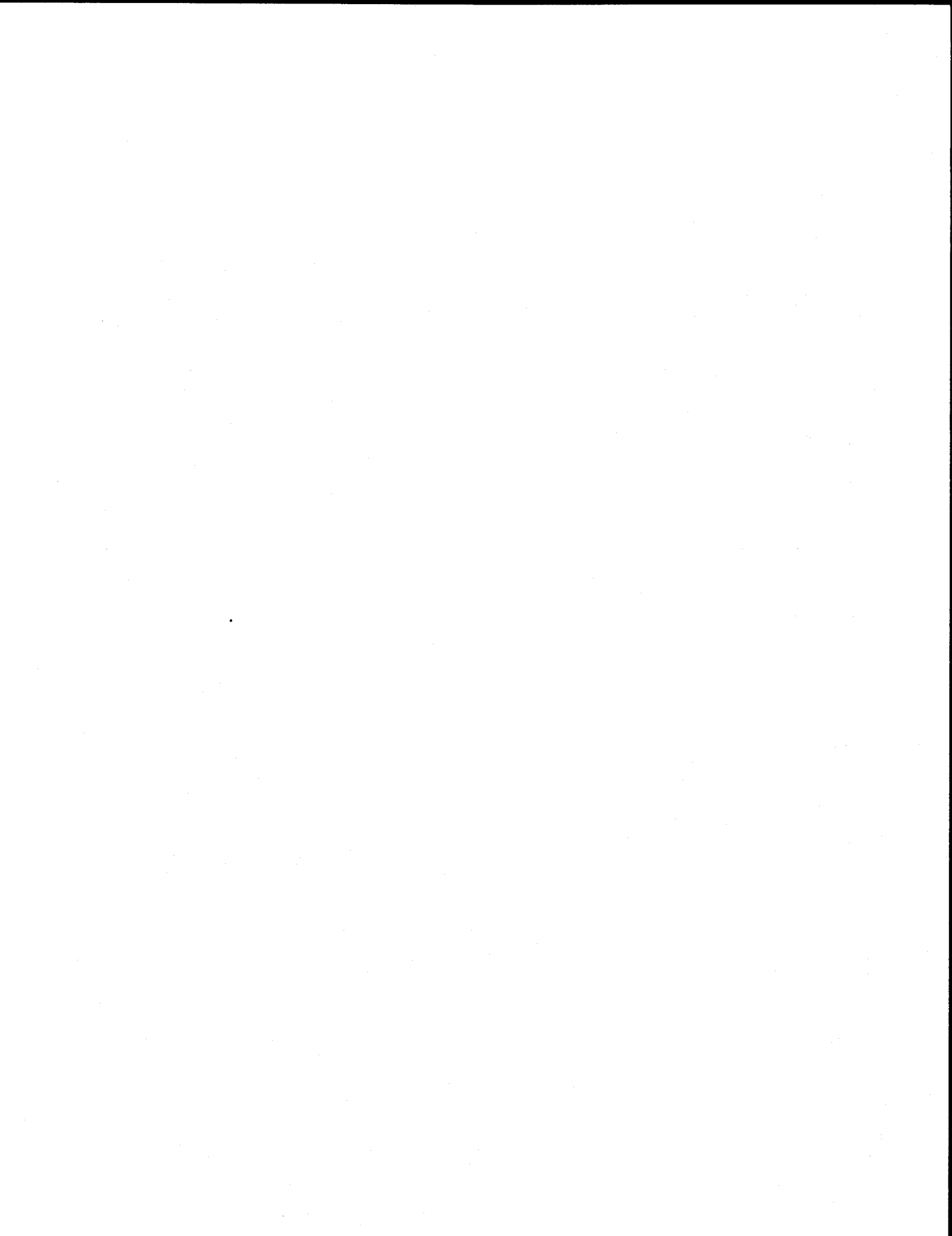

SPECIFICATIONS AND CONTRACT DOCUMENTS

for

TRAFFIC SIGNAL AND LIGHTING

AT THE INTERSECTION OF

MURRIETA HOT SPRINGS ROAD AND WILLOWS AVENUE

Project No. **C2-0128**

Contract Approvals:

Approved by:



Khalid Nasim,
Engineering Division Manager

4/17/2012

Date

Engineering Certification:

These specifications, special provisions, and estimates have been prepared by or under the direction of the following Registered Civil Engineers:



Dowling Tsai,
County Project Manager
R.C.E. C52870

4/17/12

Date



SPECIFICATIONS AND CONTRACT DOCUMENTS

for

**TRAFFIC SIGNAL AND LIGHTING
AT THE INTERSECTION OF
MURRIETA HOT SPRINGS ROAD AND WILLOWS AVENUE**

Project No. **C2-0128**

Water Pollution Control:

Reviewed and Recommended by:

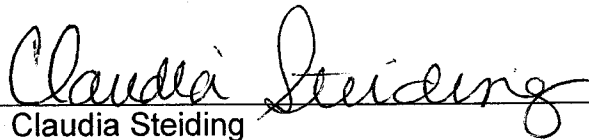

Claudia Steiding

Senior Transportation Planner/NPDES
Coordinator

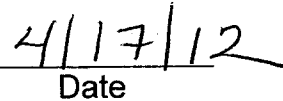

Date



TABLE OF CONTENTS

	<u>PAGE</u>
Notice Inviting Bids	
Instruction to Bidders	A1-A6
Contractor's Proposal	B1-B4
Non-Collusion Affidavit	B5
Bid Bond	B6
Agreement	C1-C3
Performance Bond	C4
Payment Bond	C5
General Conditions	1-21
Definitions	1
Standard Specifications	1
Director of Transportation	2
Site Inspection	3
Protection of Premises	4
Change Orders	5
Substitution of Equals	6
Final Inspection - Notice of Completion	7
Termination of Contracts	7
Payments and Monthly Estimates	8
Force Account Payment	9
Final Payment	10
Damages	10
Documents of Contractor	11
Responsibility of Contractor in Emergency	11
Labor Code	11
Obstructions	12
Insurance - Hold Harmless	12
Equal Employment Opportunity	15
Deposit of Securities	16
Assignment of Claims	17
Claims Resolution	17
Dust Abatement	18
AQMD Requirements	22-47
Special Provisions	48-119
Reference Drawings	



Table of Contents

SPECIAL PROVISIONS	48
DESCRIPTION:	48
SPECIFICATIONS:.....	48
REFERENCE SPECIFIC BRANDS OR PRODUCTS:.....	48
DISPOSAL OF EXCESS EXCAVATION OR MATERIALS:.....	48
RECORD DRAWINGS:.....	49
COOPERATION:	49
SURVEY STAKING:.....	49
LIQUIDATED DAMAGES:	50
ITEMS OF WORK:	51
ORDER OF WORK:.....	51
PROJECT APPEARANCE:.....	51
TRAFFIC CONTROL SYSTEM/ PUBLIC CONVENIENCE/ PUBLIC SAFETY:	51
MAINTAINING TRAFFIC:.....	53
GRAFFITI REMOVAL AND CLEANING:.....	54
DEVELOP WATER SUPPLY:	56
WATER POLLUTION CONTROL (SANTA MARGRITA WATERSHED):.....	56
STREET SWEEPING:.....	59
CLEARING AND GRUBBING:	61
REMOVE TRAFFIC STRIPES AND PAVEMENT MARKINGS:.....	61
REMOVE AND SALVAGE ROADSIDE SIGNS:	62
REMOVE AND RECONSTRUCT EXISTING FACILITIES:	63
MINOR CONCRETE CURB RAMP, CURB & GUTTER, DRIVEWAY :.....	63
AGGREGATE BASE:.....	64
HOT MIX ASPHALT:.....	65
MINOR CONCRETE STRUCTURES:.....	70
REINFORCED CONCRETE PIPE:	71
ROADSIDE SIGNS:.....	73
PAINT TRAFFIC STRIPE (2 COATS):.....	74
THERMOPLASTIC CROSSWALK AND PAVEMENT MARKING:.....	74
PAVEMENT MARKERS (REFLECTIVE):	75
FINISHING ROADWAY:.....	75
OBSTRUCTIONS:	75
<i>Adjustments to Grade for Obstructions</i>	77
SIGNAL AND LIGHTING	79
A. GENERAL.....	79
B. START OF WORK	79
C. COUNTY FURNISHED EQUIPMENT	79
D. EQUIPMENT ORDERS	80
E. EQUIPMENT LIST AND DRAWINGS	80



F. WARRANTIES, GUARANTIES, INSTRUCTION SHEETS, AND MANUALS	81
G. BLANK	81
H. FOUNDATIONS	81
I. STANDARDS, STEEL PEDESTALS AND POSTS	81
J. CONDUITS.....	82
K. PULL BOXES	83
L. CONDUCTORS AND WIRING	84
M. BONDING AND GROUNDING	84
N. SERVICE.....	84
O. TESTING.....	86
P. CONTROLLER ASSEMBLY.....	86
Q. VEHICLE SIGNAL ASSEMBLIES.....	89
R. PEDESTRIAN SIGNAL ASSEMBLIES	91
S. PEDESTRIAN, BICYCLE AND EQUESTRIAN PUSH BUTTONS	96
T. DETECTORS	97
U. LUMINARIES	103
V. SIGN LIGHTING FIXTURES	103
W. INTERNALLY ILLUMINATED STREET NAME SIGN	103
X. PHOTOELECTRIC CONTROLS	104
Y. EMERGENCY VEHICLE PREEMPTION SYSTEM.....	105
Z. GPS UNIVERSAL TIME SOURCES	109
AA. BATTERY BACKUP SYSTEM	109
BB. PAYMENT METHOD.	117
DE-MOBILIZATION:.....	118
POLYVINYL CHLORIDE (PVC) FENCE:.....	118



NOTICE INVITING BIDS

County of Riverside, herein called Owner, invites sealed proposals for:

**TRAFFIC SIGNAL AND LIGHTING PROJECT
AT THE INTERSECTION OF
MURRIETA HOT SPRINGS ROAD AND WILLOWS AVENUE**

PROJECT No. C2-0128

Proposal shall be delivered to the Riverside County Transportation Department, 14th Street Annex, 3525 14th Street, Riverside, California 92501, telephone (951) 955-6780 not later than 2:00 p.m., on Wednesday, June 27, 2012, to be promptly opened in public at said address. Each proposal shall be in accordance with plans, specifications, and other contract documents, dated April 2012, and prepared by County of Riverside, whose address is same as the above, from whom they may be obtained upon deposit of \$35 per set plus mailing. No refund. Prospective bidders may preview the plans, specifications and other contract documents, at no charge prior to purchase, at the above noted location.

The Contractor is required to have a Class "A" license or "C-10" license at the time of bid submission.

Dated: June 5, 2012

Kecia Harper-Ihem, Clerk of the Board

By: _____
Deputy



INSTRUCTIONS TO BIDDERS

1. Form of Proposal. The proposal must be made on the form of Contractor's Proposal which is included in the Contract Documents and must be completely filled in, dated and signed. If provision is made for alternates, they must all be bid, unless otherwise provided in the Special Provisions.
2. Bid Bond. The proposal must be accompanied by a 10% Bid Bond, using the form provided in the Contract Documents, or by a certified or cashier's check payable to the order of County in an amount not less than 10% of the amount bid, inclusive of alternates.
3. Submission of Proposal. A proposal must be submitted in a sealed opaque envelope which clearly identifies the bidder and the project. Bids must be received by the time and at the place set forth in the Notice Inviting Bids and may be withdrawn only as stated in the proposal. Bids shall be completed in ink.
4. Contract Documents. The complete Contract Documents are identified in the Agreement. Potential bidders are cautioned that the successful bidder incurs duties and obligations under all of the Contract Documents and that they should not merely examine the Plans and Specifications in making their bid.
5. License. To be considered for award of the contract, a potential bidder must have the kind of license required under provisions of the California Business and Professions Code for the work covered in this proposal. This includes joint ventures.

Each item of work will be performed by a Contractor which is qualified and properly licensed for that work.

Pursuant to California Labor Code Section 3099, certification is required for all persons who perform work as electricians for Contractors licensed as Class C-10 Electrical Contractors. Proof of certification shall be provided to the County before the start of construction.

6. Quantities. The amount of work to be done or materials to be furnished under the Contract as shown in the Contractor's Proposal are but estimates and are not to be taken as an expressed or an implied statement that the actual amount of work or materials will correspond to the estimate.

County reserves the right to increase or decrease or to entirely eliminate certain items from the work or materials to be furnished if such action is found to be desirable or expedient.

Contractor is cautioned against the unbalancing of his bid by prorating his overhead only into one or two items when there are a number of items listed in the schedule.

7. Interpretation of Documents. Discrepancies, omissions, ambiguities, requirements likely to cause disputes between trades and similar matter shall be promptly brought to the attention of the County of Riverside in writing. When appropriate, Addenda will be issued by County.

If the Bidder requires clarification or interpretation of the Bidding Documents, the Bidder shall make a written request to the County by a Request for Information (RFI). All requests for information must be submitted, in writing, between the hours of 8:00 AM and 5:00 PM on any day, Monday through Friday (except holidays), up to, including and no later than the fifth (5th) day prior to Bid Closing Deadline, by hand delivery, mail, fax or electronic mail. The County of Riverside will not respond to Requests for Information submitted after that time, unless the County determines, at its sole discretion, which it is in the best interest of the public and the County to do so. Requests for Information should be addressed to: County of Riverside, Transportation Department, Attn: Joel Jimenez; 3525 14th Street, Riverside, CA 92501, facsimile (951) 955-3164, electronic mail: jjjimenez@rctlma.org

No communication by anyone as to such matters except by an Addendum affects the meaning or requirements of the Contract Documents.

8. Addenda. County reserves the right to issue Addenda to the Contract Documents at any time prior to the time set to open bids. Each potential bidder shall leave with the County Transportation Department his name and address for the purpose of receiving Addenda to be mailed or delivered to such names at such addresses. To be considered, a Contractor's Proposal must list and take into account all issued Addenda.
9. Inspection of Site. Bidders must examine the site and acquaint themselves with all conditions affecting the work. By making his bid a bidder warrants that he has made such site examination as he deems necessary as to the condition of the site, its accessibility for materials, workmen and utilities and ability to protect existing surface and subsurface improvements. No claim for allowances - time or money - will be allowed as to such matters.
10. Bonds. The County requires a 100% Payment Bond and 100% Performance Bond from the successful bidder. All Bonds must be on County's forms contained in the Contract Documents.

The bonds must be underwritten by a Surety Company, which is admitted to transact the business of insurance in the State of California, and which carries a rating in the current issue of Best's Insurance Guide of "A" or better with a financial size of at least "VIII". The bond forms included in the project documents shall be used. All signatures on the bonds shall be notarized. Bonds shall be provided with an executed Power of Attorney issued by the surety.

11. Bids. Bids are required for the entire work, including all alternate bid schedules, if applicable, unless otherwise explicitly allowed in the bid documents. The amount of the bid for comparison purposes will be the total of all items. The total of unit basis items will be determined by extension of the item price bid on the basis of the estimated quantity set forth for the item.

The bidder shall set forth for each item of work in clearly legible figures, an item price and a total for the item in the respective spaces provided for this purpose. In the case of unit basis items, the amount set forth under the "Total" column shall be the extension of the item price bid on the basis of the estimated quantity for the item.

In case of discrepancy between the item price and the total set forth for the item, the item price shall prevail, provided, however, if the amount set forth as an item price is ambiguous, unintelligible or uncertain for any cause, or is omitted, or in the case of unit basis items, is the same amount as the entry in the "Total" column, then the amount set forth in the "Total" column for the item shall prevail in accordance with the following:

- a. As to lump sum items, the amount set forth in the "Total" column shall be the item price.
- b. As to unit basis items, the amount set forth in the "Total" column shall be divided by the estimated quantity for the item and the price thus obtained shall be the item price.

The bidder is advised that the items of work may be grouped into bid schedules, and that certain bid items may be listed in more than one bid schedule, and with different bid item numbers, and the following shall apply thereto:

The bidder is directed to submit the same bid amount for all contract bid items that are listed with the same item code and item description. Said bid items are referred to herein as "Like Bid Items".

"Like Bid Items" shall be considered a single bid item for purposes of calculating increased and decreased quantities, and as otherwise applicable in Section 4-1.03, "Changes" of the Standard Specifications.

The following are not subject to this bidding requirement:

1. Bid items with the same item code but different item descriptions.
2. Bid items that are measured as "lump sum" or "force account".
3. Alternate bid schedules.

In the event that a bidder submits different unit bid amounts for "Like Bid Items", as described above, the bid will be corrected by applying the lowest of the unit bid amounts to all the respective "Like Bid Items".

No bidder may withdraw his bid for a period of ninety (90) days after the bid opening.

12. Award of Contract. The County reserves the right to reject all bids received. Acceptance by the governing body of the County by resolution or minute order at a meeting regularly called

and held of a Contractor's Proposal constitutes an award of the contract and the execution of the Agreement is a written memorial thereof.

The County of Riverside will submit the contract documents to the low responsive and responsible bidder for execution prior to award utilizing the following procedures and requirements:

- a. A bidder whose proposal is accepted shall execute the formal construction agreement with the County of Riverside, similar to the form attached hereto as a sample, and shall return said agreement, together with approved performance and payment bonds and with complete evidence of insurance as required elsewhere herein, including executed additional insured endorsements and waivers of subrogation, within ten (10) working days from the date of the Notice of Acceptance of Proposal and Intent to Award as issued by the Transportation Department. All submittals shall meet the requirements of the bid documents. Corrections, if required, shall be made and the revised documents shall be resubmitted within two (2) working days of Contractor's receipt of review comments.
 - b. The contract bonds and insurance documentation shall be submitted in accordance with the contract requirements prior to submission to the County of Riverside Board of Supervisors for award by the Transportation Department, and prior to the performance of any work under the contract.
 - c. If a Bidder to whom a Notice of Acceptance of Proposal and Intent to Award has been issued, fails or refuses to sign a construction agreement, or to furnish the bonds or insurance certificates and endorsements as required within the prescribed period of time as described above, the County of Riverside may, at its sole discretion, rescind the Notice of Acceptance, and the bid guarantee submitted by that Contractor shall become the property of the County of Riverside as prescribed in the bid documents and as allowed by law.
 - d. If it is in the best interest of the County of Riverside, the County reserves the right to award the contract prior to execution by the Contractor. Thereafter, County shall mail or deliver to the lowest responsible bidder the agreement for Contractor's execution and return.
13. Return of Guarantee. Bid bonds will not be returned unless specifically requested by the bidder. Any submitted negotiable securities of unsuccessful bidders will be returned by mail within 30 days of the award of a contract to the successful bidder. Any submitted negotiable security of the successful bidder will be returned by mail within 30 days of receipt by the County of executed contract, certificate of insurance, performance bond and payment Bond.
14. Subletting and Subcontracting. Bidders are required pursuant to the Subletting and Subcontracting Fair Practices Act (commencing with Section 4100 of the Public Contracts Code) to list in their proposal the name and location of place of business of each subcontractor who will perform work or labor or render services in or about the construction

of the work or improvement or a subcontractor who specifically fabricates and installs a portion of the work or improvement according to detailed drawings contained in the Plans and Specifications in excess of 1/2 of 1% of this prime Contractor's total bid. Failure to list a subcontractor for a portion of the work means that the prime Contractor will do that portion of the work. It is the County's intent for the Subletting and Subcontracting Fair Practice Act to apply to all phases of the work.

15. Qualifications of Bidders. No award will be made to any bidder who cannot give satisfactory assurance to the Board of Supervisors as to his own ability to carry out the contract, both from his financial standing and by reason of his previous experience as a Contractor on work of the nature contemplated in the contract. The bidder may be required to submit his record of work of similar nature to that proposed under these specifications, and unfamiliarity with the type of work may be sufficient cause for rejection of bid.
16. Contract Participation. Riverside County's M/W/DVBE Contract Participation Program affirms the utilization and participation of qualified minority, women and disabled veteran firms in its contracting and procurement activities. The County encourages general and prime Contractors to afford competitive subcontracting opportunities to minority, women and disabled veteran firms where possible, in their contracting and procurement activities with the County of Riverside.
17. Hours of Work. Attention is directed to Section 8-1.06, "Time of Completion" and Section 7-1.01A (1), "Hours of Labor" of the Standard Specifications.

Daily working hours shall be between the hours of 7:00 a.m. and 6:00 p.m., Monday through Friday, except legal holidays, as approved by the Engineer. Exceptions and specific work schedules shall be submitted to the Engineer for consideration.

18. Labor Code. Pursuant to the Labor Code, the governing board of the Owner has obtained from the Director of the Department of Industrial Relations, State of California, his determinations of general prevailing rates of per diem wages applicable to the work, and for holiday, and overtime work, including employer payments for health and welfare, pensions, vacation and similar purpose, as set forth on schedule which is on file at the principal office of the Owner, and which will be made available to any interested person upon request.
19. Alternate Bid Schedules. If the Proposal includes bid items listed under a Base Bid Schedule and one or more Alternate Bid Schedules, the following shall apply: The County may award only the items of work listed on the Base Bid Schedule, or may choose to award some or all of the Alternate Bid Schedules in addition to the Base Bid Schedule. Unless otherwise specified, the basis of the selection of the lowest bid shall be the lowest responsive and responsible bid for the sum of all Bid Schedules.

If the Proposal includes bid items listed under two or more Alternate Bid Schedules with no Base Bid Schedule, the following shall apply: This project contains Alternate Bid Schedules that may or may not be mutually exclusive, as described elsewhere in the bid documents. The County may award the items of work listed on one or more of the Alternate Bid

Schedules. In the case of mutually exclusive Alternate Bid Schedules, only one of the Alternate Bid Schedules will be selected for award. Unless otherwise specified, the basis of the selection of the lowest bid shall be the lowest responsive and responsible bid for the sum of all Bid Schedules.

The County also reserves the right to reject all bids received.

20. Dust Abatement. Attention is directed to Section 23, "Dust Abatement" with regard to the dust abatement provisions of the contract.
21. Submission of Insurance Certificate. Within ten (10) working days of the date of the Notice of Acceptance of Proposal and Intent to Award issued by the County of Riverside, the successful Contractor shall submit a certificate of insurance, including required endorsements, which provides evidence that the bidding Contractor has insurance coverage that meets the requirements of Section 18 of the General Conditions. Failure to have complete insurance coverage in place and to provide all required certificates and endorsements within the specified ten (10) working days period will be grounds for declaring the bidder to not be in compliance with the bid documents, rescinding the Notice of Acceptance, making a claim against the bid bond, and awarding to the second low bidder, at the sole discretion of the County.

CONTRACTOR'S PROPOSAL

TO: COUNTY OF RIVERSIDE

DATE: _____

hereafter called "County":

BIDDER: _____
(hereafter called "Contractor")

THE UNDERSIGNED, Contractor, having carefully examined the site and the Contract Documents for the construction of Traffic Signal and Lighting Project at the intersection of Murrieta Hot Springs Road and Willows Avenue, Project No. C2-0128, hereby proposes to construct the work in accordance with the Contract Documents, including Addenda Nos. _____ for the amount stated in this Proposal.

By submitting this Proposal, Contractor agrees with County:

1. That unless withdrawn in person by Contractor or some person authorized in writing by Contractor not by telephone or telegram before the time specified in the Notice Inviting Bids for the public opening of bids, this Proposal constitutes an irrevocable offer for 90 calendar days after that date.
2. County has the right to reject any or all Proposals and to waive any irregularities or informalities contained in a Proposal.
3. To execute the Agreement and deliver the Faithful Performance Bond, Payment Bond and Insurance Certificate with endorsements, which comply with the requirements set forth in the Instructions to Bidders and General Conditions, within ten (10) working days of the date of the Notice of Acceptance of Proposal and Intent to Award as issued by the County of Riverside.
4. That the contract shall be awarded upon a resolution or minute order to that effect duly adopted by the governing body of County; and that execution of the Contract Documents shall constitute a written memorial thereof.
5. To submit to County such information as County may require to determine whether a particular Proposal is the lowest responsible bid submitted.

6. That the accompanying certified or cashier's check or Bid Bond is in an amount not less than 10% of the total bid submitted and constitutes a guarantee that if awarded the contract, Contractor will execute the Agreement and deliver the required bonds within ten (10) days after notice of award. If Contractor fails to execute and deliver said documents, the check or bond is to be charged with the costs of the resultant damages to County, including but not limited to publication costs, the difference in money between the amount bid and the amount in excess of the bid which it costs County to do or cause to be done the work involved, lease and rental costs, additional salaries and overhead, increased interest and costs of funding the project, attorney expense, additional engineering and architectural expense and cost of maintaining or constructing alternate facilities occasioned by the failure to execute and deliver said documents.
7. By signing this proposal the Contractor certifies that the representations made therein are made under penalty of perjury.

**TRAFFIC SIGNAL AND LIGHTING PROJECT
AT THE INTERSECTION OF
MURRIETA HOT SPRINGS AND WILLOWS AVENUE**

PROJECT NO. C2-0128

PROPOSAL

ITEM No.	ITEM CODE	ITEM	UNIT	ESTIMATED QUANTITY	ITEM PRICE (IN FIGURES)	TOTAL (IN FIGURES)
1	066102	DUST ABATEMENT	LS	1		
2	074020	WATER POLLUTION CONTROL	LS	1		
3	120100	TRAFFIC CONTROL SYSTEM	LS	1		
4	160101	CLEARING AND GRUBBING	LS	1		
5	860201	SIGNAL AND LIGHTING	LS	1		
6	650014	18" REINFORCED CONCRETE PIPE	LF	12		
7	017104A	JUNCTION STRUCTURE - RCFC STD NO.2, STD DRAWING No. JS 227	EA	1		
8	000003	CONCRETE BULKHEAD - RCFC STD M816	EA	1		
9	000003	24" x 24" CATCH BASIN WITH STEEL PARKWAY GRATE	EA	1		
10	000003	GRIND AND REPLACE PAVEMENT FOR 1' WIDE SLOT PATCH	LS	1		
11	017315	MINOR CONCRETE (CURB RAMP) (CRS 403 - CASE A)	EA	4		
12	017304	MINOR CONCRETE (CURB AND GUTTER) (CRS 200)	LF	40		
13	017310	MINOR CONCRETE (DRIVEWAY APPROACH) (CRS 207)	EA	1		
14	000003	REMOVE EXISTING MEDIAN AND PAVEMENT, AND RECONSTRUCT PER DETAIL "C" AND "D"	EA	2		
15	018001	FENCE	LF	56		
16	150717	REMOVE TRAFFIC STRIPE AND PAVEMENT MARKING	SQFT	350		
17	840656	PAINT TRAFFIC STRIPE (2-COAT)	LF	3,200		
18	840519	THERMOPLASTIC CROSSWALK AND PAVEMENT MARKING	SQFT	1,000		
19	566011	ROADSIDE SIGN - ONE POST	EA	19		
20	000003	REMOVE AND SALVAGE ROADSIDE SIGN	EA	8		
21	850102	PAVEMENT MARKER (REFLECTIVE)	EA	130		
22	019901	DE-MOBILIZATION	LS	1	11,000.00	11,000.00

PROJECT TOTAL: _____ \$ _____

ITEMS 1-22 "WORDS"

BIDDER DATA:

Name of Bidder _____

Type of Organization _____

Person(s) Authorized to Sign for Bidder _____

Address _____

_____ Phone _____

Contractor's License _____
Type & Number

Expiration Date _____

8. **DESIGNATION OF SUBCONTRACTORS:** Contractor submits the following complete list of each subcontractor who will perform work or labor or render service in or about the construction in an amount in excess of 1/2 of 1% of the total bid.

<u>ITEM</u>	<u>SUBCONTRACTOR</u>	<u>ADDRESS</u>	<u>LICENSE NO.</u>
-------------	----------------------	----------------	--------------------

Percent of work to be performed by sub-contractors: _____%
(Note: 50% of the work required to be performed by general contractor)

IN WITNESS WHEREOF Contractor executed this Proposal as of the date set forth on Page 1 of this proposal.

TITLE _____

"Contractor"

Non-Collusion Declaration

To be executed by bidder and submitted with bid. (Public Contract Code Section 7106)

The undersigned declares:

I am the _____ (Title) of _____ (Company),
the party making the foregoing bid.

The bid is not made in the interest of, or on behalf of, any undisclosed person, partnership, company, association, organization, or corporation. The bid is genuine and not collusive or sham. The bidder has not directly or indirectly induced or solicited any other bidder to put in a false or sham bid. The bidder has not directly or indirectly colluded, conspired, connived, or agreed with any bidder or anyone else to put in a sham bid, or that anyone shall refrain from bidding. The bidder has not in any manner, directly or indirectly, sought by agreement, communication, or conference with anyone to fix the bid price of the bidder or any other bidder, or to fix any overhead, profit, or cost element of the bid price, or of that of any other bidder.

All statements contained in the bid are true. The bidder has not, directly or indirectly, submitted his or her bid price of any breakdown thereof, or the contents thereof, or divulged information or data relative thereto, to any corporation, partnership, company, association, organization, bid depository, or to any member or agent thereof to effectuate a collusive or sham bid, and has not paid, and will not pay, any person or entity for such purpose.

Any person executing this declaration on behalf of a bidder that is a corporation, partnership, joint venture, limited liability company, limited liability partnership, or any other entity, hereby represents that he or she has full power to execute, and does execute, this declaration on behalf of the bidder.

I declare under penalty of perjury under the laws of the State of California that the foregoing is true and correct and that this declaration is executed on

_____ (Month) _____ (Day) of _____ (Year),

at _____ (City), California.

Signature of Declarant: _____

Printed name of Declarant: _____

Name of Bidder (Company): _____

Title or Office: _____

Note: Notarization of signature required.
 Check box if attachment is included.

Bid Bond

Recitals:

1. _____ "Contractor", has submitted his/her Contractor's Proposal to County of Riverside, "County", for the construction of public work for **Traffic Signal and Lighting Project at the intersection of Murrieta Hot Springs Road and Willows Avenue, Project No. C2-0128** in accordance with a Notice Inviting Bids from the County.
2. _____ a _____ corporation, hereafter called "Surety", is the surety of this bond.

Agreement:

We, Contractor as Principal and Surety as Surety, jointly and severally agree and state as follows:

1. The amount of the obligation of this bond is 10% of the amount of the Contractor's Proposal, including bid alternates, and inures to the benefit of County.
2. This Bond is exonerated by (1) County rejecting said Proposal or, in the alternate, (2) if said Proposal is accepted, Contractor executes the Agreement and furnishes the Bonds as agreed to in its Proposal, otherwise it remains in full force and effect for the recovery of loss, damage and expense of County resulting from failure of Contractor to act as agreed to in its Proposal. Some types of possible loss, damage and expense are specified in the Contractor's Proposal.
3. Surety, for value received, stipulates and agrees that its obligations hereunder shall in no way be impaired or affected by any extension of time within which County may accept the Proposal and waives notice of any such extension.
4. This Bond is binding on our heirs, executors, administrators, successors and assigns.

Dated: _____

Signatures:

By: _____

By: _____

Title: Attorney in Fact
"Surety"

Title: _____
"Contractor"

STATE OF _____
COUNTY OF _____

} ss. SURETY'S ACKNOWLEDGEMENT

On _____ before me, _____ personally appeared, _____ known to me, or proved to me on the basis of satisfactory evidence, to be the person whose name is subscribed to the within instrument and acknowledged to me that he/she executed the same in his/her authorized capacities, and that by his/her signature on the instrument the person, or the entity upon behalf of which the person acted, executed the instrument.

WITNESS my hand and official seal.

Signature of Notary Public

Notary Public (Seal)

Note: This Bond must be executed by both Contractor and Surety with corporate seal affixed. All signatures must be notarized. (Attach acknowledgements).

AGREEMENT

THIS AGREEMENT is entered into at Riverside, California as of the date set forth below is between County of Riverside hereafter called "County" and _____ hereafter called "Contractor".

WITNESSETH

RECITALS:

1. Contractor has submitted to County his Contractor's Proposal for the construction of County Project, _____ in strict accordance with the Contract Documents identified below and County has accepted said Proposal.
2. Contractor states that he has reexamined his Contractor's Proposal and found it to be correct, has ascertained that his subcontractors are properly licensed and possess the requisite skill and forces, has reexamined the site and Contract Documents and is of the opinion that he can presently do the work in accordance with the Contract Documents for the money set forth in his Proposal to be paid as provided in the Contract Documents.

AGREEMENT:

IT IS AGREED BY THE PARTIES AS FOLLOWS:

1. Contract Documents. The entire contract consists of the following: (a) The Agreement. (b) The Notice Inviting Bids. (c) The Instruction to Bidders. (d) The Contractor's Proposal. (e) The Bid Bond. (f) The Payment Bond. (g) The Performance Bond. (h) The General Conditions. (i) The Special Provisions. (j) The Standard Specifications of the State of California Department of Transportation edition of May 2006 as modified in other portions of the Contract Documents. (k) The Standard Plans of the Department of Transportation identified on the plans or in the Special Provisions. (l) The Plans. (m) Addenda No. _____. (n) The Determination of Prevailing Wage Rates for Public Work. (o) Any Change Orders issued. (p) Any additional or supplemental specifications, notice, instructions and drawings issued in accordance with the provisions of the Contract Documents. All of said Documents presently in existence are by this reference incorporated herein with like effect as if here set forth in full and upon the proper issuance of other documents they shall likewise be deemed incorporated. The Bid Bond is exonerated upon execution of this Agreement and the Payment Bond and Faithful Performance Bond.
2. The Work. Contractor shall do all things necessary to construct the work generally described in Recital No. 1 in accordance with the Contract Documents.

3. Liquidated Damages and Time of Completion. Attention is directed to the provisions in Section 8-1.06, "Time of Completion", and in Section 8-1.07, "Liquidated Damages", of the Standard Specifications and these Special Provisions.

The Contractor shall begin work within 15 days of the date stated within the written "Notice to Proceed".

The Contractor shall notify the Engineer, in writing, of his intent to begin work at least 72 hours before work is begun. The notice shall be delivered to the Transportation Department's Construction Engineer and shall specify the date the Contractor intends to start. If the project has more than one location of work, a separate notice shall be given for each location.

Should the Contractor begin work in advance of receiving a written "Notice to Proceed", any work performed by him in advance of the date stated in the "Notice to Proceed" shall be considered as having been done by him at his own risk and as a volunteer and subject to the following:

- (1) The Contractor shall, on commencing operations, take all precautions required for public safety and shall observe all the provisions in the Specifications and the Special Provisions.
 - (2) All work done according to the contract prior to the issuance of the "Notice to Proceed", will be considered authorized work and will be paid for as provided in the contract.
 - (3) The Contractor shall not be entitled to any additional compensation or an extension of time for any delay, hindrance or interference caused by or attributable to commencement of work prior to the issuance of the "Notice to Proceed".
4. Compensation. Contractor shall be paid in the manner set forth in the Contract Documents the amount of his Proposal as accepted by County, the above rates, subject to additions and deductions as provided in the Contract Documents. Said Proposal is on file in the Office of the Clerk of the Board of Supervisors of County.

IN WITNESS WHEREOF the parties hereto have executed this agreement as of the date set forth below.

COUNTY OF RIVERSIDE

CONTRACTOR

BY _____
Chairman, Board of Supervisors

BY _____

Dated _____

TITLE: _____
(If Corporation, Affix Seal)

ATTEST:

ATTEST:

Kecia Harper-Ihem, Clerk of the Board

BY _____
Deputy

TITLE: _____

Licensed in accordance with an act providing for the registration of Contractors,

License No. _____

Federal Employer Identification Number:

"County"
(Seal)

"Corporation"
(Seal)

PERFORMANCE BOND

Recitals:

1. _____ (Contractor) intend to enter into an Agreement with COUNTY OF RIVERSIDE (County) for construction of public work known as _____.
2. _____, a _____ corporation (Surety), is the Surety under this Bond.

Agreement:

We, Contractor, as Principal, and Surety, as Surety, jointly and severally agree, state, and are bound unto County, as obligee, as follows:

1. The amount of the obligation of this Bond is 100% of the estimated contract price for the Project of \$ _____ and inures to the benefit of County.
2. This Bond is exonerated by Contractor doing all things to be kept and performed by it in strict conformance with the Contract Documents for the Project, otherwise it remains in full force and effect for the recovery of loss, damage and expense of County resulting from failure of Contractor to so act. All of said Contract Documents are incorporated herein.
3. This obligation is binding on our successors and assigns.
4. For value received, Surety stipulates and agrees that no change, time extension, prepayment to Contractor, alteration or addition to the terms and requirements of the Contract Documents or the work to be performed thereunder shall affect its obligations hereunder and waives notice as to such matters, except the total contract price cannot be increased by more than 10% without approval of Surety.

THIS BOND is executed as of _____.

By _____

By _____

By _____

Type Name _____

Its Attorney in Fact
"Surety"

Title _____

"Contractor"

(Corporate Seal)

(Corporate Seal)

NOTE: This Bond must be executed by both parties with corporate seal affixed. All signatures must be acknowledged. (Attach acknowledgements).

PAYMENT BOND

(Public Work - Civil Code 3247 et seq.)

The makers of this Bond are _____, as Principal and Original Contractor and _____, a corporation, authorized to issue Surety Bonds in California, as Surety, and this Bond is issued in conjunction with that certain public works contract to be executed between Principal and COUNTY OF RIVERSIDE a public entity, as Owner, for \$ _____, the total amount payable. THE AMOUNT OF THIS BOND IS ONE HUNDRED PERCENT OF SAID SUM. Said contract is for public work generally consisting of _____.

The beneficiaries of this Bond are as is stated in 3248 of the Civil Code and requirements and conditions of this Bond are as is set forth in 3248, 3249, 3250 and 3252 of said code. Without notice, Surety consents to extension of time for performance, change in requirements, amount of compensation, or prepayment under said contract.

DATED: _____

Original Contractor - Principal

Surety

By _____

By _____
Its Attorney In Fact

Title _____
(If corporation, affix seal)

(Corporate Seal)

STATE OF CALIFORNIA }
COUNTY OF _____ } ss. SURETY'S ACKNOWLEDGEMENT

On _____ before me, _____ personally appeared, _____, known to me, or proved to me on the basis of satisfactory evidence, to be the person whose name is subscribed to the within instrument and acknowledged to me that he/she executed the same in his/her authorized capacities, and that by his/her signature on the instrument the person, or the entity upon behalf of which the person acted, executed the instrument.

WITNESS my hand and official seal.

Signature of Notary Public

Notary Public (Seal)

Note: This Bond must be executed by both parties with corporate seal affixed. All signatures must be notarized

GENERAL CONDITIONS

SS 1. DEFINITIONS:

- a. "County", "Contractor", and "Contract Documents" are identified in the Agreement. "County" and "Contractor" includes their authorized representatives are treated throughout as if each were singular in number. "Contractor" includes its surety.
- b. "Engineer" and "Director of Transportation" means the Director of Transportation for the County of Riverside, and includes his authorized representatives.
- c. "Plans" means the portion of the Contract Documents consisting of all drawings prepared for the direction and characteristics of the work. A schedule of said drawings which constitutes the plans as of the execution of the Agreement is set forth in the Special Provisions and are supplemented by the Standard Plans referred to in the Special Provisions.
- d. "State of California", "Department of Transportation" and "Director of Transportation", means the County of Riverside.

SS 2. STANDARD SPECIFICATIONS:

The Standard Specifications of the State of California Department of Transportation, edition of May 2006 hereafter called "Standard Specifications", are incorporated herein as modified in these General Conditions, the Special Provisions and the Plans.

The following subsections of the Standard Specifications are deleted:

1-1.13, 1-1.15, 1-1.18, 1-1.25, 1-1.37, 1-1.40, 2-1.01, 2-1.05, 2-1.07, 5-1.14, 7-1.165, 8-1.03, 9-1.05, 9-1.065, 9-1.10, 12-2.02.

Section 3 of the Standard Specifications is deleted.

The following deletions and additions are made from the following subsections of the Standard Specifications.

Subsection 5-1.04, add to the second paragraph at its end the following sentence: "The General Conditions govern over

all of the Contract Documents except the Special Provisions, the Agreement and Bonds."

Subsection 7-1.01A (2), strike the last sentence of the second paragraph and in its place read: "These wage rates are on file in the Office of the County Clerk and are a part of the Contract."

Subsection 7-1.15, for "Director" read "Director of Transportation" except for last reference read "County of Riverside".

Subsection 7-1.16, delete references to Subsection 7-1.165.

Subsection 8-1.06, strike the last paragraph.

Subsection 8-1.08, strike "as provided in the State Contract Act".

SS 3. DIRECTOR OF TRANSPORTATION:

All work shall be done under the supervision of the Director of Transportation who shall determine the amount, quality, acceptability and fitness of all parts of the work, and interpret the Contract Documents. No act or omission of the Director of Transportation relieves Contractor of the duty to proceed with the work in strict conformity with the Contract Documents.

Upon request, Director of Transportation shall reduce to writing any oral order, objection, requirement or determination. Whenever Director of Transportation's approval is required it shall be in writing only.

All communications to County by Contractor shall be via Director of Transportation.

No work shall be performed on site other than during normal working hours without the knowledge and consent of Director of Transportation.

When in Director of Transportation's opinion, weather or other conditions are such that attempts to perform a portion of the work will probably result in work not in accordance with the Contract Documents, he shall so advise Contractor. When Contractor advises Director of Transportation that he intends to proceed despite such advise, he does so at his peril. The Director of Transportation may then order Contractor, in writing which specifies the portion of the work involved and the conditions warranting the issuance of the order, not to proceed on such portion of the work if (1) proceeding will in his judgment have an adverse effect on Contractor's

ability to complete the work within the stipulated time period, or (2) proceeding will in his judgment necessitate unusual tests and procedures to ascertain whether said portion of the work is in accordance with the Contract Documents. Contractor shall comply with such orders at its expense.

Nothing herein contained relieves Contractor from the duty to make independent determinations as to weather and other conditions affecting the proper completion of the work.

Failure for any reason of Director of Transportation to advise Contractor as to such matters, or to issue an order as above provided, does not relieve Contractor from the duty to accomplish the work in accordance with the Contract Documents.

As stated elsewhere, amounts shown in the Proposal and Agreement as to quantities are but estimates only. From time to time Director of Transportation shall direct Contractor as to the prosecution of the work in such a manner as to increase or decrease such estimates as to the work actually to be done. Contractor shall comply with such instructions and shall be paid only for work actually done based on the unit price set out in the Agreement.

SS 4. SITE INSPECTION - EFFECT OF OTHER IMPROVEMENTS SHOWN AND CONTRACTOR PROCEDURE:

Elsewhere in the Contract Documents reference may be made, graphically, descriptively or both, to the existence or possible existence of other improvements affecting the site and the prosecution of the work such as surface and subsurface utilities, drainage ditches and courses, buildings, fencing, retaining walls, roadways, curbs, trees, shrubs, and similar matters. Such matters are included to be used by Contractor to the extent he deems appropriate. However, it is expressly understood and agreed:

- a. Showing or describing such items does not mean that it is an exhaustive and complete presentation and that as to matters shown or described that they necessarily exist.
- b. All graphic presentations are schematic only unless the contrary is clearly set out elsewhere as to a particular matter.
- c. Whenever in the plans survey markers are shown, boundaries of the site are shown or contour lines are shown, Contractor may assume that such matters are shown in accordance with acceptable standards.

All improvements of the nature above described, whether elsewhere shown or described or not, shall, unless the contrary is elsewhere specifically directed, remain in place, undisturbed and suitably protected during the course of the work.

Whenever during the course of the work a subsurface improvement is discovered which Contractor believes is unknown to County, he shall immediately so inform Director of Transportation. Except as elsewhere provided, whenever in the course of the work it becomes apparent that the work cannot proceed without the destruction or relocation of any improvement, whether shown or described or not, Contractor shall immediately cease work affecting such improvements and notify Director of Transportation as to such circumstance and await instructions as to how to proceed.

- d. The Contractor shall be required to cooperate fully with all utility forces or forces of other public agencies engaged in relocation, lowering, altering or otherwise rearranging any facilities interfering with the progress of work or installing any facilities thereon.

The Contractor will also be required to cooperate fully with any County or State forces working on or near the project, or requiring access to the work in the performance of their duties.

SS 5. USE OF AND PROTECTION OF PREMISES AND REMOVAL OF DEBRIS:

At his expense Contractor shall:

- a. Take every precaution against injuries to persons or damage to property.
- b. Comply with regulations governing the use of the property.
- c. Store and suitably protect his apparatus, equipment, materials and supplies in an orderly fashion on site.
- d. Place on the work only such loads as are consistent with the safety of the work.
- e. Effect all cutting, fitting, or patching of his work required to make it conform to the Plans and Specifications and interrelate with other improvements or except with the consent of Director of

Transportation, cut or otherwise alter existing improvements.

- f. Protect and preserve established bench marks and monuments, make no changes in the location of such without the prior written approval of County, replace and relocate any of them which may be lost or destroyed or which require shifting because of necessary changes in grades or locations. All replacement and relocation work shall be accomplished only after approval of County and under the direct supervision and instruction of Director of Transportation.
- g. Before final payment remove all surplus materials, false work, temporary structures, debris, and similar matter resulting from his operations from the site and to put the site in an orderly condition.
- h. Construct, operate and maintain all passageways, guard fences, lights, barricades and other facilities required for protection by State or municipal laws and regulations and local conditions during the course of the work.
- i. Guard County's property from injury or loss.
- j. Take all reasonable precautions for dust and noise control and generally conduct operations so as not to constitute a nuisance.
- k. The Contractor shall be responsible for the protection of existing signs, fences, concrete curb and gutter and other highway facilities which may be encountered in the roadway. The replacement or repair of any facilities which the County deems necessary as a result of the Contractor's operations shall be done by the Contractor at his own expense and to the satisfaction of the County Transportation Department.

SS 6. CHANGE ORDERS - DETAIL DRAWINGS AND INSTRUCTIONS:

Reference is made to 4-1.03 and 4-1.03A of the Standard Specifications regarding change orders. Wherever in these subsections the word "Engineer" appears read "County".

Each approved change order shall be considered as an amendment to the Contract Documents and will not be considered approved until executed by the Board of Supervisors, except Director of Transportation can approve certain change orders without the necessity of approval by

the Board as provided in a Resolution of the Board adopted March 30, 1993, Resolution Number 93-047.

The above does not limit the ability of Director of Transportation to issue further detail drawings, explanations and instructions which are customarily given by an Engineer during the course of similar work. Director of Transportation will furnish Contractor with reasonable promptness such further detailed explanations, instructions and drawings as may be necessary for the proper execution of the work, and Contractor shall conform to same provided they are consistent with the intent of the Contract Documents. In giving such additional instructions, explanations and drawings Director of Transportation has authority to make minor changes in the work which do not involve extra cost and are not inconsistent with the Contract Documents.

Contractor's acting on such instructions, explanations and drawings of Director of Transportation means that Contractor agrees that such explanations, instructions and drawings are within the scope of the work in accordance with the intent of the Contract Documents and do not constitute a basis for modification of the Contract Documents as to price or time.

SS 7. BRAND OR TRADE NAME - SUBSTITUTE OF EQUALS:

Reference is made to Section 3400 of the Public Contracts Code, which is by this reference incorporated herein with like effect as if here set forth in full.

If a potential bidder believes he knows of an equal to a specified brand or trade name which is not mentioned in the Contract Documents, then such potential bidder may so advise Director of Transportation of such fact, giving all relevant information. If appropriate, an addendum will be issued as to the alleged equal provided that such issuance may be accomplished at least 5 days before the time fixed for opening bids.

Unless the subject article or product is expressly designated for matching others in use in a particular public improvement either completed or in the course of completion, any bidder may, as part of its bid proposal, include a request for substitution of an item equal to any specified by brand or trade name.

Within 35 calendar days after award of the contract, Contractor may submit to Director of Transportation data substantiating such a request, and the difference, if any, in cost. Director of Transportation shall promptly investigate the request and make a recommendation to County as to equality. The governing body of County shall promptly determine whether the substitute is equal in every respect

to the item specified, and approve or deny the request accordingly, and shall notify Director of Transportation of the determination made, who shall advise Contractor in writing of the decision. Unless the request is granted, substitution will not be permitted.

Nothing herein shall authorize a change in the contract price or prevent the use of change orders in the manner provided elsewhere in the Contract Documents.

SS 8. FINAL INSPECTION - NOTICE OF COMPLETION:

When the work is ready for final inspection County shall cause the work to be inspected and subjected to such tests as seem to it to be required for the purpose of determining if the work is complete in every respect.

At a meeting of the governing body of County held within 10 days after final inspection, the governing body shall consider the facts developed at the inspection. If it is found that the work is apparently complete in every respect, County will accept the work and a notice of completion will be recorded.

As between the parties, the recordation of the Notice of Completion, unless recorded because of a cessation of labor, means only that the time for final payment and the commencement of the guarantee period commences to run.

SS 9. COUNTY'S RIGHT TO STOP WORK OR TERMINATE THE CONTRACT:

(1) Contractor shall be adjudged bankrupt or make an assignment for the benefit of creditors, or (2) a receiver or liquidator is appointed for Contractor or any of his property, or (3) Contractor shall refuse or fail after Notice of Warning from County by Director of Transportation to supply sufficient properly skilled workmen or suitable materials, or (4) Contractor fails to prosecute the work with such diligence as will insure its completion within the stipulated time period, or (5) Contractor shall fail to make payments to persons supplying labor or materials for the work, or (6) Contractor does not comply with applicable law or instructions of Director of Transportation, or (7) Contractor is otherwise guilty of a substantial violation of any provision of the Contract Documents, then County without prejudice to such other and further right, remedy or relief it may be entitled to, may by 10 days notice to Contractor, terminate the employment of Contractor and his right to proceed, either as to the entire work, or at County's option, as to any portion thereof as to which delay shall have occurred or breach or noncompliance relates, and may thereupon take possession of the affected work and complete

the work by contract or otherwise, as County deems expedient. In such case Contractor shall not be entitled to receive any further payment until the work is finished. If the unpaid balance shall exceed the expense of completion, and other damage, expense or loss of County occasioned by Contractor's failure to properly perform, such excess shall be paid by Contractor. If such expense and damage exceeds the unpaid balance, Contractor is liable to County for the excess. If County elects to proceed under this Section, it may take possession of and utilize in completing the work such materials, supplies, plant and equipment on site which may be necessary or convenient for the purpose of completing the work, County is expressly granted the right - acting via Director of Transportation, an Engineer or otherwise - to operate equipment and machinery on site for the purpose of determining whether it has a basis for proceeding under this section.

If the construction of the project herein is damaged, which damage is determined to have been proximately caused by an act of God, in excess of 5% of the contract amount, provided that the work damaged is built in accordance with applicable building standards and the plans and specifications, then the Owner, upon certification by the Engineer, may, without prejudice to any other right of remedy, terminate the contract.

Decision by County not to proceed under this Section does not constitute a waiver by County of any right it might from time to time have against Contractor under the Contract Documents.

SS 10. PAYMENT AND MONTHLY ESTIMATES:

Director of Transportation, once each month, after said work is commenced and until after the completion and acceptance thereof, shall make and deliver to Contractor duplicate certificates stating the value of work then completed according to the contract, estimated according to the standard of the unit contract price, and thereupon Contractor shall be paid an amount sufficient with all previous payments to make the aggregate ninety five percent (95%) of the amount earned as certified. Maximum value of progress payment retention, as set forth in Section 9-1.06 of the Standard Specifications and any other referenced text, shall be five (5%).

The partial payments made as the work progresses will be payment on account on work performed as of the 25th of the month and shall in no way be considered as an acceptance of any part of the work or material of the contract, nor shall they in any way govern the final estimate. No such estimate or payment shall be made when in the judgement of the

Director of Transportation the total value of the work done since the last estimate amounts to less than \$300.

For the purpose of timely payment, the "receipt of payment request" date, as described in Public Contract Code 20104.50 and as referred to herein, shall be considered to be the fifth working day following the 25th day of each month.

Within 5 working days of the 25th day of each month the County shall:

- a. Calculate and prepare the certificate ("progress pay estimate") stating the value of the work completed for the billing month, for the purpose of determining the proper progress payment amount.
- b. If a progress pay estimate has been prepared by the County but has been contested by the Contractor as of the "receipt of payment request" date, as defined above, the County shall submit to the Contractor a document setting forth in writing a description of the dispute pertaining to the progress billing, and the County's reason for it's position. Said document shall be submitted to the Contractor as soon as practicable, but not later than 7 calendar days after the "receipt of payment request" date.

Any progress pay estimate which is undisputed and remains unpaid for thirty (30) calendar days, after the "receipt of payment request date" shall accrue interest to the Contractor equivalent to the legal rate set forth in subdivision (a) of Section 685.010 of the California Code of Civil Procedure. The number of days available to the County to make a payment without incurring interest pursuant to this section shall be reduced by the number of days by which the County exceeds the seven-day submittal requirement set forth in the paragraph above.

Pursuant to Public Contract Code Section 20104.50, subsection (e), the progress payment date is the date that funds are encumbered and the payment warrant is issued.

SS 11. PAYMENT FOR EXTRA WORK (FORCE ACCOUNT BASIS):

Extra work to be paid for on a force account basis as directed by the Engineer will be paid for as set forth in Section 9-1.03 of the Standard Specifications. The labor surcharge, equipment rental rates and the right of way delay factors for each classification of equipment are listed in the Department of Transportation publication entitled Labor Surcharge and Equipment Rental Rates. A copy of which is on file at the Office of the Director of Transportation and is hereby incorporated herein in its entirety.

SS 12. FINAL PAYMENT:

Within thirty (30) days after the completion of the work and its acceptance by the Board of Supervisors, Director of Transportation will make a proposed final estimate in writing of the quantities of work done under the contract and the value of such work and will submit such estimate to Contractor. Within thirty (30) days thereafter Contractor shall submit to Director of Transportation his written approval of said proposed final estimate or a written statement of all claims which he has for additional compensation claimed to be due under the contract.

On Contractor's approval or if he files no claims within said period of thirty (30) days, Director of Transportation will issue a final written estimate as submitted to Contractor and County shall pay the entire sum so found to be due after deducting there from all previous payments and all amounts to be kept and all amounts to be retained under the provisions of the contract.

If Contractor within said period of thirty (30) days files claims, Director of Transportation will issue as a semi-final estimate the proposed estimate submitted to Contractor and the County will within thirty (30) days pay the sum found due thereon after deducting all prior payments and all amounts to be kept and retained under the provisions of the contract, Director of Transportation shall then consider and investigate Contractor's claims and shall make such revisions in the said estimate as he may find to be due, and shall then make and issue his final written estimate. County will pay the amount so found due after deducting all previous payments and amount to be retained under the contract.

All prior or partial estimates and payments shall be subjected to correction in the final estimate and payment.

The final estimate shall be conclusive and binding against both parties to the contract on all questions relating to the performance of the contract and the amount of work done there under and compensation therefore, except in the case of gross error. Acceptance of final payment constitutes a release of County by Contractor of all claims relating to the work.

SS 13. DAMAGES:

Contractor acknowledges that failure to perform in strict accordance with the Contract Documents will cause County to suffer special damages in addition to cost of completion of the work in accordance with the provisions of the Contract

Documents. Such special damage could include, but is not limited to, lease and rental cost, additional salaries and overhead, interest during construction, attorney expense, additional engineering, and inspection expense and cost of maintaining or constructing alternate facilities.

SS 14. DOCUMENTS OF CONTRACTOR:

Upon demand, Contractor shall make available to County all documents in its possession relevant to the work accomplished or to be accomplished or any demand or claim of Contractor as to County. This includes copies of documents sent by Contractor or others in its possession. Contractor shall further make available to County conformed copies of all documents submitted to the sureties who executed the Bid Bond, Faithful Performance Bond or Payment Bond for the purpose of obtaining the sureties' signature, including any guarantee or indemnification made to such surety by others for such purpose. Contractor shall maintain in his possession all documents relative to the work for three years after Notice of Completion.

SS 15. RESPONSIBILITY OF CONTRACTOR TO ACT IN AN EMERGENCY:

In case of an emergency which threatens loss or injury to property or life, Contractor shall act without previous instructions as the situation may warrant. Contractor shall notify Director of Transportation immediately thereafter. Any compensation claimed by Contractor, together with substantiating documentation shall be submitted to County via Director of Transportation.

SS 16. LABOR CODE:

Reference is made to Chapter 1, Part 7, Division 2 of the California Labor Code (commencing with Section 1720). By this reference said Chapter 1 is incorporated herein with like effect as if it were here set forth in full. The parties recognize that said Chapter 1 deals, among other things with discrimination, penalties and forfeitures, their disposition and enforcement, wages, working hours, and securing worker's compensation insurance and directly effect the method of prosecution of the work by Contractor and subject it under certain conditions to penalties and forfeitures. Execution of the Agreement by the parties constitutes their agreement to abide by said Chapter 1, their stipulation as to all matters which they are required to stipulate as to by the provisions of said Chapter 1, constitutes Contractor's certification that he is aware of the provisions of said Chapter 1 and will comply with them and further constitutes Contractor's certification as

follows: "I am aware of the provisions of Section 3700 of the California Labor Code which require every employer to be insured against liability for worker's compensation or to undertake self-insurance in accordance with the provisions of that Code, and I will comply with such provisions before commencing the performance of the work of this contract." Contractor and his subcontractors shall comply with the provisions of SS 1777.5 of the Labor Code regarding apprentices.

Contractor shall post at each job site during the course of the work a copy of County's "Determination of Prevailing Wage Rates", copies of said Determination are available from County for this purpose.

SS 17. OBSTRUCTIONS:

Attention is directed to Sections 8-1.10, "Utility and Non-Highway Facilities" and 15, "Existing Highway Facilities" of the Standard Specifications and these Special Provisions.

Add the following to the fourth paragraph of Section 8-1.10, "Utility and Non-Highway Facilities", of the Standard Specifications is amended to read:

In the event that the utility facilities mentioned above are not removed or relocated by the times specified and, if in the opinion of the Engineer, the Contractor's operations are delayed or interfered with by reason of the utility facilities not being removed or relocated by said times, the State will compensate the Contractor for such delays to the extent provided in Section 8-1.09, "Right of Way Delays" of the Standard Specifications, and not otherwise, except as provided in Section 8-1.10, "Utility and Non-Highway Facilities" of the Standard Specifications.

SS 18. INSURANCE - HOLD HARMLESS:

In lieu of the provisions of Section 7-1.12 the following shall apply:

Contractor shall not commence work under this contract until he has obtained the insurance required hereunder and satisfactory proof of said insurance has been submitted to and approved by the County of Riverside.

Contractor shall submit to the County of Riverside a Certificate of Insurance, signed by an authorized representative of the Contractor's insurance provider or agency, which certifies to the County that insurance

coverage is provided in accordance with the requirements of this section. The Certificate of Insurance shall include as attachments the required "Waiver of Subrogation" and "Additional Insured" policy endorsements.

I. Workers Compensation Insurance:

Contractor shall procure and maintain during the life of the contract Worker's Compensation Insurance coverage as prescribed by the laws of the State of California. Policy shall include Employers' Liability including Occupational Disease with limits not less than \$1,000,000 per occurrence. Policy shall be endorsed to provide a Borrowed Servant Endorsement, Alternate Employer Endorsement, or Additional Insured Endorsement naming the County of Riverside, its Director's Officers, Special Districts, Board of Supervisors, employees, agents or representatives as Additional Insureds. Policy shall contain a Waiver of Subrogation in favor of the County of Riverside.

Contractor shall further require each of its subcontractors to procure Worker's Compensation Insurance as required by the State while working on the project and the Contractor shall require the subcontractors to endorse the policy to provide a Borrowed Servant Endorsement, Alternate Employer Endorsement, or Additional Insured Endorsement naming the County of Riverside, its Director's Officers, Special Districts, Board of Supervisors, employees, agents or representatives as Additional Insureds. Policy shall contain a Wavier of Subrogation in favor of the County of Riverside.

II. Comprehensive General Liability Insurance:

Contractor shall take out and maintain during the course of the work General Liability Insurance covering bodily injury and property damage insurance and blanket contractual coverage as to the work and obligations covered hereunder. The amount of the insurance shall be in an amount **not less than \$2,000,000**. The policy may be a combined single limit or split limits, but the amount must be no less than \$2,000,000 per occurrence. The insurance carrier must have a current rating of "A" or better by the A.M. Best Company, a financial size of at least "VIII", and be an admitted carrier in the State of California. Any exceptions must be approved in advance by the County of Riverside Risk Management. Said insurance must contain an endorsement the County of Riverside is named as an additional insured as respects the work covered hereunder and **said insurance must not**

contain, as respects the work covered hereunder, any exclusions as to bodily injury or death or property damage arising out of blasting, explosion, or underground damage to wire, pipes, conduits, mains, sewers, tank tunnels or any similar property - i.e. the so-called "x c u" exclusions. The insurance certificate evidencing such insurance must affirmatively state that the insurance carrier (s) will give Owner 30 days written notice prior to cancellation of the insurance or a reduction in coverage, and that "County of Riverside - its Director's Officers, Special Districts, Board of Supervisors, employees, agents and representatives" are named as Additional Insureds.

In the alternate to naming County of Riverside as additional insured, Contractor may take out and maintain during the course of the work and until acceptance by County, Owner's Protective Liability Insurance in an amount not less than \$2,000,000 covering Riverside County.

III. Auto Liability:

If Lessee's vehicles or licensed mobile equipment will be on the premises or used in any manner on behalf of the County, then Lessee shall maintain auto liability insurance for all owned, non-owned or hired automobiles in an amount not less than \$1,000,000 per occurrence combined single limit. Policy shall name the "County of Riverside, its Director's Officers, Special Districts, Board of Supervisors, employees, agents, or representatives" as Additional Insureds.

IV. Hold Harmless:

Contractor shall hold County of Riverside its officers, agent, and employees free and harmless from any liability whatsoever, including wrongful death, based or asserted upon any act or omission of Contractor, its officers, agents, employees or subcontractors relating to or in anywise connected with or arising from the accomplishment of the work, whether or not such acts or omissions were in furtherance of the work required by the Contract Documents and agrees to defend at his expense, including attorney fees, Owner, County of Riverside its officers, agents and employees in any legal action based upon any such alleged acts or omissions.

SS 19. EQUAL EMPLOYMENT OPPORTUNITY:

General:

Contractor shall not discriminate in its recruiting, hiring, promotion, demotion or termination practices on the basis of race, religious creed, color, national origin, ancestry, sex, age or physical handicap in the performance of this Contract shall comply with the provisions of the California Fair Employment Practice Act (commencing with SS 1410 of the Labor Code), the Federal Civil Rights Act of 1964 (P.L. 88-352) and all amendments thereto, Executive Order No. 11246 (30 Federal Register 12319), as amended, and all administrative rules and regulations issued pursuant to said Acts and Order. See particularly 41 Code of Federal Regulation (CFR) Chapter 60.

Contractor shall require each of its subcontractors to comply with the preceding paragraph and shall include in each subcontract language similar to the preceding paragraph.

Contractor shall permit access to its records of employment, employment advertisement, application forms and other pertinent data and records by Owner and any State or Federal agency having jurisdiction for the purpose of investigation to ascertain compliance with this Section.

Owner may assign an affirmative action representative to monitor Contractor and its subcontractor (s) conduct required by this Section, including the right of entry to the construction site for the purpose of obtaining information from persons performing work on the project providing such inspection does not interfere with the progress of the work.

Elsewhere in the Contract Documents specific requirements may be contained covering the same subject matter of this Section. If so, such specific requirements prevail over this Section in case of conflict.

Transactions of \$10,000 or Under:

Contracts and subcontracts not exceeding \$10,000 are exempt from the requirements of this Section. No Contractor or subcontractor shall procure supplies and/or services in less than usual quantities to avoid applicability of this Section. With respect to contracts and subcontractors for indefinite quantities, this Section applies unless the amount required in any one year under such contract will reasonably be expected not to exceed \$10,000.

Transactions in Excess of \$10,000, but Less Than \$50,000:

At Owner's request, Contractor shall certify that it has in effect an affirmative action plan and agrees to comply with all State and Federal laws and regulations regarding Fair Employment Practices. Contractor shall maintain a written copy of its affirmative action plan and furnish Owner a copy of the plan upon request. Owner may require Contractor to complete an Affirmative Action Compliance Report, on a form furnished by Owner, setting forth definite goals during the term of the Contract.

Transactions of \$50,000 or More:

If Contractor has fifty or more employees and a Contract for \$50,000 or more, it shall develop and submit to Owner, within thirty days after award, a written affirmative action compliance program providing in detail specific steps to guarantee equal employment opportunity. Contractor shall include in its affirmative action program a table of job classifications, which table shall include but need not be limited to job titles, duties, and rates of pay.

Contractor shall in each subcontract let to do a portion of the work covered hereunder, where the subcontractor involved has fifty or more employees and the subcontract is for \$50,000 or more, impose in the subcontract the above requirements.

For the purpose of determining the number of employees, the average of the Contractor's or its subcontractor's employees for the twelve-month period immediately prior to award, or the total number of employees the Contractor or its subcontractor will have when performing this contract, whichever is higher, shall be used.

Federal Assisted Construction:

If this project is a Federally assisted construction project, then the contract provisions contained in 41 CFR SS 60-1.04 (b) are incorporated herein and the Contractor shall likewise incorporate said provisions in each subcontract entered by Contractor to perform the work. Federally assisted construction is identified as such in the Notice Inviting Bids.

SS 20. DEPOSIT OF SECURITIES:

In accordance with Public Contract Code Section 22300 and other applicable law, the Contractor may substitute securities for any moneys withheld to ensure performance under the contract.

SS 21. ASSIGNMENT OF CLAIMS:

In submitting a bid on this public works project, or any subcontractor agreeing to supply goods, services, or materials, and entering a contract pursuant thereto, the Contractor and/or subcontractor do offer and agree to assign to the Owner all rights, title, and interest in and to all causes of action it may have under Section 4 of the Clayton Act (15 U.S.C. Section 15) or under the Cartwright Act (Chapter 2 (commencing with Section 16700) of Part 2 of Division 7 of the Business and Professions Code), arising from purchases of goods, services, or materials pursuant to the public works contract or the subcontract. This assignment shall be made and become effective at the time the awarding body tenders final payment to the Contractor, without further acknowledgement by the parties.

SS 22. CLAIMS RESOLUTION:

In accordance with Public Contract Code Section 20104 - 20104.8 and other applicable law, public works claims of \$375,000 or less which arise between the Contractor and the Owner shall be resolved following the statutory procedure unless the Owner has elected to resolve the dispute pursuant to Public Contract Code SS 10240 et seq.

1. All claims shall be submitted in writing and accompanied by substantiating documentation. Claims must be filed on or before the date of final payment unless other notice requirements are provided in the contract. "Claim" means a separate demand by the claimant for (1) a time extension, (2) payment of money or damages arising from work done by or on behalf of the claimant and payment of which is not otherwise expressly provided for or the claimant is not otherwise entitled, or (3) an amount the payment of which is disputed by the Owner.

(a) Claims Under or equal to \$50,000. The Owner shall respond in writing to the claim within 45 days of receipt of the claim, or, the Owner may request, in writing, within 30 days of receipt of the claim, any additional documentation supporting the claim or relating to defenses or claims the Owner may have. If additional information is needed thereafter, it shall be provided upon mutual agreement of the Owner and the claimant. The Owner's written response shall be submitted 15 days after receiving the additional documentation, or within the same period of time taken by the

claimant to produce the additional information, whichever is greater.

(b) Claims over \$50,000 but less than or equal to \$375,000. The Owner shall respond in writing within 60 days of receipt, or, may request in writing within 30 days of receipt of the claim, any additional documents supporting the claim or relating to defenses or claims the Owner may have against the claimant. If additional information is needed thereafter, it shall be provided pursuant to mutual agreement between the Owner and the claimant. The Owner's response shall be submitted within 30 days after receipt of the further documents, or within the same period of time taken by the claimant to produce the additional information or documents, whichever is greater.

2. If the claimant disputes the Owner's response, or if the Owner fails to respond within the statutory time period, the claimant may so notify the Owner within 15 days of the receipt of the response or the failure to respond, and demand an informal conference to meet and confer for settlement. Upon such demand, the Owner shall schedule a meet and confer conference within 30 days.
3. If following the meet and confer conference, the claim or any portion thereof remains in dispute, the claimant may file a claim pursuant to Government Code SS 900 et seq. and Government Code SS 910 et seq. For purposes of those provisions, the time within which a claim must be filed shall be tolled from the time the claimant submits the written claim until the time the claim is denied, including any time utilized for the meet and confer conference.
4. If a civil action is filed to resolve any claim, the provisions of Public Contract Code SS 20104.4 shall be followed, providing for non-binding mediation and judicial arbitration.

SS 23. DUST ABATEMENT:

Dust control shall conform to Section 10, "Dust Control", Section 7-1.01F, "Air Pollution Control", Section 17, "Watering", and Section 18, "Dust Palliative" of the Standard Specifications, Rules no. 401, 402, 403 and 403.1 of the South Coast Air Quality Management District (AQMD), Riverside County Code, Chapter 8.52, "Fugitive Dust Reduction Program For Coachella Valley", all other applicable Federal and State laws, and the requirements set forth herein.

The Contractor is cautioned that failure to control fugitive dust may result in fines being levied by the South Coast Air Quality Management District to both the Contractor and the County of Riverside, as owner. The Contractor shall be fully responsible for payment of all fines pertaining to air pollution control violations, resulting from Contractor's operations related to the construction contract, which may be levied against both the Contractor and the County of Riverside by the AQMD or other regulatory agencies. The Contractor's attention is directed to Section 7-1.01, "Laws to be Observed" of the Standard Specifications. The cost of all fines levied against the County of Riverside will be deducted from any moneys due or which may become due to the Contractor, unless other payment arrangements are made by the Contractor.

Dust control of all of the Contractor's operations is required 24 hours per day, 7 days a week for the duration of the contract, and until the disturbed soil is permanently stabilized. The Contractor shall take every precaution to prevent emissions of fugitive dust from the project site, from locations of stockpiled materials, from unpaved driving surfaces, from haul vehicles, from inactive construction areas, and from all other operations of the Contractor. The Contractor shall plan for and carry out proper and efficient measures to prevent his operations from producing dust in amounts damaging to property or which constitute a public nuisance, or which cause harm to persons living or working in the vicinity of the work. Of particular concern are emissions of PM10 particles, which are fine particulate matter of 10 microns or less and which are associated with sickness and death from respiratory disease.

The Contractor shall furnish and post dust mitigation signs, which shall be, at a minimum, in accordance with the "AQMD Signage Recommendations", attached hereto. Additional copies are available upon request from the Engineer. The sign shall include the Contractor's phone number which shall be maintained on a 24 hour basis. The sign message, size and design, including any deviations from the signage recommendations, shall be approved by the Engineer prior to fabrication.

The Contractor shall respond to complaints by mobilizing equipment and personnel at the construction site within 2 hours of each complaint to control fugitive dust.

Attention is directed to AQMD Rule 403.1, which applies to all contracts within the Coachella Valley Area of Riverside County. That AQMD Rule requires the Contractor to take specified dust control actions when prevailing wind speeds exceed 25 miles per hour. Wind forecasts, AQMD Rules and

other related information are provided by AQMD at 1-800-CUT-SMOG and at www.aqmd.gov.

Any days on which the Contractor is prevented from working, due to the requirements of AQMD Rules, will be considered as non-working days, in accordance with Section 8-1.06, "Time of Completion" of the Standard Specifications.

The Contractor shall utilize the "Best Available Control Measures" of controlling fugitive dust, as prepared by the AQMD. For projects within the Coachella Valley, the "Reasonably Available Control Measures" may be employed, if effective within the context of the AQMD rules. However, if fugitive dust crosses the project boundary, more effective control measures, including the "Best Available Control Measures" shall be implemented.

A site-specific fugitive dust control plan shall be submitted to the Engineer for review and approval at least 10 days prior to the start of construction. Additionally, for projects outside of the Coachella Valley which meet the criteria for AQMD plan approval, the Contractor shall submit the dust control plan to AQMD for approval. AQMD plan submittal criteria is defined in AQMD Rule 403 as being for projects that will have disturbed surface area in excess of 100 acres, or for projects with a scope of work which requires the movement of more than 10,000 cubic yards of soil on each of any three working days.

A sample plan and other pertinent information is attached, and additional copies are available from the Engineer upon request. The fugitive dust control plan shall include the "Reasonably Available Control Measures" and "Best Available Control Measures" of controlling fugitive dust, as may be appropriate and necessary, including but not limited to watering, application of chemical dust suppressants, wind fencing, covering of haul vehicles, haul vehicle bed-liners, covering or chemically stabilizing stored materials, phased grading, planting of vegetation, the use of a 24 hour environmental observer, and track-out controls at locations where unpaved construction accesses intersect with paved roads. The use of chemical stabilizers, which are approved by all environmental regulatory agencies, and the use of reclaimed water is encouraged. If water is intended as a primary dust control tool, the dust control plan shall provide for at least one 2,000 gallon water truck for every 4 acres of disturbed soil, unless otherwise approved by the Engineer.

If the Construction Engineer determines that the project scope and the forecasted weather conditions are such that the Contractor's work is unlikely to be a source of dust emissions, the Construction Engineer has the authority to waive the requirements for submittal of a dust control plan

and for placement of the dust control signs described herein. However, the Contractors responsibilities for the control of fugitive dust and the other requirements of this section may not be waived.

A completion notice will not be filed, and the final payment will not be made to the Contractor until the areas of disturbed soil on the construction site, including roadway shoulders, are suitably stabilized for long term control of fugitive dust.

The successful Contractor shall attend an AQMD PM10 Dust Control Program training session, and furnish evidence of attendance to the Engineer. Attendance at AQMD training seminars can be scheduled through AQMD at 1-866-861-DUST (1-866-861-3878) or by email to dustcontrol@aqmd.gov. Current AQMD certification of previous attendance will be accepted.

At that training session, the successful Contractor will be furnished with the AQMD prepared Rule 403 and Rule 403.1 implementation handbooks, which include the "Best Available Control Measures" and "Reasonably Available Control Measures", and other associated information, including a listing of suggested dust control related devices, materials and chemicals.

The signature of the Contractor on the Proposal constitutes acknowledgement by the Contractor of the dust control requirements established by law and described herein, and the enforceability of those requirements.

When the contract includes a bid item for Dust Abatement, full compensation for conformance with these dust abatement requirements, including labor, equipment, materials, developing water supply and incidentals, shall be paid at the lump sum price for Dust Abatement, and no additional compensation will be allowed therefor.

When the contract does not include a bid item for Dust Abatement, full compensation for conformance with these dust abatement requirements, including labor, equipment, materials, developing water supply and incidentals, shall be considered as included in the various items of work, and no additional compensation will be allowed therefor.

AQMD RECOMMENDATIONS

November, 2001

Plan holder shall post signage at specified locations on the subject property in accordance with the standards specified below. The exception to the standards is that all letters shall be 4 inches high, with the names and telephone numbers of appropriate contacts and services in bold print, as indicated in the standards. These signs shall also include the SCAQMD toll free complaint line 1-800-CUT-SMOG (1-800-288-7664) and the telephone number for the Environmental Observer. These signs shall be posted within 50 feet of the curb on all four (4) corners of the subject property.

For each Dust Control Plan aggregating less than, or equal to, ten (10) acres:

1. The applicant shall install a sign on such property which is visible to the public that meets the following requirements:
 - (a) Such sign shall measure at least four (4) feet wide by four (4) feet high and conform to the specifications in 1 (a) below.

For each Dust Control Plan aggregating over ten (10) acres:

2. The applicant shall install a sign on such property which is visible to the public that meets the following requirements:
 - (a) Such sign shall measure at least eight (8) feet wide by four (4) feet high and conform to the specifications in 1 (b) below.

THE SIGN SHALL CONFORM TO THE FOLLOWING REQUIREMENTS:

1. The sign boards shall be constructed with materials capable of withstanding the environment in which they are placed.

(a) For 4' x 4' signs, the District recommends the following:

- I. 3/4" A/C laminated plywood board
- II. Two 4" x 4" posts
- III. The posts should be attached to the edges of the plywood board with at least 2 carriage bolts on each post.
- IV. The front surface of the sign board should be painted in the contrasting color of a white background with black lettering.

(b) For 4' x 8' signs, the District recommends the following:

- I. 1" A/C laminated plywood board
- II. Two 5" x 6" posts
- III. The posts should be attached to the 4' edges of the plywood board with at least 2 carriage bolts on each post.
- IV. The front surface of the sign board should be painted in the contrasting color of a white background with black lettering.

2. The sign board shall be installed and maintained in a condition such that members of the public can easily view, access, and read the sign at all times until the expiration date of the Dust Control plan.

(a) For 4' x 4' signs, the District recommends the following:

- I. The lower edge of the sign board should be mounted at least 2' above the existing ground surface to facilitate ease of viewing.
- II. The posts should be set in a hole at least 3' deep with concrete footings to preclude downing by high winds.
- III. On the construction site, the sign should be positioned such that nothing obstructs the public's view from the primary street access point.
- IV. For construction projects that are developed in phases, the sign should be moved to the area that is under active construction.
- V. In situations where all phases of the construction project are completed on a property prior to expiration of the Dust Control Plan, a written request for cancellation of the Dust Control Plan must be submitted to the Engineer.

(b) For 4' x 8' signs, the District recommends the following:

- I. The lower edge of the sign board should be mounted at least 2' above the existing ground surface to facilitate ease of viewing.
- II. The posts should be set in a hole at least 4' deep with concrete footings to preclude downing by high winds.
- III. On the construction site, the sign should be positioned such that nothing obstructs the public's view from the primary street access point.
- IV. For construction projects that are developed in phases, the sign should be moved to the area that is under active construction.
- V. In situations where all phases of the construction project are completed on a property prior to expiration of the Dust Control Plan, a written request for cancellation of the Dust Control Plan must be submitted to the Engineer.

3. The sign board shall contain the following information:

- (a) Project Name
- (b) Name of Prime Contractor
- (c) Phone Number of Contractor's Employee Responsible for Dust Control Matters
- (d) County designated phone number (to be provided by the Engineer)
- (e) South Coast Air Quality Management District Phone Number

4. The sign board shall be designed to the following alpha and numeric text dimensions (sign boards written in longhand are unacceptable).

(a) For a permittee subject to the 4' x 4' sign requirement, the District provides the following example: (as modified by the County of Riverside for use on County Public Works projects)

1" UPPERCASE Letters	PROJECT NAME:		3 ½" Title Case Bold Letters
1" UPPERCASE Letters	CONTRACTOR		3 ½" Title Case Bold Letters
1" Title Case Letters	Contractor's Dust Control Phone #		3" Bold Numbers
1" Title Case Letters	County of Riverside Phone #		3" Bold Numbers
1" Title Case Letters	Phone Number:	SCAQMD 1-800-CUT-SMOG	3 ½" Bold Numbers

"Title Case" means the first letter of a word is capitalized and subsequent letters are lower case.

(b) For a permittee subject to the 4' x 8' sign requirement, the District provides the following example: (as modified by the County of Riverside)

2" UPPERCASE Letters	PROJECT NAME:		4" Title Case Bold Letters
2" UPPERCASE Letters	CONTRACTOR		4" Title Case Bold Letters
2" Title Case Letters	Contractor's Dust Control Phone #		4" Bold Numbers
2" Title Case Letters	County of Riverside Phone #	909-	4" Bold Numbers
2" Title Case Letters	Phone Number:	SCAQMD 1-800-CUT-SMOG	4 1/2" Bold Numbers
2" Title Case Letters	COUNTY OF RIVERSIDE TRANSPORTATION DEPARTMENT		

Section 1

Simplified Sample Site Plan

Existing Residential

Distance and location of nearest:
 Residence _____
 Business _____

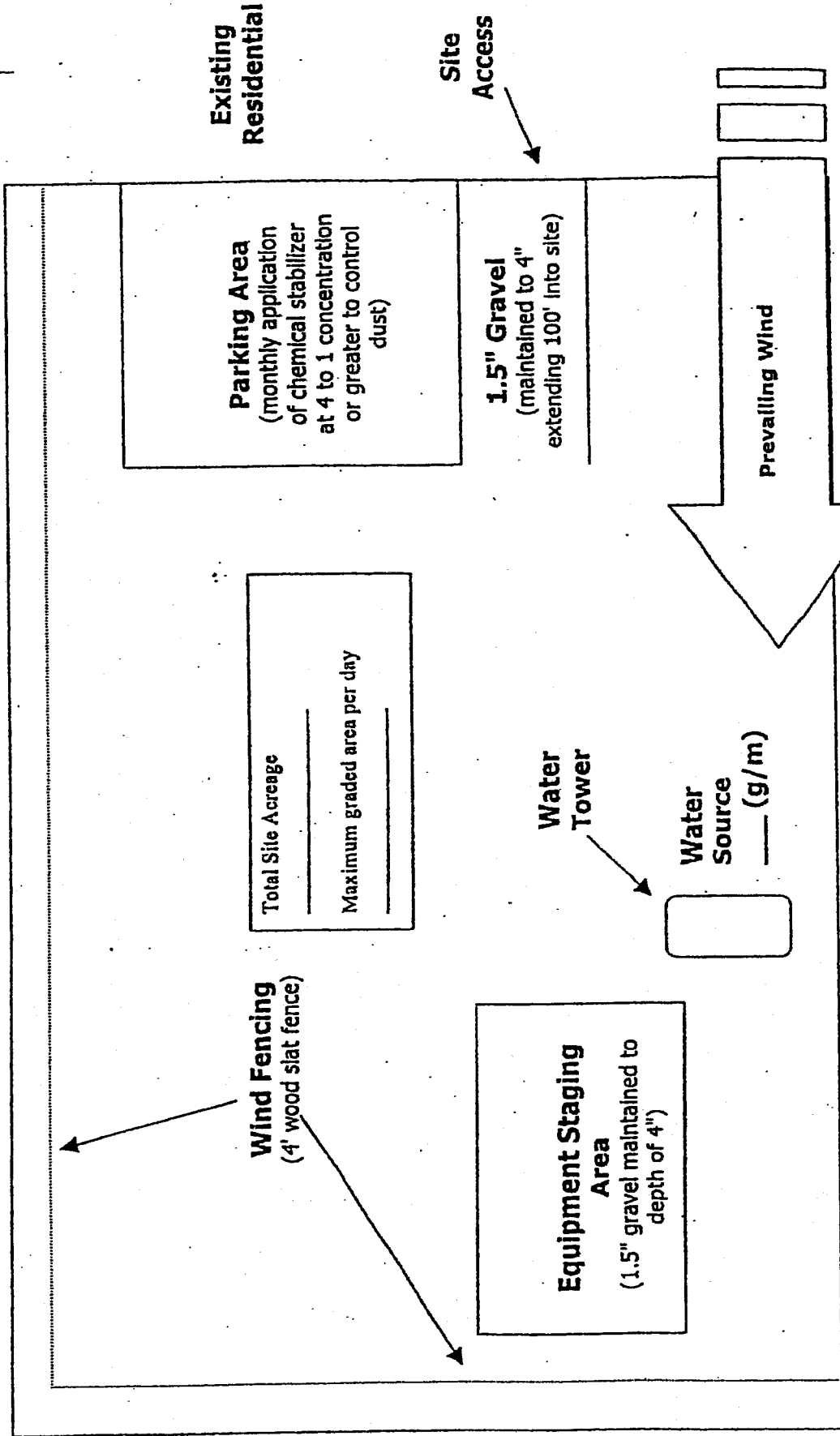
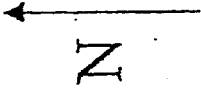

Remember...
**DUST CONTROL IS REQUIRED 24 HOURS A DAY, 7 DAYS A WEEK,
 REGARDLESS OF CONSTRUCTION STATUS**

Plan Review Checklist Clearing/Grubbing/Mass Grading Phase

If feasible, use grading permit conditions to break the project into phases so that only a portion of the site is disturbed at any given time to ensure control of fugitive dust. This technique is critical for project sites with greater than 100 acres.

Prior to initiating activity, pre-water site through use of portable irrigation lines. At least 72 hours of pre-watering is recommended for each area prior to initiating earth-movement. Require the Applicant to specify water source and available flow rate (g/m).

Water applied continuously to all disturbed portions of the site by means of water truck/water pull as necessary to maintain sufficient visible moisture on the soil surface. For reference, one 2,000 gallon water truck can treat approximately 4 acres of active construction per hour. Also, for cut and fill activities, one 10,000 gallon water pull is estimated to be necessary for each 7,000 cubic yards of daily earth-movement. Multiple 4,000-gallon water trucks may be used in place of one 10,000-gallon water pull. Touch and visual contrast are reasonably good indicators of soil moisture. Surface areas that are dry to the touch and appear lighter-colored require the application of additional water to prevent visible or fugitive dust. Require the Applicant to specify the number of watering vehicles available for dust control during mass grading and during off-hours as well as availability of back-up water trucks if the site experiences dust control problems.

Water towers are necessary for projects with more than 10 acres of active construction. Without a water tower, it can take up to 30 minutes to fill a 2,000 gallon water truck. Also, multiple water towers are necessary for projects that use water pulls as filling one 10,000 gallon water pull can drain a water tower which takes up to 40 minutes to refill.

Wind fencing is necessary between the site and nearby residences or businesses. Off-site upwind fencing and on-site wind fencing for larger projects can also keep blowsand from being deposited onto the site or traveling through the site.

A perimeter watering system consisting of portable irrigation equipment may be an effective mitigation system to protect surrounding residences and businesses. The portable watering system may be used in place of or in conjunction with watering trucks. The local jurisdiction may also be provided access to this equipment.

Remember...

**DUST CONTROL IS REQUIRED 24 HOURS A DAY, 7 DAYS A WEEK,
REGARDLESS OF CONSTRUCTION STATUS**

- Construction site accesses are to be improved with 1.5" gravel maintained to a depth of 4" , at least 20' wide, and extending 100 feet into the site. If the project site is not balanced, a wheel washing system and/or ribbed steel plates should be placed in the roadway before the vehicle enters the graveled area to clean the tires and prevent trackout.
- Equipment staging areas are to be treated with 1.5" gravel maintained to a depth of 4".
- Employee parking areas are to be covered with 1.5" gravel maintained to a depth of 4" or treated with chemical dust suppressants at a 4 to 1 ratio on at least a monthly basis to prevent fugitive dust.
- Chemical dust suppressants are to be mixed at a ratio of 20 to 1 and applied to all disturbed surfaces that are proposed to remain inactive for a period of at least 10 consecutive days. These products are effective in preventing and controlling dust. Recordkeeping is necessary to demonstrate compliance.
- All project sites greater than 100 acres shall monitor daily wind speeds and AQMD forecasted wind events (call 1.800.CUT.SMOG, press one for air quality information, and then press five for Coachella Valley wind forecasts). Operators shall maintain these records for review by any local code enforcement officer or AQMD inspector.
- An environmental observer whose primary duty is to oversee dust control at the site is to be used for construction projects greater than 100 acres and/or sites with more than 50 acres of active construction. The environmental observer is tasked with monitoring dust abatement measures and authorized to deploy additional water trucks and other dust control actions (i.e., wind fencing, street sweepers, chemical dust suppressants, etc.) as necessary to prevent or control fugitive dust.
- Other (specify): _____

Remember...
DUST CONTROL IS REQUIRED 24 HOURS A DAY, 7 DAYS A WEEK,
REGARDLESS OF CONSTRUCTION STATUS

Plan Review Checklist Finish Grading Phase

- Water applied continuously to all disturbed portions of the site by means of water truck/water pull as necessary to maintain sufficient visible moisture on the soil surface. For reference, one 2,000 gallon water truck can treat approximately 4 acres of active construction per hour. Also, for cut and fill activities, one 10,000 gallon water pull is estimated to be necessary for each 7,000 cubic yards of daily earth-movement. Multiple 4,000-gallon water trucks may be used in place of a 10,000-gallon water pull. Touch and visual contrast are reasonably good indicators of soil moisture. Surface areas that are dry to the touch and appear lighter-colored require the application of additional water to prevent visible or fugitive dust. Require the Applicant to specify the number of watering vehicles available for dust control during finish grading and during off-hours as well as availability of back-up water trucks if the site experiences dust control problems.

- Water towers are necessary for projects with more than 10 acres of active construction. Without a water tower, it can take up to 30 minutes to fill a 2,000 gallon water truck. Also, multiple water towers are necessary for projects that use water pulls as filling one 10,000 gallon water pull can drain a water tower which takes up to 40 minutes to refill.

- Wind fencing is necessary between the site and nearby residences or businesses to reduce fugitive dust. Off-site upwind fencing and on-site wind fencing for larger projects can also keep blowsand from being deposited onto the site or traveling through a site.

- Chemical dust suppressants are to be applied at a concentration of at least 10 to 1 to finish graded areas once final elevations have been reached. For areas that will remain inactive for longer periods, vegetation can be a cost-effective alternative to chemical stabilization. Wind fencing or other obstructions can keep the stabilized area free from future disturbances.

- Construction site access(es) are to be improved with 1.5" gravel maintained to a depth of at least 4" with a minimum width of at least 20', extending 100 feet into the project site.

- Equipment staging areas are to be treated with 1.5" gravel maintained to a depth of 4".

- Internal roadway networks are to be treated with chemical dust suppressants at a minimum rate of at least 4 to 1 and retreated on a monthly basis once final roadway elevations have been reached.

- Employee parking areas are to be treated with chemical dust suppressants at a mix ratio of at least 4 to 1 and retreated on at least a monthly basis or covered with 1.5" gravel maintained to a depth of 4" to prevent fugitive dust.

- Other (specify): _____

Remember...
DUST CONTROL IS REQUIRED 24 HOURS A DAY, 7 DAYS A WEEK,
REGARDLESS OF CONSTRUCTION STATUS

Plan Review Checklist Construction Phase

- Water applied continuously to all disturbed portions of the site by means of water truck/water pull is necessary to maintain sufficient visible moisture on the soil surface. For reference, one 2,000 gallon water truck can treat approximately 4 acres of active construction per hour. Touch and visual contrast are reasonably good indicators of soil moisture. Surface areas that are dry to the touch and appear lighter-colored require the application of additional water to prevent visible or fugitive dust. Require the Applicant to specify the number of watering vehicles available for dust control during the construction phase and during off-hours as well as availability of back-up water trucks if the site experiences dust control problems.

- Wind fencing is necessary between the site and nearby residences or businesses. Off-site upwind fencing and on-site wind fencing for larger projects can also keep blowsand from being deposited onto the site or traveling through the site. Block walls, if part of the final project, can replace wind fencing during the construction phase.

- Chemical dust suppressants are to be applied at a concentration of at least 20 to 1 to finish graded areas once final elevations have been reached. For areas that will remain inactive for longer periods, vegetation can be a cost-effective alternative to chemical stabilization. Wind fencing or other obstructions can keep the stabilized area free from future disturbances.

- Construction site accesses are to be improved with 1.5" gravel, maintained to a depth of 4", with a width of at least 20', extending 100' into the project site. Paving internal roadways can substitute for gravel.

- Internal roadway networks are to be paved as early as feasible in the construction phase. Street sweeping of internal and/or external access roads will likely be required to control entrained road dust.

- Employee parking areas are to be treated with chemical dust suppressants at a mix ratio of no less than 4 to 1 and retreated on a monthly basis, or more frequently if fugitive dust is observed. If internal roadway is complete, employees are to be instructed to park on paved roads.

- Other (specify): _____

Remember...
DUST CONTROL IS REQUIRED 24 HOURS A DAY, 7 DAYS A WEEK,
REGARDLESS OF CONSTRUCTION STATUS

REASONABLY AVAILABLE CONTROL MEASURES

Paragraph (d)(3) of Rule 403 allows activities outside the South Coast Air Basin (see Figure 2-1) to implement reasonably available control measures in lieu of best available control measures. Additionally, as specified by subparagraph (f)(3)(D) of Rule 403, any person seeking approval of a fugitive dust emissions control plan for projects outside the South Coast Air Basin must demonstrate to the satisfaction of the District that the given activity is employing all reasonably available fugitive dust control measures.

The District has prepared the attached listing of reasonably available fugitive dust control measures for a variety of source categories. This list is based on the U.S. Environmental Protection Agency's reference document entitled, "Control of Open Fugitive Dust Sources," Midwest Research Institute, September 1988.

The District encourages the use of those dust control measures that minimize the use of potable water. When water is needed, reclaimed water should be utilized to the greatest extent feasible.

RULE 403 IMPLEMENTATION HANDBOOK

REASONABLY AVAILABLE CONTROL MEASURES

The left column contains a listing of the sources of fugitive dust which are intended for emission control under District Rule 403 and a listing of control measures and high-wind measures. The right column contains a description of the reasonably available fugitive dust control measures for each of the sources.

Source: (1) Land Clearing/Earth-Moving

CONTROL MEASURES

DESCRIPTION

- | | |
|--------------------------------|---|
| (A) Watering | (1) Application of water by means of trucks, hoses and/or sprinklers prior to conducting any land clearing. This will increase the moisture content of the soils; thereby increasing its stability.
(2) Pre-application of water to depths of proposed cuts.
(3) Once the land clearing/earth moving activities are complete, a second application of water can generate a thin crust that stabilizes the disturbed surface area provided that it is not disturbed. (Security fencing can be used to prevent unwanted future disturbances of sites where a surface crust has been created). |
| (B) Chemical stabilizers | (1) Only effective in areas which are not subject to daily disturbances.
(2) Vendors can supply information on product application and required concentrations to meet the specifications established by the Rule. |
| (C) Wind fencing | (1) Three- to five-foot barriers with 50% or less porosity located adjacent to roadways or urban areas can be effective in reducing the amount of windblown material leaving a site.
(2) Would likely be used in conjunction with other measures (e.g., watering, chemical stabilization, etc.) to ensure that visible emissions do not cross a property line. |
| (D) Cover haul vehicles | (1) Entire surface area of hauled earth should be covered once vehicle is full. |
| (E) Bedliners in haul vehicles | (1) When feasible, use in bottom-dumping haul vehicles. |

HIGH WIND MEASURE

- (a) Cease all active operations; or
(b) Apply water within 15 minutes to any soil surface which is being moved or otherwise disturbed.

Source: (2) Unpaved Roads

CONTROL MEASURES

(F) Paving

(G) Chemical stabilization

(H) Watering

(I) Reduce speed limits

(J) Reduce vehicular trips

(K) Gravel

HIGH WIND MEASURE

- (c) Apply a chemical stabilizer (to meet the specifications established by the Rule) prior to wind events; or
- (d) Apply water once each hour; or
- (e) Stop all vehicular traffic.

DESCRIPTION

- (1) Requires street sweeping/cleaning if subject to material accumulation.
- (1) Vendors can supply information as to application methods and concentrations to meet the specifications established by the Rule
- (2) Not recommended for high volume or heavy equipment traffic use.
- (1) In sufficient quantities to keep surface moist.
- (2) Required application frequency will vary according to soil type, weather conditions, and vehicular use.
- (1) 15 mile per hour maximum. May need to be used in conjunction with watering or chemical stabilization to prevent visible emissions from crossing the property line.
- (1) Access restriction or redirecting traffic to reduce vehicle trips by a minimum of 60 percent.
- (1) Gravel maintained to a depth of four inches can be an effective measure.
- (2) Should only be used in areas where paving, chemical stabilization or frequent watering is not feasible.

RULE 403 IMPLEMENTATION HANDBOOK

Source: (3) Storage Piles

CONTROL MEASURES

DESCRIPTION

- (L) Wind sheltering
 - (1) Enclose in silos.
 - (2) Install three-sided barriers equal to height of material, with no more than 50 percent porosity.
- (M) Watering
 - (1) Application methods include: spray bars, hoses and water trucks.
 - (2) Frequency of application will vary on site-specific conditions.
- (N) Chemical stabilizers
 - (1) Best for use on storage piles subject to infrequent disturbances.
- (O) Altering load-in/load-out procedures
 - (1) Confine load-in/load-out procedures to leeward (downwind) side of the material.
 - (2) May need to be used in conjunction with wind sheltering to prevent visible emissions from crossing the property line.
- (P) Coverings
 - (1) Tarps, plastic, or other material can be used as a temporary covering.
 - (2) When used, these should be anchored to prevent wind from removing coverings.

HIGH WIND MEASURE

- (f) Apply chemical stabilizers (to meet the specifications established by the Rule) prior to wind events; or
- (g) Apply water once per hour; or
- (h) Install temporary covers.

Source: (4) Paved Road Track-Out

CONTROL MEASURES

- (Q) Chemical stabilization
- (R) Sweep/clean roadways
- (S) Cover haul vehicles
- (T) Bedliners in haul vehicles
- (U) Site access improvement

DESCRIPTION

- (1) Most effective when used on areas where active operations have ceased.
- (2) Vendors can supply information on methods for application and required concentrations.
- (1) Either sweeping or water flushing may be used.
- (1) Entire surface area should be covered once vehicle is full.
- (1) When feasible, use in bottom dumping vehicles.
- (1) Pave internal roadway system.
- (2) Most important segment, last 100 yards from the connection with paved public roads

HIGH WIND MEASURE

- (i) Cover all haul vehicles; and
- (j) Clean streets with water flushing, unless prohibited by the Regional Water Quality Control Board.

RULE 403 IMPLEMENTATION HANDBOOK

Source: (5) Disturbed Surface Areas/ Inactive Construction Sites

CONTROL MEASURES

DESCRIPTION

- (Q) Chemical stabilization
 - (1) Most effective when used on areas where active operations have ceased.
 - (2) Vendors can supply information on methods for application and required concentrations.
- (R) Watering
 - (1) Requires frequent applications unless a surface crust can be developed.
- (S) Wind fencing
 - (1) Three- to five-foot barriers with 50% or less porosity adjacent to roadways or urban areas can be effective in reducing the amount of wind blown material leaving a site.
- (T) Vegetation
 - (1) Establish as quickly as possible when active operations have ceased.
 - (2) Use of drought tolerant, native vegetation is encouraged.

HIGH WIND MEASURES

- (k) Apply chemical stabilizers (to meet the specifications established by the Rule); or
- (l) Apply water to all disturbed surface areas 3 times per day.

BEST AVAILABLE CONTROL MEASURES

Rule 403, paragraph (d)(2) requires active operations [defined in Rule 403, paragraph (c)(1)] within the South Coast Air Basin (see Figure 2-1) to implement at least one best available control measure for each fugitive dust source type on site. Additionally, as specified by subparagraph (f)(3)(D) of Rule 403, any person seeking approval of a fugitive dust emissions control plan for projects within the South Coast Air Basin must demonstrate to the satisfaction of the AQMD that the given activity is employing all best available fugitive dust control measures.

The AQMD has prepared the attached listing of best available fugitive dust control measures for a variety of source categories. This list is based on the U.S. Environmental Protection Agency's reference document entitled, "Fugitive Dust Background Document and Technical Information Document for Best Available Control Measures," Office of Air and Radiation, September 1992.

The AQMD encourages the use of those dust control measures that minimize the use of potable water. When water is needed, reclaimed water should be utilized to the greatest extent feasible.

RULE 403 IMPLEMENTATION HANDBOOK

BEST AVAILABLE CONTROL MEASURES

The left column contains a listing of the sources of fugitive dust which are intended for emission control under District Rule 403 and a listing of control measures and high-wind measures. The right column contains a description of the best available fugitive dust control measures for each of the sources.

Source: (1) Land Clearing/Earth-Moving

CONTROL MEASURES

DESCRIPTION

- | | |
|--------------------------------|---|
| (A) Watering (pre-grading) | (1) Application of water by means of trucks, hoses and/or sprinklers prior to conducting any land clearing. This will increase the moisture content of the soils; thereby increasing its stability. |
| (A-1) Watering (post-grading) | (2) Pre-application of water to depths of proposed cuts. |
| (A-2) Pre-grading planning | (1) In active earth-moving areas water should be applied at sufficient frequency and quantity to prevent visible emissions from extending more than 100 feet from the point of origin. |
| (B) Chemical stabilizers | (1) Grade each phase separately, timed to coincide with construction phase; or
(2) Grade entire project, but apply chemical stabilizers or ground cover to graded areas where construction phase begins more than 60 days after grading phase ends. |
| (C) Wind fencing | (1) Only effective in areas which are not subject to daily disturbances.
(2) Vendors can supply information on product application and required concentrations to meet the specifications established by the Rule. |
| (D) Cover haul vehicles | (1) Three- to five-foot barriers with 50% or less porosity located adjacent to roadways or urban areas can be effective in reducing the amount of windblown material leaving a site. Must be implemented in conjunction with either measure (A-1) or (B). |
| (E) Bedliners in haul vehicles | (1) Entire surface area of hauled earth should be covered once vehicle is full.
(1) When feasible, use in bottom-dumping haul vehicles. |

HIGH WIND MEASURE

- (a) Cease all active operations; or
- (b) Apply water within 15 minutes to any soil surface which is being moved or otherwise disturbed.

RULE 403 IMPLEMENTATION HANDBOOK

Source: (2) Unpaved Roads

CONTROL MEASURES

DESCRIPTION

- | | |
|----------------------------|---|
| (F) Paving | (1) Requires street sweeping/cleaning if subject to material accumulation. |
| (G) Chemical stabilization | (1) Vendors can supply information as to application methods and concentrations to meet the specifications established by the Rule
(2) Not recommended for high volume or heavy equipment traffic use. |
| (H) Watering | (1) In sufficient quantities to keep surface moist.
(2) Required application frequency will vary according to soil type, weather conditions, and vehicular use. |
| (I) Reduce speed limits | (1) 15 mile per hour maximum. May need to be used in conjunction with watering or chemical stabilization to prevent visible emissions from crossing the property line. |
| (J) Reduce vehicular trips | (1) Access restriction or redirecting traffic to reduce vehicle trips by a minimum of 60 percent. |
| (K) Gravel | (1) Gravel maintained to a depth of four inches can be an effective measure.
(2) Should only be used in areas where paving, chemical stabilization or frequent watering is not feasible. |

HIGH WIND MEASURE

- (a) Apply a chemical stabilizer (to meet the specifications established by the Rule) prior to wind events; or
(b) Apply water once each hour; or
(c) Stop all vehicular traffic.

RULE 403 IMPLEMENTATION HANDBOOK

Source: (3) Storage Piles

CONTROL MEASURES

DESCRIPTION

- | | |
|--|--|
| (L) Wind sheltering | (1) Enclose in silos.
(2) Install three-sided barriers equal to height of material, with no more than 50 percent porosity. |
| (M) Watering | (1) Application methods include: spray bars, hoses and water trucks.
(2) Frequency of application will vary on site-specific conditions. |
| (N) Chemical stabilizers | (1) Best for use on storage piles subject to infrequent disturbances. |
| (O) Altering load-in/load-out procedures | (1) Confine load-in/load-out procedures to leeward (downwind) side of the material.
Must be used in conjunction with either measure (L), (M), (N), or (P). |
| (P) Coverings | (1) Tarps, plastic, or other material can be used as a temporary covering.
(2) When used, these should be anchored to prevent wind from removing coverings. |

HIGH WIND MEASURE

- (a) Apply chemical stabilizers (to meet the specifications established by the Rule) prior to wind events; or
(b) Apply water once per hour; or
(c) Install temporary covers.

RULE 403 IMPLEMENTATION HANDBOOK

Source: (4) Paved Road Track-Out

CONTROL MEASURES

DESCRIPTION

Compliance with District Rule 403.

Paragraph (d)(5).

January 1999

RULE 403 IMPLEMENTATION HANDBOOK

Source: (S) Disturbed Surface Areas/Inactive Construction Sites

CONTROL MEASURES

DESCRIPTION

- (Q) Chemical stabilization
- (1) Most effective when used on areas where active operations have ceased.
- (2) Vendors can supply information on methods for application and required concentrations.
- (R) Watering
- (1) Requires frequent applications unless a surface crust can be developed.
- (S) Wind fencing
- (1) Three- to five-foot barriers with 50% or less porosity adjacent to roadways or urban areas can be effective in reducing the amount of wind blown material leaving a site. Must be used in conjunction with either measure (Q), (R), or (T).
- (T) Vegetation
- (1) Establish as quickly as possible when active operations have ceased.

HIGH WIND MEASURES

- (a) Apply chemical stabilizers (to meet the specifications established by the Rule); or
- (b) Apply water to all disturbed surface areas 3 times per day.

* Use of drought tolerant, native vegetation is encouraged.

TABLE 1

BEST [REASONABLY]* AVAILABLE CONTROL MEASURES FOR HIGH WIND CONDITIONS

FUGITIVE DUST SOURCE CATEGORY	<u>CONTROL MEASURES</u>
Earth-moving	(1A) Cease all active operations; OR (2A) Apply water to soil not more than 15 minutes prior to moving such soil.
Disturbed surface areas	(0B) On the last day of active operations prior to a weekend, holiday, or any other period when active operations will not occur for not more than four consecutive days: apply water with a mixture of chemical stabilizer diluted to not less than 1/20 of the concentration required to maintain a stabilized surface for a period of six months; OR (1B) Apply chemical stabilizers prior to wind event; OR (2B) Apply water to all unstabilized disturbed areas 3 times per day. If there is any evidence of wind driven fugitive dust, watering frequency is increased to a minimum of four times per day; OR (3B) Take the actions specified in Table 2, Item (3c); OR (4B) Utilize any combination of control actions (1B), (2B), and (3B) such that, in total, these actions apply to all disturbed surface areas.
Unpaved roads	(1C) Apply chemical stabilizers prior to wind event; OR (2C) Apply water twice [once] per hour during active operation; OR (3C) Stop all vehicular traffic.
Open storage piles	(1D) Apply water twice [once] per hour; OR (2D) Install temporary coverings.
Paved road track-out	(1E) Cover all haul vehicles; OR (2E) Comply with the vehicle freeboard requirements of Section 23114 of the California Vehicle Code for both public and private roads.
All Categories	(1F) Any other control measures approved by the Executive Officer and the U.S. EPA as equivalent to the methods specified in Table 1 may be used.

* Measures in [brackets] are reasonably available control measures and only apply to sources not within the South Coast Air Basin.

TABLE 2
DUST CONTROL ACTIONS FOR EXEMPTION FROM PARAGRAPH (d)(4)*

<u>FUGITIVE DUST SOURCE CATEGORY</u>	<u>CONTROL ACTIONS</u>
<p>Earth-moving (except construction cutting and filling areas, and mining operations)</p>	<p>(1a) Maintain soil moisture content at a minimum of 12 percent, as determined by ASTM method D-2216, or other equivalent method approved by the Executive Officer, the California Air Resources Board, and the U.S. EPA. Two soil moisture evaluations must be conducted during the first three hours of active operations during a calendar day, and two such evaluations each subsequent four-hour period of active operations; OR (1a-1) For any earth-moving which is more than 100 feet from all property lines, conduct watering as necessary to prevent visible dust emissions from exceeding 100 feet in length in any direction.</p>
<p>Earth-moving: Construction fill areas:</p>	<p>(1b) Maintain soil moisture content at a minimum of 12 percent, as determined by ASTM method D-2216, or other equivalent method approved by the Executive Officer, the California Air Resources Board, and the U.S. EPA. For areas which have an optimum moisture content for compaction of less than 12 percent, as determined by ASTM Method 1557 or other equivalent method approved by the Executive Officer and the California Air Resources Board and the U.S. EPA, complete the compaction process as expeditiously as possible after achieving at least 70 percent of the optimum soil moisture content. Two soil moisture evaluations must be conducted during the first three hours of active operations during a calendar day, and two such evaluations during each subsequent four-hour period of active operations.</p>

* Measures in [brackets] are reasonably available control measures and only apply to sources not within the South Coast Air Basin.

TABLE 2 (Continued)

FUGITIVE DUST SOURCE CATEGORY	CONTROL ACTIONS
Earth-moving: Construction cut areas and mining operations:	(1c) Conduct watering as necessary to prevent visible emissions from extending more than 100 feet beyond the active cut or mining area unless the area is inaccessible to watering vehicles due to slope conditions or other safety factors.
Disturbed surface areas (except completed grading areas)	(2a/b) Apply dust suppression in sufficient quantity and frequency to maintain a stabilized surface. Any areas which cannot be stabilized, as evidenced by wind driven fugitive dust must have an application of water at least twice per day to at least 80 [70] percent of the unstabilized area.
Disturbed surface areas: Completed grading areas	(2c) Apply chemical stabilizers within five working days of grading completion; OR (2d) Take actions (3a) or (3c) specified for inactive disturbed surface areas.
Inactive disturbed surface areas	(3a) Apply water to at least 80 [70] percent of all inactive disturbed surface areas on a daily basis when there is evidence of wind driven fugitive dust, excluding any areas which are inaccessible to watering vehicles due to excessive slope or other safety conditions; OR (3b) Apply dust suppressants in sufficient quantity and frequency to maintain a stabilized surface; OR (3c) Establish a vegetative ground cover within 21 [30] days after active operations have ceased. Ground cover must be of sufficient density to expose less than 30 percent of unstabilized ground within 90 days of planting, and at all times thereafter; OR (3d) Utilize any combination of control actions (3a), (3b), and (3c) such that, in total, these actions apply to all inactive disturbed surface areas.

* Measures in [brackets] are reasonably available control measures and only apply to sources not within the South Coast Air Basin.

January 1999

TABLE 2 (Continued)

<u>FUGITIVE DUST SOURCE CATEGORY</u>	<u>CONTROL ACTIONS</u>
Unpaved Roads	<p>(4a) Water all roads used for any vehicular traffic at least once per every two hours of active operations [3 times per normal 8 hour work day]; OR</p> <p>(4b) Water all roads used for any vehicular traffic once daily and restrict vehicle speeds to 15 miles per hour; OR</p> <p>(4c) Apply a chemical stabilizer to all unpaved road surfaces in sufficient quantity and frequency to maintain a stabilized surface.</p>
Open storage piles	<p>(5a) Apply chemical stabilizers; OR</p> <p>(5b) Apply water to at least 80 [70] percent of the surface area of all open storage piles on a daily basis when there is evidence of wind driven fugitive dust; OR</p> <p>(5c) Install temporary coverings; OR</p> <p>(5d) Install a three-sided enclosure with walls with no more than 50 percent porosity which extend, at a minimum, to the top of the pile.</p>
<u>All Categories</u>	<p>(6a) Any other control measures approved by the Executive Officer and the U.S. EPA as equivalent to the methods specified in Table 2 may be used.</p>

* Measures in [brackets] are reasonably available control measures and only apply to sources not within the South Coast Air Basin.

January 1999

TABLE 3
TRACK-OUT CONTROL OPTIONS
PARAGRAPH (d)(5)(B)

CONTROL OPTIONS

(1)	Pave or apply chemical stabilization at sufficient concentration and frequency to maintain a stabilized surface starting from the point of intersection with the public paved surface, and extending for a centerline distance of at least 100 feet and a width of at least 20 feet.
(2)	Pave from the point of intersection with the public paved road surface, and extending for a centerline distance of at least 25 feet and a width of at least 20 feet, and install a track-out control device immediately adjacent to the paved surface such that exiting vehicles do not travel on any unpaved road surface after passing through the track-out control device.
(3)	Any other control measures approved by the Executive Officer and the U.S. EPA as equivalent to the methods specified in Table 3 may be used.

January 1999

**TRAFFIC SIGNAL AND LIGHTING PROJECT
AT THE INTERSECTION OF
MURRIETA HOT SPRINGS ROAD & WILLOWS AVENUE**

PROJECT NO. C2-0128

SPECIAL PROVISIONS

DESCRIPTION:

In general, this project consists of installing a new traffic signal at the intersection of Murrieta Hot Springs Road and Willows Avenue in the Temecula area of Riverside County. Additional work includes placement of curb and gutter, reconstruction of curb ramps to comply with ADA requirements, pavement markers, roadside signs, salvage roadside signs, replace catch basin, storm drain reinforced concrete pipe, installing painted traffic stripes and thermoplastic crosswalks and pavement markings and any other work as may be required.

SPECIFICATIONS:

This project shall conform to the requirements of the May 2006 edition of the Standard Specifications and Standard Plans as issued by the State of California Department of Transportation.

REFERENCE SPECIFIC BRANDS OR PRODUCTS:

Although the Special Provisions and construction plans reference specific brands or products, the intent of these references is as a guideline only, and products from alternate manufacturers will be accepted, provided that the product and its performance are a close approximation of the specified product. The Contractor shall submit information and specifications of the proposed alternate product to the Engineer for evaluation and approval prior to placing an order with the vendor.

DISPOSAL OF EXCESS EXCAVATION OR MATERIALS:

Excess earth excavation, pavement grindings and other excess materials resulting from construction operations shall be disposed of by the Contractor outside of the highway right of way, as provided in Section 7-1.13 of the Standard Specifications.

The second paragraph of Section 7-1.13 of the Standard Specifications is modified to read as follows:

When any material is to be disposed of outside the highway right of way, and the County of Riverside has not made arrangements for the disposal of such material, the Contractor shall first obtain written authorization from the property owner on whose property the disposal is to be made and he shall file with the Engineer said authorization or a certified copy thereof together with a written release from the property owner absolving the County of Riverside

from any and all responsibility in connection with the disposal of material on said property. If the disposal of materials is to be made at an established disposal facility that is available for public use, the Contractor shall retain all authorizations and receipts from said disposal facility and shall provide copies to the Engineer upon request.

Full compensation for all costs involved in disposing of materials as specified in this section, including all costs of hauling, shall be considered as included in the various contract items of work and no additional compensation will be allowed therefor.

RECORD DRAWINGS:

The Contractor shall keep one clean set of bond originals to note any changes which take place during construction. These changes to the original plans and/or specifications shall be noted at the appropriate locations with the appropriate changes indicated in red pencil or ink. The Contractor shall note in large letters "RECORD DRAWINGS" on the Title Sheet of the plans. The job will not be finalized by the Engineer until these record drawings have been completed to the satisfaction of the Engineer. The changes shall be noted on the plans as the changes occur. The record drawings shall be submitted to the Resident Engineer, and become the property of the County at conclusion of the project.

Full compensation for maintaining and compiling the record drawings shall be considered to be included in other items of work and no additional compensation will be allowed therefore.

COOPERATION:

Attention is directed to Section 7-1.14, "Cooperation" of the Standard Specifications and these Special Provisions.

The Contractor is hereby advised to cooperate with utility companies for adjusting their facilities grade.

The Contractor is hereby advised to cooperate with property owners when working in front of their property.

SURVEY STAKING:

County surveyors will establish external primary survey control marks and/or monuments to be used throughout the construction period. These control marks will be used by the County Surveyor to set construction stakes. The control marks will also be used to make verification surveys at various stages of work.

The County places stakes and marks per the County's Survey Manual.

Contractor must submit request for County furnished stakes:

1. Once staking area is ready for stakes
2. Request for construction stakes must be in writing.

The County will provide Contractor with a survey request form. A minimum notice of 2 working days is required from the Contractor prior to County Surveyor beginning the work requested.

Contractor must preserve stakes and marks placed by the County. Survey costs are incurred by the County; however, if the stakes or marks are destroyed, the County replaces them at the County's earliest convenience and deducts the replacement expenses.

LIQUIDATED DAMAGES:

The Contractor shall diligently prosecute the work to completion before the expiration of **35** working days from the date stated in the "Notice to Proceed". The Contractor shall pay to the County of Riverside the sum of **\$2,500.00** per day, for each and every calendar day's delay in finishing the work in excess of the number of working days prescribed above.

In addition to the liquidated damages set forth above, the Contractor shall pay to the County of Riverside the sum of **\$800.00** per day for each and every calendar day's delay in receiving all of the below listed equipment, onto the job site or at the Contractor's storage facility, and available for installation, within 60 calendar days if standards/posts, anchor bolts and IISNS mast arms were furnished by the County; otherwise, 100 calendar days of the contract award:

1. Traffic Signal Controller Assemblies
2. Service Equipment Enclosures
3. LED Modules
4. IISNS (Street Name Signs)

Additional Liquidated Damages:

In addition to the Liquidated damages set forth above, if the Contractor fails to comply with the requirements of Special Provisions entitled "PROJECT APPEARANCE" the Contractor shall pay to the County of Riverside the sum of **\$500.00** per day for each and every calendar day's delay after the expiration of 48 hours notification from the Engineer.

ITEMS OF WORK:

ORDER OF WORK:

Order of work shall conform to the provisions in section 5-1.05, "Order of Work" of the Standard Specifications and these Special Provisions.

Attention is directed to "Clearing and Grubbing" of these Special Provisions regarding additional work specified in this provision.

PROJECT APPEARANCE:

The Contractor shall maintain a neat appearance to the worksite. The following shall apply:

When practicable, broken concrete and debris developed during clearing and grubbing shall be disposed of concurrently with its removal. If stockpiling is necessary, the material shall be covered daily and removed or disposed of weekly.

The Contractor shall furnish covered trash bins for all debris from structure construction. All debris shall be placed in the covered trash bins daily. Materials, formwork or falsework that is to be reused or salvaged, shall be stacked neatly concurrently with their removal.

Full compensation for conforming to the provisions in this section, not otherwise provided for, shall be considered as included in the prices paid for the various contract items of work involved and no additional compensation will be allowed therefor.

See "Liquidated Damages" Special Provisions for penalties associated with non-compliance.

TRAFFIC CONTROL SYSTEM/ PUBLIC CONVENIENCE/ PUBLIC SAFETY:

Contractor shall prepare construction staging and traffic control plans for review and approval by the Transportation Department at preconstruction conference. The Transportation Department shall have at least two weeks to review and approve the proposed traffic control plans. Construction shall not begin until the Engineer provides Contractor with County approval of the plans.

The construction staging and traffic control plans shall be prepared, signed and stamped by a Civil Engineer or Traffic Engineer who is registered as such in the State of California, unless otherwise specifically allowed by the Engineer. The Contractor shall revise and implement the plans as directed by the Engineer.

Construction staging and traffic control plans shall be in accordance with the appropriate standards and specifications for construction staging, detour roads, traffic control, including the State of California Highway Design Manual, the manual on Uniform Traffic Control Devices 2006 Edition, the corresponding California Supplement, and subsequent modifications as adopted by the State of

California Department of Transportation, Standard Plans and Standard Specifications, and the Work Area Traffic Control Handbook (WATCH), as published by Building News, Inc. Any requests for deviation from the established design standards or specifications are to be submitted to the Construction Engineer for review and approval prior to submission of the required plans.

With regard to the preparation and implementation of the plans, attention is especially directed to Sections 7-1.06, 7-1.08, 7-1.09, 7-1.11, 7-1.12 and Section 12 of the State of California Standard Specifications. Section 12-2.02 of the Standard Specifications is deleted.

Maintaining traffic shall conform to the provisions in 7-1.02 "Load Limitations", 7-1.06 "Safety and Health Provisions", 7-1.08 "Public Convenience", 7-1.09 "Public Safety", and 12-3.04 "Portable Delineators" of the Standard Specifications, the Manual on Uniform Traffic Control Devices 2006 Edition, the corresponding California Supplement, and subsequent modifications as adopted by the State of California Department of Transportation, the Section of these contract documents entitled "Insurance - Hold Harmless", and these Special Provisions.

All existing traffic control signs and street name signs shall be maintained in visible locations as directed by the Engineer.

No detours will be provided, unless specifically allowed herein. The Contractor will be required to conduct his operations in such a manner that traffic will be permitted to pass through the work area with as little delay as possible.

Portable changeable message signs shall be furnished, placed, operated and maintained at those locations shown on the approved Traffic Control Plans or where designated by the Engineer in conformance with the provisions in Section 12, "Construction Area Traffic Control Devices" of the Standard Specifications and these Special Provisions.

All warning lights, signs, flares, barricades and other facilities for the sole convenience and direction of public traffic shall be furnished and maintained by the Contractor. All traffic control devices shall conform to and be placed in accordance with the Manual on Uniform Traffic Control Devices 2006 Edition, the corresponding California Supplement, and subsequent modifications as adopted by the State of California Department of Transportation.

All construction signs shall be either covered or removed when not required by the nature of the work or if no present hazard to the motorist exists.

The Contractor shall notify the appropriate regional notification center for operators of subsurface installations at least 2 working days, but not more than 14 calendar days, prior to commencing excavation for construction area sign posts. The regional notification centers include, but not limited to, the following:

Notification Center	Telephone Number
Underground Service Alert-Southern California (USA)	1-800-422-4133 1-800-227-2600 or 811

Excavations required to install construction area signs shall be performed by hand methods without the use of power equipment, except that power equipment may be used if it is determined there are no utility facilities in the area of the proposed post holes.

No payment for extra work will be allowed for work performed as specified in Section 12-2.02 (Flagging Costs) of the Standard Specifications. Flagging costs will be borne entirely by the Contractor.

Dust control shall conform to the provision of Section 10 of the Standard Specifications except that no extra work will be allowed when the Engineer orders the application of water for the purpose of controlling dust caused by public traffic as provided for in the last paragraph of Section 10.

The Contractor shall be responsible to distribute an information letter pertaining to the planned work to all affected residences and businesses, at least one week prior to commencing work adjacent to those residences and businesses. It shall be the responsibility of the Contractor to design the information letter, obtain design approval from the Engineer, print sufficient copies, and distribute the letter. The Transportation Department logo shall be included on the letter. A computer file of the logo may be obtained from the Engineer in .WPG, .DXF, .DGN or .DWG format. The letter shall be similar to the sample provided by the Engineer, and shall include a project description, the scope of work, the anticipated construction schedule, and other information as appropriate.

The Contractor shall post temporary no parking signs on affected streets 24 hours prior to work on those streets. The temporary no parking signs shall state the anticipated dates and hours of work on those streets.

Method of Payment:

Full compensation, except as otherwise provided herein, for conforming to the requirements of this article, including furnishing, installing and maintaining all traffic control devices shown on the construction staging and traffic control plans and graffiti removal and cleaning, shall be paid for on a lump sum basis, and no additional compensation will be allowed therefor.

MAINTAINING TRAFFIC:

Maintaining traffic shall conform to the provisions in Section 7-1.08, "Public Convenience", Section 7-1.09, "Public Safety" and Section 12, "Construction Area Traffic Control Devices" of the Standard Specifications and "Public Safety" of these Special Provisions.

Closure is defined as the closure of a traffic lane or lanes, including shoulder, ramp or connector lanes, within a single traffic control system.

Closure shall conform to the provisions in "Traffic Control System" of these Special Provisions.

Local authorities shall be notified at least five (5) business days before work begins. The Contractor shall cooperate with local authorities to handle traffic through the work area and shall make arrangements to keep the work area clear of parked vehicles.

Personal vehicles of the Contractor's employees shall not be parked on the traveled way or shoulders including sections closed to public traffic.

When work vehicles or equipment are parked on the shoulder within six (6) feet of a traffic lane, the shoulder area shall be closed.

When work vehicles or equipment are parked on the shoulder within six (6) feet of a traffic lane, the shoulder area shall be closed with fluorescent orange traffic cones or portable delineators placed on a taper in advance of the parked vehicles or equipment and along the edge of the pavement at 25-foot intervals to a point not less than 25 feet past the last vehicle or piece of equipment. A minimum of 9 traffic cones or portable delineators shall be used for the taper. A W20-1 (ROAD WORK AHEAD) or W21-5b (RIGHT/LEFT SHOULDER CLOSED AHEAD) or C24 (CA) (SHOULDER WORK AHEAD) sign shall be mounted on a crashworthy portable sign support with flags. The sign shall be placed where designated by the Engineer. The sign shall be a minimum of 48" x 48" in size. The Contractor shall immediately restore to the original position and location a traffic cone or delineator that is displaced or overturned, during the progress of work.

If minor deviations from the lane requirement chart are required, a written request shall be submitted to the Engineer at least 15 days before the proposed date of the closure. The Engineer may approve the deviations if there is no significant increase in the cost to the County and if the work can be expedited and better serve the public traffic.

Designated County legal holidays are January 1st, the third Monday in January, February 12th, the third Monday in February, the last Monday in May, July 4th, the first Monday in September, the second Monday in October, November 11th, Thanksgiving Day, the Friday following Thanksgiving Day, December 24th and 31st when they fall on Monday, December 25th, December 26th and January 2nd when they fall on Friday, When a designated legal holiday falls on a Sunday, the following Monday shall be a designated legal holiday. When January 1st, February 12th, July 4th, November 11th, or December 25th fall on a Saturday, the preceding Friday shall be a designated legal holiday.

Full compensation for furnishing, erecting, maintaining, removing and disposing of the C43 (CA), W20-1, W21-5b and C24 (CA) signs shall be considered as included in the contract lump sum price paid for Traffic Control System and no additional compensation will be allowed therefor.

GRAFFITI REMOVAL AND CLEANING:

The Contractor shall remove existing graffiti within the project limits and any new graffiti produced during the construction period of the project.

Contractor shall submit a method of graffiti removal plan to the Engineer for approval. Sand blasting will not be allowed. Methods may include but not limited to power washing, solvent washing, and painting over graffiti, as appropriate for the surface to be cleaned.

All graffiti shall be completely removed or obliterated and the area feathered out to hide any imperfections.

Graffiti shall be removed from, but not limited to, the surfaces listed as follows: bricks, cinder blocks, concrete sidewalks, pavement, bridge under passes, overhead structures, drainage channels, roadside signs, temporary construction signs, barricades, k-railing, traffic control devices, all types of poles, and other objects within the project limits as directed by the Engineer. Painting of k-railing for the purposes of graffiti removal shall not be considered as repainting as outlined in paragraph one of Section 12-3.08 and shall not be paid for as extra work.

Graffiti to be removed may include, but shall not be limited to: paint, signs, wood, metal, plastic, decals, gum, markers, crayons, ropes, chains, strings, wires, and tapes of any kind on an as needed basis.

All painting over graffiti must be done with exact color matches, so as not to show any blocking or shadowing of colors. Painting over graffiti is the preferred option on previously painted surfaces, and where solvents are unsuccessful at removing graffiti. Painting services shall be done on an as needed basis on the following types of surfaces, but not limited to: walls, hardscapes, poles, fences, bollards, railings, and buildings.

Paint shall be exact color match. Paint types may include oil base, water base and enamels as approved by the Engineer. Graffiti cover-up by paint will be allowed with appropriate type of paint at locations where graffiti cannot be removed only upon direction by the Engineer. All paint applications shall adhere to the manufacture's recommendations. All material and solutions shall be safe and biodegradable and approved by the Engineer.

Regional Water Quality Control Board (RWQCB) and Air Quality Management District (AQMD) regulations, as well as all NPDES required best management practices shall be complied with and followed.

The Contractor shall so conduct his operation as to cause the least possible obstruction and inconvenience to public traffic. The Contractor shall provide, erect and maintain barricades, lights, danger signals, and warning signs as deemed appropriate by the Engineer.

When necessary, the Contractor shall provide and erect safe and adequate scaffolding and equipment, barriers, and masking, required for the proper execution of the work. All scaffolding shall be properly braced and erected to insure the safety of the workmen and meet all appropriate OSHA regulations.

The Contractor shall respond and provide manpower for any urgent graffiti removal and cleaning notifications within two (2) working days.

When the contract includes a bid item for Construction Site Management, full compensation for conformance with these Graffiti Removal and Cleaning requirements, including labor, equipment, materials, necessary traffic control, and incidentals, shall be paid at the lump sum price for Construction Site Management, and no additional compensation will be allowed therefor.

When the contract does not include a bid item for Construction Site Management, full compensation for conformance with these Graffiti Removal and Cleaning requirements, including labor, equipment, materials, necessary traffic control, and incidentals, shall be paid at the lump sum price for Traffic Control System, and no additional compensation will be allowed therefor.

DEVELOP WATER SUPPLY:

Develop water supply shall conform to the provisions of Section 17 of the Standard Specifications and these Special Provisions.

Attention is directed to the requirements of Section 10, "Dust Control". Water in amounts specified by the Engineer will be used for dust control, and the cost thereof will be included in the lump sum price paid for Dust Abatement.

Method of Payment:

Full compensation for developing water supply and furnishing watering equipment shall be considered as included in the lump sum price paid for "Dust Abatement" and no additional compensation will be allowed therefor.

WATER POLLUTION CONTROL (SANTA MARGRITA WATERSHED):

Throughout the term of this contract, the total land disturbance area of the project site shall be less than 1 acre. The Contractor shall comply the Area-Wide Municipal Stormwater Permit NPDES No. CAS 0108766 hereafter referred to in this section as the "Municipal Permit", issued by the California Regional Water Quality Control Board (CRWQCB) – San Diego Region. This Permit regulates both stormwater and non-stormwater discharges associated with Contractor's construction activities. A copy of the Permit may be obtained at the office of the County of Riverside Transportation Department, 14th Street Transportation Annex, 3525 14th Street, Riverside, California. (951) 955-6780, or may be obtained on the internet at: <http://www.waterboards.ca.gov/sandiego/>

The Contractor shall comply with the requirements of the Municipal Permit, and all other applicable federal, state and local laws, ordinances, statues, rules, and regulations concerning water pollution control.

Contractor's Water Pollution Control Program (WPCP) Preparation Manual shall be prepared by a Qualified SWPPP Developer in accordance with Section 3, "Preparing a Water Pollution Control Program (WPCP)", of the *Caltrans Stormwater Pollution Prevention Plan (SWPPP) and Water Pollution Control Program (WPCP) Preparation Manual (June 2011)*, which is available as a free download from:

<http://www.dot.ca.gov/hq/construc/stormwater/manuals.htm>

WATER POLLUTION CONTROL MEASURES

- A. Work having the potential to cause water pollution shall not commence until the Contractor's WPCP has been reviewed and approved by the Engineer. The Engineer's review and approval of the Contractor's WPCP shall not waive any contractual requirements and shall not relieve the Contractor from achieving and maintaining compliance with all federal, state, and local laws, ordinances, statues, rules, and regulations. A copy of Contractor's WPCP shall be maintained onsite. When the WPCP or access to the construction site is requested by a representative of a federal, state, or

local regulatory agency, Contractor shall make the WPCP available and Contractor shall immediately contact the Engineer. Requests from the public for the Contractor's WPCP shall be directed to the Engineer.

- B. Contractor's WPCP shall describe the Contractor's plan for managing runoff during each construction phase. Contractor's WPCP shall describe the Best Management Practices (BMPs) that will be implemented to control erosion, sediment, tracking, construction materials, construction wastes, and non-stormwater flows. BMP details shall be based upon California Stormwater Quality Association's 2009 California Stormwater Quality BMP Handbook Portal (<http://www.cabmphandbooks.com>) or the Caltrans Construction Site BMP Manual (<http://www.dot.ca.gov/hq/construc/stormwater/manuals.htm>). Contractor's WPCP shall describe installation, operation, inspection, maintenance, and monitoring activities that will be implemented for compliance with the Municipal Permit and all applicable federal, state, and local laws, ordinances, statutes, rules, and regulations related to the protection of water quality.
- C. The Contractor's WPCP preparer shall have been trained to prepare WPCPs or SWPPPs and shall have previous experience with preparing SWPPP or WPCP requirements on a previous project.

The Contractor shall designate a Water Pollution Control Manager that shall have been trained to implement WPCP or SWPPP requirements. Contractor's Water Pollution Control Manager shall:

1. Be responsible for all water pollution control work.
2. Be the Engineer's primary contact for all water pollution control work.
3. Have the authority to mobilize resources (crews, supplies, equipment, etc.) to make immediate repairs of water pollution control measures or to supplement water pollution control measures to maintain compliance with all federal, state, and local laws, ordinances, and regulations related to the protection of water quality, including the Municipal Permit.

The WPCP shall contain all required and applicable certifications and evidence of training for the Water Pollution Control Manager, WPCP Developer, and all other employees working on the project receiving formal training or certification.

- D. Water Pollution Control Training: Contractor shall provide water pollution control training to Contractor's employees and subcontractors prior to their performing work on the work site. The water pollution control training shall be appropriate to the employee or subcontractor function and area of responsibility and shall address (as applicable):
1. Erosion Control (water and wind)
 2. Sediment Control
 3. Tracking Control
 4. Materials & Waste Management
 5. Non-Stormwater Discharge Management
 6. Run-on and Run-off Control

E. Monitoring and Reporting: Observations and inspections conducted by the Contractor's Water Pollution Control Manager shall be documented on the Construction Site Inspection Checklist included in Contractor's WPCP. A copy of each completed Construction Site Inspection Checklist shall be submitted to the Engineer within 24 hours of conducting the inspection.

General Requirements:

In the event the County incurs any Administrative Civil Liability (fine) imposed by the CRWQCB – San Diego Region, the State Water Resources Control Board, or EPA, as a result of Contractor's failure to fully implement the provisions of "Stormwater and Non-Stormwater Pollution Control", the Engineer, may, in the exercise of his sole judgment and discretion, withhold from payments otherwise due Contractor a sufficient amount to cover the Administrative Civil Liability including County staff time, legal counsel, consultant support costs and all other associated cost.

The Contractor shall be responsible for all costs and for any liability imposed by law as a result of the Contractor's failure to comply with the requirements set forth in "Water Pollution Control", including but not limited to, compliance with the applicable provisions of the Caltrans Handbooks, Municipal Permit, Federal, State, and local regulations. For the purpose of this paragraph, costs and liabilities include, but not limited to, fines, penalties, damages, and costs associated with defending against enforcement actions whether taken against the County or the Contractor, including those levied under the Federal Clean Water Act and the State Porter-Cologne Water Quality Act.

Within fifteen (15) working days after the award of the contract, the Contractor shall submit two (2) copies of the WPCP to the Engineer for review and approval. The Contractor shall allow ten (10) working days for the Engineer to review the WPCP. If revisions are required as determined by the Engineer, the Contractor shall revise and resubmit the WPCP within three (3) working days of receipt of the Engineer's comments and shall allow ten (10) working days for the Engineer to review the revisions. The Contractor shall submit four (4) copies of the approved WPCP to the Engineer prior to notice to proceed. The Contractor must have an approved WPCP prior to the notice to proceed. The Engineer may provide a letter of conditional approval of the Contractor's WPCP while minor revisions are made and may allow the Contractor to begin only those certain construction activities identified in the letter of conditional approval. In no case will the conditional approval extend beyond twenty-one (21) calendar days. The Engineer may suspend construction operations until the Contractor submits a revised WPCP that is reviewed and approved by the Engineer.

Unless otherwise directed by the Engineer or specified in these Special Provisions, the Contractor's responsibility for WPCP implementation shall continue throughout any temporary suspension of work ordered in accordance with Section 8-1.05, "Temporary Suspension of the Work", of the Standard Specifications. The Engineer may withhold progress payments or order the suspension of construction operations without an extension of the contract time, if the Contractor fails to comply with the requirements of "Water Pollution Control" as determined by the Engineer.

All BMP repairs shall be implemented by the Contractor within 72 hrs of identification.

Method of Payment:

Payment for Water Pollution Control shall be on a lump sum basis and shall include full compensation for the work performed, including, developing, preparing, revising, obtaining approval of, and amending the WPCP, implementing, installing, constructing, operating, maintaining, and removing and disposing of temporary BMPs, performing the observations, inspections, sampling, analysis, reporting, and street sweeping, and as specified in the Caltrans Handbooks, Municipal Permit and these Special Provisions, and as directed by the Engineer.

STREET SWEEPING:

GENERAL

Summary

This work includes street sweeping.

The WPCP shall describe and include the use of street sweeping as a Water Pollution Control practice for sediment control and tracking control. Street sweeping shall also conform to all applicable AQMD requirements.

Submittals

At least 5 working days before starting clearing and grubbing, or other activities with the potential for tracking sediment or debris, submit:

- A. The number of street sweepers that will be used as described in the WPCP.
- B. Type of sweeper technology (or technologies).

Quality Control and Assurance

Retain the following records related to street sweeping and submit weekly to Engineer:

- A. Tracking Inspection Log
- B. Sweeping times and locations.
- C. Quantity of sweeping waste disposal.

CONSTRUCTION

Street Sweepers

Sweepers must use one of these technologies:

- A. Mechanical sweeper followed by a vacuum-assisted sweeper.
- B. Vacuum-assisted dry (waterless) sweeper.
- C. Regenerative-air sweeper.
- or
- D. Sweeping by hand is acceptable in lieu of A, B, and C above.

Operation

Street sweeping shall be conducted at:

- A. Paved roads at job site entrance and exit locations.
- B. Paved areas within the job site that flow to storm drains or water bodies.

Street sweeping shall be conducted, and sweeper(s) shall be available to operate at all times, for the following:

- A. During clearing and grubbing activities.
- B. During earthwork activities.
- C. During trenching activities.
- D. During roadway structural section activities.
- E. When vehicles are entering and leaving the job site.
- F. After soil disturbing activities.
- G. After observing offsite tracking of material.

Contractor's Water Pollution Control Manager shall inspect adjacent paved areas at job site entrances and exits and paved roadways within the job site on a minimum daily basis, and more frequently when activities that require street sweeping are being performed. Contractor's Water Pollution Control Manager shall maintain a "Tracking Inspection Log." Street sweeping shall be conducted:

- A. Within 1 hour, if sediment or debris is observed on paved areas or paved roadways.

At least one sweeper, in good working order, must be on the job site at all times when sweeping work may be required.

Perform street sweeping to minimize dust. If dust generation is excessive or sediment pickup is ineffective, water may be used but shall be contained, collected (e.g. vacuum), and properly disposed.

Material collected during street sweeping must be removed and disposed of under Section 7-1.13, "Disposal of Material Outside the Highway Right of Way" of the Standard Specifications.

Full compensation to conform with the requirements of this section shall be considered as included in the contract lump sum price paid for Water Pollution Control including furnishing all labor, materials, tools, equipment, and incidentals and for doing all the work involved in street sweeping, including disposal of collected material, as shown on the plans, as specified in the Standard Specifications, these Special Provisions, and as directed by the Engineer. Therefore, no additional compensation will be allowed for street sweeping.

CLEARING AND GRUBBING:

Clearing and grubbing (including removal and disposal of existing storm drain inlets, removal and replacing drip irrigation system within median nose as shown on the plans) shall conform to the provisions in Section 16 of the Standard Specifications.

Shrubs and bushes, inlets and irrigation system shall be removed as directed by the Engineer and disposed of completely.

Removed storm drain inlets, vegetation and hardscape shall be the property of the Contractor and shall be disposed of by the Contractor, as provided in Section 7-1.13 of the Standard Specifications.

For the purpose of making partial payments pursuant to Section 9-1.06, "Partial Payments" of the Standard Specifications, the amount set forth for the contract item of work hereinafter listed shall be deemed to be maximum total value of said contract item of work which will be recognized for progress payment purposes:

Clearing and Grubbing - \$ 2,500.00

After acceptance of the contract pursuant to Section 7-1.17, "Acceptance of Contract" of the Standard Specifications, the amount, if any, payable for a contract item of work in excess of the maximum value for progress payment purposes herein above listed for said item, will be included for payment in the first estimate made after acceptance of the contract.

PAYMENT

Clearing and Grubbing shall be paid on a Lump sum basis.

Full compensation, except as otherwise provided herein, for conforming to the requirements of this article shall be paid for on a lump sum basis and no additional compensation will be allowed therefor.

REMOVE TRAFFIC STRIPES AND PAVEMENT MARKINGS:

Traffic stripes and pavement markings shall be removed as shown on the plans.

The removal of traffic stripes and markings shall be accomplished by either of the following methods.

- A. Wet Sandblasting: Where blast cleaning is used for the removal of painted traffic stripes and pavement markings or for removal of objectionable material, and such removal operation is being performed within Ten (10) feet of a lane occupied by public traffic, the residue including dust shall be removed immediately after contact between the sand and the surface being treated. Such removal shall be by a vacuum attachment operating concurrently with the blast cleaning operation and shall comply with AQMD regulations.
- B. Grinding: A minimum of 3 passes with the grinder in a rectangular area rather than just lettering or markings so the old message cannot be identified is required. Removal shall be to a maximum depth of 1/10". Removal depth may exceed 1/10" only when necessary to effectively remove paint, and only on approval by the Engineer. Asphalt emulsion slurry

shall be applied to the areas where stripes or pavement markings have been removed.

Temporary removal of stripes and pavement markings may be accomplished by either of the above methods or, at the Contractors option, by the application of removable black line mask, 3M Series 145, or approved equal. Obliteration of stripes or pavement markings by applying black paint or asphalt emulsion is not an approved removal method.

After removal of traffic stripes and pavement markings, a fog seal coat shall be applied in conformance with the provisions in Section 37, "Bituminous Seals" of the Standard Specifications and the following:

If removal of existing striping is performed more than 24 hours prior to final striping, the Contractor shall place reflective temporary striping tape throughout the limits of sandblasting, to provide channelization of traffic, for all lanes of travel.

Temporary striping tape shall be removed subsequent to final striping.

Nothing in these Special Provisions shall relieve the Contractor from his responsibilities as provided in Section 7-1.09, "Public Safety," of the Standard Specifications.

It shall be the responsibility of the Contractor to properly dispose of the residue from removal of striping and pavement markings.

Method of Payment:

The price paid per square foot for Removal Traffic Stripes And Pavement Markings shall include full compensation for furnishing all labor materials, tools, equipment and incidentals as shown on the plans and no additional compensation will be allowed therefor.

REMOVE AND SALVAGE ROADSIDE SIGNS:

Existing roadside signs shall be removed and salvaged as shown on the plans.

Existing roadside signs at locations shown on the plans to be removed shall not be removed until replacement signs have been installed or until the existing signs are no longer required for direction of public traffic, unless otherwise directed by the Engineer.

The Contractor shall deliver County owned signs to be salvaged to the nearest County Maintenance Yard located at 23-315 Jefferson Avenue, Murrieta CA 92562 and as directed by the Engineer.

Method of Payment:

The contract unit price paid per each for Remove and Salvage Roadside Signs shall include full compensation for furnishing all labor, materials, tools, equipment and incidentals and for doing all the work including excavation and backfill as specified in the Standard Specification and these Special Provisions and no additional compensation will be allowed therefor.

REMOVE AND RECONSTRUCT EXISTING FACILITIES:

Contractor shall remove and dispose of following existing facilities as shown on the plans to be removed in conformance with Standard Specification, these Special Provisions and as directed by the Engineer.

Existing Pavement for 1' wide slot patch shall be constructed as shown on the plan to grind 0.17' and replacing with 0.17' HMAAC.

Removal and reconstruction of existing median and pavement shall conform to the plans detail "C" & detail "D".

Method of Payment:

Payment for all work involved in the removal and reconstruction of pavement and median will be on a unit price bid as shown on the contract bid Proposal and shall include full compensation for furnishing all labor, materials, tools and equipment, and doing all work involved including saw cut and remove existing facilities, reconstruction of facilities, excavation and backfill, disposal of removed material/debris and no additional compensation will be allowed.

MINOR CONCRETE CURB RAMP, CURB & GUTTER, DRIVEWAY :

Concrete curb ramps, curbs & gutter and driveway shall be constructed in accordance with the County of Riverside Road Improvement Standards and Specifications, in conformance with Sections 51, 73 and 90 of the Standard Specifications, as shown on the plans, and as directed by the Resident Engineer.

Class 3 concrete shall be used for curb ramp, driveway and curb and gutter.

Preparation of subgrade for the concrete structures shall be done in conformance with the requirements of Section 73-1.02 of the Standard Specifications.

The placement of aggregate base material is required under all concrete in accordance with County Road Improvement Standards and Specifications.

Construction of concrete improvements shall include all removal and restoration of the affected irrigation and landscaping, and related work, to return the area adjacent to the new improvements to its original condition and to conform the area to the new improvements.

The area behind and along the concrete improvements shall be filled and compacted with native or select material and graded to match and provide a smooth transition from the edge of the new improvements, to the satisfaction of the Engineer.

Preparation of subgrade for the concrete structures shall be done in conformance with the requirements of Section 73-1.02 of the Standard Specifications. Unless otherwise specified, all curbs and gutters will be backfilled as shown on the plans.

Excess material resulting from the excavation and/or removal of existing concrete curb, gutter, cross gutter, driveway, driveway approach, or ramp including the subgrade, as shown on the plans or as directed by the Resident Engineer, shall be disposed of as elsewhere provided in these Special Specifications.

Full compensation for all costs involved in disposing of materials as specified in this section, including all costs of hauling, shall be considered as included in the various Minor Concrete contract items of work and no additional compensation will be allowed therefor.

The Contractor is responsible for meeting requirements of all American with Disability Act (ADA).

Construction of curb ramps, curb & gutter and driveway shall include, but not be limited to, the following:

- 1) Removal and disposal of existing curb, and/or curb and gutter, spandrel, curb ramp, driveway and driveway approach and existing soil and aggregate as required;
- 2) Establishing grades, and assuring that all grades are met;
- 3) Performing all grading and compaction – including all required aggregate import, as directed by the Engineer and in accordance with County Standard 403;
- 4) Construction of new curb ramp, curb and gutter, driveway and driveway approach;
- 5) All scoring/grooving and required saw cutting;
- 6) Repair of existing asphalt and PCC surfacing;
- 7) Installing 1/2” wide expansion joints;
- 8) All landscaping, and related work, to return the area adjacent to the sidewalk, curb ramps, driveways, driveway approaches, curb and/or curb and gutter to its original condition and to conform the area to the new improvements;

At a minimum, the area from the BCR to ECR shall meet all required ADA standards. Therefore, to conform to existing conditions and/or to achieve the required four-foot level area (maximum of 2.0% crossfall) at the top portion of the curb ramp, it may be necessary to extend the work beyond the BCR/ECR in certain instances.

Full compensation for constructing or furnishing and installing curb ramp detectable warning surfaces shall be considered as included in the contract unit price paid for Minor Concrete (Curb Ramp) and no separate payment will be made therefor.

Method of Payment:

The contract unit bid prices paid per each for Minor Concrete (Curb Ramp) and per linear foot for Minor Concrete (Curb and Gutter), and per each for driveway shall include full compensation for furnishing all labor, equipment, materials and tools, and incidentals, and for doing all the work involved in the construction and complete in place including the furnishing and placing of expansion joints.

AGGREGATE BASE:

Aggregate base shall be Class 2 and shall conform to the provisions in Section 26, “Aggregate Bases” of the Standard Specifications and these Special Provisions and shall meet the gradation requirements for ¾ inch maximum.

The first paragraph of Section 26-1.02A, “Class 2 Aggregate Base” shall be modified to read:

Aggregate for Class 2 aggregate base shall be free from organic matter and other deleterious matter, and shall be of such nature that it can be compacted readily under watering and rolling to form a firm and stable base. Aggregate may consist of broken and crushed asphalt concrete or Portland cement concrete and may contain crushed aggregate base or other rock materials. The material may contain no more than 3 percent brick by weight as determined by California Test Method 202 as modified: Brick material retained on a No.4 sieve shall be identified visually and separated manually. Brick quantification shall be based on total weight of dry sample. Also, material retained on the 4.75 mm (No.4) sieve shall contain no more than 15 percent of particles (gravel) that have no more than one fractured face.

The Quality Requirements contained in Section 26-1.02A shall be modified to read:

QUALITY REQUIREMENTS

Test	Contract Compliance
Resistance (R-Value)	
Virgin Rock	78 Minimum
Crushed Miscellaneous	80 Minimum
Sand Equivalent	35 Minimum
Durability Index	35 Minimum
Percentage Wear	
100 Revolutions	15 Maximum
500 Revolutions	52 Maximum

Method of Payment:

Quantities of Aggregate Base material for curb & gutter, curb ramp, cross gutter and spandrel shall be considered as included in the bid unit price for these structures and no additional compensation will be allowed therefor.

The quantity of Aggregate Base material for Bid item 10, (Grind and replace pavement for 1' wide slot patch) and Bid item 13, (Remove existing median and pavement and reconstruct per detail "C") shall be considered as included in the bid price paid for the Bid items 10 and 13.

HOT MIX ASPHALT:

Asphalt concrete shall be Type "A" and shall conform to the requirements of Section 39 of the Standard Specifications and the following:

Aggregate grading shall be three-quarter inch (3/4") maximum, medium.

The asphalt lift thickness table, as shown in Section 39-6.01, "General Requirements" of the Standard Specifications, is revised as follows:

Total Thickness Shown on Plans	Minimum No. of Layers	Top Layer Thickness (foot)		Next Lower Layer Thickness (foot)		All Other Lower Layer Thickness (foot)	
		Min.	Max.	Min.	Max.	Min.	Max.
0.24-foot or less ^a	1	-	-	-	-	-	-
0.25-foot	2 ^b	0.12	0.13	0.12	0.13	-	-
0.26 - 0.46 foot	2	0.12	0.21	0.14	0.25	-	-
0.47-foot or more	3 or more	0.15	0.21	0.15	0.25	0.17	0.25

Footnotes to asphalt thickness table are revised as follows:

- a. No Change.
- b. One layer of 0.25 foot thick may be placed as approved by the Engineer. When the Traffic Index specified is 5.5 or below, two layers shall be placed.

ASPHALTS

Asphalt shall conform to the provisions in this Section, "Asphalts". Section 92, "Asphalts" of the Standard Specifications shall not apply.

Asphalt shall consist of refined petroleum or a mixture of refined liquid asphalt and refined solid asphalt, prepared from crude petroleum. Asphalt shall be:

1. Free from residues caused by the artificial distillation of coal, coal tar, or paraffin;
2. Free from water;
3. Homogeneous.

GENERAL

The Contractor shall furnish asphalt in conformance with the State of California Department of Transportation's "Certification Program for Suppliers of Asphalt". The Department maintains the program requirements, procedures, and a list of approved suppliers at:

<http://www.dot.ca.gov/hq/esc/Translab/fpmcoc.htm>.

The Contractor shall ensure the safe transportation, storage, use, and disposal of asphalt.

The Contractor shall prevent the formation of carbonized particles caused by overheating asphalt during manufacturing or construction.

GRADE

Performance graded (PG) asphalt binder shall conform to the following:

Property	AASHTO Test Method	Specification Grade		
		PG 64-10	PG 64-16	PG 70-10
Original Binder				
Flash Point, Minimum °C	T48	230	230	230
Solubility, Minimum % ^b	T44	99	99	99
Viscosity at 135 °C, Maximum, Pa·s	T316	3.0	3.0	3.0
Dynamic Shear, Test Temp. at 10 rad/s, °C Minimum $G^*/\sin(\delta)$, kPa	T315	64 1.00	64 1.00	70 1.00
RTFO Test ^e , Mass Loss, Maximum, %	T240	1.00	1.00	1.00
RTFO Test Aged Binder				
Dynamic Shear, Test Temp. at 10 rad/s, °C Minimum $G^*/\sin(\delta)$, kPa	T315	64 2.20	64 2.20	70 2.20
Ductility at 25 °C Minimum, cm	T51	75	75	75
PAV ^f Aging, Temperature, °C	R28	100	100	110
RTFO Test and PAV Aged Binder				
Dynamic Shear, Test Temp. at 10 rad/s, °C Maximum $G^*/\sin(\delta)$, kPa	T315	31 ^d 5000	28 ^d 5000	34 ^d 5000
Creep Stiffness, Test Temperature, °C Maximum S-value, Mpa Minimum M-value	T313	0 300 0.300	-6 300 0.300	0 300 0.300

Notes:

- a. Not used.
- b. The Engineer will waive this specification if the supplier is a Quality Supplier as defined by Department's "Certification Program for Suppliers of Asphalt".
- c. The Engineer will waive this specification if the supplier certifies the asphalt binder can be adequately pumped and mixed at temperatures meeting applicable safety standards.
- d. Test the sample at 3 °C higher if it fails at the specified test temperature. $G^*/\sin(\delta)$ shall remain 5000 kPa maximum.
- e. "RTFO Test" means the asphaltic residue obtained using the Rolling Thin Film Oven Test, AASHTO Test Method T240 or ASTM Designation: D2827.
- f. "PAV" means Pressurized Aging Vessel.

Performance graded polymer modified asphalt binder (PG Polymer Modified) is:

Performance Graded Polymer Modified Asphalt Binder ^a

Property	AASHTO Test Method	Specification Grade		
		PG 58-34 PM	PG 64-28 PM	PG 76-22 PM
Original Binder				
Flash Point, Minimum °C	T 48	230	230	230
Solubility, Minimum % ^b	T 44 ^c	98.5	98.5	98.5
Viscosity at 135°C, ^d Maximum, Pa·s	T 316	3.0	3.0	3.0
Dynamic Shear, Test Temp. at 10 rad/s, °C Minimum G*/sin(delta), kPa	T 315	58 1.00	64 1.00	76 1.00
RTFO Test , Mass Loss, Maximum, %	T 240	1.00	1.00	1.00
RTFO Test Aged Binder				
Dynamic Shear, Test Temp. at 10 rad/s, °C Minimum G*/sin(delta), kPa	T 315	58 2.20	64 2.20	76 2.20
Dynamic Shear, Test Temp. at 10 rad/s, °C Maximum (delta), %	T 315	Note e 80	Note e 80	Note e 80
Elastic Recovery ^f , Test Temp., °C Minimum recovery, %	T 301	25 75	25 75	25 65
PAV ^g Aging, Temperature, °C	R 28	100	100	110
RTFO Test and PAV Aged Binder				
Dynamic Shear, Test Temp. at 10 rad/s, °C Maximum G* sin(delta), kPa	T 315	16 5000	22 5000	31 5000
Creep Stiffness, Test Temperature, °C Maximum S-value, MPa Minimum M-value	T 313	-24 300 0.300	-18 300 0.300	-12 300 0.300

Notes:

- a. Do not modify PG Polymer Modifier using acid modification.
- b. The Engineer waives this specification if the supplier is a Quality Supplier as defined by the Department's "Certification Program for Suppliers of Asphalt".
- c. The Department allows ASTM D5546 instead of AASHTO T44.
- d. The Engineer waives this specification if the supplier certifies the asphalt binder can be adequately pumped and mixed at temperatures meeting applicable safety standards.
- e. Test temperature is the temperature at which G*/sin(delta) is 2.2 kPa. A graph of log G*/sin(delta) plotted against temperature may be used to determine the test temperature when G*/sin(delta) is 2.2 Kpa. A graph of (delta) versus temperature may be used to determine delta at the temperature when G*/sin(delta) is 2.2 kPa. The Engineer also accepts direct measurement of (delta) at the temperature when G*/sin(delta) is 2.2 kPa.
- f. Test without a force ductility clamp may be performed.
- g. "PAV" means Pressurized Aging Vessel.

SAMPLING

Provide a sampling device in the asphalt feed line connecting the plant storage tanks to the asphalt weighing system or spray bar. Make the sampling device accessible between 24 and 30 inches above the platform. Provide a receptacle for flushing the sampling device.

Include with the sampling device a valve:

1. Between 1/2 and 3/4 inch in diameter;
2. Manufactured in a manner that a one-quart sample may be taken slowly at any time during plant operations;
3. Maintained in good condition.

The Contractor shall replace failed valves.

In the Engineer's presence, take 2 one-quart samples per operating day. Provide round, friction top, one-quart containers for storing samples.

APPLYING ASPHALT

Unless otherwise specified, the Contractor shall heat and apply asphalt in conformance with the provisions in Section 93, "Liquid Asphalts" of the Standard Specifications.

Section 39-2.01, "Asphalts" is replaced in its entirety with the following:

Asphalt binder to be mixed with aggregate shall conform to the provisions in "Asphalts" of these Special Provisions.

The grade of asphalt binder shall be PG 64-10.

Liquid asphalt for prime coat shall conform to the provisions in Section 93, "Liquid Asphalts" of the Standard Specifications and shall be PG 64-10 unless otherwise designated by the contract item or otherwise specified in the Special Provisions.

Asphaltic emulsion for paint binder (tack coat) shall conform to the provisions in Section 94, "Asphaltic Emulsion" of the Standard Specifications for the rapid-setting or slow-setting type and grade approved by the Engineer.

Section 39-3.01B (1) shall be amended to include:

Aggregate of the 3/4 inch or 1/2 inch maximum size and aggregate for asphalt concrete base shall be separated into 3 or more sizes and each size shall be stored in separate bins. If 3 sizes are used, one bin shall contain that portion of the material which will pass the maximum size specified and be retained on a 3/8 inch sieve; one bin shall contain that portion of the material which will pass a 3/8 inch sieve and be retained on a No. 8 sieve; and one bin shall contain that portion of the material which will pass a No. 8 sieve.

Aggregate of 3/8 inch maximum size shall be separated into 2 sizes and each size shall be stored in separate bins. One bin shall contain that portion of the material which will pass the maximum size specified and be retained on a No. 8 sieve and one bin shall contain that portion of the material which will pass a No. 8 sieve.

The bin containing the fine material shall not contain more than 15 percent of material retained on the No. 8 sieve. The material in any of the other bins shall not contain more than 15 percent of material passing a No. 8 sieve. Failure to comply with this requirement shall be corrected immediately, and the material in the bins not meeting these requirements shall be re-screened or wasted.

All asphalt concrete for this project shall be supplied from one source unless approved by the Engineer. Said source shall be listed on the Contractors Source of Materials List as required in Section 6 of the Standard Specifications.

Asphaltic emulsion shall be furnished and applied as provided in Section 39-4.02.

Method of Payment:

Full compensation for furnishing and applying Hot Mix Asphalt Concrete (HMAC) including asphaltic emulsion (paint binder/tack coat) will not be paid separately and shall be considered as included in bid item where HMAC is required as a combined item, including mineral aggregate and asphalt binder (tack coat) and no additional compensation will be allowed.

MINOR CONCRETE STRUCTURES:

Minor concrete structures shall conform to the applicable portions of Section 51, 52, 75 and 90 of the Standard Specifications, these Special Provisions, the Standard Plans, the plans and as directed by the Resident Engineer.

Minor concrete structures for this project shall consist of:

- 24" x 24" Catch Basin as shown on the plan Detail "B".
- Concrete Bulkhead per RCFC&WCD Standard No. M816
- Junction Structure No. 1 per RCFC&WCD Standard No. JS226

Concrete to be used in the construction of minor concrete structures shall be Class "2" concrete.

Preparation of subgrade for the concrete structures shall be done in conformance with the requirements of Section 73-1.02 of the Standard Specifications.

Excess material resulting from the excavation shall be disposed of as elsewhere provided in these Special Specifications. Full compensation for the removal of existing concrete structures shall be included in the contract bid prices for such items.

All exposed metal shall be galvanized in conformance with Section 75-1.05 of the Standard Specifications.

Method of Payment:

The minor concrete structures as listed in the bid proposal will be paid per unit. The contract prices paid for minor concrete structures listed above will not be adjusted if the constructed height of said minor structure, including revisions by Engineer, is within +/- 0.5 foot of the vertical dimension shown on the plans.

Payment for all work involved in the construction of minor structures will be on a unit price bid as shown on the contract bid Proposal and shall include full compensation for furnishing all labor, materials, tools and equipment, and doing all work involved in the complete structure, including the construction of structure excavation and backfill, remove and dispose of existing concrete inlets, furnishing and placing reinforcement, and metal frames, covers and grates and no further allowances shall be allowed.

REINFORCED CONCRETE PIPE:

Reinforced concrete pipe shall conform to the provisions in Section 65, "Reinforced Concrete Pipe" of the Standard Specifications and these Special Provisions.

GENERAL

Pipe shall be placed under existing paving in a trench 12" minimum wider than the outside diameter of the pipe being installed. Trenching shall be 6" minimum in width on each side of the pipe.

Pavement shall be cut to a depth of 3" with an abrasive type saw or with a rock cutting excavator specifically designed for this purpose. Cuts shall be neat and true with no shatter outside the removal area.

The D- loading for the proposed reinforced concrete pipes is 2000D.

If directed by the Engineer, temporary road steel plates shall be installed over the trench and recessed to the existing pavement along the edges of the plates to allow traffic movements until the new asphalt concrete is installed or as directed by the Engineer.

The pipe shall be placed in the bottom of the trench and the trench shall be backfilled with two sack slurry to finish grade.

Prior to final paving, the top of the slurry backfill shall be pulverized with existing pavement section to allow the final pavement surface or as directed by the Engineer.

If so directed by the Engineer, the two sack slurry backfill shall be installed to a depth of 0.30' below the final pavement surface.

The slurry shall be allowed to cure a minimum of two days prior to final paving.

Slurry cement backfill shall conform to Section 19-3.062 of the Standard Specifications, except for full compensation therefor shall be considered as included in the prices paid for the contract unit bid paid per linear foot for Reinforced Concrete Pipe of the types specified in the bid items list and no additional compensation will be allowed therefor.

Full compensation for providing, installing and maintaining temporary road steel plates shall be considered as included in the prices paid per linear foot for Reinforced Concrete Pipe of the types specified in the bid items list and no additional compensation will be allowed therefor.

Except as otherwise designated by classification on the plans or in the specifications, joints for culvert and drainage pipes shall conform to the plans or specifications for standard joints.

MATERIALS

The concrete for reinforced concrete pipe shall contain not less than 470 pounds of cementitious material per cubic yard and have a water-cementitious material ratio that does not exceed 0.40 by weight. Supplementary cementitious material is optional. Reinforcement shall have a minimum cover of 1 inch.

Special reinforced concrete pipe, having concrete cover over the steel reinforcement greater than the cover specified in AASHTO Designation: M 170, shall conform to the provisions in Section 65-1.02, "Materials" and Section 65-1.02A, "Circular Reinforced Concrete Pipe" of the Standard Specifications, except the width of crack produced by the D-load test specified in AASHTO Designation: M 170 shall be the width determined by the following formula:

$$b = \frac{t - 3/8d}{t - 3/8d - C} \times 0.01 \text{ inch}$$

Where:

- b = Width of crack to be produced in lieu of the 0.01-inch crack specified in AASHTO Designation: M 170
- t = Wall thickness of pipe, inches
- d = Effective depth of the section to be tested, feet
- C = Concrete cover over steel reinforcement in excess of cover specified in AASHTO Designation: M 170

Reinforced concrete pipe that is to be hydrostatically tested shall be strength tested by the 3-edge bearing method to a maximum D-load of 10 percent greater than the 0.01-inch cracking D-load specified in AASHTO Designation: M 170 or to the actual D-load required to produce a 0.01-inch crack, whichever is the lesser.

Special oval shaped reinforced concrete pipe, having concrete cover over the steel reinforcement greater than the cover specified in AASHTO Designation: M 207, shall conform to the provisions in Section 65-1.02, "Materials" and Section 65-1.02B, "Oval Shaped Reinforced Concrete Pipe" of the

Standard Specifications, except the width of crack produced by the D-load test specified in AASHTO Designation: M 207 shall be the width determined by the following formula:

$$b = \frac{t - 3/8d}{t - 3/8d - C} \times 0.01 \text{ inch}$$

Where:

- b = Width of crack to be produced in lieu of the 0.01-inch crack specified in AASHTO Designation: M 207
- t = Wall thickness of pipe, inches
- d = Effective depth of the section to be tested, feet
- C = Concrete cover over steel reinforcement in excess of cover specified in AASHTO Designation: M 207

Oval shaped reinforced concrete pipe that is to be hydrostatically tested shall be strength tested by the 3-edge bearing method to a maximum D-load of 10 percent greater than the 0.01-inch cracking D-load specified in AASHTO Designation: M 207 or to the actual D-load required to produce a 0.01-inch crack, whichever is the lesser.

Method of Payment:

The County does not pay any additional cost for excess concrete cover over steel reinforcement.

The contract unit bid price paid per linear foot for Reinforced Concrete Pipe shall include full compensation for furnishing all labor, materials, tools, equipment, and incidentals, and for doing all the work involved including structures excavation and slurry backing, as shown on the plans, as specified in the Standard Specifications and these Special Provisions, and as directed by the Engineer.

ROADSIDE SIGNS:

The Contractor shall furnish and install roadside signs at the locations shown on the plans or as directed by the Engineer, in conformance to the provisions in Section 56-2 "Roadside Signs," of the State Standard Specifications, and these Special Provisions.

All roadway signs shall have retroreflective sheeting. Except as stated below, the retro-reflectivity for all roadway signs, both temporary and permanent installations, shall meet or exceed ASTM Standard D 4956 Type III (3M Co. High Intensity Grade or approved equal). The retroreflectivity for R1-1 ("STOP") signs and W3-1 (Stop Ahead) signs shall meet ASTM Standard D 4956 Type IX (3M Co. Diamond Grade or approved equal).

Method of Payment:

The contract unit price paid per each for Roadside Signs shall included full compensation for furnishing all labor, materials, tools, equipment, and incidentals and for doing all the work including all necessary concrete excavation and backfill as specified in the Standard Specifications and these

Special Provisions and no additional compensation will be allowed therefor.

PAINT TRAFFIC STRIPE (2 COATS):

Painting traffic stripe shall conform to the provisions in Sections 84-1, "General" and 84-3, "Painted Traffic Stripes and Pavement Markings" of the Standard Specifications and these Special Provisions.

Traffic striping shall be applied in two coats with airless equipment and shall be performed with a roadliner truck mounted striping machine. Where the configuration or location of a traffic stripe is such that the use of a roadliner truck mounted striping machine is unsuitable, traffic striping and glass spheres may be applied by other methods and equipment approved by the Engineer.

Newly painted traffic striping shall be protected from damage by public traffic or other causes until the paint is thoroughly dry. Any newly painted traffic striping which are damaged as a result of the construction, including wheel markings by public traffic and the construction equipment, shall be repainted by the Contractor and any associated removals shall be performed as called for in these Special Provisions.

Method of Payment:

The contract unit price paid per linear foot for Paint Traffic Stripe (2 Coats) shall include full compensation for furnishing all labor, materials, tools, equipment and incidentals, and for doing all the work involved in painting traffic stripe (Regardless of the number, widths, and types of individual stripes involved in each traffic stripe) including any necessary cat tracks, dribble lines any layout work, complete in place as shown on the plans, as specified in the Standard Specifications and these Special Provisions, and as directed by the Engineer.

THERMOPLASTIC CROSSWALK AND PAVEMENT MARKING:

Thermoplastic crosswalk and pavement marking shall conform to the provisions in Sections 84-1, "General" and 84-2, "Thermoplastic Traffic Stripes and Pavement Markings" of the Standard Specifications, the plans, these Special Provisions and as directed by the Engineer.

Method of Payment:

The contract price paid per square foot for Thermoplastic Crosswalk and Pavement Marking shall include full compensation for furnishing all labor, materials, tools, equipment, and incidentals and for doing all the work necessary to place the crosswalk and pavement markings complete in place, and no additional compensation will be allowed.

PAVEMENT MARKERS (REFLECTIVE):

Pavement markers (reflective) shall conform to the provisions in Section 85, "Pavement Markers" of the Standard Specifications and these Special Provisions.

Pavement markers shall be placed to the line established by the Engineer. All additional work necessary to establish satisfactory lines for markers shall be performed by the Contractor.

Pavement markers shall be installed where indicated on the plans in accordance with the indicated striping detail. Refer to Standard Plans A20-A through A20-D for striping and markings details.

Markers and adhesive removal shall be performed by a method approved by the Engineer. Any pavement scarring resulting from the markers removal shall be repaired to the satisfaction of the Engineer.

Method of Payment:

Payment for furnishing and placing Pavement Markers (Reflective) will be at the unit price bid and shall include full compensation for furnishing all labor, materials, tools, equipment and no additional compensation will be allowed therefor.

FINISHING ROADWAY:

Finishing roadway shall conform to Section 22 of the Standard Specifications and as directed by the Resident Engineer.

Method of Payment:

Full compensation, except as otherwise provided herein, for conforming to the requirements of this article shall be considered as included in various items of work and no additional compensation will be allowed therefor.

OBSTRUCTIONS:

Attention is directed to Sections 8-1.10, "Utility and Non-Highway Facilities", and 15, "Existing Highway Facilities" of the Standard Specifications and these Special Provisions.

Existing utility and privately owned facilities shall be protected in accordance with Section 7-1.11, "Preservation of Property" and these Special Provisions. The Contractor is also responsible to protect those facilities that are to be relocated by others prior to or during construction, and shall protect those facilities in both their existing and their ultimate locations. The Contractor shall cooperate with owners and their Contractors of utility and privately owned facilities, for the relocation of said facilities, in accordance with Section 7-1.14, "Cooperation" of the Standard Specifications.

All water valves and covers, gas valves and covers, sewer manholes, survey monuments, survey markers and any other utility appurtenances shall be protected in place.

The Contractor's attention is directed to the existence of certain underground facilities that may require special precautions be taken by the Contractor to protect the health, safety and welfare of workmen and the public. Facilities requiring special precautions include, but are not limited to: conductors of petroleum products, oxygen, chlorine, and toxic or flammable gases; natural gas in pipe lines greater than 6 inches in diameter or pipe lines operating at pressures greater than 60 psi (gage); underground electric supply system conductors or cables either directly buried or in duct or conduit which do not have concentric neutral conductors or other effectively grounded metal shields or sheaths; and underground electrical conductors with potential to ground of more than 300 volts. The Contractor shall notify the Engineer at least twenty-four hours prior to performing any work in the vicinity of such facilities.

Attention is directed to the requirements of Government Code Sections 4216-4216.9 pertaining to existing utility facilities.

The Contractor shall assume that every house, building and lot within the project limits has utility service pipes and conductors (laterals), and that utility main and trunk facilities exist within the project limits. The Contractor shall determine if it is warranted to determine the exact location of these utility service laterals and existing main lines, unless directed by the Engineer to pot-hole at specific locations, or as otherwise required herein. The Contractor will not be directly reimbursed for determining the exact location of the utility main lines or services laterals but shall include any compensation for this work in the contract price paid for the various items of work. Any damage to existing main lines or service laterals for which pot-holing was not performed shall be considered damage due to not using reasonable care and the damage shall be repaired at the Contractor's expense.

The Contractor shall conduct his operations with the assumption that underground utility facilities exist within the project limits. The Contractor shall exercise caution and best construction practices for safety and for protection of underground facilities. The approximate locations of underground utility facilities, as shown on the plans, are based on information provided by the respective owners, listed below. The Contractor shall also utilize the markings of the regional notification center (Underground Service Alert), and above-ground utility appurtenances to determine the existence and approximate location of underground utilities.

No excavation shall be made within 4 feet of any underground utilities, as shown on the plans and/or marked by Underground Service Alert, unless and until such utilities have been positively located as to horizontal and vertical position. This requirement applies to all underground electric, natural gas, toxic or flammable gas, chlorine, oxygen or petroleum facilities.

Forty-eight hours prior to beginning construction, the Contractor shall notify the following agencies:

Underground Service Alert	800-227-2600
Southern California Edison Company	951-928-8318
Southern California Gas Company	818-701-4546
Southern California Gas Company	909-335-7561
Sprint Communication	909-873-8022
Verizon Communications	951-925-5319
Level 3	720-888-3813

Sunesys, LLC	951-278-0400
MCI network Services	972-729-6016
Santa Ana Watershed	951-354-4220
AT & T Long Distance	714-963-7964
Time Warner Telecom	925-953-7093
Time Warner Cable	951-634-1189
Eastern Municipal Water District	951-928-6107
Municipal Water District	213-217-6961

Adjustments to Grade for Obstructions

The Contractor shall adjust to finish grade any valve covers encountered within the project limits, as required, for those utility valves that are provided with slip cans and are adjustable without the replacement of parts or the removal of concrete collars. In cases where the owning utility company insists upon upgrades in the standards, or when additional parts or the removal of concrete collars are required for the adjustment, said adjustment will be the responsibility of the owning utility company.

Communication and coordination with the owning utility company shall be the responsibility of the contractor.

For public safety, traffic shall not be allowed on temporary or permanent pavement until all manholes are either adjusted to grade or otherwise protected, as approved by the Engineer. The Contractor shall adjust to grade manholes and valves when and as necessary for the protection of the traveling public during construction, and shall coordinate all work on said facilities with the owning utility companies. This requirement is intended for traffic that is to be allowed on temporary surfaces during the course of construction. Final adjustment to grade will be the responsibility of the owning utility company, except as provided herein.

Said work shall be performed in accordance with Section 15-2.05A, "Frames, Covers, Grates, and Manholes" of the Standard Specifications. Full compensation for adjustment of valve covers shall be considered as included in the contract price paid for asphalt concrete, or applicable items of work in the event that there is no asphalt concrete bid item, and no additional compensation will be allowed therefor.

All existing utility facilities shall be protected from damage by the Contractor's operations.

Unless otherwise provided herein, the owning utility companies will not be obligated to lower their surface utilities (manholes and valve covers) for Contractor's grading, grinding and/or paving operations. The contractor shall lower surface facilities, including manholes and valve covers, to facilitate construction, and the following shall apply:

1. Contractor shall coordinate all work with the utility owner.
2. Contractor shall be responsible for all costs and shall be responsible for any damage caused to the owner's facilities. If the Contractor observes any pre-existing damage to the

utility facilities, the Contractor shall notify the Engineer and the utility owner of that damage prior to performing additional work on the facility.

3. Contractor shall, after removing grade rings and covers, arrange for pickup by, or delivery to, the owner's yard. Any and all concrete collars removed by the Contractor shall become the property of the Contractor, and shall be disposed of as specified elsewhere in these special provisions.
4. The Contractor is advised that he is responsible for ensuring that construction materials do not enter the utility owner's facilities. The Contractor shall install traffic bearing steel plates for this purpose, and provide all coordination and transportation necessary. It is recommended that the Contractor request the utility owner to provide such steel plates. If the Contractor provides steel plates, it shall be the Contractor's responsibility to coordinate with the utility owner for the return of the steel plates to the Contractor after final adjustment to grade. If the Contractor utilizes utility owner's steel plates, and if the Contract items of work include adjustment to final grade, the Contractor shall return the steel plates to the Utility owner's yard, or as otherwise arranged with the Utility owner.
5. Prior to paving or covering the plated utility facility, the Contractor shall tie-out the facility utilizing a method acceptable to the utility owner and provide notes and data of all covered facilities to both the utility owner and the Engineer.
6. The Contractor shall notify the utility owner, upon completion of the Contractor's work, when the utility owner may move in to make the final adjustments to grade.
7. The requirements for lowering of surface facilities shall not apply to vaults. The Contractor shall notify the utility owner of the need to make adjustments to such major facilities.
8. The Contractor is reminded that the utility facilities are owned by public and private utility companies that operate their facilities within public rights of way. The utility owner's preferences with regards to the handling of its facilities shall be complied with to the greatest extent feasible.

Method of Payment

Full compensation for all costs, including labor, equipment, materials and incidentals, required to comply with the requirements of this section above, including protection of water valves and covers, gas valves and covers, sewer manholes, survey monuments, survey markers and any other utility appurtenances, shall be considered as included in the various items of work, and no additional compensation will be allowed therefor.

Full compensation for initial lowering of surface utilities facilities shall be considered as included in the contract price paid for asphalt concrete, or applicable items of work in the event that there is no asphalt concrete bid item, and no additional compensation will be allowed therefor.

SIGNAL AND LIGHTING

A. General

Furnishing and installing traffic signal and highway lighting systems, and payment shall conform to the provisions in Section 86, "Signals, Lighting and Electrical Systems", of the latest edition Standard Specifications, amendments to the Standard Specifications, and these Special Provisions.

B. Start of Work

Location where signalization and highway lighting work is to be performed:

	Location	Area
1.	Murrieta Hot Springs Rd & Willows Ave	Temecula

C. County Furnished Equipment

County furnished equipment shall conform to the provisions in Section 6-1.02, "State Furnished Materials", of the Standard Specifications and these Special Provisions.

The County of Riverside will furnish the following equipment and materials to the Contractor for installation:

1. Signal and Lighting Standards and Anchor Bolts
2. 10' Galvanized Steel IISNS Mast Arms

The Contractor shall pick up County furnished equipment and materials from the following location(s), or as directed by the Engineer, and transport them to the project site(s):

County Maintenance District Yard
23-315 Jefferson Avenue
Murrieta, CA 92562
District Supervisor: Jerry Lytle
Telephone (951) 677-5889

Any County furnished equipment that is damaged after the Contractor has taken possession of the items shall be repaired to the satisfaction of the Engineer. If the damaged equipment is considered irreparable, it shall be replaced meeting the requirements stated in the Standard Specifications and these special provisions at the Contractor's cost.

D. Equipment Orders

The Contractor shall furnish all equipment and materials specified in plans and these special provisions that are not furnished by the County. All equipment shall be new and purchased by the Contractor for this project only.

The Contractor shall furnish the Engineer written statements from vendors stating that they have accepted the order for the said equipment within twenty-one (21) calendar days of the date that the County of Riverside Board of Supervisors awarded this contract. Delay in equipment delivering shall not be considered as justification for the suspension of the construction contract.

In addition to the liquidated damages set forth in Section 'Liquidated Damages' of these contract documents, the Contractor shall pay to the County of Riverside the sum of \$800 per day for each and every calendar day delay in receiving all of the below listed equipment, onto the job site or the contractors storage facility, and available for installation, within sixty (60) calendar days if standards/ posts, anchor bolts and IISNS mast arms were furnished by the County; otherwise, one hundred (100) calendar days of the contract award:

1. Traffic Signal Controller Assemblies
2. Service Equipment Enclosures
3. LED Modules
4. IISNS (Street Name Signs)

E. Equipment List and Drawings

Equipment list and drawings shall conform to the provisions in Section 86-1.04, "Equipment List and Drawings", of the Standard Specifications and these Special Provisions.

The Contractor shall furnish four complete cabinet wiring diagrams for each furnished controller assembly, battery backup system, video detection system, and emergency vehicle preemption system. The cabinet wiring diagram shall include an approximately 6 inches x 8 inches or larger schematic drawing of the project intersection (must be on an 8 1/2" x 11" paper), which shall include the following information, at a minimum:

1. North arrow
2. Street names
3. Pavement delineation and markings
4. Signal poles
5. Traffic signal heads with phase designations
6. Pedestrian signal heads with phase designations
7. Loop detectors with input file designations

F. Warranties, Guaranties, Instruction Sheets, and Manuals

Warranties, guaranties and instruction sheets shall conform to the provisions in Section 86-1.05, "Warranties, Guaranties and Instruction Sheets", of the Standard Specifications and these Special Provisions.

The LED modules supplied shall have five (5) years of manufacturer warranty.

The Battery Backup System (BBS) manufacturers shall provide a five (5) year warranty. The first three (3) years shall be termed the "Advanced Replacement Program". Under this program, the manufacturer will send out a replacement within two business days of the call notifying them of an issue. The replacement unit may be either a new unit or a re-manufactured unit that is up to the latest revision. The last two years of the warranty will be factory-repair warranty for parts and labor on the BBS.

The Video Detection System shall have three (3) years of manufacturer warranty. During the warranty period, technical support shall be available from the supplier via telephone within 4 hours of the time a call is made by a user, and this support shall be available from factory-certified personnel or factory-certified installers.

The contractor shall furnish the Engineer with the manufacturer's standard written warranty pertaining to defects in materials and workmanship for all equipment furnished by the Contractor.

The Contractor shall furnish two sets of user, operation, and maintenance manuals, written in English, on all equipments and components furnished for the signal and lighting systems.

G. Blank

H. Foundations

Foundations shall conform to the provisions in Section 51, "Concrete Structures", and Section 86-2.03, "Foundations", of the Standard Specifications and these Special Provisions.

Portland cement concrete shall conform to Section 90-10, "Minor Concrete", of the Standard Specifications and shall be Class 3 except pole foundations shall be Class 2.

The Contractor shall construct the controller cabinet foundation per Standard Plans.

All foundation concrete shall be vibrated to eliminate air pockets.

I. Standards, Steel Pedestals and Posts

Standards, steel pedestals, and posts shall conform to the provisions in Section 86-2.04, "Standards, Steel Pedestals and Posts", of the Standard Specifications and these Special Provisions.

Poles installed at the near-right approach of each intersection shall be banded for the emergency installation of stop signs. Banding shall conform to the strap and saddle method per Standard Plan RS4.

Type 1A standards shall be spun aluminum unless shown otherwise on the plans.

Signal mast arms shall be installed in accordance with the "Signal Arm Connection Details" of the Standard Plans unless specified otherwise on the plans.

Internally Illuminated Street name sign (IISNS) mast arm shall be 10 foot long galvanized steel mast arm with four (4) mounting taps constructed to prevent deformation or failure when subjected to 100 mph wind loads. IISNS mast arm shall extend from the shaft of the pole above and parallel to the signal mast arm in accordance with County Standard No. 1200. A set-bolt /set-screw shall be used to assure the mast arm will not change position after it is installed and aligned.

If required by the serving electric utility, and confirmed by the Engineer, State Certified Electric Workers shall be utilized for the installation of standards, steel pedestals, and posts in accordance with State of California High Voltage Safety Orders.

J. Conduits

Conduit shall conform to the provisions in Section 86-2.05, "Conduit", of the Standard Specifications and these Special Provisions.

Conduits shall be Type 3, Schedule 80 Polyvinyl Chloride (PVC) conforming to requirements in UL Publication 651 for Rigid Non-Metallic Conduit, for underground installation only.

Conduit depth shall not exceed 60 inches below finish grade.

Conduit size shall be 2 inches minimum unless otherwise specified on the plans or in the Special Provisions. New conduit shall not pass through foundations or standards.

All conduit bends shall be factory bends. Conduit bend radius for signal interconnect conduits shall be 3 feet minimum.

A pull rope and a bare #12 AWG wire shall be installed in conduits intended for future use.

Bell bushings are required for all conduit ends. After conductors have been installed, the ends of conduits terminating in pull boxes and controller cabinets shall be sealed with sealing compound approved by the Engineer.

Trenching Installation

The Contractor may request permission, on a case by case basis, to install conduit by trenching where conduit cannot be installed by jacking or drilling as provided in Section 86-2.05C, "Installation", of

the Standard Specifications. Jacking/Drilling shall be attempted a minimum of three times prior to requesting trenching installation.

If ordered by the Engineer, all pavements shall be cut to a depth of 3 inches with an abrasive type saw or with a rock cutting excavator specifically designed for this purpose. Cuts shall be neat and true with no shatter surface outside the removal area.

Trench shall be 2 inches wider than the outside diameter of the conduit being installed however not exceeding 6 inches in total width. Conduit depth shall be at a minimum of 30 inches below finished grade, with a minimum of 26 inches cover over the conduit.

The conduit shall be placed in the bottom of the trench and the trench shall be backfilled with two-sack slurry to finish grade. Prior to final paving, the slurry backfill shall be excavated to a depth of 0.30 feet below the final pavement surface.

If so directed by the Engineer, the two-sack slurry backfill shall be installed to a depth of 0.30 feet below the final pavement surface. The slurry shall be allowed to cure a minimum of two days prior to final paving with a commercial Type A ½", PG 64-10 asphalt concrete,

Prior to paving, the contractor shall grind the existing pavement a minimum of 0.10 feet deep at a width of 3 feet minimum, centered along the full length of the trench.

K. Pull Boxes

Pull boxes shall conform to the provisions in Section 86-2.06, "Pull Boxes", of the Standard Specifications and these Special Provisions.

Traffic pull boxes shall conform to the provisions in Section 86-2.07, "Traffic Pull Boxes", of the Standard Specifications and these Special Provisions.

Pull boxes shall have a "Fibrelyte" cover and bolt down design. Cover shall have a non-skid surface.

Pull box covers shall be marked in accordance with Standard Plans ES-8. Pull box covers shall not be marked "Caltrans" except for projects on State of California right of way.

Pull boxes shall be placed with their tops flush with surrounding finish grade or as directed by the Engineer.

Pull boxes shall be installed behind the curb or as shown on the plans and shall be spaced at no more than 500 feet intervals. The exact locations shall be determined by the Engineer.

Pull boxes installed in unimproved areas, locations not protected by concrete curb and gutter, shall be traffic bearing pull box and marked with Type L markers.

L. Conductors and Wiring

Conductors shall conform to the provisions in Section 86-2.08, "Conductors", of the Standard Specifications and these Special Provisions.

Multiple circuit conductors shall conform to the provisions in Section 86-2.08B, "Multiple Circuit Conductors", of the Standard Specifications and these Special Provisions.

Signal cable conductors shall conform to the provisions in Section 86-2.08D, "Signal Cable", of the Standard Specifications and these Special Provisions.

Wiring shall conform to the provisions in Section 86-2.09, "Wiring", of the Standard Specifications and these Special Provisions.

Signal cable shall be installed continuously without splicing from the controller cabinet to each traffic signal pole. Traffic signal conductors, multiple circuit conductors, and signal cable conductors shall not be spliced unless shown otherwise on the plans.

Where splice is required, Type C or Type T splice shall be used and insulated with "Method B" as shown in the Standard Plans, ES-13A.

Minimum luminaire wiring shall be No. 10 AWG, including wiring within poles and mast arms.

Specific cabling and wiring requirements for various systems or components shall be in accordance with the Special Provisions entitled to each herein.

M. Bonding and Grounding

Bonding and grounding shall conform to the provisions in Section 86-2.10, "Bonding and Grounding", of the Standard Specifications and these Special Provisions.

Grounding jumper shall be attached by a 3/16 inch or larger brass bolt in the signal standard or controller pedestal and shall be run to the conduit, ground rod or bonding wire in the adjacent pull box.

Grounding jumper shall be visible after cap has been poured on foundation.

For equipment grounding jumper a No. 8 bare copper wire shall run continuously in all circuits with the exception of conduits that contain only signal interconnect cable and/or loop detector cable and then a No. 12 bare copper wire shall run continuously in the circuit.

N. Service

Service shall conform to the provisions in Section 86-2.11, "Service", of the Standard Specifications and these Special Provisions.

Service equipment enclosure shall be Type III-CF, as shown on the Standard Plans, ES-2F, and shall conform to the following:

1. 120 / 240 volt, 2 meter service unless otherwise shown on the plans.
2. Circuit breakers required:
 - 2 - 100 Amp 2 pole (signal main and lighting main)
 - 1 - 30 Amp 1 pole (luminaires)
 - 1 - 20 Amp 1 pole (illuminated street name signs)
 - 1 - 30 Amp 1 pole (signals)
 - 1 - 15 Amp 1 pole (luminaire photoelectric control)
 - 1 - 15 Amp 1 pole (street name sign photoelectric control)
 - 1 - 15 Amp 1 pole (for video detection cameras)
 - 1 - 20 Amp 1 pole (for each beacon, if applicable)
3. Cabinet shall be fabricated from aluminum sheeting and finish shall be anodic coating in accordance with Section 86-3.04A "Cabinet Construction".
4. Circuit breakers shall be marked with identifying labels for each circuit breaker.

Type V photoelectric control contactor and test switch assembly shall be installed in the service cabinet. Photoelectric control contactors shall be as follows:

1. Luminaires - 60 Amp electrically held contact
2. Street name signs - 30 Amp electrically held contact

A GFCI outlet shall be installed on the interior side of service cabinet door and an eight (8) position terminal strip for termination of Video Cameras.

Photo Electric Control assembly shall be installed within the circuit breaker compartment of the service equipment enclosure, and accessible to the County after installation of electrical meters.

Direct burial service conductors shall not be approved.

The Contractor shall be responsible for contacting the power company, arranging and providing for the electrical service connection, and ensuring that adequate notice is provided to the serving electric company in advance of need. *The County of Riverside will pay all electric company fees required.*

The service equipment enclosure shall be separated from the controller by a minimum of 15 feet, and separated from all utility poles by a minimum of 10 feet, unless otherwise directed by the Engineer.

Service Identification

The service equipment enclosure shall provide the address of the intersection as shown on the approved plan. Address location shall be on the front upper panel. The meters shall also be labeled "LS3" (lighting meter) and "TC1" (signal meter) by lettering applied to the exterior of the enclosure in accordance with these special provisions, or as directed by the Engineer.

Lettering markings shall be black in color, with a two-inch minimum size in block letter form. Markings shall be applied to a brushed aluminum, stainless steel, or other non-corroding metallic plate, as approved by the Engineer. Plate shall be white in color. All paint and lettering markings

shall conform in all respects to Federal Specification TT-E-489, latest revision, Class A, Air Drying. Said plate shall be affixed in a permanent manner by riveting or with stainless steel bolts and nuts. Bolts shall be peened after tightening. All materials used for affixing address plate shall be non-corroding. All alternate materials and methods must be approved by the Engineer prior to implementation.

O. Testing

Testing and Field Testing shall conform to the provisions in Section 86-2.14, "Testing", of the Standard Specifications and these Special Provisions.

Specific testing requirements for various systems and components shall be in accordance with the Special Provisions entitled to each herein.

The complete controller assembly and Battery Backup System shall be delivered to the following location or location as directed by the Engineer for testing:

Traffic Signal Shop
Riverside County Transportation Department
McKenzie Highway Operations Center
2950 Washington Street
Riverside, California 92504
Traffic Signal Supervisor: Delaney Davesan
Telephone (951) 955-6894

The Contractor shall allow a minimum of 15 working days for operational testing and adjustment. An additional 15 working days period shall be allowed for retesting should the equipment fail.

The conflict monitor unit shall be tested in the field before signal turn on.

P. Controller Assembly

Controller assembly shall conform to the provisions in Section 86-3, "Controller Assemblies", of the Standard Specifications and these Special Provisions.

Controller assembly shall be Model 170 controller assembly consisting of the additional features:

1. Model 332A controller cabinet:
 - Anodic coating for both interior and exterior finish
 - A Corbin No. 2 door lock
2. An interior fluorescent lamp with an on/off switch and a door switch that will automatically turn on the lamp when cabinet door is opened.

3. A interior thermostatically controlled, 24 volt electric fan with ball or roller bearing that has capacity rating of 100 cubic feet per minute minimum.
4. Rack mounted push buttons for manual actuation of the following:
 - 8 vehicular phases,
 - 4 pedestrian phases,
 - 4 Emergency Vehicle Preemption (EVP) phases; and,
 - 2 Railroad preemption phases.
5. Model 170E local controller unit:
 - Dual Asynchronous Communications Interface Adaptor (ACIA) capability. ACIA shall be integral to the controller unit. Horizontal printed circuit board controllers will not be accepted.
 - A Model 412F Program Module with 32K 27256 EPROM, 16K RAM, and 8K zero power RAM (memory method two, memory select four).
 - Bitrans Systems, Inc. 233RV2.5 or latest version firmware, test program and a loopback cable.
6. If required per plan or special provisions, a Model 170E field master controller unit mounted above the local controller unit with the following features:
 - Same as 170E local controller except the firmware shall be Bitrans Systems, Inc. No. 245 FM.
7. A pullout shelf/drawer assembly made of aluminum with telescoping drawer guides for full extension installed below the local controller unit. The top shall have a non-slip plastic laminate permanently attached. The non-slip laminate shall not be attached with silicon adhesive.
8. Load Switches:

Switching circuit shall be contained in a replacement module (cube type) sealed in epoxy and rated at 15 amperes load (25 Amp triac). Pin 11 on all load switch sockets shall be wired to AC. Input and output indicators shall be installed on all load switches.

All load switch sockets shall have individual wire terminals. Printed circuit boards will not be allowed.
9. Flasher units:

Switching circuit shall be contained in a replacement module (cube type) sealed in epoxy and rated at 15 amperes load (25 Amps triac).
10. Conflict monitor shall be EDI Model 2010ECL or equivalent with a red monitor assembly circuit board and capable of monitoring green, amber and red indications.
11. Loop detector sensor unit shall be Model 222:
 - Detector unit shall have delay timers adjustable from zero to a minimum of 30 seconds and extension timers adjustable from zero to a minimum of 7 seconds.

- Delay timers shall delay calls only during display of the associated red or yellow indications. If a vehicle departs the area of detection prior to expiration of the assigned delay period, the timer shall reset and no call shall be placed upon the controller. During display of the associated green indication, detectors shall operate in the present mode and calls shall not be delayed.

12. Power Distribution Assembly shall be Model PDA-2.

13. A twelve-position interconnect terminal strip.

The contractor shall furnish the following spare equipments / components:

Description	Model	Quantity
Cabinet	332	0
Controller Unit (local)	170E	0
Controller Unit (master)	170E	0
Switch Pack	200	0
Flasher Unit	204	0
Conflict Monitor Unit	2010	0
2-Channel Loop Detector	222	0
2-Channel DC Isolator	242	0
Modem Module	400	0
Program Module	412F	0

Spare equipments or components shall be delivered to the following location or as directed by the Engineer:

Traffic Signal Shop
 Riverside County Transportation Department
 McKenzie Highway Operations Center
 2950 Washington Street
 Riverside, California 92504
 Traffic Signal Supervisor: Delaney Davesan
 Telephone (951) 955-6894

The controller unit and controller cabinet shall be manufactured and furnished by the same manufacturer to form a complete functional controller system capable of providing the traffic signal operation specified. All traffic control equipment to be furnished shall be currently acceptable to Caltrans laboratory in Sacramento, CA, and listed on the Department of Transportation Qualified Products List.

The controller unit and controller cabinet manufacturer or supplier shall perform operational and functional testing of the supplied controller assembly and additional supplied equipment in accordance with the State of California Department of Transportation's Transportation Electrical

Equipment specifications (TEES), and a Certificate of Compliance shall be issued for each successfully tested controller assembly and additional supplied equipment.

The Contractor shall modify traffic signal controller assembly if necessary and provide any necessary auxiliary equipment and cabling to achieve the intended traffic signal operation as shown on the plans. The Contractor shall make all field wiring connections to the terminal blocks inside the controller cabinet.

The Contractor shall have a technician who is qualified to work on the controller assembly from the controller manufacturer or their representative to install the program module and program the signal controller in accordance with County provided signal timing sheets, and to be present when the equipment is turned on.

Q. Vehicle Signal Assemblies

Vehicle signal assemblies and auxiliary equipment shall conform to the provisions in Section 86-4.01 "Vehicle Signal Faces", Section 86-4.01B (1), "Metal Signal Sections", Section 86-4.01D "Visors", Section 86-4.04, "Backplates", and Section 86-4.08 "Signal Mounting Assemblies" of the Standard Specifications and these Special Provisions.

Programmed visibility traffic signal heads shall conform to the provisions in Section 86-4.05, "Programmed Visibility Vehicle Signal Faces", of the Standard Specifications and these Special Provisions.

Signal section housing, backplates and visors shall be metal type. Backplates shall be louvered. Visors shall be the "tunnel" type, unless otherwise specified. Top opening of signal heads shall be sealed with neoprene gaskets.

Signal Mounting Assemblies, Backplates, Signal Sections and Housings shall be made from the same manufacturer and the section assemblies shall be uniform in appearance and alignment.

All vehicle signal indications shall be 12-inch diameter Light Emitting Diode (LED) modules in accordance with the following:

1. All circular LED modules shall comply with Institute of Transportation Engineers (ITE) Vehicle Traffic Control Signal Heads (VETCH) - LED Circular Supplement, Adopted June 27, 2005.
2. All arrow LED modules shall comply with ITE VETCH - LED Vehicle Arrow Traffic Signal Supplement, Adopted July 1, 2007.
3. All modules shall fit in existing signal housings without the use of special tools.
4. All modules shall be certified in the Intertek LED Traffic Signal Modules Certification Program and be labeled with the ETL Verified Label as follows:



**LED Traffic Signal Modules
Certification Program**

XXXXX

**Intertek Testing Services, N.A., Inc.
Cortland, New York 13045**

5. Luminous intensity requirements of the VTCSH must be met across the entire temperature range from -40°C to $+74^{\circ}\text{C}$, (-40°F to $+165^{\circ}\text{F}$).
6. The following cable colors shall be used for the AC power leads on all modules: white for common, red for the red module line, yellow for the yellow module line, and brown for the green module line.
7. The AC power leads shall exit the module via a rubber grommet strain relief, and shall be terminated with quick connect terminals with spade tab adapters. The leads shall be separate at the point at which they leave the module.
8. All external wiring used in the module shall be anti-capillary type cable to prevent the wicking of moisture to the interior of the module.
9. All power supplies shall be coated for additional moisture and thermal protection.
10. The module shall have an incandescent, non-pixelated appearance when illuminated.
11. Nominal power usage is measured at 25°C , 120 VAC. For the 8 inch modules, it shall not exceed 8 watts for Red, 8 watts for Yellow, and 8 watts for Green modules. For the 12 inch modules, it shall not exceed 10 watts for Red, 19 watts for Yellow, and 11 watts for Green modules. For the arrows, it shall not exceed 6 watts for any color.
12. All modules shall use LEDs that have been manufactured with materials that have industry acceptance as being suitable for uses in outdoor applications. At no time is the use of LEDs that utilize AlGaAs technology acceptable.
13. The external lens shall have a smooth outer surface to prevent the buildup of dirt and dust and shall be designed to minimize the potential for sun phantom signals.
14. The circular LED module lens material must be tinted. A tinted transparent film or coating is not permitted.
15. A module shall be sealed against dust and moisture intrusion, including rain and blowing rain per Mil-Std-810F Method 506.4, Procedure 1.
16. Arrow modules shall be clearly marked with the phrase "Suitable for mounting in any orientation".

17. Modules shall be repaired or replaced if the module fails to function as intended due to workmanship or material defects within warranty period.
18. Modules shall be repaired or replaced if the module exhibit luminous intensities less than the minimum specified values within 60 months of the date of delivery.
19. The Manufacturer shall clearly disclose the country in which the factory of module origin is located, the name of the company or organization that owns the factory including all of its parent companies and/or organizations, and their respective country of corporate citizenship.

R. Pedestrian Signal Assemblies

Pedestrian signals shall conform to the provisions in Section 86-4.06, "Pedestrian Signal Faces", of the Standard Specifications and these Special Provisions.

Pedestrian signals shall be equipped with countdown pedestrian module unless otherwise indicated on the plans.

Pedestrian signals shall be provided with a polycarbonate egg crate or Z-crate screen.

Pedestrian Signal Mounting Assemblies and Pedestrian Signal Housings shall be made from the same manufacturer and the section assemblies shall be uniform in appearance and alignment.

Pedestrian signal indications shall utilize light emitting diode signal modules in accordance to the following:

1. It shall comply with ITE specification: Pedestrian Traffic Control Signal Indications (PTCSI) Part 2: LED Pedestrian Traffic Signal Modules, Adopted March 19, 2004.
2. All modules shall fit in existing signal housings without the use of special tools.
3. All modules shall be certified in the Intertek LED Traffic Signal Modules Certification Program and be labeled with the ETL Verified Label as follows:

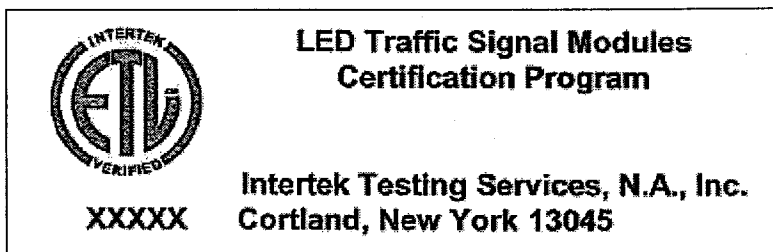

The PTCSI does not cover the countdown features of countdown pedestrian signal LED modules. The countdown features shall incorporate the following:

1. Fully compliant to NEMA TS-1, NEMA TS-2, Type 170, and Type 2070 traffic signal controller specifications.
2. The countdown portion of the pedestrian (ped) module shall have a high off-state input impedance so as not to provide a load indication to conflict monitors and interfere with the monitoring of the pedestrian signal. The input impedance of the countdown circuitry shall maintain a voltage reading above 25 VAC to the conflict monitor for up to four units connected on the same channel.
3. The countdown drive circuitry shall not be damaged when subjected to defective load switches providing a half wave signal input.
4. The countdown ped module shall have an internal conflict monitor circuit preventing any possible conflicts between the Hand, Person, and Countdown signal indications. It shall be impossible for the display to countdown during a solid Hand indication.
5. Per CA MUTCD Manual 2006 edition, section 4E.07: "If used, the countdown displays shall display the number of seconds remaining until the termination of the pedestrian change interval. Countdown displays shall not be used during the walk interval or during the yellow change interval of a concurrent vehicular phase".
6. The countdown ped module shall have a micro-processor capable of recording its own time when connected to a traffic controller. It shall be capable of displaying the digits 0 through 99.
7. When power is first applied or restored to the ped module, the countdown display will be blank during the initial cycle while it records the countdown time using the walk (person) and don't walk (flashing hand) signal indications. The normal hand and person icons shall be displayed during this cycle.
8. The countdown ped module shall continuously monitor the traffic controller for any changes to the pedestrian phase time and re-program itself automatically if needed.
9. The countdown ped module shall register the time for the walk and clearance intervals individually and shall begin counting down at the beginning of the pedestrian clearance interval. The digits shall not flash during the countdown.
10. When the flashing hand becomes solid, the ped module shall display 0 for one second and then blank-out. The display shall remain dark until the beginning of the next countdown.
11. In the event of a pre-emption, the countdown ped module shall skip the remaining time, reach 0 at the same time as the flashing Hand becomes solid, and remain dark until the next cycle.
12. In the cycle following preemption call, the signal shall display the correct time and not be affected by the reduced previous cycle. The countdown shall remain synchronized with the signal indications and always reach 0 at the same time as the flashing Hand becomes solid.

13. If a pedestrian button is activated during the clearance interval, some controllers can change to a second walk cycle without a don't walk phase. The countdown module shall also be capable of consecutive walk cycles. The display digits will be blank during the second walk and countdown properly during the second flashing hand.
14. The countdown ped module shall not display an erroneous or conflicting time when subjected to defective load switches. Should there be a short power interruption during the ped clearance interval or if voltage is applied to both the hand and person simultaneously the display will go to "0" then blank.
15. The countdown ped module shall have accessible dip-switches for the user selectable options. The unit shall have a removable plug on the rear allowing easy access to control the user selectable functions. The countdown is disabled when all the switches are in the "ON" position. The unit shall be shipped from the factory with the specified default setting.
16. Switch 1 – Blank Cycle Following a Timing Change – Factory default is "OFF". When this switch is "OFF" the unit will allow the time to be displayed normally during the cycle following a truncated timing such as a preemption call. The countdown shall be capable of displaying the correct time and not affected by the previous reduced cycle. The unit will require 2 consecutive reduced cycles of identical value to validate and record a new time setting. If the timing is extended, the unit will record it immediately. In the "ON" position when a change in timing is detected the unit will blank out during the following cycle while the new cycle time is measured and recorded if confirmed.
17. Switch 2 – Disables Auto-sync Mode- Factory default setting is "OFF". When this switch is in the "OFF" position the auto-sync is enabled. When the clearance interval begins and the initial flash of the hand is not in sync with the walk signal the unit will measure the offset and reduce the duration of the first second by the value of the offset. This will ensure the countdown reached zero at the same time as the flashing hand becomes solid. In the "ON" position there is no time correction when the flashing hand is in offset with the walk signal. The duration of the first second will not be reduced and the hand will appear solid shortly before the countdown reaches zero.
18. Switch 3 – Countdown Starts with Flashing Hand Signal – Factory default setting is "ON". When this switch is "ON" the countdown begins when the hand signal is turned on. With this switch "ON" and the auto-sync mode enabled a short power interruption will have no effect on the countdown display. With switch 3 in the "OFF" position the countdown begins when the walk signal is turned off. This eliminates the effect of an offset hand signal. When switch 3 is in the "OFF" position the auto-sync switch 2 has no effect on the countdown. In this mode if the power to the walk signal is interrupted, the unit will interpret this as the start of the clearance interval and will display the countdown time for 2 seconds before the operation is cancelled. The countdown will resume with the normal ending of the walk signal.
19. Switch 4 – Stores Time Value in Memory, Immediate. Restart. - Factory default setting is "OFF". When this switch is in the "OFF" position and power is removed from the unit, the time value stored in the unit is erased. The unit will need to run a dark cycle before it can display the countdown again. In the "ON" position the countdown timing is stored in memory. Following a power interruption, the unit will restart with the stored value and not

remain dark during the learning cycle. If the value is different after restart, it will be recorded and displayed correctly at the following cycle.

20. Switch 5 – All LEDs “ON”, Test Mode – Factory default setting is “OFF”. With this switch in the “ON” position all LEDs are turned on simultaneously. With both switches 4 and 5 in the “ON” position the LED test mode will also scan the 7 individual segments of both digits.
21. The countdown shall be disabled when all switches are placed in the “ON” position.
22. Nominal power usage for Ped Modules at 25°C (77°F), 120 VAC input shall not exceed the values shown in Table 1.

Table 1 -- Nominal Power of Pedestrian Signals

Size	Description	Wattage @ 25°C		
		Hand	Person	Countdown ¹
16"x18"	Side by Side Hand & Person	8	7	N/A
16"x18"	Hand & Person Overlay with Countdown	9	7	5

¹ Wattage for the countdown is measured when the digits 18 are displayed.

23. All wiring shall meet the requirements of Section 13.02 of the VTCSH standard. Secured, color coded, 600V, 18 AWG jacketed wires, 1 meter (39 in) in length, conforming to the NFPA 70, National Electrical Code, and rated for service at +105°C, shall be provided.
24. The following color scheme shall be used for the ped module’s AC power leads: Orange for the upraised hand, Blue for the walking person, and White for common. The countdown portion of the LED ped module shall be internally wired to the hand and walking person power.
25. The AC power leads shall exit the ped module via a rubber grommited strain relief, and shall be terminated with insulated female quick connect terminals with spade / tab adapters. The leads shall be separate at the point at which they leave the ped module.
26. All external wiring utilized in the ped modules shall be anti-capillary type wire to prevent the wicking of moisture to the interior of the ped module.
27. The Hand and Person Icons shall utilize separate power supplies. On countdown products, the countdown ped module must have its own power supply but may take the incoming AC power from the hand / person AC signal lines. All power supplies shall be located inside the ped module.
28. All power supplies shall be conformally coated for additional protection.

29. Off State Voltage Decay: When the hand or person icon is switched from the On state to the Off state the terminal voltage shall decay to a value less than 10 VAC RMS in less than 100 milliseconds when driven by a maximum allowed load switch leakage current of 10 milliamps peak (7.1 milliamps AC).
30. For a minimum period of 60 months, measured at 80 to 135 VAC RMS and over the ambient temperatures of -40°C to +74°C (-40°F to +165°F), the minimum maintained luminance values for the ped modules, when measured normal to the plane of the icon surface, shall not be less than:
- Walking Person, White: 2,200 cd/m²
 - Upraised Hand, Portland Orange: 1,400 cd/m²
 - Countdown Digits, Portland Orange: 1,400 cd/m²
31. The external lens shall have a textured outer surface to reduce glare.
32. Icons that are printed on the lens shall be on the interior surfaces in order to prevent scratching and abrasion to the icons.
33. All icons and numbers shall have a uniform incandescent non-pixelated appearance.
34. All exposed components of a ped module shall be suitable for prolonged exposure to the environment, without appreciable degradation that would interfere with function or appearance. As a minimum, selected materials shall be rated for service for a period of a minimum of 60 months in a south-facing Arizona Desert installation.
35. All LEDs used to illuminate the ped module shall use material that has industry acceptance for use in outdoor applications. At no time is the use of LEDs that utilize AlGaAs technology acceptable.
36. The countdown display shall consist of two 7 segment digits as shown below. All countdown display digits shall be 9 inches in height for use in all size crosswalks in compliance with MUTCD recommendations.

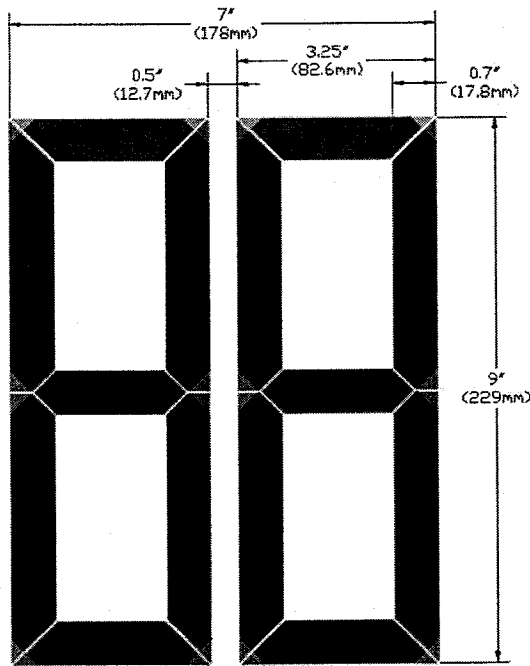

Figure 2: Countdown Display

37. Ped modules shall be repaired or replaced if the ped module fails to function as intended due to workmanship or material defects within warranty period.
38. Ped modules shall be repaired or replaced if the ped module exhibit luminous intensities less than the minimum specified values within 60 months of the date of delivery.
39. The manufacturer shall clearly disclose the country in which the factory of ped module origin is located, the name of the company or organization that owns the factory including all of its parent companies and organizations, and their respective country of corporate citizenship.

S. Pedestrian, Bicycle and Equestrian Push Buttons

Pedestrian, bicycle, and equestrian push buttons shall conform to the provisions in Section 86-5.02, "Pedestrian Push Buttons", of the Standard Specifications and these Special Provisions.

Push button assembly shall be Type B per Standard Plans ES-5C.

Push button housing shall be die-cast or permanent mold cast aluminum powder coated frame with stainless steel inserts and sign screws.

Push button sign shall be white powder coat base with black heat cured ink. Right and left arrow signs shall be doubled sided.

Push button shall be Polara Engineering, Inc. model BDLM2-Y, or approved equal.

Push button shall utilize solid state Piezo switch technology, pressure activated, two-tone audible, visual LED confirmation of actuation and shall be ADA compliant.

The equestrian push buttons (EPB) shall be installed at 6 feet above finish grade or as directed by the Engineer. The Engineer shall approve the EPB placement on each pole prior to installation.

T. Detectors

Detectors shall conform to the provisions in Section 86-5, "Detectors", of the Standard Specifications and these Special Provisions.

Delay timers shall delay calls only during display of the associated red or yellow indications. If a vehicle departs the area of detection prior to expiration of the assigned delay period, the timer shall reset and no call shall be placed upon the controller. During display of the associated green indication, detectors shall operate in the present mode and calls shall not be delayed.

Inductive Loops

Detector loops' configuration shall be Type E unless otherwise shown on the construction plan, in the Special Provisions or as directed by the Engineer.

Limit Line detector loop configuration shall be modified Type E with diagonal saw cuts and wire winding conforming to Type D loop configuration.

Detector loops' wire shall be Type 2.

Detector loops' lead-in cable shall be Type B.

Detector loops' curb terminations shall be Type A in accordance with Standard Plans ES-5D.

Loop sealant shall be the Hot-Melt Rubberized Asphalt sealant type, unless otherwise directed by the Engineer. Loop conductors and sealant shall be installed on the same day the loop slots are cut.

All detector loops shall be tested sequentially by the following methods:

- impedance (measured by megaohms)
- resistance (measured by ohms)
- inductance (measured in microhenries)

Video Detection

The contractor shall furnish and install video detection cameras (VDC), video detection processors (VDP), extension modules (EM), a pointing device, a drawer mounted 17 inch LCD monitor, surge suppressors, and all necessary cabling and auxiliary equipment to make the video detection systems fully functional for the intended operation. The Contractor shall furnish a spare VDC, a spare EM, and a spare VDP to the Engineer.

The video detection camera shall attach to the top of luminaire mast arm using mounting bracket provided by manufacturer, or the backside of signal mast arm using Pelco Astrobrac with 6' extension or approved equal. The Engineer shall approve the final camera placements.

The video detection systems shall be installed by supplier factory certified installers and as recommended by the supplier and documented in installation materials provided by the supplier. Proof of factory certification shall be provided.

Video Detection Zones:

Placement of detection zones shall be done by using the supplied pointing device connected to the VDP to draw the detection zones on the video image from the video camera displayed on a video monitor using the menu and graphical interface built into the VDP. The menu shall facilitate placement of detection zones and setting of zone parameters or to view system parameters.

Detection zone setup shall not require site-specific information such as latitude, longitude, date and time to be entered into the system. No separate computer shall be required to program the detection zones.

Each detection zone shall be user definable in size and shape to suit the site and the desired vehicle detection region. A detection zone shall be approximately the width and length of one car.

A single detection zone shall be able to replace multiple inductive loops and the detection zones shall be OR'ed as the default or may be AND'ed together to indicate vehicle presence on a single phase of traffic movement.

When a vehicle is detected crossing a detection zone, the corners of the detection zone shall flash on the video overlay display screen to confirm the detection of the vehicle.

Distance between the detection zone placement and the camera shall not be more than a distance of ten times the mounting height of the camera.

Functional Capabilities:

System must have a single point access to multiple rack-mounted video detection units. The access device shall provide interface capabilities to enable multiple rack-mounted video detection processors to be locally and remotely accessed from a single point via one set of user interface devices.

The video detection processor (VDP) shall process video from one or two sources. The video input to the VDP shall be in NTSC or PAL composite video format and shall be digitized and analyzed in real time. Dual video VDP's shall process images from both inputs simultaneously.

The camera shall be able to transmit the composite video signal, with minimal signal degradation, up to 1000 feet under ideal conditions.

The VDP shall have a nine-pin RS232 port that is multi-drop compatible for communications with an external computer. The VDP shall be able to accept new detector patterns from and send its detection patterns to an external computer through this RS-232 port. A Windows™ based software designed for local or remote connection for uploading and downloading data, and providing video capture, real-time detection indication and detection zone modification capability shall be provided with the system.

The extension module (EM) shall be available to avoid the need of rewiring the detector rack, by enabling the user to plug an extension module into the appropriate slot in the detector rack. The extension module shall be connected to the VDP by an 8-wire cable with modular connectors. VDP and EM communications shall be accommodated by methods using differential signals to reject electrically coupled noise. The extension module shall be available in both 2 and 4 channel configurations. EM configurations shall be programmable from the VDP.

The VDP shall provide a minimum of 24 channels of vehicle presence detection/detection zones per camera through a standard detector rack edge connector and one or more extension modules.

The VDP shall store up to three different detection zone patterns within the VDP memory. The VDP's memory shall be non-volatile to prevent data loss during power outages. The VDP shall continue to operate (e.g. detect vehicles) using the existing zone configurations even when the operator is defining/modifying a zone pattern. The new zone configuration shall not go into effect until the operator saves the configuration. Each configuration can be uniquely labeled for identification and the current configuration letter is displayed on the monitor. The selection of the detection zone pattern for current use shall be done through a local menu selection or remote computer via RS-232 port. It shall be possible to activate a detection zone pattern for a camera from VDP memory and have that detection zone pattern displayed within 1 second of activation.

The VDP shall provide dynamic zone reconfiguration (DZR) to enable normal detector operation of existing channels except the one where a zone is being added or modified during the setup process. The VDP shall output a constant call on any detection channel corresponding to a zone being modified.

The VDP shall detect vehicles in real time as they travel across each detector zone.

The VDP shall output a constant call for each enabled detector output channel if a loss of video signal occurs. The VDP shall output a constant call during the background learning period.

The VDP shall be capable of detecting a low-visibility condition automatically, such as fog, and place all defined detection zones in a constant call mode. The VDP shall automatically revert to normal detection mode when the low-visibility condition no longer exists. A user-selected output shall be active during the low-visibility condition that can be used to modify the controller operation if connected to the appropriate controller input modifier(s).

Detection shall be at least 98% accurate in good weather conditions and at least 96% accurate under adverse weather conditions (rain, snow, or fog). Detection accuracy is dependent upon site geometry; camera placement, camera quality and detection zone location, and these accuracy levels do not include allowances for occlusion or poor video due to camera location or quality.

Detection zone outputs shall be configurable to allow the selection of presence, pulse, extend, and delay outputs. Timing parameters of pulse, extend, and delay outputs shall be user definable between 0.1 to 25.0 seconds.

Up to six detection zones shall be capable to count the number of vehicles detected. The count value shall be internally stored for later retrieval through the RS-232 port. The data collection interval shall be user definable in periods of 5, 15, 30 or 60 minutes.

Video Detection Processor (VDP) & Extension Module (EM) Hardware:

The VDP and EM shall be specifically designed to mount in a standard NEMA TS-1, TS-2, 2070 ATC, 170 type detector rack, using the edge connector to obtain power and provide contact closure outputs. No adapters shall be required to mount the VDP or EM in a standard detector rack. Detector rack rewiring shall not be required or shall be minimized.

The VDP and EM shall operate in a temperature range from -34°C to +74°C and a humidity range from 0% RH to 95% RH, non-condensing.

The VDP and EM shall be powered by 12 or 24 volts DC. These modules shall automatically compensate for the different input voltages.

VDP power consumption shall not exceed 300 milliamps at 24 VDC. The EM power consumption shall not exceed 120 milliamps at 24 VDC.

The VDP shall include an RS232 port for serial communications with a remote computer. The VDP RS232 port shall be multi-drop compatible. This port shall be a 9-pin "D" subminiature connector on the front of the VDP.

The VDP shall utilize flash memory technology to enable the loading of modified or enhanced software through the RS232 port without modifying the VDP hardware.

The VDP and EM shall include detector output pin out compatibility with industry standard detector racks.

The front of the VDP shall include detection indications, such as LED's, for each channel of detection that display detector outputs in real time when the system is operational.

The front of the VDP shall include one or two BNC video input connection suitable for RS170 video inputs as required. The video input shall include a switch selectable 75-ohm or high impedance termination to allow camera video to be routed to other devices, as well as input to the VDP for vehicle detection. Video must be inputted via a BNC connector on the

front face of the processor. RCA type connectors/jacks for video input are not allowed. Video shall not be routed via the edge connectors of the processor.

The front of the VDP shall include one BNC video output providing real time video output that can be routed to other devices. A RCA type connector/jack for video output is not allowed.

The front panel of the VDP and EM shall have a detector test switch to allow the user to place calls on each channel. The test switch shall be able to place either a constant call or a momentary call depending on the position of the switch.

Video Detection Camera:

The VDC used for traffic detection shall be furnished by the VDP supplier and shall be qualified by the supplier to ensure proper system operation.

The camera shall produce a useable video image of the bodies of vehicles under all roadway lighting conditions, regardless of time of day. The minimum range of scene luminance over which the camera shall produce a useable video image shall be the minimum range from nighttime to daytime, but not less than the range 0.1 lux to 10,000 lux.

The camera shall use a CCD sensing element and shall output monochrome video with resolution of not less than 380 lines horizontal.

The camera shall include an electronic shutter control based upon average scene luminance and shall be equipped with a factory adjusted manual iris. Auto-iris lenses are not allowed.

The camera shall include a variable focal length lens with variable focus that can be adjusted, without opening up the camera housing, to suit the site geometry by means of a portable interface device designed for that purpose and manufactured by the detection system supplier. The horizontal field of view shall be adjustable from 8.1 to 45.9 degrees. A single camera configuration shall be used for all approaches in order to minimize the setup time and spares required by the user.

The camera electronics shall include Automatic Gain Control (AGC) to produce a satisfactory image at night or low light conditions.

The camera shall be housed in a weather-tight sealed enclosure. The housing shall be field rotatable to allow proper alignment between the camera and the traveled road surface.

The camera enclosure shall be equipped with a sunshield. The sunshield shall include a provision for water diversion to prevent water from flowing in the camera's field of view. The camera enclosure with sunshield shall be less than 153 mm diameter, less than 380-mm long, and shall weigh less than 2.7 kg when the camera and lens are mounted inside the enclosure.

The camera enclosure shall include a thermostatically controlled heater to assure proper operation of the lens shutter at low temperatures and prevent moisture condensation on the optical faceplate of the enclosure.

When mounted outdoors in the enclosure, the camera shall operate satisfactorily in a temperature range from -34 degree C to +60 degree C and a humidity range from 0% RH to 100% RH.

The camera shall be powered by 120-240 VAC 50/60 Hz. Power consumption shall be 15 watts or less under all conditions.

The camera enclosure shall be equipped with separate, weather-tight connections for power and setup video cables at the rear of the enclosure. These connections may also allow diagnostic testing and viewing of video at the camera while the camera is installed on a mast arm or pole using a lens adjustment module supplied by the VDP supplier. Video and power shall not be connected within the same connector.

The video signal output by the camera shall be black and white in RS170 or CCIR format.

The video signal shall be fully isolated from the camera enclosure and power cabling.

Cabling and Cable Connections:

Interface among the VDPs and EMS shall use RJ-45 interface connectors.

The coaxial cable to be used between the camera and the VDP in the traffic cabinet shall be Belden 8281. The coax cable shall be a continuous unbroken run from the camera to the VDP. This cable shall be suitable for installation in conduit or overhead with appropriate span wire. 75-ohm BNC plug connectors should be used at both the camera and cabinet ends. The coaxial cable, BNC connector, and crimping tool shall be approved by the supplier of the video detection system, and the manufacturer's instructions must be followed to ensure proper connection.

The power cabling shall be 16 AWG three conductor cable with a minimum outside diameter of 0.325 inch and a maximum diameter of 0.490 inch. The cabling shall comply with the National Electric Code, as well as local electrical codes. Cameras shall not acquire power from the luminaire.

All service cables shall run continuously into the service cabinet. A 1-amp Inline fuse shall be provided for each service cable and a minimum of 8-position terminal block shall be provided as directed by the Engineer inside the service cabinet.

Maintenance and Support:

The supplier shall maintain an adequate inventory of parts to support maintenance and repair of the system. These parts shall be available for delivery within 30 days of placement of an acceptable order at the supplier's then current pricing and terms of sale for said parts.

The supplier shall maintain an ongoing program of technical support for the access unit and video detection system. This technical support shall be available via telephone, or via personnel sent to the installation site upon placement of an acceptable order at the supplier's then current pricing and terms of sale for on-site technical support services.

Installation or training support shall be provided by factory-authorized representative.

U. Luminaries

Luminaires shall conform to the provisions in Section 86-6, "Lighting", of the Standard Specifications and these Special Provisions.

Luminaires shall be of the cutoff type and shall be 200 or 250 Watt High Pressure Sodium Vapor as shown on the plans. The fixtures shall be constructed with flat lenses, integral ballasts, and detachable power unit assemblies. The power unit assemblies shall contain the ballast, starter board, capacitors, and a heavy-duty terminal block.

Each luminaire shall be furnished without the photoelectric unit receptacle. If the luminaire housing is provided with a hole for the receptacle, the hole shall be closed in a weatherproof manner.

Each luminaire shall have a 5-amp inline fuse installed inside the standard's hand hole.

V. Sign Lighting Fixtures

Sign lighting fixtures shall conform to the provisions in Sections 86-6.06, "Sign Lighting Fixtures – Incandescent", of the Standard Specifications.

Sign lamp for Type 9 Standard shall be 36" LED type. Power consumption not to exceed 30W.

W. Internally Illuminated Street Name Sign

Internally illuminated street name signs (IISNS) shall conform to the provisions in Section 86-6.065, "Internally Illuminated Street Name Signs", of the Standard Specifications and these Special Provisions.

Sign panels shall be slide-mounted or rigid mounted in a frame with white translucent diamond grade reflective legend, symbol, arrows, and border on each face, the background shall be green. FHWA Series E 10" uppercase and 7.5" lowercase fonts.

If the 8' sign panel will not accommodate a long street name using FHWA Series E 10" uppercase and 7.5" lowercase fonts, then FHWA Series E 8" and 6" lowercase fonts can be used.

The sign fixture, panels, and mounting assemblies shall be designed and constructed to prevent deformation, warp or failure when subjected to 100 mph wind loads, as set forth in the latest AASHTO publication, "Standard Specifications for Structural Supports of Highway Signs, Luminaires, and Traffic Signals", and amendments thereto. The IISNS manufacturer shall submit a

certificate of compliance conforming to the provisions in Section 6-1.07, "Certificates of Compliance", with each lot of IISNSs delivered.

The IISNSs shall be attached to the 10 feet IISNS mast arm per County Standard No. 1200.

Support brackets shall be 3/8" X 1.5" or larger that can withstand 100 mph wind load.

Lighting fixture shall be LED type and conform to the following provisions:

LED Specification:

1. The LED Light System shall be an operational unit consists of LED module or modules and power supply or supplies.
2. The LED Light System shall fit within the existing 6 feet or 8 feet internally illuminated street name sign (IISNS) housing.
3. The LED Light system shall be UL certified, damp location rated and RoHS compliant.
4. The LED Light system's power consumption shall not exceed 60W for a 6 feet sign or 80W for an 8 feet sign.
5. The LED Light system shall not require the use of an additional or external diffuser to disperse the light.
6. The LED Light system manufacturer shall have been in business supplying LED products for signage or lighting at least 12 months (references required).
7. LED Light system shall meet the minimum criteria listed in the specification. All manufacturer documentation including specification and warranty for both LED modules and power supply shall be submitted and approved by the County prior to installation.

Power Supply

1. The power supply shall be Class 2.
2. The power supply shall provide efficiency greater than 87%.
3. The manufacturer shall warrant the power supply for a minimum of 60 months.

LED Modules

1. The LED correlated color temperature shall be 4100K or higher.
2. The LED shall have a minimum of 120-degree viewing angle.
3. The LED modules shall be available in single or double sided.
4. The average life of LEDs contained in the LED Module shall be rated for 50,000 hours or more.
5. The LED modules shall produce 4100 lumens minimum to the sign face of a 6' IISNS; and 5000 lumens minimum to the sign face of an 8' IISNS.
6. The manufacturer shall warrant the LED modules for a minimum of 48 months.

X. Photoelectric Controls

Photoelectric controls shall conform to the provisions in Section 86-6.07, "Photoelectric Controls", of the Standard Specifications and these Special Provisions.

Photoelectric controls shall be a dual Type V for luminaires and internally illuminated street name signs conforming to the County Road Improvement Standards No. 1207.

Photoelectric units shall be the delay type.

Y. Emergency Vehicle Preemption System

The Contractor shall furnish and install complete and functioning emergency vehicle preemption (EVP) system as intended per plans, the manufacturer, and these special provisions. The transmitting equipment is not included in this contract.

The EVP system shall consist of the following equipments or components:

- Optical detector for each approach, as shown on the plans
- Rack-mounted 2-channel phase selectors for 8-phase operation
- Detector cable

The Contractor shall furnish the following spare EVP equipments or components:

- One (1) rack-mounted 2-channel phase selector
- One (1) optical detector

The EVP system shall be designed to prevent simultaneous pre-emption by two or more emergency vehicles on separate approaches to the intersection.

The Engineer shall approve EVP sequence of operation prior to timing and turn-on of each respective traffic signal.

At locations where optical detectors are not to be installed, EVP cable shall be installed for future use. The following also apply:

1. EVP cable shall be installed, without splices, between the controller cabinet and each mast arm traffic signal pole.
2. EVP cable shall be connected to the EVP rack terminals within the controller cabinet.
3. Each mast arm EVP detector mounting shall be drilled and tapped in its ultimate location. In lieu of the detector, install approved water tight UL listed electrical box. EVP cable shall be installed to terminate within the mast arm mounted electrical box. Excess cable shall be coiled within the electrical box sufficient for future installation of the EVP system.

Optical Detector

The optical detector shall be mounted on the indicated signal mast arm per Riverside County Standard No. 1202.

Each optical detector shall be waterproof unit capable of receiving optical energy from a single direction. The reception angle for each optical detector unit shall be a minimum of eight (8) degrees in all directions about the aiming axis of the unit.

Internal circuitry shall be solid state and electrical power shall be provide by the associated discrimination module.

Each optical detector unit shall have a minimum of a ½ inch NPT opening used for mounting and for bringing the connecting cable into the terminal block located within the assembly. The housing shall be provided with weep holes to permit drainage of condensed moisture.

Each optical detector shall be installed, wired, and aimed as specified by the manufacturer.

Cable

Optical detector cable shall meet the requirements of IPCEA-S-61-402/NEMA WC 5, Section 7.4, 600 V Control cable, 75 degrees C, Type B, and the following:

1. The cable shall contain 3 conductors, each of which shall be AWG# 20 (7 x 28) stranded, tinned copper. Insulation of individual conductors shall be color-coded: 1-Yellow, 1-Orange, and 1-Blue.
2. The shield shall be either tinned copper braid or aluminized polyester film with a nominal 20% overlap. When film is used, an AWG# 20 (7 x 28) stranded, tinned, bare drain wire shall be placed between the insulated conductors and the shield and in contact with the conductive surface of the shield.
3. The jacket shall be marked as required by IPCEA/NEMA.

The cable run between each detector and the Traffic Controller cabinet shall be continuous without splices.

Phase Selector

Each phase selector shall conform to the requirements of Chapter I of the State of California, Department of Transportation, "Traffic Signal Control Equipment Specifications", shall be compatible and usable with a Model 170E or 2070 controller unit, and shall be mounted in the input file of a Model 332 or Model 333 JP controller cabinet.

Each phase selector shall be capable of operating at least two or more channels, each of which shall provide and independent output for each separate input.

Each phase selector, when used with its associated optical detectors, shall perform as a minimum, the following:

1. Receive Class I and Class II signals.
2. Decode the signals based on optical frequency, at 9.639 Hz + or -0.119 Hz for Class I signals and 14.035 Hz + or -0.255 Hz for Class II signals.
3. Establish the validity of received signals based on optical frequency and length of time received. A signal shall be considered valid only when received for more than 0.50

second. No combination of Class I signals shall be recognized as a Class II signal regardless of the number of signals being received, up to a maximum of 10 signals. Once a valid signal has been recognized, the effect shall be held by the module, in the event of temporary loss of signal for a minimum period of 4.0 seconds.

4. Provide an output for each channel that will result in a "low" or grounded condition of the appropriate input of a Model 170 controller unit. For a Class I signal, the output shall be a 6.25 Hz + or - 0.1 %, rectangular waveform with a 50 % duty cycle. For Class II signal, the output shall be steady.

Each phase selector shall receive power from the controller cabinet at either 12 VDC or 120 VAC.

Auxiliary inputs for each channel may enter each module through a front panel connector or by a parallel hook-up of the associated detector cables at the input location.

The phase selector shall provide an optically isolated output for each channel to the Model 170 controller unit. All outputs signals shall comply with NEMA signal level definitions and shall be compatible with the Model 170 controller assemblies' inputs.

Each phase selector shall be provided with means of preventing transients received by the detector from affecting the Model 170 controller assembly.

Each phase selector shall have a single connector board and shall occupy one slot of the input file. The front panel of each phase selector module shall have a handle to facilitate withdrawal and have the following controls and functions for each channel:

1. Range adjustments for both class I and Class II signals.
2. A 3-position, center off, momentary contact switch, one position (down) labeled for test operation of Class I signals, and one position (up) labeled for test operation of Class II signals.
3. A "signal" indication and a "call" indication each for Class I and for Class II signals. The "signal" indications denote that a signal, which is not valid, has been received; a "call" indication denotes a steady, valid signal has been received. These 2 indications may be accomplished with a single indication lamp.

In addition, the front panel shall be provided with additional connectors or ports used to perform other functions as specified by the manufacturer.

Cabinet Wiring

Wiring for a Model 332 cabinet shall conform to the following:

1. Slots 12 and 13 of input file "J" shall be wired to accept either a 2 channel or a 4 channel module.

2. Field wiring for the primary detectors, except the 24 VDC power, shall terminate on either terminal block TB-9 in the controller cabinet or on the rear of input file "J", depending on cabinet configuration. Where TB-9 is used, position assignments shall be as follows:
 - a. TB-9 - 1 = Not Used
 - b. TB-9 - 2 = + 24 VDC Out (Orange)
 - c. TB-9 - 3 = + 24 VDC Out (Orange)
 - d. TB-9 - 4 = EVA Detector (Yellow)
 - e. TB-9 - 5 = EVC Detector (Yellow)
 - f. TB-9 - 6 = DC Common Out (Blue)
 - g. TB-9 - 7 = EVB Detector (Yellow)
 - h. TB-9 - 8 = EVD Detector (Yellow)
 - i. TB-9 - 9 = DC Common Out (Blue)

Assuming TB9 - 2 and TB9 - 3 are unused on the "J" File, move wires on J11-J & J11-K (Twisted Pair) to J12-E & J13-E, respectively.

Field wiring for auxiliary detectors may terminate on terminal board TB-0 (If unused) in the controller cabinet. Use manufactures recommended wiring for these connections.

System Operation

The contractor shall demonstrate that the components of each system are compatible and will perform satisfactorily as a system. Satisfactorily performance shall be determined using the following test procedure during the functional test period:

1. Each system to be used for testing shall consist of an optical detector, an optical detector cable and a phase selector module.
2. The phase selector shall be installed in the proper input file slot of the Model 332 or 333 controller cabinet assembly.
3. Two tests shall be conducted; one using a Class I signal emitter and a distance of 1000 feet between the emitter and the detector, the other using a Class II signal emitter and a distance of 1800 feet between the emitter and the detector. Range adjustments on the phase selector shall be set to "Maximum" for each test.
4. During the tests of the Class I and Class II emitters, the proper response from the Model 170E and 2070 controller unit during the "ON" interval and there shall be no improper operation of the Model 170E or 2070 controller unit or the monitor during the "OFF" interval.

The Contractor shall arrange for, and pay the cost of, the services of a knowledgeable representative from the EVP manufacturer, to be present for the first day of the traffic signal and lighting function test to insure proper installation and functioning of the EVP equipment.

The Contractor shall arrange for, and pay the cost of, the services of the controller manufacturer to perform any controller modifications required for the installation, or operation, of the EVP equipment.

Z. GPS Universal Time Sources

The GPS Universal Time Source shall be a McCain model M32755 or approved equal. Approval of any alternate time source shall be determined by the Engineer.

The GPS Universal Time Source shall incorporate a precision GPS receiver and a microprocessor to decode the time signals received from the GPS satellite network. The Universal Time Source shall interface this time signal to a model 170E controller (using Bi-Tran local software) to provide an accurate clock update to the traffic signal controller.

The GPS Universal Time Source shall meet or exceed the following criteria:

- Approximately 6"L x 3.5"W x 1.5"H in size with mounting flanges.
- Operate in temperatures from -30°C to +80°C.
- Receive power through 170E controller's ACIA port.
- Provide 170E controller with the time, date, and day of the week data.
- Software configured time zone and daylight savings operations.
- Support RS-232C serial data rates at 300, 600, 1200, 2400, 48000, 9600 and 19200 bps.
- Provide LED indicators for communication status to a satellite.
- Provide a weatherproof disc antenna no greater than 3" diameter x 1" height to be mounted directly to the top of the traffic signal controller cabinet.
- Provide all cabling and connectors with the correct pin assignments to interface the GPS unit to antenna and to 170E controller.

Proper gaskets or other weatherproofing materials for the antenna shall be supplied and installed to prevent water or moisture from entering the traffic signal controller cabinet.

AA. Battery Backup System

This special provision establishes the minimum requirements for a battery backup system (BBS) that shall provide power to a traffic signal system in the event of a power failure or interruption.

The BBS shall be designed for outdoor applications, in accordance with the current edition of Chapter 1, Section 8 requirements of Transportation Electrical Equipment Specifications (TEES).

The BBS batteries shall be external to the traffic signal controller cabinet as specified under "External Battery Cabinet Option" herein unless specified otherwise. The supplied external cabinet shall be listed on the current Caltrans pre-qualified product list for the external BBS cabinet.

The BBS shall have been installed and operational for a period of one year at an signalized intersection in the United States. The supplied BBS shall be listed on the current Caltrans pre-qualified product list for the BBS.

The BBS shall include, but not limited to the following: cabinet, utility line/generator switch, inverter/charger, power transfer relay, a separate manually operated non-electronic bypass switch, batteries, and all necessary hardware, shelving, and interconnect wiring. The following figure shows BBS components interconnecting with each other and the controller cabinet to ensure interchangeability between all BBS manufacturers.

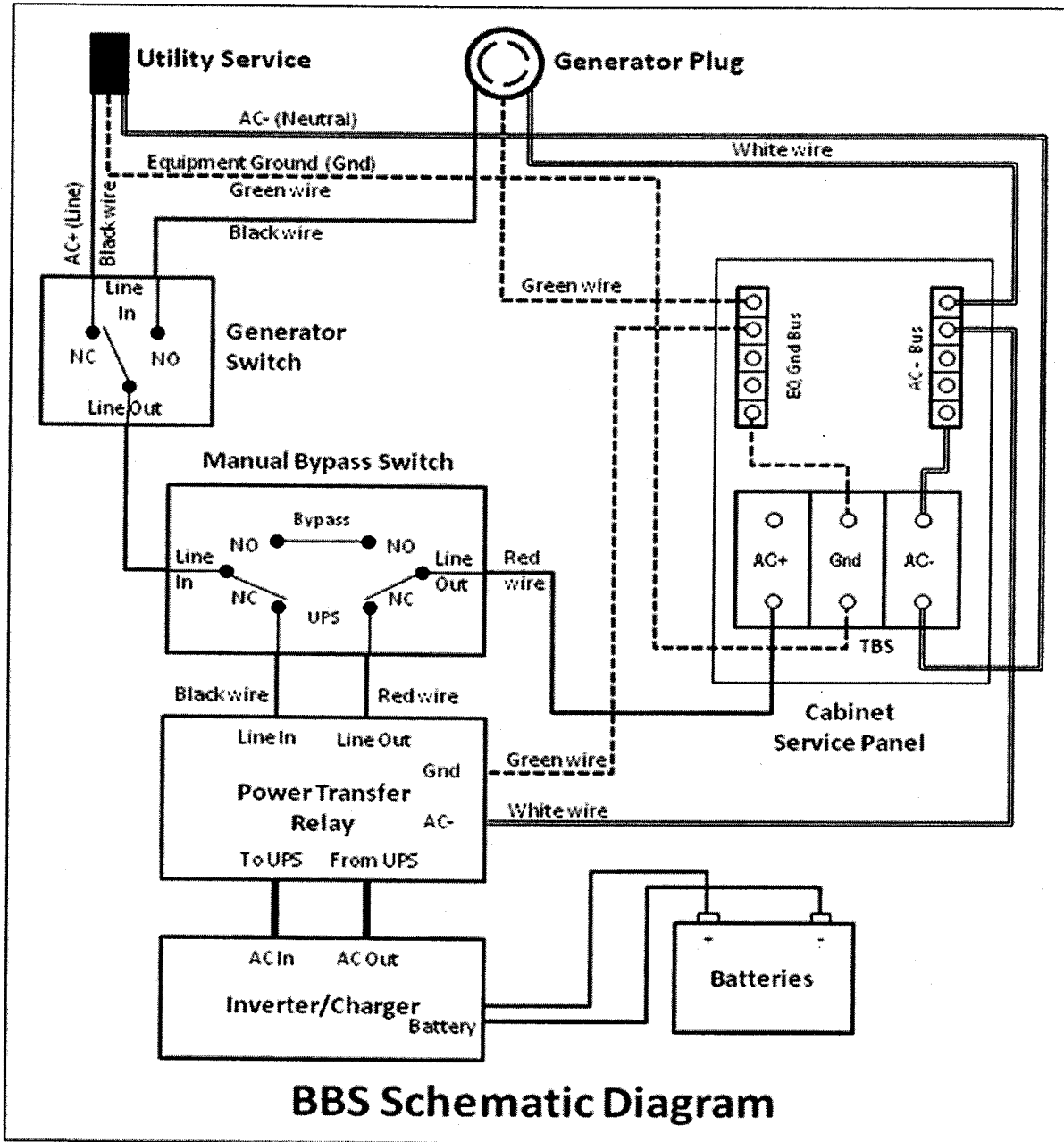

Operation

The BBS shall provide a minimum two (2) hours of full run-time operation for an intersection equipped with all LED traffic signal indications (minimum 1100W active output capacity, with 80% minimum inverter efficiency).

The maximum transfer time allowed, from disruption of normal utility line voltage to stabilized inverter line voltage from batteries, shall be 65 milliseconds. The same maximum allowable transfer time shall also apply when switching from inverter line voltage to utility line voltage.

The BBS shall provide the user with six (6)-sets of fully programmable normally open (NO) and normally closed (NC) single-pole double-throw (SPDT) dry relay contact closures, available on a panel-mounted terminal block, rated at a minimum 120V/1A, and labeled so as to identify each contact. See below figure for typical configuration.

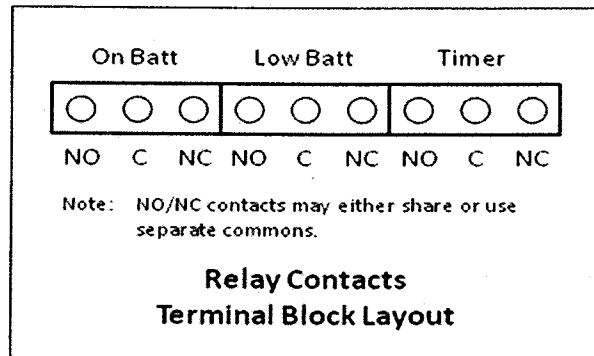

The first set of NO and NC contact closures shall be energized whenever the unit switches to battery power. Contact shall be labeled or marked "On Batt".

The second set of NO and NC contact closures shall be energized whenever the battery approaches approximately 40% of remaining useful capacity. Contact shall be labeled or marked "Low Batt".

The third set of NO and NC contact closures shall be energized two hours after the unit switches to battery power. Contact shall be labeled or marked "Timer".

The six programmable NO and NC contact closures shall be independently configured to activate under any of the following conditions: On Battery, Low Battery, Timer, Alarm, or Fault.

Operating temperature for inverter/charger, power transfer relay and manual bypass switch shall be $-37\text{ }^{\circ}\text{C}$ to $+74\text{ }^{\circ}\text{C}$.

Both the Power Transfer Relay and Manual Bypass Switch shall be rated at 240VAC/30 amps, minimum.

The BBS shall use a temperature-compensated battery charging system. The charging system shall compensate over a range of $2.5 - 4.0\text{ mV/ }^{\circ}\text{C}$ per cell.

The temperature sensor shall be external to the inverter/charger unit. The temperature sensor shall come with 10' of wire.

Batteries shall not be recharged when battery temperature exceeds $50\text{ }^{\circ}\text{C} \pm 3\text{ }^{\circ}\text{C}$.

BBS shall bypass the utility line power whenever the utility line voltage is outside of the following voltage range: 100VAC to 130VAC (± 2 VAC).

When utilizing battery power, the BBS output voltage shall be between 110 VAC and 125 VAC, pure sine wave output, $\leq 3\%$ THD, 60Hz ± 3 Hz.

BBS shall be compatible with NEMA and Model 332 and 333JP Cabinets, and Model 170, 390 & 2070 Controllers and cabinet components for full time operation.

In cases of low (below 100VAC) or absent utility line power, when the utility line power has been restored at above 105 VAC ± 2 VAC for more than 30 seconds, the BBS shall transfer from battery backed inverter mode back to utility line mode.

In cases of high utility line power (above 130VAC), when the utility line power has been restored at below 125VAC ± 2 VAC for more than 30 seconds, the BBS shall transfer from battery backed inverter mode back to utility line mode.

The BBS shall have an automatic tap to step up or step down the output voltage by 10 percent. The resulting output voltages shall remain within the above prescribed voltage range: 100VAC to 130VAC. This capability will extend BBS range for operating on input AC and not reverting to battery power.

BBS shall be equipped to prevent a malfunction feedback to the cabinet or from feeding back to the utility service.

In the event of inverter/charger failure, battery failure or complete battery discharge, the power transfer relay shall revert to the NC (and de-energized) state, where utility line power is connected to the cabinet.

Recharge time for the battery, from "protective low-cutoff" to 80% or more of full battery charge capacity, shall not exceed twenty (20) hours.

Mounting / Configuration

Generator Switch, Inverter/Charger, Power Transfer Relay and manually operated Bypass Switch shall fit inside a typical fully equipped traffic signal controller cabinet.

Mounting method inside the 332 and 333JP cabinet shall be shelf-mount, rack-mount or combination of either. Available rack space for front-mounted inside the 332 and 333JP cabinet is 3U or approximately 6 inches.

All interconnect wiring provided between Generator Switch, Inverter/Charger, Power Transfer Relay, Bypass Switch and Cabinet Terminal Service Block shall be no less than 9 feet of UL Style 1015 CSA TEW with the following characteristics:

- AWG Rating: 10 AWG
- Stranding: 105 strands of 10 AWG tinned copper
- Rating: 600 V, 105 °C, PVC Insulation

Relay contact wiring provided for each set of NO/NC relay contact closure terminals shall be 9 feet of UL Style 1015 CSA TEW 18 AWG wire, same ratings as above, except 16 strands of 18 AWG tinned copper.

All necessary hardware for mounting (shelf angles, rack, etc) shall be included in the **contract price paid** for the BBS, and no additional compensation will be allowed therefor.

Internal mounted battery option

(Allowed only if requested on the plans)

The controller cabinet shall be equipped with a generator twist lock flanged inlet receptacle, manual transfer switch and bypass switch.

The twist lock flanged inlet receptacle shall be Hubbell 2615, NEMA L5-30P Twist Lock Flanged Male Inlet Rated for 30A/125VAC or approved equal. Receptacle shall be mounted flush to the cabinet in a weatherproof lift cover plate made of impact-resistant thermoplastic and gray in color.

The bypass switch shall transfer the load, including the UPS to the twist lock inlet receptacle. The manual transfer switch shall be wired to prevent any back feed to the utility service. Both the bypass switch and manual transfer switch shall be rack mounted independently in the controller cabinet meeting industry standards.

Batteries shall be mounted on swing-tray mounted below the controller shelf. A minimum of six (6) bolts/fasteners shall be used to secure swing-trays to the 332 Cabinet standard EIA 19" rack. All bolts/fasteners and washers shall meet the following requirements:

- Screw type: Pan Head Phillips machine screw
- Size and Thread pitch: 10-32
- Material: 18-8 stainless steel (Type 316 stainless steel is acceptable as an alternate)
- Washer: Use one 18-8 stainless steel flat washer under the head of each 10-32 screw; lock washers are unnecessary provided that the screws are properly tightened.

Number of screws per swivel bracket: minimum six (6) screws per swivel bracket. Screws are to be spaced evenly along bracket, with one screw near each end. Batteries may be shelf mounted in area behind controller so long as shelf and batteries do not interfere with controller unit and C1 plug.

External battery cabinet option

Batteries shall be housed in an external cabinet mounted to the side of the controller cabinet as shown in the following figure or as directed by the Engineer with a minimum of eight (8) bolts:

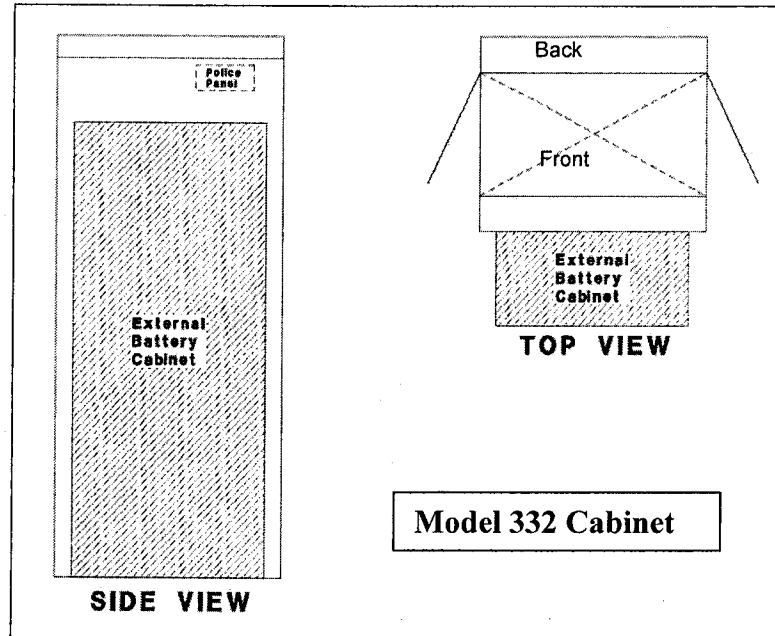

If BBS is installed at the back of controller cabinet, the modification shall include a minimum of 36 inches wide concrete walkway access to the BBS without encroaching outside the right-of-way. BBS shall be installed at the front of the controller cabinet (in locations where the back of the controller cabinet has limited ROW or conflicting structures and facilities and other obstructions), the BBS cabinet shall not cover the police panel. The BBS cabinet shall also not hinder the access ramp's compliance with ADA requirements.

Four shelves shall be provided within the battery cabinet. There shall be a minimum of 12 inches clearance between shelves. Each shelf shall be a minimum of 9" X 25", and capable of supporting a minimum of 125 lbs. Batteries shall be mounted on individual shelves.

The external battery cabinet shall be NEMA 3R rated in accordance to Section 2-Housings of the Chapter 7 of TEES, for the construction of the cabinet and anodic coating finish.

The external battery cabinet shall be ventilated through the use of louvered vents, filter, and one thermostatically controlled fan in accordance to Section 2-Housings of the Chapter 7 of TEES.

External battery cabinet fan shall be AC operated from the same line output of the Manual Bypass Switch that supplies power to the controller cabinet.

The external battery cabinet shall have a door opening to the entire cabinet. The door shall be attached to the cabinet through the use of a continuous stainless steel piano hinge or four, two-bolts per leaf, hinges in accordance to Section 2-Housings of the Chapter 7 of TEES. The door shall use a three-point, roller locking mechanism and standard #2 key lock to lock the door. The door shall have a stainless steel handle.

The external cabinet shall be equipped with a generator twist lock flanged inlet receptacle, manual transfer switch and bypass switch.

The twist lock flanged inlet receptacle shall be Hubbell 2615, NEMA L5-30P, Twist Lock Flanged Male Inlet Rated for 30A/125V or approved equal. Receptacle shall be mounted flush to the cabinet in a weatherproof lift cover plate made of impact-resistant thermoplastic and gray in color.

The bypass switch shall transfer the load, including the UPS to the twist lock inlet receptacle. The manual transfer switch shall be wired to prevent any back feed to the utility service. Both the bypass switch and manual transfer switch shall be rack mounted independently in BBS cabinet meeting industry standards.

The BBS with external battery cabinet shall come with all bolts, conduits and bushings, gaskets, shelves, and hardware needed for mounting.

Maintenance, Displays, Controls And Diagnostics

The BBS shall include a 2 line by 40 character LCD display to indicate current battery charge status, input/output voltages, time and settings of various conditions. The same parameters shall be available via RS232 or USB interfaces on the face of the BBS.

The BBS shall have lightning surge protection compliant with IEEE/ANSI C.62.41.

The BBS shall be capable of accepting firmware upgrades of the non-volatile, read-only memory via serial port communications. The updates shall be accomplished by uploading the software to the BBS over the RS232 serial port located on the face of the BBS.

The BBS shall be equipped with an integral system to prevent battery from destructive discharge and overcharge.

The BBS shall be capable of performing a SELF-TEST, locally from the BBS front panel LCD, or remotely via RS232 or USB interface. The duration of the SELF-TEST shall be programmable in 1-minute increments from 1 minute to 255 minutes.

The BBS and batteries shall be easily replaced with all needed hardware and shall not require any special tools for installation.

The BBS shall include a re-settable inverter event counter to indicate the number of times the BBS was activated and the total number of hours the unit has operated on battery power, accessible via the LCD screen or remotely via RS232 or USB.

The BBS shall be equipped with an event log that stores for a minimum the last 100 events. The events shall be time and date stamped. The event log shall be retrievable via RS232, USB or from the BBS LCD screen. The event log shall be display and print out in plain English when output the RS232 or USB ports.

Battery System

Individual batteries shall be 12V, 105 amp-hour for 20 hours to 1.70 VPC @ 77F, and shall be easily replaced and commercially available off the shelf.

Batteries used for BBS shall consist of four (4) batteries with a cumulative minimum rated capacity of 420 amp-hours.

Batteries shall be deep cycle, sealed prismatic lead-calcium based AGM/VRLA (Absorbed Glass Mat/ Valve Regulated Lead Acid).

Batteries shall be certified by the manufacturer to operate over a temperature range of – 25 °C to +74 °C.

The batteries shall be provided with appropriate interconnect wiring and corrosion-resistant mounting trays and/or brackets appropriate for the cabinet into which they will be installed.

Batteries shall indicate maximum recharge data and recharging cycles.

Battery Harness

Battery interconnect wiring shall be via two-part modular harness:

- Part I shall be equipped with red (+) and black (-) cabling that can be permanently connected to the positive and negative posts of each battery. Each red and black pair shall be terminated into a Molex, polarized – keyed battery cable connector or equivalent. The length of the harness between batteries shall be a minimum of 12 inches.
- Part II shall be equipped with the mating Power Pole style connector for the batteries and a single, insulated Power Pole style connection to the inverter/charger unit. Harness shall be fully insulated and constructed to allow batteries to be quickly and easily connected in any order to ensure proper polarity and circuit configuration. The length of the battery interconnect harness shall be a minimum of 60 inches from the Inverter/Charger plug to the first battery in the string.

Power Pole connectors may be either one-piece or two-piece. If a two-piece connector is used, a locking pin shall be used to prevent the connectors from separating.

All battery interconnect harness wiring shall be UL Style 1015 CSA TEW or Welding Style Cable or equivalent, all of proper gauge with respect to design current and with sufficient strand count for flexibility and ease of handling.

Battery terminals shall be covered and insulated with molded boots to prevent accidental shorting.

BBS Quality Assurance

Each Battery Backup System (BBS) shall be manufactured in accordance with a manufacturer Quality Assurance (QA) program. The QA program shall include two Quality Assurance procedures:

1. Design QA - The manufacturer, or an independent testing lab hired by the manufacturer, shall perform Design Qualification Testing on new BBS system(s) offered, and when any major design change has been implemented on an existing design. A major design change is defined as any modification - material, electrical, physical, or theoretical, that changes any performance characteristics of the system, or results in a different circuit configuration. Where a dispute arises in determining if a system is a new design or if the system has had a major design change, the County will make the final determination if Design Qualification Testing is required prior to production consideration.
2. Production QA - The Production QA shall include statistically controlled routine tests to ensure minimum performance levels of BBS units built to meet this specification and a documented process of how problems are to be resolved.

QA process and test results documentation shall be kept on file for a minimum period of seven years.

Battery Backup System designs not satisfying Design QA Testing and Production QA Testing requirements shall not be labeled, advertised, or sold as conforming to this specification.

The Contractor shall arrange to have a technician, qualified to work on the battery backup system and employed by the battery backup system manufacturer or employed by the manufacturers authorized distributor, present at the time the equipment is turned on. It shall be the responsibility of the Contractor to implement and fund any traffic signal controller assembly modifications required to achieve the traffic signal operation as shown on the construction plans and as required in the Special Provisions.

BB. Payment Method.

See Signal and Lighting subsection O, "Service" for payment of all electric company fees required.

The contract price paid **per Lump Sum** for Signal and Lighting shall include full compensation for furnishing all labor, materials, tools, equipment, foundations, pole and mast arm mounted regulatory signs, documents, programming, testing, and incidents and for doing all the work specified herein, elsewhere in these Special Provisions, and plans including the complete installation of an operational traffic signal and lighting system and no additional compensation shall be allowed therefor.

DE-MOBILIZATION:

De-mobilization shall consist of the completion of all final construction and administrative work required to secure the project for termination and acceptance by the Engineer, including, but not limited to the following:

1. Satisfactory completion of Finishing Roadway in accordance with Section 22, "Finishing Roadway" of the Standard Specifications;
2. Removal of all temporary facilities, temporary utilities, plant, equipment, surplus material, construction debris and similar from project limits and adjacent property, as required and as directed by the Engineer;
3. Completion of record of drawings (as-builts), to the satisfaction of the Engineer;
5. Submission of final certified payroll documents to the Engineer;
7. Submission of property owner releases, as required by the Engineer (if any);
8. Completion of the requirements of permits issued by other agencies;
9. Satisfactory completion of all other contractually and legally required construction and administrative items of work.

De-Mobilization shall include the satisfactory completion of all items of work, but shall not be construed as being a separate payment for work that is paid under separate contract items. The contract item for De-Mobilization is intended for proper close-out activities.

Payment:

De-Mobilization will be made on a lump sum basis in the amount of the fixed bid price after satisfactory completion of the above listed items. Payment for De-Mobilization will be included in the final pay estimate and payment. No partial payments will be made for De-Mobilization.

POLYVINYL CHLORIDE (PVC) FENCE:

Polyvinyl Chloride (PVC) Post Fence shall be white in color and consisting of 5"x5" PVC posts eight (8) feet apart center to center, and 2"x6" PVC rails (two rails) as specified on the contract plans and these special provisions.

PART 1 EXECUTION

1.01 INSTALLATION

- A. Set structural members level, plumb, and true to line. Discard pieces with defects that would lower required strength or result in unacceptable appearance of exposed members.
- B. Make provisions for temporary construction loads, and provide temporary bracing sufficient to maintain structure in true alignment and safe condition until completion of erection and installation of permanent bracing.
- C. Install structural members full length without splices unless otherwise specifically detailed.
- D. Comply with member sizes, spacing, and configurations indicated, and fastener size and

spacing indicated, but not less than required by applicable codes.

1.02 TOLERANCES

- A. Framing Members: 1/4 inch from true position, maximum.
- B. Variation from Plane (Other than Floors): 1/4 inch in 10 feet maximum, and 1/4 inch in 30 feet maximum.

1.03 CLEANING

- A. Waste Disposal: Comply with the requirements of Section 01732.
 - 1. Comply with applicable regulations.
 - 2. Do not burn scrap on project site.
- B. Do not leave any PVC, Appurtenances, etc. on the ground or buried in fill.
- C. Prevent PVC Appurtenances from entering the storm drainage system.

1.04 OTHERS

Contractor shall provide a written warranty card including all terms and conditions for material defects and others. All beams shall be staggered per Engineer's directions. The PVC fence material shall be Solid-Wall Extrusion and UV protected.

Payment:

The contract unit bid prices paid per linear foot for PVC Fence and shall be considered full compensation for furnishing all labor, materials, tools, equipment, and incidentals and for doing all the work involved and no additional compensation will be allowed therefor.

REFERENCE DRAWINGS

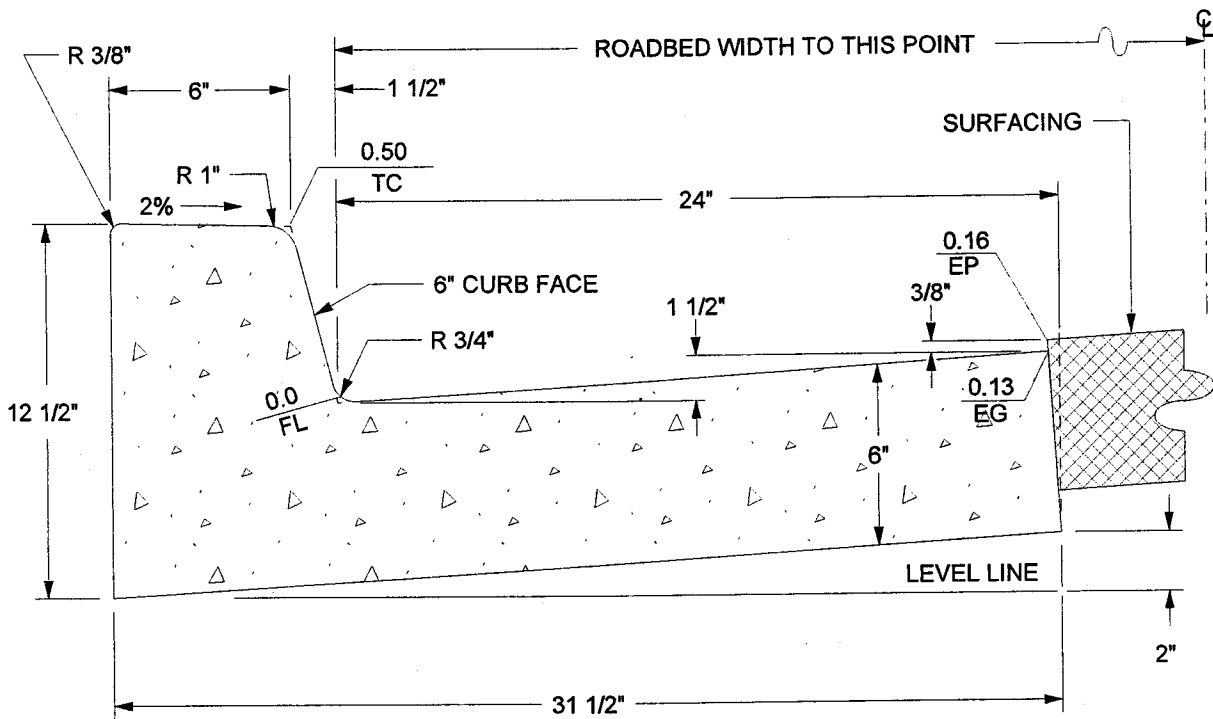

CLASS "B" CONCRETE
 1.601 CU. FT. / L.F.
 1 CU. YD. = 16.86 L.F.

ABBREVIATIONS:
 TC = TOP OF CURB
 FL = FLOWLINE
 EG = EDGE OF GUTTER
 EP = EDGE OF PAVEMENT

APPROVED BY:

George A. Johnson
 DIRECTOR OF TRANSPORTATION
 GEORGE A. JOHNSON, RCE 42328

DATE: 05/01/07

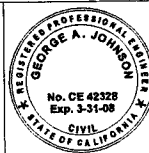

COUNTY OF RIVERSIDE

TYPE A-6 CURB

STANDARD NO. 200

REVISIONS	REV.	BY:	APR'D	DATE	REV.	BY:	APR'D	DATE
8-71, 9-88	1				4			
2-90, 11-04	2				5			
	3				6			

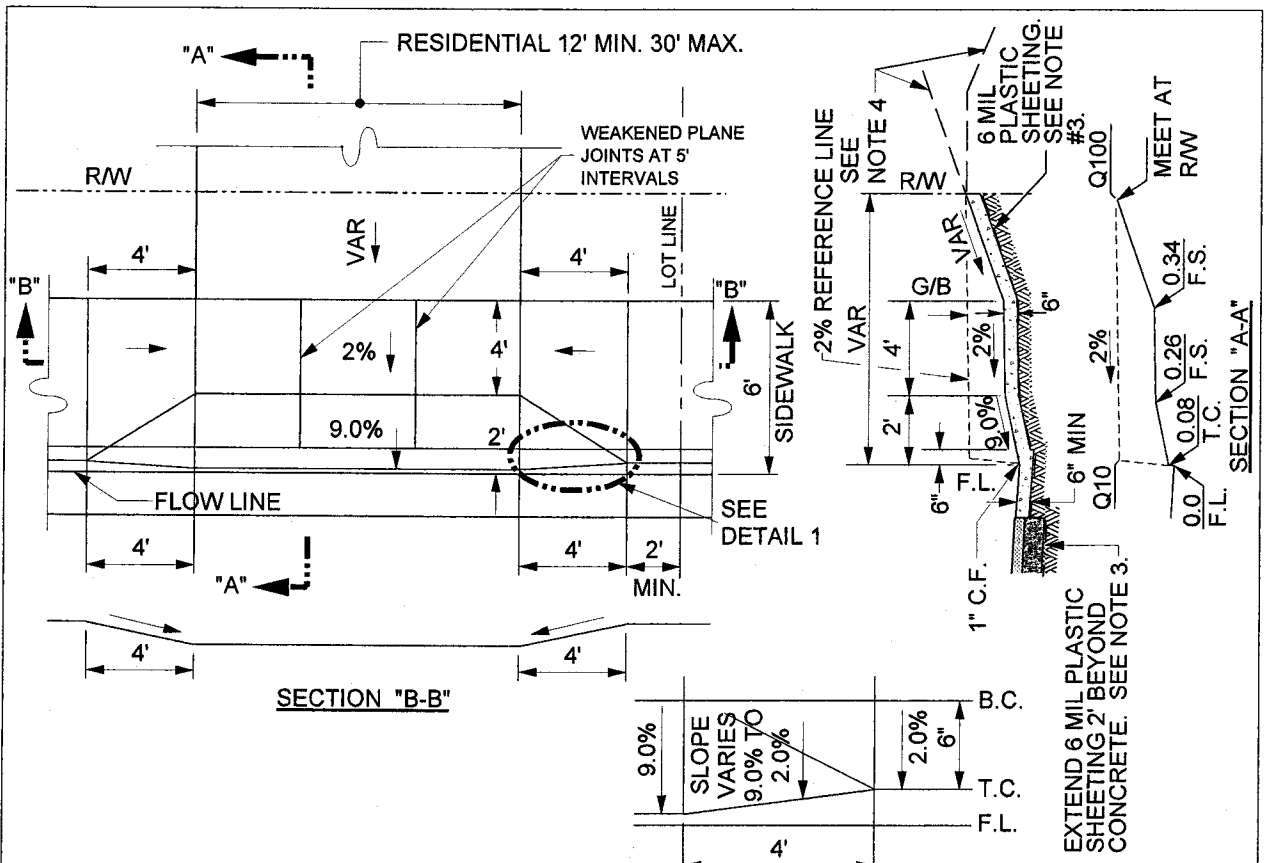

NOTES:

1. ALL CONSTRUCTION SHALL BE CLASS "3" CONCRETE.
2. 20' OF FULL-HEIGHT CURB REQUIRED BETWEEN DRIVEWAYS WITHIN ANY ONE PROPERTY FRONTAGE.
3. USE 6 MIL PLASTIC SHEETING WHEN ABUTTING SOIL HAS A HIGH SULFATE CONTENT, SPECIAL CONSIDERATIONS ARE REQUIRED. SEE SPECIFICATIONS (SECTION 16.04).
4. CONSTRUCT THE PROFILE GRADE OF THE PRIVATE ON-SITE DRIVEWAY SO THAT IT PROVIDES SMOOTH VEHICLE ACCESS OVER THE DRIVE APPROACH.

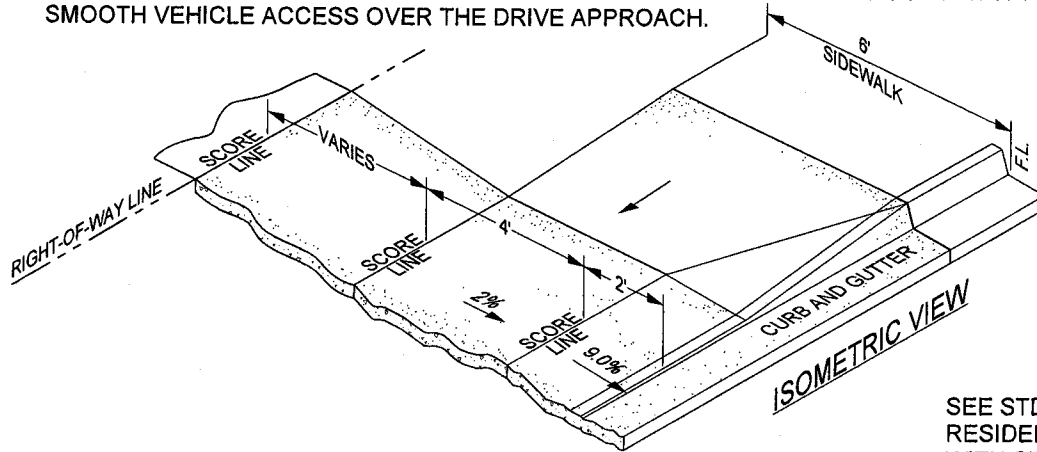

NOT TO SCALE

SEE STD NO. 213 FOR RESIDENTIAL DRIVEWAY WITH SIDEWALK AT R/W

APPROVED BY:

George A. Johnson
 DIRECTOR OF TRANSPORTATION
 GEORGE A. JOHNSON, RCE 42328

DATE: 11/15/04

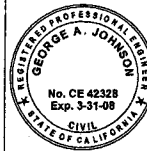

COUNTY OF RIVERSIDE

RESIDENTIAL DRIVEWAY WITH SIDEWALK AT CURB

REVISIONS	REV.	BY:	APR'D	DATE	REV.	BY:	APR'D	DATE
8-71, 8-77	11-04	1			4			
5-80, 2-82		2			5			
2-90, 12-97		3			6			

STANDARD NO. 207



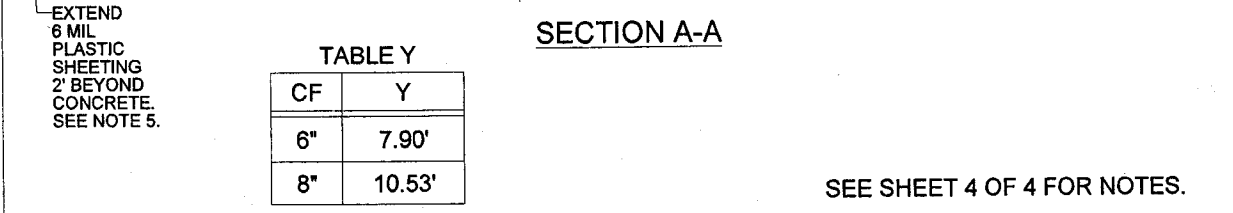
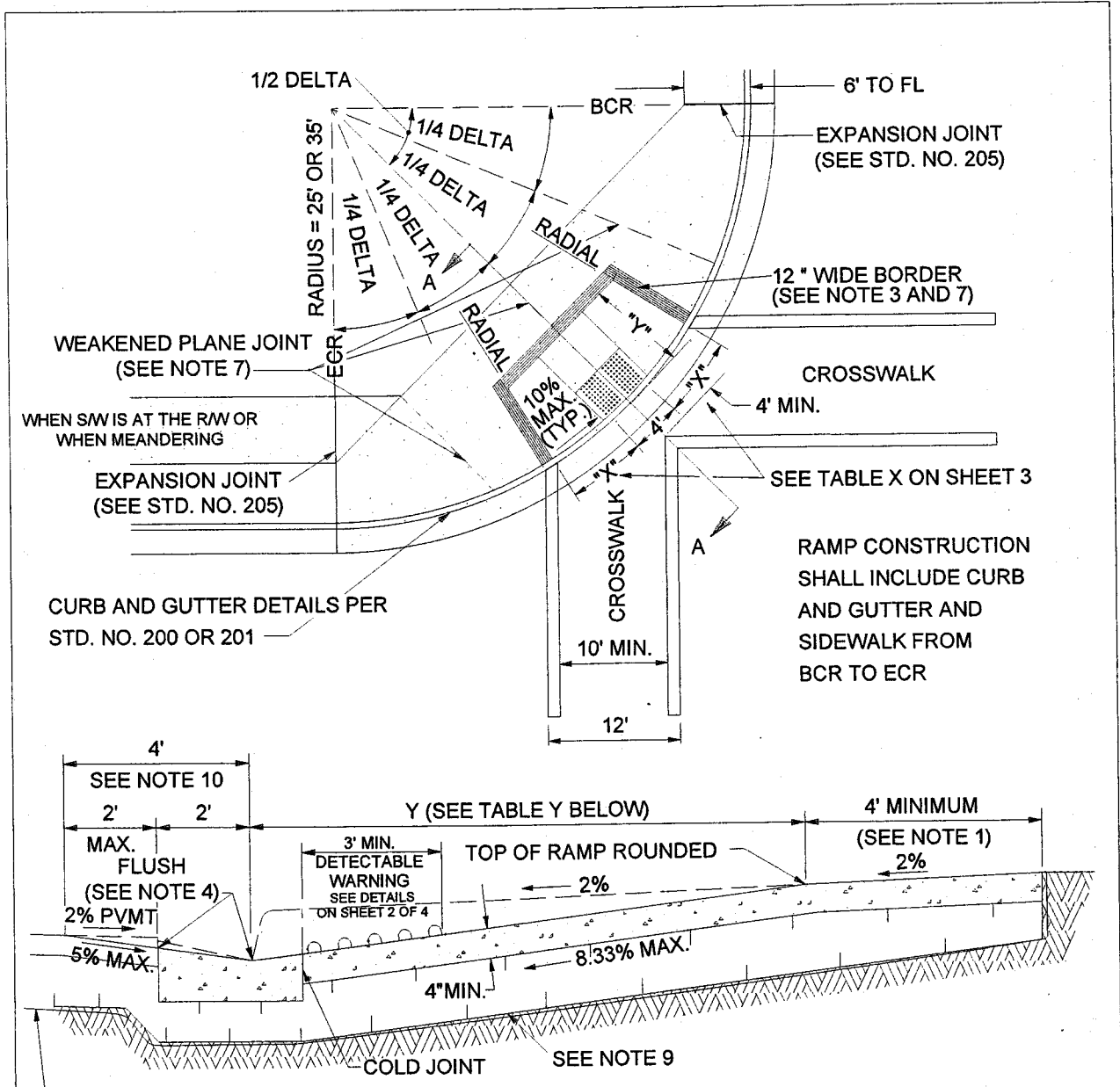

TABLE Y

CF	Y
6"	7.90'
8"	10.53'

$$Y = \frac{\text{CURB FACE (FT.)}}{6.33\%}$$

SECTION A-A
NOT TO SCALE

SEE SHEET 4 OF 4 FOR NOTES.

APPROVED BY: <i>George A. Johnson</i> DIRECTOR OF TRANSPORTATION GEORGE A. JOHNSON, RCE 42328				DATE: 11/15/04								COUNTY OF RIVERSIDE			
												<p>CURB RAMP CASE A</p>			
REVISIONS		REV.	BY:	APR'D	DATE	REV.	BY:	APR'D	DATE	STANDARD NO. 403 (1 OF 4)					
8-77, 5-80	11-04	1				4									
10-81, 6-82		2				5									
9-88, 2-90		3				6									

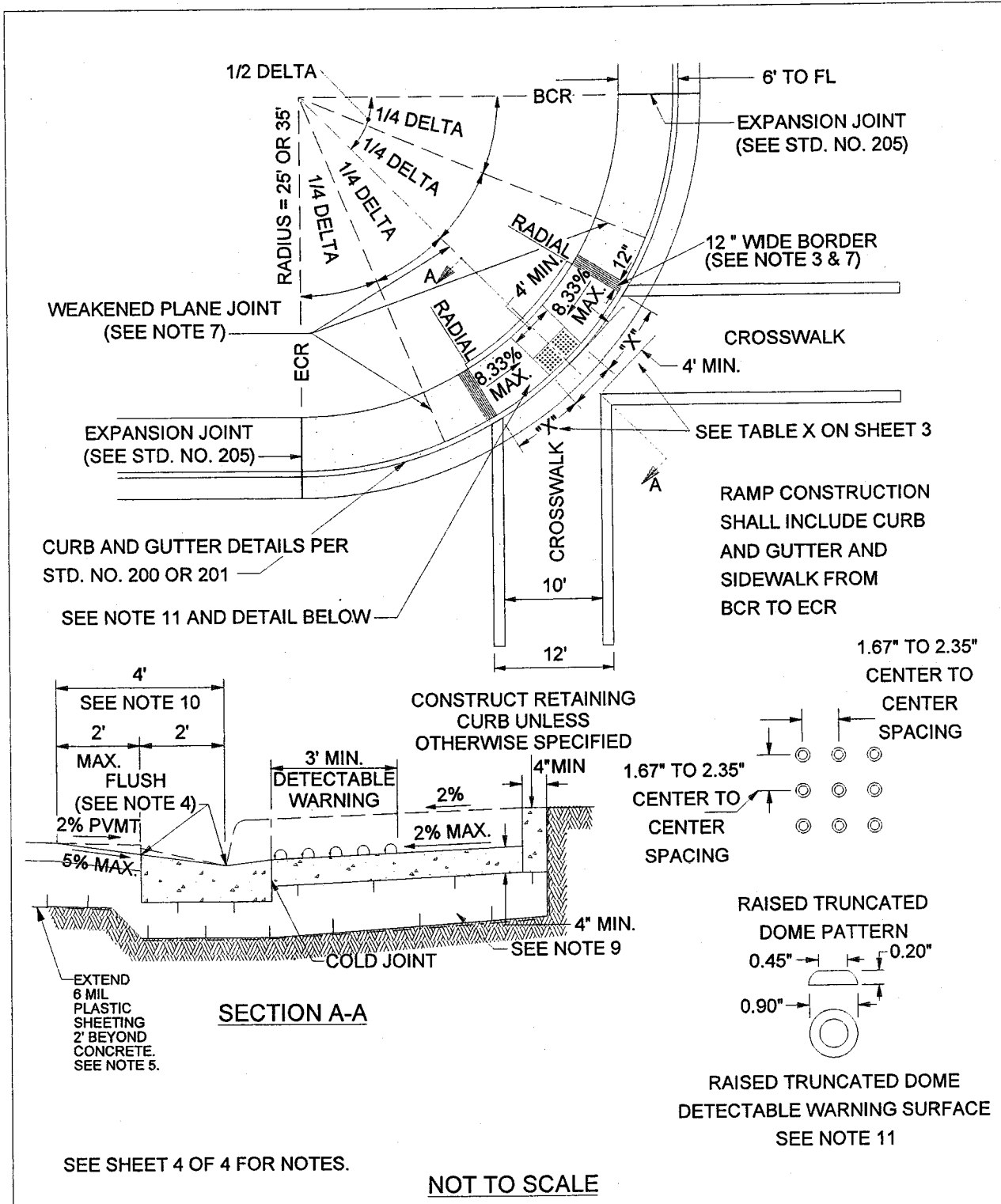

APPROVED BY:
George A. Johnson DATE: 11/15/04
 DIRECTOR OF TRANSPORTATION
 GEORGE A. JOHNSON, RCE 42328



COUNTY OF RIVERSIDE

**CURB RAMP
 CASE B**

REVISIONS		REV.	BY:	APR'D	DATE	REV.	BY:	APR'D	DATE
8-77, 5-80	11-04	1				4			
10-81, 6-82		2				5			
9-88, 2-90		3				6			

STANDARD NO. 403 (2 OF 4)
 12-97

NOT TO SCALE

SEE SHEET 4 OF 4 FOR NOTES.

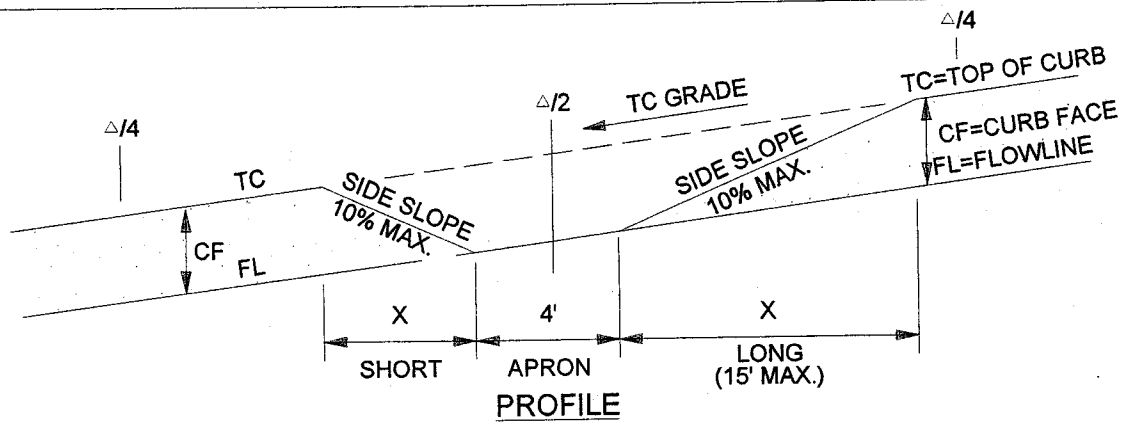

TABLE X

CF (IN)	RADIUS (FT)	SIDE SLOPE	X	TC GRADE (ALONG CURB RETURN)					
				1%	2%	3%	4%	5%	6%
6"	35'	10%	X _S	4.6	4.2	3.9	3.6	3.4	3.2
			X _L	5.6	6.3	7.2	8.4	10.0	12.5
8"	35'	10%	X _S	6.1	5.6	5.2	4.8	4.5	4.2
			X _L	7.5	8.4	9.6	11.2	13.4	15.0

TO CALCULATE "X" DIMENSION:

SHORT SIDE (DOWN SLOPE): $X_S (FT) = \frac{\text{CURB FACE (FT)}}{\text{SIDE SLOPE} + \text{TC GRADE}}$

LONG SIDE (UP SLOPE): $X_L (FT) = \frac{\text{CURB FACE (FT)}}{\text{SIDE SLOPE} - \text{TC GRADE}}$

ENGINEER TO SHOW X_S AND X_L ON IMPROVEMENT PLANS

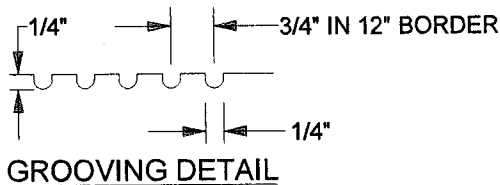

APPROVED BY:								COUNTY OF RIVERSIDE			
								DATE: 05/05/07		<p>CURB RAMP</p>	
DIRECTOR OF TRANSPORTATION GEORGE A. JOHNSON, RCE 42328						STANDARD NO. 403 (3 OF 4)					
REVISIONS		REV.	BY:	APR'D	DATE			REV.	BY:	APR'D	DATE
8-77, 5-80		11-04	1					4			
10-81, 6-82			2					5			
9-88, 2-90			3			6					

CONSTRUCTION NOTES:

1. IF DISTANCE FROM CURB TO BACK OF SIDEWALK IS TOO SHORT TO ACCOMMODATE RAMP AND 4' LANDING, THEN USE THE CASE "B" RAMP.
2. IF SIDEWALK IS LESS THAN 6' WIDE, THE FULL WIDTH OF THE SIDEWALK SHALL BE DEPRESSED AS SHOWN IN CASE B. MINIMUM SIDEWALK WIDTH IS 4' FROM BACK OF CURB.
3. THE RAMP SHALL HAVE A 12" WIDE BORDER WITH GROOVES 1/4" WIDE AND 1/4" DEEP APPROXIMATELY 3/4" ON CENTER. SEE GROOVING DETAIL.
4. TRANSITIONS FROM RAMPS TO WALKS, GUTTERS, OR STREETS SHALL BE FLUSH AND FREE OF ABRUPT CHANGES.
5. WHEN ABUTTING SOIL HAS A HIGH SULFATE CONTENT, SPECIAL CONSIDERATIONS ARE REQUIRED. SEE SPECIFICATIONS (SECTION 16.04).
6. RAMP SIDE SLOPE VARIES UNIFORMLY FROM A MAXIMUM OF UP TO 10% AT CURB TO CONFORM WITH LONGITUDINAL SIDEWALK SLOPE ADJACENT TO TOP OF THE RAMP (EXCEPT IN CASE B).
7. CONSTRUCT WEAKENED PLANE JOINTS AT 1/4 DELTAS WHEN RADIUS EQUALS 35' AND AT INSIDE EDGE OF GROOVED BORDER WHEN RADIUS EQUALS 25'.
8. IF EXPANSIVE SOIL IS ENCOUNTERED, THEN RAMP SHALL BE CONSTRUCTED OVER CLASS 2 AGGREGATE MATERIAL.
9. CONCRETE SHALL BE CLASS B.
10. MAXIMUM SLOPES OF ADJOINING GUTTERS: THE ROAD SURFACE IMMEDIATELY ADJACENT TO THE CURB RAMP AND CONTINUOUS PASSAGE TO THE CURB RAMP SHALL NOT EXCEED 5% WITHIN 4' OF THE BOTTOM OF THE CURB RAMP.
11. DETECTABLE WARNING SURFACES ARE REQUIRED ON ALL CURB RAMPS THAT ENTER INTO A VEHICULAR TRAVEL WAY.

APPROVED BY:

George A. Johnson
 DIRECTOR OF TRANSPORTATION
 GEORGE A. JOHNSON, RCE 42328

DATE: 11/15/04

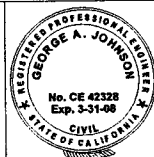

COUNTY OF RIVERSIDE

**CURB RAMP
 CONSTRUCTION NOTES**

REVISIONS		REV.	BY:	APR'D	DATE	REV.	BY:	APR'D	DATE
8-77, 5-80	11-04	1				4			
10-81, 6-82		2				5			
9-88, 2-90		3				6			

STANDARD NO. 403 (4 OF 4)
 12-97

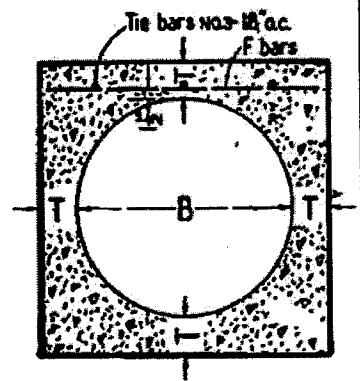
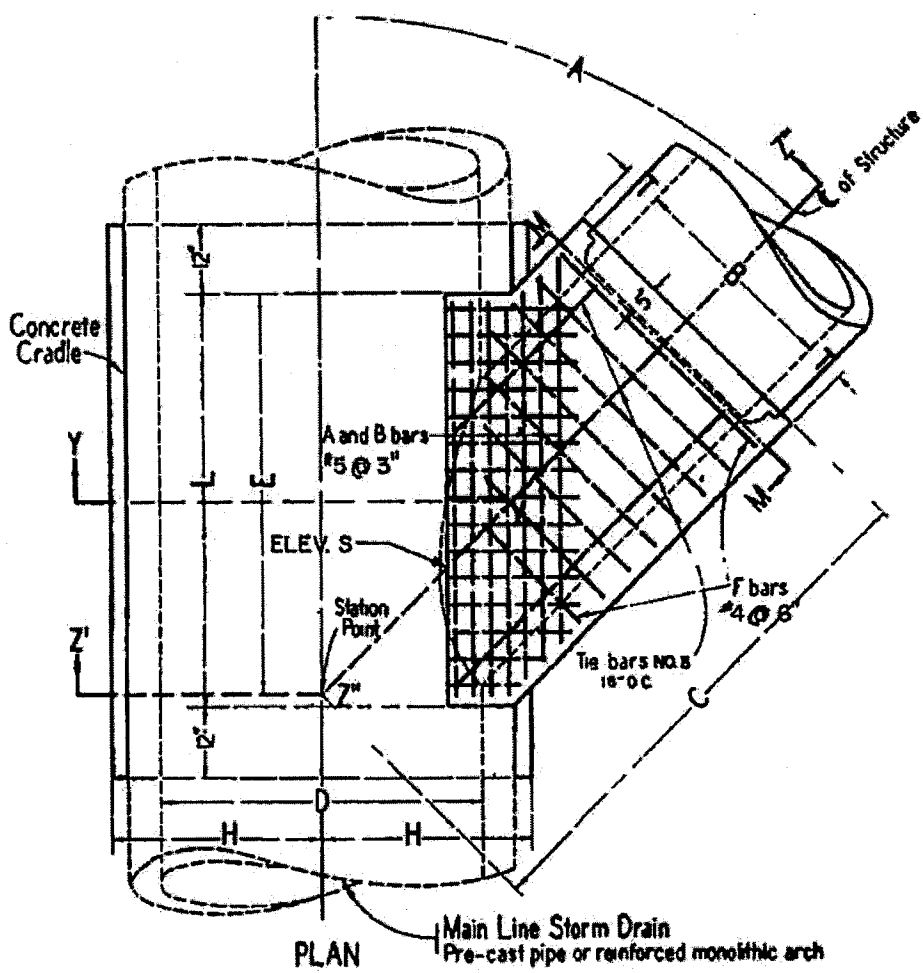

SECTION M-M

TABLE OF VALUES FOR T	
B	T
12"	4"
15"	4 1/2"
18"	4 1/2"
21"	5"
24"	5 1/2"
27"	5 3/4"
30"	6"
33"	6 1/2"
36"	6 3/4"
39"	7"

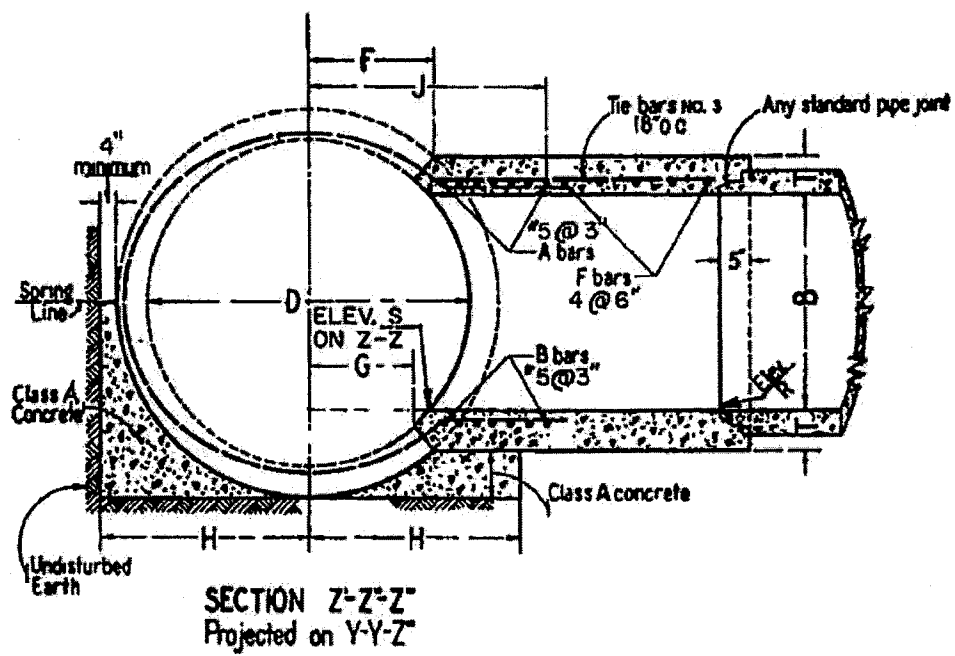

SECTION Z-Z' Projected on Y-Y-Z'

CITY OF RIV. STD. NO. 421
L.A.G.F.C.D. STD. NO. 2-D112



RIVERSIDE COUNTY FLOOD CONTROL
AND
WATER CONSERVATION DISTRICT
APPROVED BY: *Warren D. Willett*
CHIEF ENGINEER
DATE: April 5, 2004
R.C.E. NO. 32336

JUNCTION STRUCTURE
NO. 2
STANDARD DRAWING NUMBER JS227
SHEET 1 OF 2

NOTES FOR JUNCTION STRUCTURE NO. 2

1. VALUES for A, B, C, D, E, F, G, L, Elevation R, and Elevation S shown on improvement plan.
2. PIPE shall be cradled in class A concrete extending longitudinally to points 1 ft. beyond the limits of $L R = \frac{1}{2}$ outside diameter of pipe + 4" as a minimum. Cradle may be omitted on side opposite lateral inlet when constructed in connection with existing pipe storm drain.
3. A AND B BARS shall be carried to point not less than J distance from center line, $J = \frac{7D}{12} + 6"$.
4. RECTANGULAR OPENING in main line pipe shall be cut within these limits normal to pipe surface without damaging steel. Values for F, G, and L on improvement plan.
5. TRANSVERSE REINFORCEMENT in pipe shall be cut in center of opening and bent to uniform distance from top and bottom of junction structure.
6. STRUCTURAL CONCRETE shall be CLASS "A"
7. REINFORCING STEEL shall be round, deformed, straight bars, $1\frac{1}{2}"$ clear from inside face of concrete unless otherwise shown.
8. STEEL SCHEDULE as shown.
9. MONOLITHIC ARCH: When Junction Structure No. 2 is specified with reinforced monolithic arch storm drain, value D shall refer to the clear span of the arch. Reinforcing steel shall be cut and bent into junction structure the same as for pipe. Concrete cradle under reinforced monolithic arch is not required.
10. FLOOR of structure shall be steel-troweled to springing line.

CITY OF RIV. STD. NO. 421
 L.A.C.F.C.D. STD. NO. 2-D112
 CITY OF L.A. STD. NO. B-1529



RIVERSIDE COUNTY FLOOD CONTROL AND WATER CONSERVATION DISTRICT	
APPROVED BY: <i>Warren D. Williams</i>	
CHIEF ENGINEER	
DATE: April 5, 2004	R.C.E. NO. 32336

JUNCTION STRUCTURE NO. 2
STANDARD DRAWING NUMBER JS227 SHEET 2 OF 2

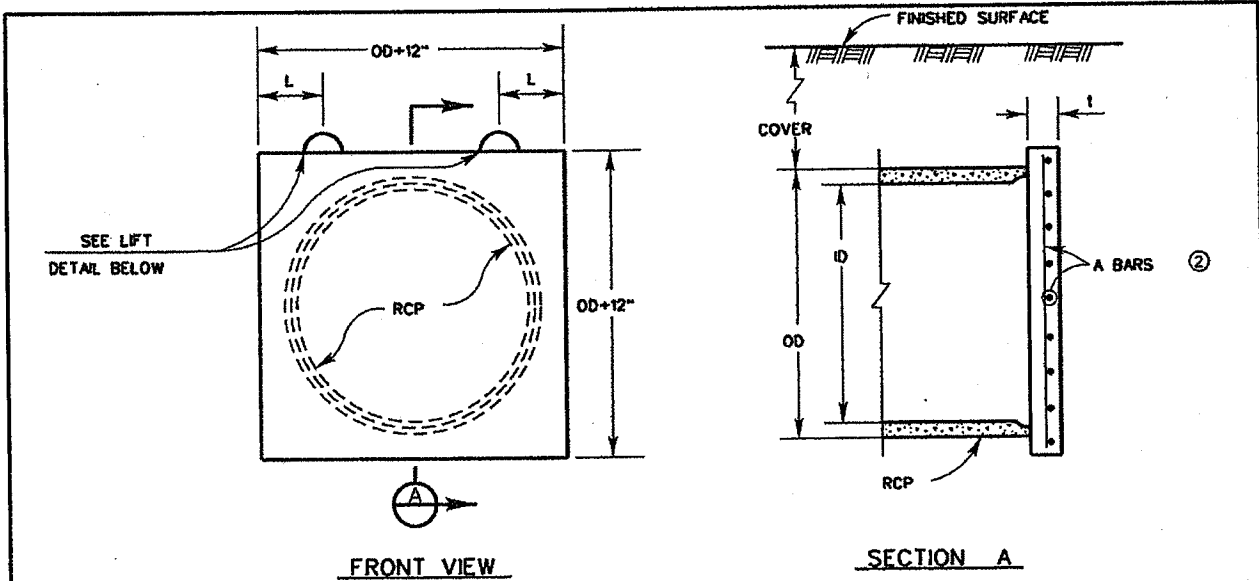

ID (IN)	MAX COVER (FT)	t (IN)	A BARS	L, P
48	5	4	4 @ 9	1'-6"
	10	4	4 @ 6	
	15	5	4 @ 6	
60	5	4	4 @ 6	1'-8"
	10	5	4 @ 6	
	15	5	5 @ 6	
66	5	5	4 @ 6	1'-10"
	10	5	5 @ 6	
	15	5	5 @ 6	
72	5	5	4 @ 6	2'-0"
	10	5	5 @ 6	
	15	5	6 @ 6	
78	5	5	5 @ 6	2'-2"
	10	5	6 @ 6	
	15	6	6 @ 6	
84	5	5	5 @ 6	2'-4"
	10	5	6 @ 6	
	15	6	6 @ 5	
90	5	5	6 @ 6	2'-5"
	10	6	6 @ 6	
	15	6	6 @ 5	
96	5	5	6 @ 6	2'-7"
	10	6	6 @ 5	
	15	6	7 @ 6	

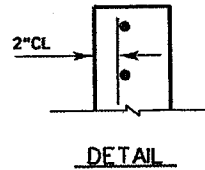
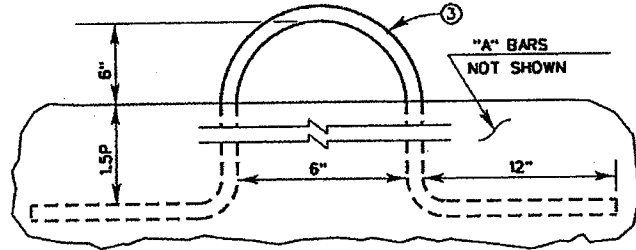

NOTES

1. CONCRETE SHALL BE CLASS 'A'.
2. ALL REINFORCING STEEL SHALL BE CENTERED IN BULKHEAD EXCEPT FOR PIPE DIAMETER GREATER THAN 96", VERTICAL "A" BARS SHALL BE PLACED AT 2" CLEAR FROM THE INSIDE FACE OF THE BULKHEAD. HORIZONTAL "A" BARS SHALL BE PLACED TOWARDS OUTSIDE FACE OF BULKHEAD PER DETAIL.
3. LIFTS SHALL BE WOVEN STEEL CABLE WITH SAME MINIMUM DIAMETER (d) AS "A" BARS. WEAVE CABLE THROUGH HORIZONTAL "A" BARS. COAT EXPOSED PORTION OF CABLE LIFTS WITH AN APPROVED BITUMINOUS PAINT PRIOR TO BACKFILLING TRENCH.



RIVERSIDE COUNTY FLOOD CONTROL AND WATER CONSERVATION DISTRICT

APPROVED BY: *Warren D. Williams*
 CHIEF ENGINEER

DATE: Apr 25, 2004 R.C.E. NO. 32336

CONCRETE BULKHEAD

STANDARD DRAWING NUMBER M816





OFFICE OF
CLERK OF THE BOARD OF SUPERVISORS
1st FLOOR, COUNTY ADMINISTRATIVE CENTER
P.O. BOX 1147, 4080 LEMON STREET
RIVERSIDE, CA 92502-1147
PHONE: (951) 955-1060
FAX: (951) 955-1071

KECIA HARPER-IHEM
Clerk of the Board of Supervisors

KIMBERLY A. RECTOR
Assistant Clerk of the Board

June 7, 2012

THE PRESS ENTERPRISE
ATTN: LEGALS
PO BOX 792
RIVERSIDE, CA 92501

FAX (951) 368-9018
E-MAIL: legals@pe.com

**RE: NOTICE INVITING BIDS: MURRIETA HOT SPRINGS ROAD AND WILLOWS AVENUE
C2-0128**

To Whom It May Concern:

Attached is a copy for publication in your newspaper for **TEN (10) TIMES:**

Monday	- June 11, 2012	Saturday	- June 16, 2012
Tuesday	- June 12, 2012	Sunday	- June 17, 2012
Wednesday	- June 13, 2012	Monday	- June 18, 2012
Thursday	- June 14, 2012	Tuesday	- June 19, 2012
Friday	- June 15, 2012	Wednesday	- June 20, 2012

We require your affidavit of publication immediately upon completion of the last publication.

Your invoice must be submitted to this office in duplicate, WITH TWO CLIPPINGS OF THE PUBLICATION.

NOTE: PLEASE COMPOSE THIS PUBLICATION INTO A SINGLE COLUMN FORMAT.

Thank you in advance for your assistance and expertise.

Sincerely,

Mcgil
Cecilia Gil, Board Assistant to
KECIA HARPER-IHEM, CLERK OF THE BOARD

Gil, Cecilia

From: mtinajero@pe.com on behalf of Master, PEC Legals <legalsmaster@pe.com>
Sent: Thursday, June 07, 2012 11:02 AM
To: Gil, Cecilia
Subject: Re: [Legals] FOR PUBLICATION; Murrieta Hot Springs Road C2-0128

Received for publication from June 11 to June 20

On Thu, Jun 7, 2012 at 10:39 AM, Gil, Cecilia <CCGIL@rcbos.org> wrote:

One more Notice Inviting Bids, for publication from June 11 to 20, 2012. Please confirm. THANK YOU!

Cecilia Gil

Board Assistant to the
Clerk of the Board of Supervisors
951-955-8464

THE COUNTY ADMINISTRATIVE CENTER IS CLOSED EVERY FRIDAY UNTIL FURTHER NOTICE.

PLEASE CONSIDER THE ENVIRONMENT BEFORE PRINTING.

--

Legal Advertising



Publisher of The Press-Enterprise
Phone: 1.800.880.0345
Fax: 951.368.9018

NOTICE INVITING BIDS

County of Riverside, herein called Owner, invites sealed proposals for:

**TRAFFIC SIGNAL AND LIGHTING PROJECT
AT THE INTERSECTION OF
MURRIETA HOT SPRINGS ROAD AND WILLOWS AVENUE**

PROJECT NO. C2-0128

Proposal shall be delivered to the Riverside County Transportation Department, 14th Street Annex, 3525 14th Street, Riverside, California 92501, telephone (951) 955-6780 not later than 2:00 p.m., on Wednesday, June 27, 2012, to be promptly opened in public at said address. Each proposal shall be in accordance with plans, specifications, and other contract documents, dated April 2012, and prepared by County of Riverside, whose address is same as the above, from whom they may be obtained upon deposit of \$35 per set plus mailing. No refund. Prospective bidders may preview the plans, specifications and other contract documents, at no charge prior to purchase, at the above noted location.

The Contractor is required to have a Class "A" license or "C-10" license at the time of bid submission.

Engineering Estimate	\$208,800.00 - \$243,600.00
Bid Bond	10%
Performance Bond	100%
Payment Bond	100%
Working Days	35 Working Days

www.tlma.co.riverside.ca.us/trans

Dated: June 7, 2012

Kecia Harper-Ihem, Clerk of the Board
By: Cecilia Gil, Board Assistant



OFFICE OF
CLERK OF THE BOARD OF SUPERVISORS
1st FLOOR, COUNTY ADMINISTRATIVE CENTER
P.O. BOX 1147, 4080 LEMON STREET
RIVERSIDE, CA 92502-1147
PHONE: (951) 955-1060
FAX: (951) 955-1071

KECIA HARPER-IHEM
Clerk of the Board of Supervisors

KIMBERLY A. RECTOR
Assistant Clerk of the Board

June 7, 2012

THE PRESS ENTERPRISE
ATTN: LEGALS
PO BOX 792
RIVERSIDE, CA 92501

FAX (951) 368-9018
E-MAIL: legals@pe.com

RE: NOTICE INVITING BIDS: BROWN STREET C2-0013

To Whom It May Concern:

Attached is a copy for publication in your newspaper for **TEN (10) TIMES:**

Monday	- June 11, 2012	Saturday	- June 16, 2012
Tuesday	- June 12, 2012	Sunday	- June 17, 2012
Wednesday	- June 13, 2012	Monday	- June 18, 2012
Thursday	- June 14, 2012	Tuesday	- June 19, 2012
Friday	- June 15, 2012	Wednesday	- June 20, 2012

We require your affidavit of publication immediately upon completion of the last publication.

Your invoice must be submitted to this office in duplicate, WITH TWO CLIPPINGS OF THE PUBLICATION.

NOTE: PLEASE COMPOSE THIS PUBLICATION INTO A SINGLE COLUMN FORMAT.

Thank you in advance for your assistance and expertise.

Sincerely,

McGil

Cecilia Gil, Board Assistant to
KECIA HARPER-IHEM, CLERK OF THE BOARD

Gil, Cecilia

From: mtinajero@pe.com on behalf of Master, PEC Legals <legalsmaster@pe.com>
Sent: Thursday, June 07, 2012 11:02 AM
To: Gil, Cecilia
Subject: Re: [Legals] FOR PUBLICATION: Brown Street C2-0013

Received for publication from June 11 to June 20

On Thu, Jun 7, 2012 at 10:38 AM, Gil, Cecilia <CCGIL@rcbos.org> wrote:

Hello! Notice Inviting Bids for publication from June 11 to 20, 2012. Please confirm. THANK YOU!

Cecilia Gil

Board Assistant to the
Clerk of the Board of Supervisors
951-955-8464

THE COUNTY ADMINISTRATIVE CENTER IS CLOSED EVERY FRIDAY UNTIL FURTHER NOTICE.

PLEASE CONSIDER THE ENVIRONMENT BEFORE PRINTING.

--

Legal Advertising



Publisher of The Press-Enterprise
Phone: 1.800.880.0345
Fax: 951.368.9018

NOTICE INVITING BIDS

County of Riverside, herein called Owner, invites sealed proposals for:

**BROWN STREET
LOW WATER CROSSING & STREET IMPROVEMENT PROJECT
FROM SOUDER STREET TO CAJALCO ROAD
MEAD VALLEY AREA**

PROJECT NO. C2-0013

Proposal shall be delivered to the Riverside County Transportation Department, 14th Street Annex, 3525 14th Street, Riverside, California 92501, telephone (951) 955-6780 not later than 2:00 p.m., on Wednesday, June 27, 2012, to be promptly opened in public at said address. Each proposal shall be in accordance with plans, specifications, and other contract documents, dated May 2012, and prepared by County of Riverside, whose address is same as the above, from whom they may be obtained upon deposit of \$30 per set plus mailing. No refund. Prospective bidders may preview the plans, specifications and other contract documents, at no charge prior to purchase, at the above noted location.

The Contractor is required to have a Class "A" license or "C-12" license at the time of bid submission.

Engineering Estimate	\$203,000.00 - \$237,000.00
Bid Bond	10%
Performance Bond	100%
Payment Bond	100%
Working Days	40 Working Days

www.tlma.co.riverside.ca.us/trans

Dated: June 7, 2012

Kecia Harper-Ihem, Clerk of the Board
By: Cecilia Gil, Board Assistant