

**SUBMITTAL TO THE BOARD OF SUPERVISORS
COUNTY OF RIVERSIDE, STATE OF CALIFORNIA**

786A



FROM: TLMA - Transportation Department

SUBMITTAL DATE:
August 16, 2012

SUBJECT: Construction of Brown Street drainage and street improvements from Souder Street to Cajalco Road, Mead Valley area.

RECOMMENDED MOTION: That the Board of Supervisors:

1. Approve two Addenda to the specifications and plans, issued prior to the July 03, 2012 bid opening.
2. Accept the low bid of Panorama General Engineering, Inc. of Rancho Cucamonga, CA in the amount of \$177,466.
3. Award the contract to Panorama General Engineering, Inc. and authorize the Chairman of the Board to execute the contract documents.

Juan C. Perez
Director of Transportation and Land Management

JCP:rrj:rr
(Continued On Attached Pages)

FINANCIAL DATA	Current F.Y. Total Cost:	\$ 177,466	In Current Year Budget:	Yes
	Current F.Y. Net County Cost:	\$ 0	Budget Adjustment:	No
	Annual Net County Cost:	\$ 0	For Fiscal Year:	2012/2013

SOURCE OF FUNDS: Redevelopment Agency (100%)	Positions To Be Deleted Per A-30	<input type="checkbox"/>
	Requires 4/5 Vote	<input type="checkbox"/>

There are no General Funds used in this project.

C.E.O. RECOMMENDATION:

APPROVE

BY:
Tina Grande

County Executive Office Signature

MINUTES OF THE BOARD OF SUPERVISORS

On motion of Supervisor Tavaglione, seconded by Supervisor Buster and duly carried, IT WAS ORDERED that the above matter is approved as recommended.

Ayes: Buster, Tavaglione, Benoit and Ashley
Nays: None
Absent: Stone
Date: August 28, 2012
xc: Tranps.

Kecia Harper-Ihem
Clerk of the Board

By:
Deputy

Prev. Agn. Ref. 6/05/12, Item 3.63 | **District:** 1/1 | **Agenda Number:**

ATTACHMENTS FILED
WITH THE CLERK OF THE BOARD

3.102

FORM APPROVED COUNTY COUNSEL
BY:
MARSHAL VICTOR
DATE: 8/16/12

Departmental Concurrence

Dept't Recomm.: Consent Policy
Per Exec. Ofc.: Consent Policy

The Honorable Board of Supervisors

RE: Construction of Brown Street drainage and street improvements from Souder Street to Cajalco Road, Mead Valley area.

August 16, 2012

Page 2 of 2

BACKGROUND: By Minute Order dated June 5, 2012 (Agenda Item 3.63) the Board authorized the Clerk of the Board to advertise for the construction of Brown Street drainage and street improvements from Souder Street to Cajalco Road, in the Mead Valley area.

During the advertisement period, two addenda were issued to all registered plan holders as a supplement to the specifications and special provisions. Bidders are required to acknowledge and take into account all issued addenda on their Contractor's Proposal in order to be considered for award. The addenda were issued to clarify and modify the approved contract documents. The addenda are attached as Addendum No. 1 and Addendum No. 2.

Bids for the project were opened in the office of the Director of Transportation and Land Management at 2:00 PM, Tuesday, July 3, 2012. Nine bids were received, ranging from \$177,466 to \$261,105. The lowest responsive and responsible bid was submitted by Panorama General Engineering, Inc. of Rancho Cucamonga, CA in the amount of \$177,466, which is \$59,614 (25.2%) below the Engineer's Estimate. The project is expected to be finished within the existing budget as shown on Attachment 'A'.

Project funding is being provided through an agreement between the County and the Redevelopment Agency approved on June 28, 2011 under Agenda Items 3.119 and 4.18.

The low water crossing is located approximately 250 feet south of the intersection of Cajalco Road and Brown Street where Cajalco Creek flows from east to west over the existing asphalt surface. This project will replace the existing Brown Street low water crossing by raising the profile of Brown Street to accommodate the installation of multiple barrel corrugated metal pipe culverts.

The proposed drainage improvements will improve safety by conveying flows under Brown Street and reducing the need for road closures during rain events.

The Contractor is qualified to perform the work as outlined in the bid.

The Contractor has executed the contract and has provided performance and payment bonds, which meet the requirements of the contract.

Project Number: C2-0013

AGREEMENT

THIS AGREEMENT is entered into at Riverside, California as of the date set forth below is between County of Riverside hereafter called "County" and **PANORAMA GENERAL ENGINEERING, INC.** hereafter called "Contractor".

WITNESSETH

RECITALS:

1. Contractor has submitted to County his Contractor's Proposal for the construction of County Project, **Brown Street Low Water Crossing And Street Improvement Project, From Souder Street To Cajalco Road, Mead Valley Area, Project No. C2-0013**, in strict accordance with the Contract Documents identified below and County has accepted said Proposal.
2. Contractor states that he has reexamined his Contractor's Proposal and found it to be correct, has ascertained that his subcontractors are properly licensed and possess the requisite skill and forces, has reexamined the site and Contract Documents and is of the opinion that he can presently do the work in accordance with the Contract Documents for the money set forth in his Proposal to be paid as provided in the Contract Documents.

AGREEMENT:

IT IS AGREED BY THE PARTIES AS FOLLOWS:

1. Contract Documents. The entire contract consists of the following: (a) The Agreement. (b) The Notice Inviting Bids. (c) The Instruction to Bidders. (d) The Contractor's Proposal. (e) The Bid Bond. (f) The Payment Bond. (g) The Performance Bond. (h) The General Conditions. (i) The Special Provisions. (j) The Standard Specifications of the State of California Department of Transportation edition of May 2006 as modified in other portions of the Contract Documents. (k) The Standard Plans of the Department of Transportation identified on the plans or in the Special Provisions. (l) The Plans. (m) Addenda No. **(One, Two)**. (n) The Determination of Prevailing Wage Rates for Public Work. (o) Any Change Orders issued. (p) Any additional or supplemental specifications, notice, instructions and drawings issued in accordance with the provisions of the Contract Documents. All of said Documents presently in existence are by this reference incorporated herein with like effect as if here set forth in full and upon the proper issuance of other documents they shall likewise be deemed incorporated. The Bid Bond is exonerated upon execution of this Agreement and the Payment Bond and Faithful Performance Bond.
2. The Work. Contractor shall do all things necessary to construct the work generally described in Recital No. 1 in accordance with the Contract Documents.

3. Liquidated Damages and Time of Completion. Attention is directed to the provisions in Section 8-1.06, "Time of Completion", and in Section 8-1.07, "Liquidated Damages", of the Standard Specifications and these Special Provisions.

The Contractor shall begin work within 15 days of the date stated within the written "Notice to Proceed".

The Contractor shall notify the Engineer, in writing, of his intent to begin work at least 72 hours before work is begun. The notice shall be delivered to the Transportation Department's Construction Engineer and shall specify the date the Contractor intends to start. If the project has more than one location of work, a separate notice shall be given for each location.

Should the Contractor begin work in advance of receiving a written "Notice to Proceed", any work performed by him in advance of the date stated in the "Notice to Proceed" shall be considered as having been done by him at his own risk and as a volunteer and subject to the following:

- (1) The Contractor shall, on commencing operations, take all precautions required for public safety and shall observe all the provisions in the Specifications and the Special Provisions.
- (2) All work done according to the contract prior to the issuance of the "Notice to Proceed", will be considered authorized work and will be paid for as provided in the contract.
- (3) The Contractor shall not be entitled to any additional compensation or an extension of time for any delay, hindrance or interference caused by or attributable to commencement of work prior to the issuance of the "Notice to Proceed".

4. Compensation. Contractor shall be paid in the manner set forth in the Contract Documents the amount of his Proposal as accepted by County, the above rates, subject to additions and deductions as provided in the Contract Documents. Said Proposal is on file in the Office of the Clerk of the Board of Supervisors of County.

**BROWN STREET
LOW WATER CROSSING AND STREET IMPROVEMENT PROJECT
FROM SOUDER STREET TO CAJALCO ROAD**

PROJECT No. C2-0013

AGREEMENT

ITEM No.	ITEM CODE	ITEM	UNIT	ESTIMATED QUANTITY	ITEM PRICE (IN FIGURES)	TOTAL (IN FIGURES)
BASE BID:						
1	066102	DUST ABATEMENT	LS	1	1,750.00	1,750.00
2	074020	WATER POLLUTION CONTROL	LS	1	3,500.00	3,500.00
3	120100	TRAFFIC CONTROL SYSTEM	LS	1	6,700.00	6,700.00
4	153210	REMOVE CONCRETE	LS	1	1,900.00	1,900.00
5	160101	CLEARING AND GRUBBING	LS	1	600.00	600.00
6	170101	DEVELOP WATER SUPPLY	LS	1	1,625.00	1,625.00
7	190101	ROADWAY EXCAVATION [INCLUDING GRINDING AC PAVEMENT]	CY	280	20.50	5,740.00
8	198001	IMPORTED BORROW	CY	820	13.25	10,865.00
9	260201	CLASS 2 AGGREGATE BASE	CY	262	46.50	12,183.00
10	390132	HOT MIX ASPHALT (TYPE A)	TON	320	93.50	29,920.00
11	193006	STRUCTURE BACKFILL (SLURRY CEMENT)	CY	36	139.50	5,022.00
12	401000	PORTLAND CEMENT CONCRETE PAVEMENT	CY	17	305.00	5,185.00
13	510501	MINOR CONCRETE (HEADWALL & WINGWALL)	CY	10	3,030.00	30,300.00
14	510502	MINOR CONCRETE (MINOR STRUCTURE - PCC DIP SECTION)	CY	62	330.00	20,460.00
15	862065	REPLACE PULL BOX [TRAFFIC BEARING]	EA	2	2,525.00	5,050.00
16	393001	PAVEMENT REINFORCING FABRIC (GEOTEXTILE FABRIC)	SQYD	1,860	3.00	5,580.00
17	566011	ROADSIDE SIGN - ONE POST	EA	6	225.00	1,350.00

AGREEMENT (Continued)

ITEM No.	ITEM CODE	ITEM	UNIT	ESTIMATED QUANTITY	ITEM PRICE (IN FIGURES)	TOTAL (IN FIGURES)
BASE BID:						
18	568017	ROADSIDE SIGN [INSTALL ON EXISTING POST]	EA	2	132.00	264.00
19	667013	28" X 20" CORRUGATED STEEL PIPE ARCH (0.079" THICK)	LF	113	68.00	7,684.00
20	721011	ROCK SLOPE PROTECTION (No.2, METHOD B)	CY	17	180.00	3,060.00
21	729010	ROCK SLOPE PROTECTION FABRIC	SQFT	520	2.65	1,378.00
22	860811	DETECTOR LOOP [REPLACE EXISTING]	EA	4	600.00	2,400.00
23	820107	DELINEATORS (CLASS 1) [SURFACE MOUNTED POST TUBE]	EA	28	37.50	1,050.00
24	840515	THERMOPLASTIC PAVEMENT MARKING	SQFT	150	8.00	1,200.00
25	840501	THERMOPLASTIC TRAFFIC STRIPE	LF	2,000	0.85	1,700.00
26	019901	DE-MOBILIZATION	LS	1	11,000.00	11,000.00

PROJECT

TOTAL: One hundred seventy seven thousand, four hundred sixty six dollars and zero cents **\$177,466.00**

ITEMS 1-26

"WORDS"

IN WITNESS WHEREOF the parties hereto have executed this agreement as of the date set forth below.

COUNTY OF RIVERSIDE

PANORAMA GENERAL ENGINEERING, INC.

BY [Signature]
Chairman, Board of Supervisors
JOHN TAVAGLIONE

BY [Signature]

Dated AUG 28 2012

TITLE: President
(If Corporation, Affix Seal)

ATTEST:

ATTEST:

Kecia Harper-Ihem, Clerk of the Board

[Signature]

BY [Signature]
Deputy

TITLE: VICE PRESIDENT

Licensed in accordance with an act providing for the registration of Contractors,

License No. 937187

Federal Employer Identification Number:

26-4812076

BY _____
"County"
(Seal)

"Corporation"
(Seal)

November 3, 2009

Certificate of Corporate Resolution

I, David L. White, Secretary of Panorama General Engineering, Inc do hereby certify that at a duly constituted meeting of the board of directors and shareholders of the corporation held at 1943 N. Campus Ave, Suite B 466 Upland, CA 91784 on November 02, 2009, it was upon motion and duly made and seconded, that it be voted:

Robert W. Dye, Jr. President/CEO and David L. White Secretary/CFO of the Corporation be empowered to sign and execute any documentation and contracts as a single individual signer as his discretion deems to be in the best interest of the Corporation.

I further certify that the foregoing votes are in full force without rescission, as modification or amendment.

Sincerely,

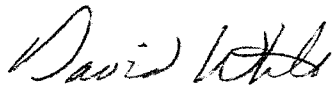

David L. White
Secretary/CFO
Panorama General Engineering, Inc.

PERFORMANCE BOND

Recitals:

1. **PANORAMA GENERAL ENGINEERING, INC.** (Contractor) has entered into an Agreement with COUNTY OF RIVERSIDE (County) for construction of public work known as **Brown Street Low Water Crossing And Street Improvement Project, From Souder Street To Cajalco Road, Mead Valley Area, Project No. C2-0013.**
2. _____, a _____ corporation (Surety), is the Surety under this Bond.

Agreement:

We, Contractor, as Principal, and Surety, as Surety, jointly and severally agree, state, and are bound unto County, as obligee, as follows:

1. The amount of the obligation of this Bond is 100% of the estimated contract price for the Project of \$ **177,466.00 (One hundred seventy seven thousand, four hundred sixty six dollars and zero cents)**, and inures to the benefit of County.
2. This Bond is exonerated by Contractor doing all things to be kept and performed by it in strict conformance with the Contract Documents for the Project, otherwise it remains in full force and effect for the recovery of loss, damage and expense of County resulting from failure of Contractor to so act. All of said Contract Documents are incorporated herein.
3. This obligation is binding on our successors and assigns.
4. For value received, Surety stipulates and agrees that no change, time extension, prepayment to Contractor, alteration or addition to the terms and requirements of the Contract Documents or the work to be performed thereunder shall affect its obligations hereunder and waives notice as to such matters, except the total contract price cannot be increased by more than 10% without approval of Surety.

THIS BOND is executed as of _____.

By _____

By _____

By _____

Type Name _____

Its Attorney in Fact
"Surety"

Title _____

"Contractor"

(Corporate Seal)

(Corporate Seal)

NOTE: This Bond must be executed by both parties with corporate seal affixed. All signatures must be acknowledged. (Attach acknowledgements).

PAYMENT BOND

(Public Work - Civil Code 3247 et seq.)

The makers of this Bond are **PANORAMA GENERAL ENGINEERING, INC.**, as Principal and Original Contractor and _____, a corporation, authorized to issue Surety Bonds in California, as Surety, and this Bond is issued in conjunction with that certain public works contract to be executed between Principal and **COUNTY OF RIVERSIDE** a public entity, as Owner, for \$ **177,466.00 (One hundred seventy seven thousand, four hundred sixty six dollars and zero cents)**, the total amount payable. THE AMOUNT OF THIS BOND IS ONE HUNDRED PERCENT OF SAID SUM. Said contract is for public work generally consisting of **Brown Street Low Water Crossing And Street Improvement Project, From Souder Street To Cajalco Road, Mead Valley Area, Project No. C2-0013.**

The beneficiaries of this Bond are as is stated in 3248 of the Civil Code and requirements and conditions of this Bond are as is set forth in 3248, 3249, 3250 and 3252 of said code. Without notice, Surety consents to extension of time for performance, change in requirements, amount of compensation, or prepayment under said contract.

DATED: _____

Original Contractor - Principal

Surety

By _____

By _____
Its Attorney In Fact

Title _____

(Corporate Seal)

(If corporation, affix seal)

(Corporate Seal)

STATE OF CALIFORNIA
COUNTY OF _____

} ss. SURETY'S ACKNOWLEDGEMENT

On _____ before me, _____ personally appeared, _____, known to me, or proved to me on the basis of satisfactory evidence, to be the person whose name is subscribed to the within instrument and acknowledged to me that he/she executed the same in his/her authorized capacities, and that by his/her signature on the instrument the person, or the entity upon behalf of which the person acted, executed the instrument.

WITNESS my hand and official seal.

Signature of Notary Public

Notary Public (Seal)

NOTE: This Bond must be executed by both parties with corporate seal affixed. All signatures must be acknowledged. (Attach acknowledgements).

PERFORMANCE BOND

Recitals:

1. **PANORAMA GENERAL ENGINEERING, INC.** (Contractor) has entered into an Agreement with COUNTY OF RIVERSIDE (County) for construction of public work known as **Brown Street Low Water Crossing And Street Improvement Project, From Souder Street To Cajalco Road, Mead Valley Area, Project No. C2-0013.**
2. Developers Surety and Indemnity Company, a n _____ Iowa _____ corporation (Surety), is the Surety under this Bond.

Agreement:

We, Contractor, as Principal, and Surety, as Surety, jointly and severally agree, state, and are bound unto County, as obligee, as follows:

1. The amount of the obligation of this Bond is 100% of the estimated contract price for the Project of \$ **177,466.00 (One hundred seventy seven thousand, four hundred sixty six dollars and zero cents)**, and inures to the benefit of County.
2. This Bond is exonerated by Contractor doing all things to be kept and performed by it in strict conformance with the Contract Documents for the Project, otherwise it remains in full force and effect for the recovery of loss, damage and expense of County resulting from failure of Contractor to so act. All of said Contract Documents are incorporated herein.
3. This obligation is binding on our successors and assigns.
4. For value received, Surety stipulates and agrees that no change, time extension, prepayment to Contractor, alteration or addition to the terms and requirements of the Contract Documents or the work to be performed thereunder shall affect its obligations hereunder and waives notice as to such matters, except the total contract price cannot be increased by more than 10% without approval of Surety.

THIS BOND is executed as of July 25, 2012

By _____

By  _____
Robert W. Dye, Jr

Title President
"Contractor"

(Corporate Seal)

By  _____

Type Name Scott Edward Pulido
Its Attorney in Fact
"Surety"

(Corporate Seal)

NOTE: This Bond must be executed by both parties with corporate seal affixed. All signatures must be acknowledged. (Attach acknowledgements).

CALIFORNIA ALL-PURPOSE ACKNOWLEDGMENT

CIVIL CODE § 1189

State of California

County of San Bernardino

On July 25, 2012 before me, Cathryn A. Yeager, Notary Public

personally appeared Robert W. Dye, Jr.

who proved to me on the basis of satisfactory evidence to be the person(s) whose name(s) is/are subscribed to the within instrument and acknowledged to me that he/she/they executed the same in his/her/their authorized capacity(ies), and that by his/her/their signature(s) on the instrument the person(s), or the entity upon behalf of which the person(s) acted, executed the instrument.

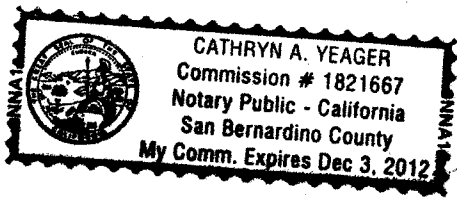

I certify under PENALTY OF PERJURY under the laws of the State of California that the foregoing paragraph is true and correct.

WITNESS my hand and official seal. Signature: Cathryn A. Yeager

OPTIONAL Though the information below is not required by law, it may prove valuable to persons relying on the document and could prevent fraudulent removal and reattachment of this form to another document.

Description of Attached Document

Title or Type of Document:

Document Date: Number of Pages:

Signer(s) Other Than Named Above:

Capacity(ies) Claimed by Signer(s)

Signer's Name: Signer's Name:

- Corporate Officer - Title(s): Individual Partner - Limited General Attorney in Fact Trustee Guardian or Conservator Other:

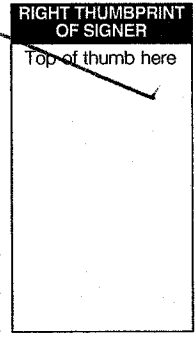
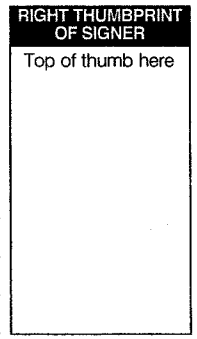

Signer Is Representing: Signer Is Representing:

CALIFORNIA ALL-PURPOSE ACKNOWLEDGMENT

CIVIL CODE § 1189

State of California

County of San Bernardino }

On July 25, 2012 before me, Cathryn A Yeager, Notary Public

personally appeared Scott Edward Lucido Name(s) of Signer(s)

who proved to me on the basis of satisfactory evidence to be the person(s) whose name(s) is/are subscribed to the within instrument and acknowledged to me that he/she/they executed the same in his/her/their authorized capacity(ies), and that by his/her/their signature(s) on the instrument the person(s), or the entity upon behalf of which the person(s) acted, executed the instrument.

I certify under PENALTY OF PERJURY under the laws of the State of California that the foregoing paragraph is true and correct.

WITNESS my hand and official seal.

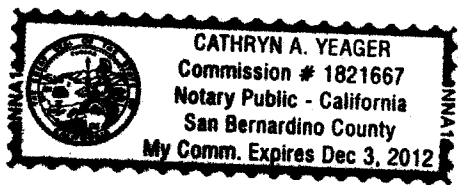

Place Notary Seal Above

Signature: Cathryn A. Yeager Signature of Notary Public

OPTIONAL

Though the information below is not required by law, it may prove valuable to persons relying on the document and could prevent fraudulent removal and reattachment of this form to another document.

Description of Attached Document

Title or Type of Document:

Document Date: Number of Pages:

Signer(s) Other Than Named Above:

Capacity(ies) Claimed by Signer(s)

Signer's Name: Signer's Name:

Corporate Officer -- Title(s): Corporate Officer -- Title(s):

Individual Individual

Partner -- Limited General Partner -- Limited General

Attorney in Fact Attorney in Fact

Trustee Trustee

Guardian or Conservator Guardian or Conservator

Other: Other:

Signer Is Representing: Signer Is Representing:

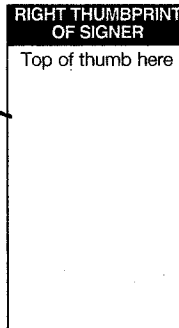
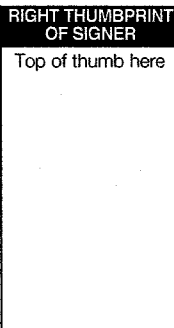

POWER OF ATTORNEY FOR
DEVELOPERS SURETY AND INDEMNITY COMPANY
INDEMNITY COMPANY OF CALIFORNIA
PO Box 19725, IRVINE, CA 92623 (949) 263-3300

KNOW ALL BY THESE PRESENTS that except as expressly limited, DEVELOPERS SURETY AND INDEMNITY COMPANY and INDEMNITY COMPANY OF CALIFORNIA, do each hereby make, constitute and appoint: ***Scott Edward Pulido***

as their true and lawful Attorney(s)-in-Fact, to make, execute, deliver and acknowledge, for and on behalf of said corporations, as sureties, bonds, undertakings and contracts of suretyship giving and granting unto said Attorney(s)-in-Fact full power and authority to do and to perform every act necessary, requisite or proper to be done in connection therewith as each of said corporations could do, but reserving to each of said corporations full power of substitution and revocation, and all of the acts of said Attorney(s)-in-Fact, pursuant to these presents, are hereby ratified and confirmed.

This Power of Attorney is granted and is signed by facsimile under and by authority of the following resolutions adopted by the respective Boards of Directors of DEVELOPERS SURETY AND INDEMNITY COMPANY and INDEMNITY COMPANY OF CALIFORNIA, effective as of January 1st, 2008.

RESOLVED, that a combination of any two of the Chairman of the Board, the President, Executive Vice-President, Senior Vice-President or any Vice President of the corporations be, and that each of them hereby is, authorized to execute this Power of Attorney, qualifying the attorney(s) named in the Power of Attorney to execute, on behalf of the corporations, bonds, undertakings and contracts of suretyship; and that the Secretary or any Assistant Secretary of either of the corporations be, and each of them hereby is, authorized to attest the execution of any such Power of Attorney;

RESOLVED, FURTHER, that the signatures of such officers may be affixed to any such Power of Attorney or to any certificate relating thereto by facsimile, and any such Power of Attorney or certificate bearing such facsimile signatures shall be valid and binding upon the corporations when so affixed and in the future with respect to any bond, undertaking or contract of suretyship to which it is attached.

IN WITNESS WHEREOF, DEVELOPERS SURETY AND INDEMNITY COMPANY and INDEMNITY COMPANY OF CALIFORNIA have severally caused these presents to be signed by their respective officers and attested by their respective Secretary or Assistant Secretary this October 4th, 2011.

By: Daniel Young
Daniel Young, Senior Vice-President

By: Steve A. Tvedt
Steve A. Tvedt, Vice-President



State of California
County of Orange

On October 4, 2011 before me, Antonio Alvarado, Notary Public
Date Here Insert Name and Title of the Officer

personally appeared Daniel Young and Steve A. Tvedt
Name(s) of Signer(s)

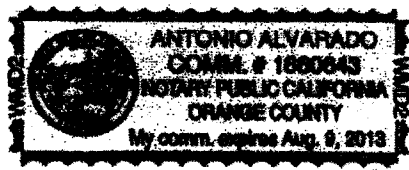

Place Notary Seal Above

who proved to me on the basis of satisfactory evidence to be the person(s) whose name(s) is/are subscribed to the within instrument and acknowledged to me that he/she/they executed the same in his/her/their authorized capacity(ies), and that by his/her/their signature(s) on the instrument the person(s), or the entity upon behalf of which the person(s) acted, executed the instrument.

I certify under PENALTY OF PERJURY under the laws of the State of California that the foregoing paragraph is true and correct.

WITNESS my hand and official seal.
Signature Antonio Alvarado
Antonio Alvarado, Notary Public

CERTIFICATE

The undersigned, as Secretary or Assistant Secretary of DEVELOPERS SURETY AND INDEMNITY COMPANY or INDEMNITY COMPANY OF CALIFORNIA, does hereby certify that the foregoing Power of Attorney remains in full force and has not been revoked and, furthermore, that the provisions of the resolutions of the respective Boards of Directors of said corporations set forth in the Power of Attorney are in force as of the date of this Certificate.

This Certificate is executed in the City of Irvine, California, this _____ day of _____

By: Gregg Okura
Gregg Okura, Assistant Secretary

Company Profile

DEVELOPERS SURETY AND INDEMNITY COMPANY

17771 COWAN, SUITE 100
IRVINE, CA 92614

Agent for Service of Process
SUSAN M. MOORE, 17771 COWAN SUITE 100 IRVINE, CA 92614
Unable to Locate the Agent for Service of Process?

Reference Information

NAIC #:	12718
NAIC Group #:	<u>0075</u>
California Company ID #:	4606-0
Date authorized in California:	August 30, 1999
License Status:	UNLIMITED-NORMAL
Company Type:	Property & Casualty
State of Domicile:	IOWA

Lines of Insurance Authorized to Transact

The company is authorized to transact business within these lines of insurance. For an explanation of any of these terms, please refer to the glossary.

AUTOMOBILE
BOILER AND MACHINERY
BURGLARY
FIRE
LEGAL INSURANCE
LIABILITY
MARINE
MISCELLANEOUS
PLATE GLASS
SPRINKLER
SURETY

Company Complaint Information

[Company Enforcement Action Documents](#)
[Company Performance & Comparison Data](#)
[Composite Complaint Studies](#)

Want More?

[Help Me Find a Company Representative in My Area](#)

Last Revised - June 05, 2012 12:07 PM
Copyright © California Department of Insurance

THIS BOND WAS EXECUTED
IN TWO IDENTICAL COUNTERPARTS

PAYMENT BOND

PREMIUM INCLUDED IN
PERFORMANCE BOND
BOND NO. 351641p

(Public Work - Civil Code 3247 et seq.)

The makers of this Bond are **PANORAMA GENERAL ENGINEERING, INC.**, as Principal and Original Contractor and Developers Surety and Indemnity Company, a corporation, authorized to issue Surety Bonds in California, as Surety, and this Bond is issued in conjunction with that certain public works contract to be executed between Principal and **COUNTY OF RIVERSIDE** a public entity, as Owner, for \$ **177,466.00 (One hundred seventy seven thousand, four hundred sixty six dollars and zero cents)**, the total amount payable. THE AMOUNT OF THIS BOND IS ONE HUNDRED PERCENT OF SAID SUM. Said contract is for public work generally consisting of **Brown Street Low Water Crossing And Street Improvement Project, From Souder Street To Cajalco Road, Mead Valley Area, Project No. C2-0013.**

The beneficiaries of this Bond are as is stated in 3248 of the Civil Code and requirements and conditions of this Bond are as is set forth in 3248, 3249, 3250 and 3252 of said code. Without notice, Surety consents to extension of time for performance, change in requirements, amount of compensation, or prepayment under said contract.

DATED: July 25, 2012

Panorama General Engineering, Inc
Original Contractor - Principal

Developers Surety and Indemnity Company
Surety

By 
Robert W. Dye, Jr

By 
Its Attorney In Fact
Scott Edward Pulido

Title President

(If corporation, affix seal)

(Corporate Seal)

(Corporate Seal)

STATE OF CALIFORNIA
COUNTY OF _____

} ss. SURETY'S ACKNOWLEDGEMENT

On _____ before me, _____ personally appeared, _____, known to me, or proved to me on the basis of satisfactory evidence, to be the person whose name is subscribed to the within instrument and acknowledged to me that he/she executed the same in his/her authorized capacities, and that by his/her signature on the instrument the person, or the entity upon behalf of which the person acted, executed the instrument.

WITNESS my hand and official seal.

Signature of Notary Public

Notary Public (Seal)

NOTE: This Bond must be executed by both parties with corporate seal affixed. All signatures must be acknowledged. (Attach acknowledgements).

CALIFORNIA ALL-PURPOSE ACKNOWLEDGMENT

CIVIL CODE § 1189

State of California

County of San Bernardino

On July 25, 2012 before me, Cathryn A. Yeager Notary Public

personally appeared Robert W. Ryan

who proved to me on the basis of satisfactory evidence to be the person(s) whose name(s) is/are subscribed to the within instrument and acknowledged to me that he/she/they executed the same in his/her/their authorized capacity(ies), and that by his/her/their signature(s) on the instrument the person(s), or the entity upon behalf of which the person(s) acted, executed the instrument.



I certify under PENALTY OF PERJURY under the laws of the State of California that the foregoing paragraph is true and correct.

WITNESS my hand and official seal.

Signature: Cathryn A. Yeager

Place Notary Seal Above

OPTIONAL

Though the information below is not required by law, it may prove valuable to persons relying on the document and could prevent fraudulent removal and reattachment of this form to another document.

Description of Attached Document

Title or Type of Document:

Document Date: Number of Pages:

Signer(s) Other Than Named Above:

Capacity(ies) Claimed by Signer(s)

Signer's Name: Signer's Name:

- Corporate Officer -- Title(s):
Individual
Partner -- Limited General
Attorney in Fact
Trustee
Guardian or Conservator
Other:

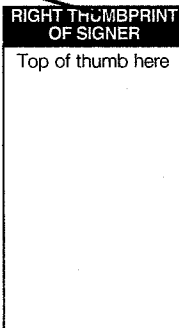
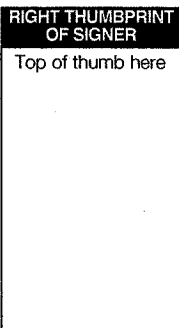

Signer Is Representing:

Signer Is Representing:

**POWER OF ATTORNEY FOR
DEVELOPERS SURETY AND INDEMNITY COMPANY
INDEMNITY COMPANY OF CALIFORNIA
PO Box 19725, IRVINE, CA 92623 (949) 263-3300**

KNOW ALL BY THESE PRESENTS that except as expressly limited, DEVELOPERS SURETY AND INDEMNITY COMPANY and INDEMNITY COMPANY OF CALIFORNIA, do each hereby make, constitute and appoint: ***Scott Edward Pulido***

as their true and lawful Attorney(s)-in-Fact, to make, execute, deliver and acknowledge, for and on behalf of said corporations, as sureties, bonds, undertakings and contracts of suretyship giving and granting unto said Attorney(s)-in-Fact full power and authority to do and to perform every act necessary, requisite or proper to be done in connection therewith as each of said corporations could do, but reserving to each of said corporations full power of substitution and revocation, and all of the acts of said Attorney(s)-in-Fact, pursuant to these presents, are hereby ratified and confirmed.

This Power of Attorney is granted and is signed by facsimile under and by authority of the following resolutions adopted by the respective Boards of Directors of DEVELOPERS SURETY AND INDEMNITY COMPANY and INDEMNITY COMPANY OF CALIFORNIA, effective as of January 1st, 2008.

RESOLVED, that a combination of any two of the Chairman of the Board, the President, Executive Vice-President, Senior Vice-President or any Vice President of the corporations be, and that each of them hereby is, authorized to execute this Power of Attorney, qualifying the attorney(s) named in the Power of Attorney to execute, on behalf of the corporations, bonds, undertakings and contracts of suretyship; and that the Secretary or any Assistant Secretary of either of the corporations be, and each of them hereby is, authorized to attest the execution of any such Power of Attorney;

RESOLVED, FURTHER, that the signatures of such officers may be affixed to any such Power of Attorney or to any certificate relating thereto by facsimile, and any such Power of Attorney or certificate bearing such facsimile signatures shall be valid and binding upon the corporations when so affixed and in the future with respect to any bond, undertaking or contract of suretyship to which it is attached.

IN WITNESS WHEREOF, DEVELOPERS SURETY AND INDEMNITY COMPANY and INDEMNITY COMPANY OF CALIFORNIA have severally caused these presents to be signed by their respective officers and attested by their respective Secretary or Assistant Secretary this October 4th, 2011.

By: *Daniel Young*
Daniel Young, Senior Vice-President

By: *Steve A. Tvedt*
Steve A. Tvedt, Vice-President



State of California
County of Orange

On October 4, 2011 before me, Antonio Alvarado, Notary Public
Date Here Insert Name and Title of the Officer

personally appeared Daniel Young and Steve A. Tvedt
Name(s) of Signer(s)

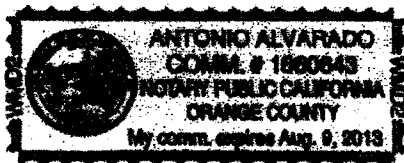

Place Notary Seal Above

who proved to me on the basis of satisfactory evidence to be the person(s) whose name(s) is/are subscribed to the within instrument and acknowledged to me that he/she/they executed the same in his/her/their authorized capacity(ies), and that by his/her/their signature(s) on the instrument the person(s), or the entity upon behalf of which the person(s) acted, executed the instrument.

I certify under PENALTY OF PERJURY under the laws of the State of California that the foregoing paragraph is true and correct.

WITNESS my hand and official seal.

Signature *Antonio Alvarado*
Antonio Alvarado, Notary Public

CERTIFICATE

The undersigned, as Secretary or Assistant Secretary of DEVELOPERS SURETY AND INDEMNITY COMPANY or INDEMNITY COMPANY OF CALIFORNIA, does hereby certify that the foregoing Power of Attorney remains in full force and has not been revoked and, furthermore, that the provisions of the resolutions of the respective Boards of Directors of said corporations set forth in the Power of Attorney are in force as of the date of this Certificate.

This Certificate is executed in the City of Irvine, California, this _____ day of _____

By: *Gregg Okura*
Gregg Okura, Assistant Secretary

Company Profile

DEVELOPERS SURETY AND INDEMNITY COMPANY

17771 COWAN, SUITE 100
IRVINE, CA 92614

Agent for Service of Process
SUSAN M. MOORE, 17771 COWAN SUITE 100 IRVINE, CA 92614
Unable to Locate the Agent for Service of Process?

Reference Information

NAIC #:	12718
NAIC Group #:	0075
California Company ID #:	4606-0
Date authorized in California:	August 30, 1999
License Status:	UNLIMITED-NORMAL
Company Type:	Property & Casualty
State of Domicile:	IOWA

Lines of Insurance Authorized to Transact

The company is authorized to transact business within these lines of insurance. For an explanation of any of these terms, please refer to the glossary.

AUTOMOBILE
BOILER AND MACHINERY
BURGLARY
FIRE
LEGAL INSURANCE
LIABILITY
MARINE
MISCELLANEOUS
PLATE GLASS
SPRINKLER
SURETY

Company Complaint Information

[Company Enforcement Action Documents](#)
[Company Performance & Comparison Data](#)
[Composite Complaint Studies](#)

Want More?

[Help Me Find a Company Representative in My Area](#)

Last Revised - June 05, 2012 12:07 PM
Copyright © California Department of Insurance

Attachment "A"

Riverside County Transportation Department

Project: **Brown St @ S'Iy Cajalco Rd**

Project No.(s): **C2-0013**

PROJECT BUDGET AND EXPENSES

ACTIVITY	EXPENSES			BUDGET
	INCURRED	PROJECTED	TOTAL	EXISTING
Preliminary Survey	9,000	6,000	15,000	5,000
Environmental	12,000	13,000	25,000	12,000
Design	40,000	15,000	55,000	65,000
Right-of-way				
Utilities				
Construction		177,466	177,466	333,000
Construction Contingency	10.0%	22,545	22,545	
Construction Engineering & Inspection	42.3%	75,000	75,000	50,000
Construction Survey	14.1%	25,000	25,000	35,000
Totals:	61,000	334,011	395,011	500,000

PROJECT FUNDING

CODE	NAME	BUDGET
		EXISTING
332	Redevelopment Agency	500,000
Totals		500,000

COMMENTS

**C O U N T Y O F R I V E R S I D E
D E P A R T M E N T O F T R A N S P O R T A T I O N**

**BROWN STREET
LOW WATER CROSSING
& STREET IMPROVEMENT PROJECT
FROM SOUDER STREET TO CAJALCO ROAD
MEAD VALLEY AREA
PROJECT NO. C2-0013**

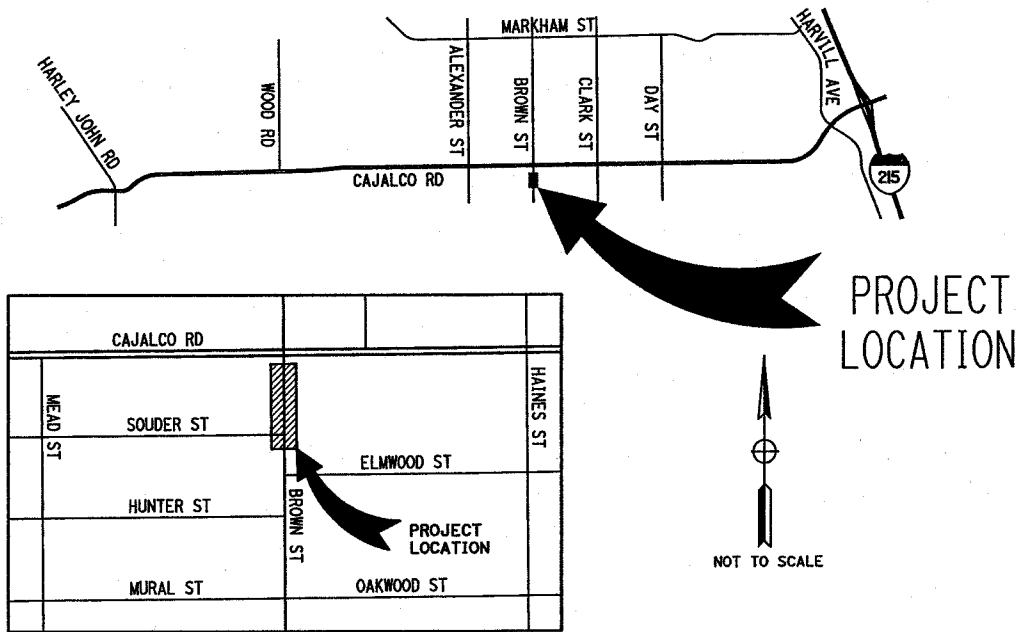
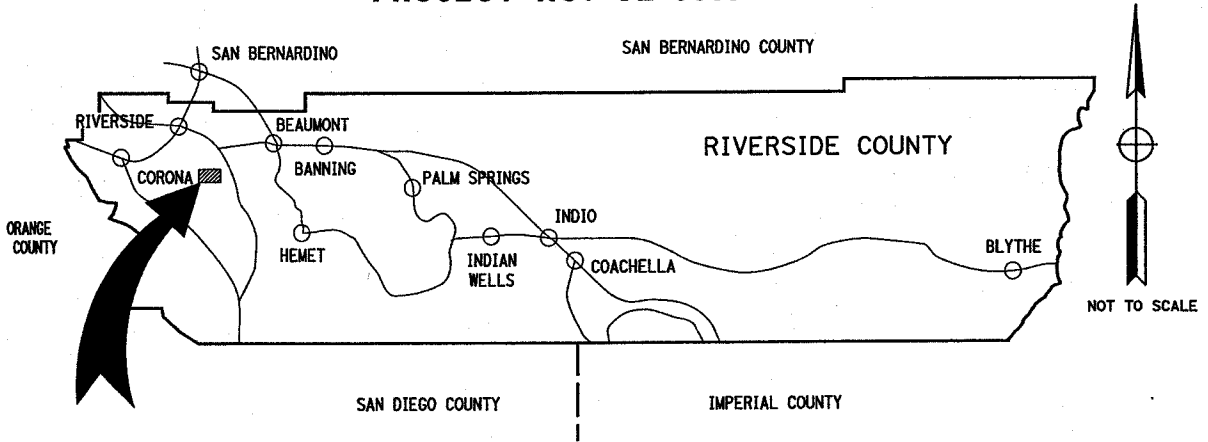

VICINITY MAP

PROJECT LENGTH = 0.08 MILES
SECTION 9, 10 TOWNSHIP 48 RANGE 4W
2011 THOMAS GUIDE PG 776, H-3

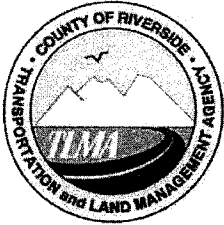

COUNTY OF RIVERSIDE TRANSPORTATION AND LAND MANAGEMENT AGENCY



Juan C. Perez, P.E., T.E.
Director of Transportation

Transportation Department

ADDENDUM NUMBER 1

Dated June 5, 2012

to the
Specifications and Contract Documents
for the construction of

Brown Street
Low Water Crossing and Street Improvement

Project No. C2-0013

Bids Due: Wednesday, June 27, 2012; 2:00 PM
14th Street Transportation Annex
3525 14th Street, Riverside, CA 92501
(951) 955-6780

This Addendum is issued pursuant to the Instructions to Bidders, Item No. 8, of the Contract Documents for the reference project. This Addendum is issued as a supplement to the specification and special provisions for the referenced project. The revisions to the specifications shall become a part of the Contract Documents, and each bidder shall acknowledge receipt thereof on the Contractor's Proposal. Bidders are directed to sign this addendum as acknowledged, and attach the signed addendum to the contractor's submitted proposal.

Note: During the advertisement period of this project, this document and attachments (if any) are available upon request at the office of the Transportation Department, and are available as a free download at the Transportation Department's website:

http://www.rctlma.org/trans/con_bid_advertisements.html

MODIFICATIONS / CLARIFICATIONS TO SPECIAL PROVISIONS:

Item 1: Revised Proposal.

Refer to "Proposal" page B3. Proposal (page B3) is deleted and replaced with revised "Proposal" attached herewith as **Attachment "A"**. The following changes have been made to the Proposal Schedule:

- a. The following bid items descriptions have been revised:
 - Item 20, ROCK SLOPE PROTECTION (No. 2, METHOD B)
- b. "Estimated Quantities" are revised from the following bid items:
 - Item 8, IMPORTED BORROW
 - Item 9, CLASS 2 AGGREGATE BASE

See Attachment "A", Revised Proposal

MODIFICATIONS / CLARIFICATIONS TO THE PLANS:

Item 2: ROCK SLOPE PROTECTION revision.

Refer to "ROCK SLOPE PROTECTION" detail on Sheet No. X-1 (Sheet 2 of 6).

Delete the following note on the detail:

ROCK SLOPE PROTECTION BACKING NO. 2, METHOD B

and replace it with the following note:

ROCK SLOPE PROTECTION, NO. 2, METHOD B

Item 3: SAWCUT LONGITUDINAL AND TRANSVERSE JOINTS ON CONCRETE SURFACES revision.

Refer to plans sheet C-1 (Sheet 4 of 6), between Sta 20+40 and Sta 21+09 additional Sawcut Joints will be required as follows:

Up to 4 additional Transverse Sawcut Joints are required.

2 additional Longitudinal Sawcut Joints are required.

Locations of Sawcut Joints will be determined in the field as directed by the Resident Engineer.

Item 4: PCC DIP SECTION revision.

Refer to "PCC DIP SECTION" detail on Sheet No. C-2 (Sheet 5 of 6).

Delete the following notes on the detail:

COMPACTED SUBGRADE

and replace with the following note:

0.5' CLASS 2 AGGREGATE BASE OVER COMPACTED SUBGRADE

Item 5: REINFORCEMENT OVER CORRUGATED METAL PIPE ARCH CULVERT revision.

Refer to "SECTION A-A" and "SECTION B-B" details on Sheet No. C-2 (Sheet 5 of 6).

Delete the following note on the details pertaining to steel reinforcement:

#4 @ 18" MAX

and replace with the following note:

#4 @ 12" MAX Long.

#4 @ 18" MAX Trans.

This addendum has been prepared under the direction of the following registered Civil Engineer(s):

Civil Engineering Only

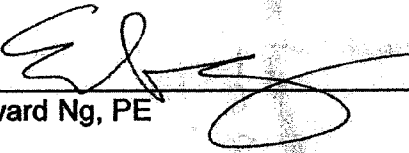

Edward Ng, PE

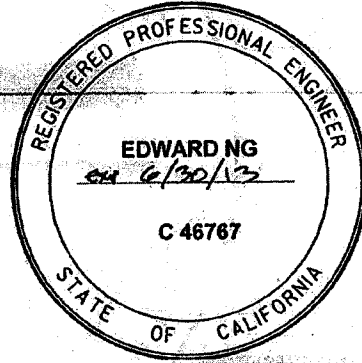

Recommended by:



Scott Staley, PE
County Project Manager

Concurrence:

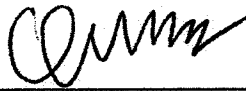

Khalid Nasim, PE
Engineering Division Manager

Acknowledged: _____ **Date:** _____
(Contractor)

JRJ:jj:rr

ATTACHMENTS

A – Revised Proposal

**BROWN STREET
LOW WATER CROSSING AND STREET IMPROVEMENT PROJECT
FROM SOUDER STREET TO CAJALCO ROAD
MEAD VALLEY AREA**

PROJECT NO. C2-0013

PROPOSAL (Revised by Addendum No. 1)

ITEM No.	ITEM CODE	ITEM	UNIT	ESTIMATED QUANTITY	ITEM PRICE (IN FIGURES)	TOTAL (IN FIGURES)
1	066102	DUST ABATEMENT	LS	1		
2	074020	WATER POLLUTION CONTROL	LS	1		
3	120100	TRAFFIC CONTROL SYSTEM	LS	1		
4	153210	REMOVE CONCRETE	LS	1		
5	160101	CLEARING AND GRUBBING	LS	1		
6	170101	DEVELOP WATER SUPPLY	LS	1		
7	190101	ROADWAY EXCAVATION [INCLUDING GRINDING AC PAVEMENT]	CY	280		
8	198001	IMPORTED BORROW	CY	820		
9	260201	CLASS 2 AGGREGATE BASE	CY	262		
10	390132	HOT MIX ASPHALT (TYPE A)	TON	320		
11	193006	STRUCTURE BACKFILL (SLURRY CEMENT)	CY	36		
12	401000	PORTLAND CEMENT CONCRETE PAVEMENT	CY	17		
13	510501	MINOR CONCRETE (HEADWALL & WINGWALL)	CY	10		
14	510502	MINOR CONCRETE (MINOR STRUCTURE - PCC DIP SECTION)	CY	62		
15	862065	REPLACE PULL BOX [TRAFFIC BEARING]	EA	2		
16	393001	PAVEMENT REINFORCING FABRIC (GEOTEXTILE FABRIC)	SQYD	1,860		
17	566011	ROADSIDE SIGN - ONE POST	EA	6		
18	568017	ROADSIDE SIGN [INSTALL ON EXISTING POST]	EA	2		
19	667013	28" X 20" CORRUGATED STEEL PIPE ARCH (0.079" THICK)	LF	113		
20	721011	ROCK SLOPE PROTECTION (NO.2, METHOD B)	CY	17		
21	729010	ROCK SLOPE PROTECTION FABRIC	SQFT	520		
22	860811	DETECTOR LOOP [REPLACE EXISTING]	EA	4		
23	820107	DELINEATORS (CLASS 1) [SURFACE MOUNTED POST TUBE]	EA	28		
24	840515	THERMOPLASTIC PAVEMENT MARKING	SQFT	150		
25	840501	THERMOPLASTIC TRAFFIC STRIPE	LF	2,000		
26	019901	DE-MOBILIZATION	LS	1	11,000.00	11,000.00

PROJECT TOTAL: _____ \$ _____

ITEMS 1-26

"WORDS"



COUNTY OF RIVERSIDE TRANSPORTATION AND LAND MANAGEMENT AGENCY



Juan C. Perez, P.E., T.E.
Director of Transportation

Transportation Department

ADDENDUM NUMBER 2

Dated June 26, 2012

to the
Specifications and Contract Documents
for the construction of

Brown Street
Low Water Crossing and Street Improvement

Project No. C2-0013

Bids Due: **(REVISED)**
Tuesday, July 03, 2012; 2:00 PM
14th Street Transportation Annex
3525 14th Street; Riverside, CA 92501
(951) 955-6780

This Addendum is issued pursuant to the Instructions to Bidders, Item No. 8, of the Contract Documents for the reference project. This Addendum is issued as a supplement to the specification and special provisions for the referenced project. The revisions to the specifications shall become a part of the Contract Documents, and each bidder shall acknowledge receipt thereof on the Contractor's Proposal. Bidders are directed to sign this addendum as acknowledged, and attach the signed addendum to the contractor's submitted proposal.

Note: During the advertisement period of this project, this document and attachments (if any) are available upon request at the office of the Transportation Department, and are available as a free download at the Transportation Department's website:

http://www.rctlma.org/trans/con_bid_advertisements.html

MODIFICATIONS / CLARIFICATIONS TO SPECIAL PROVISIONS:

Item 1: The new designated date and time for the receipt and opening of bids is revised as follows:

Tuesday, July 03, 2012; 2:00 PM
14th Street Transportation Annex
3525 14th Street; Riverside, CA 92501
(951) 955-6780

Item 2: Clarification of Road Closure for Brown Street and Detour Plan. Refer to section "TRAFFIC CONTROL SYSTEM" on pages 51 through 53, and "LIQUIDATED DAMAGES" on page 50.

Full closure of Brown Street between the project limits will be allowed for a period of 30 consecutive Calendar Days within the 40 Working Days established for project completion.

Detour Plan for Brown Street. The following special provision for "Detour Plan" is added and made part here of:

DETOUR PLAN:

The awarded Contractor shall provide detour plans in accordance with the "Traffic Control System" and "Maintaining Traffic" specifications. The plan shall provide necessary information regarding the required signs and their locations. The work included in this item shall include supplying all labor, materials, equipment, supervision, and incidentals required to implement, monitor, and maintain the detour route(s) as shown on the Detour Plan.

The Contractor's responsibility shall include, but not limited to, traffic signs, special signs, portable changeable message signs, barricades, type III barricades, changing internally illuminated street name panel, changing street name sign plates, delineators, and other incidental items for the detour.

The Contractor shall be responsible for implementing, monitoring, and maintaining the detour route(s) until the acceptance of the project.

Forty-eight hours prior to implementing the detour, the Contractor shall be responsible for contacting the County Traffic Signal Maintenance Division at (951) 955-6894. Contractor shall coordinate all modifications to adjacent signals with the Signal Maintenance Division. Contact person within the Signal Maintenance Division is Delaney Davezan.

Full compensation for the Detour Plan shall include all labor, materials, tools, equipment and incidentals, and for doing all work involved in furnishing, placing, operating, maintaining, repairing, and transporting items as directed by the Engineer and shall be considered as included in the Lump Sum price paid for Traffic Control System and no additional compensation will be allowed therefor.

Item 3: Portable Changeable Message Signs

The following special provision for "Portable Changeable Message Signs" is added and made part here of:

PORTABLE CHANGEABLE MESSAGE SIGNS:

A minimum of three (3) portable changeable message signs shall be furnished, placed, operated, and maintained at locations shown on the plans or where designated by the Engineer and shall conform to the provisions in Section 12, "Construction Area Traffic Control Devices" of the Standard Specifications and these special provisions. Messages displayed on the portable changeable message signs shall be provided to the contractor by the Engineer at the preconstruction meeting and shall conform to Section

12-3.12 "Portable Changeable Message Signs" of the Standard Specifications and "Maintaining Traffic" of these special provisions.

A portable changeable message sign shall be placed in advance of the first warning sign for each stationary lane closure. Additionally, portable changeable message signs shall be placed before road closures.

Full compensation for portable changeable message signs shall include all labor, materials, tools, equipment and incidentals, and for doing all work involved in furnishing, placing, operating, maintaining, repairing, transporting from location to location and removing portable changeable message signs as directed by the Engineer, and shall be considered as included in the lump sum price paid for Traffic Control System and no additional compensation will be allowed therefor.

Item 4: Clarification of Dust Control Sign. Refer to GENERAL CONDITIONS, Section 23, "DUST ABATEMENT" on pages 18 through 21, and AQMD RECOMMENDATIONS on pages 22 through 47.

The Contractor shall furnish and post one dust mitigation sign, which shall be, at a minimum, in accordance with the AQMD Recommendations.

Item 5: Clarification of Roadside Signs. Refer to section "ROADSIDE SIGN" on page 80.

County Standards No. 1221 and 1222 mentioned on the second paragraph are provided and attached herewith as **Attachment "A"** for reference.

Item 6: Revision Replace Traffic Bearing Pull Box. Refer to section "REPLACE TRAFFIC BEARING PULL BOX" on page 84. The last paragraph is deleted and replaced with the following:

"Full compensation for furnishing all labor, materials, tools and equipment and for doing all the work involved in replacing existing pull boxes with traffic bearing pull boxes, **including new conduit extensions, loop stub-out, sweeps, and adjustment of existing conduit to accommodate new pull boxes to new grade**, as shown on the plans and specified in these Special Provisions shall be considered as included in the contract unit bid price paid per each for Replace Pull Box [Traffic Bearing] and no additional compensation will be allowed therefor."

This addendum has been prepared under the direction of the following registered Civil Engineer(s):

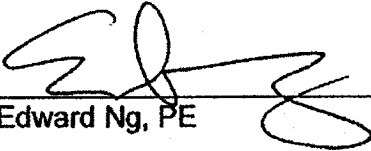

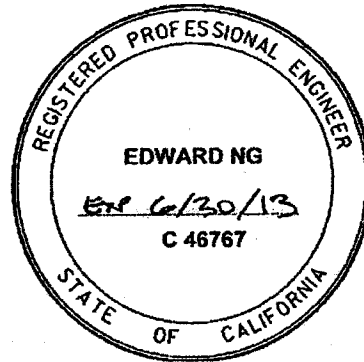
Edward Ng, PE



Recommended by:

Scott Staley, PE
County Project Manager

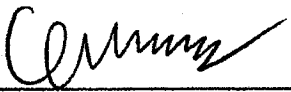
Concurrence:



Khalid Nasim, PE
Engineering Division Manager

Acknowledged: _____ **Date:** _____
(Contractor)

JRJ:jj:rr

ATTACHMENTS

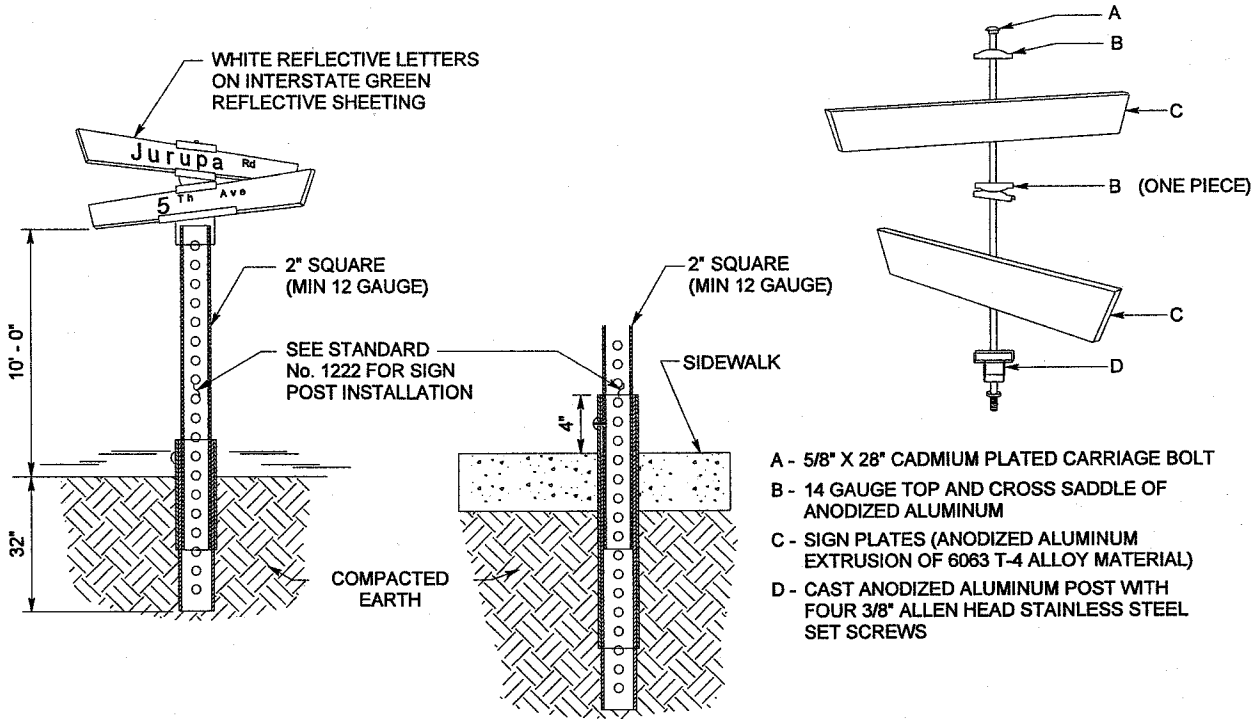
A – County Standards No. 1221 and No. 1222



DIRT LOCATION

SIDEWALK LOCATION

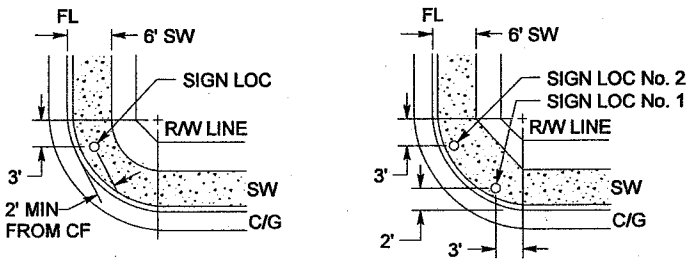
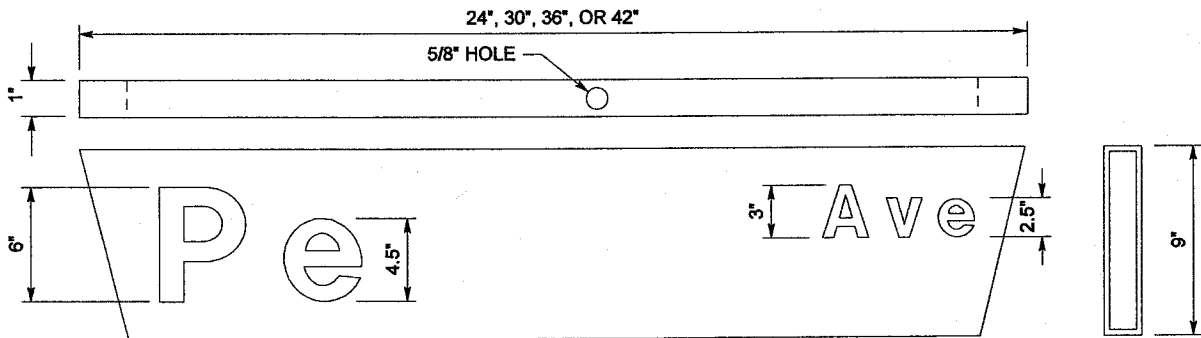

SIGN LOC No. 1 - FOR RESIDENTIAL STREETS WITHIN A TRACT
 SIGN LOC No. 2 - ALL OTHER STREETS

NOTE:
 ONE COMPLETE NAME SIGN UNIT IS REQUIRED AT EACH INTERSECTION WHEN PAVED WIDTHS OR CURBED WIDTHS OF ALL INTERSECTING STREETS ARE 60 FEET OR LESS. AT INTERSECTIONS WITH AN ULTIMATE PAVED WIDTH OR CURBED WIDTH GREATER THAN 60 FEET, USE STANDARD 1220.

**INSIDE OF KNUCKLE INTERSECTION
 SIGN INSTALLATION DETAILS**

APPROVED BY:										COUNTY OF RIVERSIDE				
DIRECTOR OF TRANSPORTATION JUAN C. PEREZ, RCE 49568										DATE				
REVISIONS		REV	BY:	APR'D	DATE	REV	BY:	APR'D	DATE	NO SCALE				
		1	JK	JP	08-05-10	4				STANDARD No. 1221				
		2				5								
		3				6								

RIVET LOCATIONS
SEE NOTE 6 ON
SHEET 2 OF 2

DIRECTION OF
TRAFFIC FLOW

STREET SIDE
OF POST

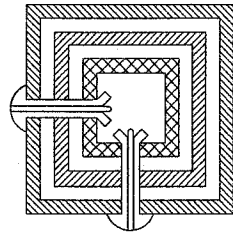

SECTION "A-A"

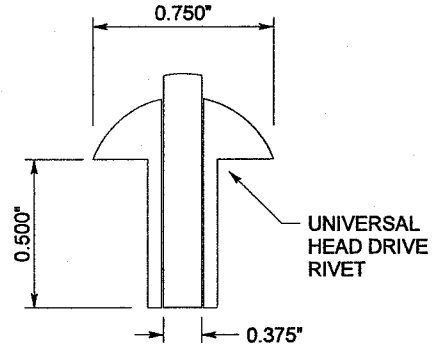

RIVET DETAIL

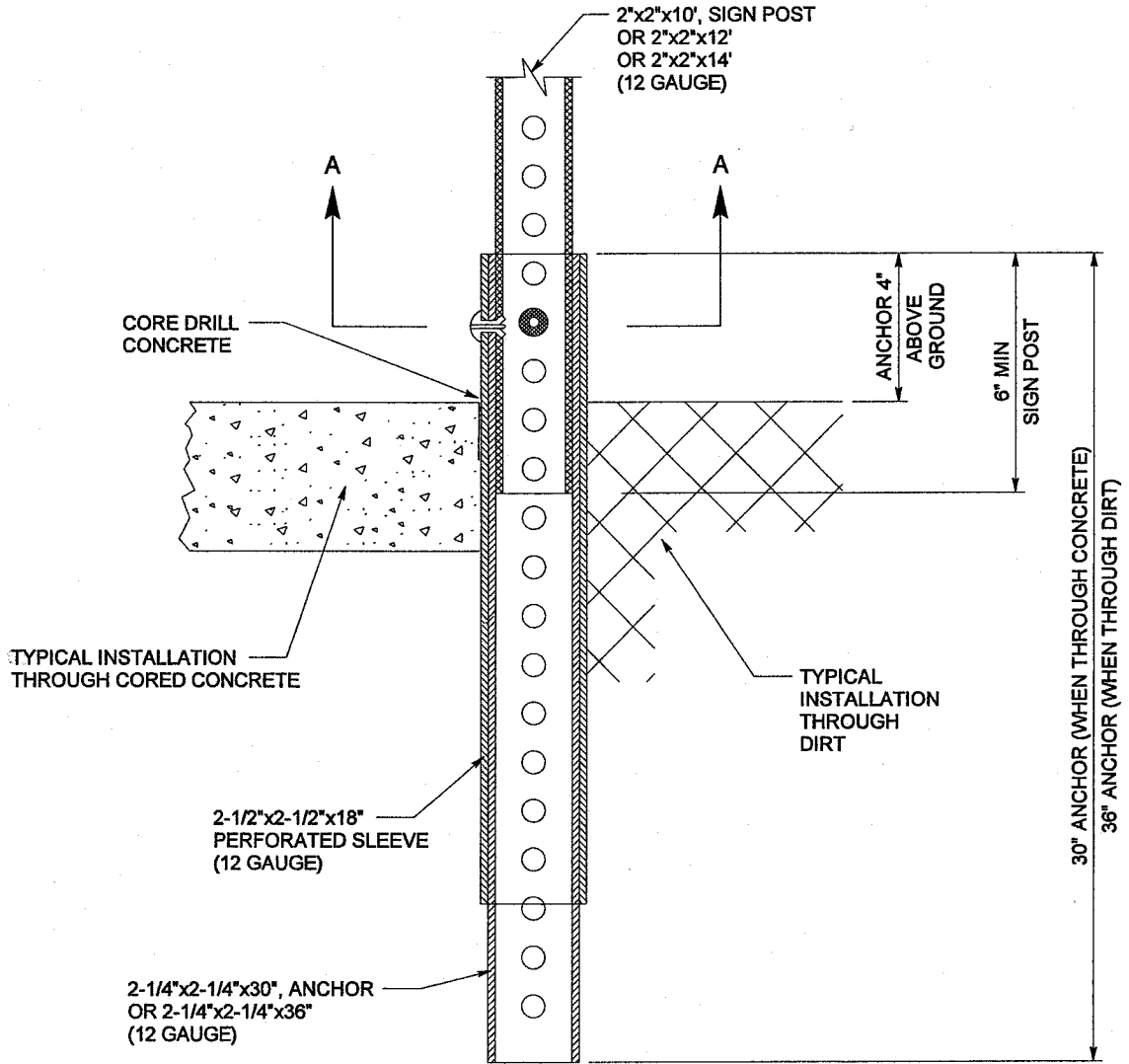

ATTACHMENT 'A' TO ADDENDUM No. 2, PAGE 2 OF 3

APPROVED BY:

DIRECTOR OF TRANSPORTATION
JUAN C. PEREZ, RCE 49568

DATE



COUNTY OF RIVERSIDE

**SIGN POST
INSTALLATION**

NO SCALE

STANDARD No. 1222 (1 of 2)

REVISIONS	REV	BY	APR'D	DATE	REV	BY	APR'D	DATE
	1	JK	JP	08-05-10	4			
	2				5			
	3				6			

**Riverside County Transportation Department
Summary of Bids**

**PROJECT: Brown Street
Low Water Crossing and Street Improvement Project
From Souder Street to Cajalco Road, Mead Valley Area**

Advertised: June 5, 2012 (Agenda Item: 3.63)
Addenda: 1 (June 5, 2012), 2 (June 26, 2012)
Bids Open: 2 pm Date: Tuesday, July 3, 2012

PROJECT No. C2-0013

Base Bid ITEM NO.	ITEM CODE	CONTRACT ITEM	UNITS	QUANTITY	COUNTY'S ESTIMATE			Panorama General Engineering, Inc. Rancho Cucamonga, CA 91730
					UNIT PRICE	ENG ESTIMATE	BID UNIT PRICE	
1	066102	DUST ABATEMENT	LS	1	1,000.00	1,000.00	1,750.00	1,750.00
2	074020	WATER POLLUTION CONTROL	LS	1	3,000.00	3,000.00	3,500.00	3,500.00
3	120100	TRAFFIC CONTROL SYSTEM	LS	1	8,000.00	8,000.00	6,700.00	6,700.00
4	153210	REMOVE CONCRETE	LS	1	2,500.00	2,500.00	1,900.00	1,900.00
5	160101	CLEARING AND GRUBBING	LS	1	6,000.00	6,000.00	600.00	600.00
6	170101	DEVELOP WATER SUPPLY	LS	1	1,000.00	1,000.00	1,625.00	1,625.00
7	190101	ROADWAY EXCAVATION [INCLUDING GRINDING AC PAVEMENT]	CY	280	35.00	9,800.00	20.50	5,740.00
8	198001	IMPORTED BORROW	CY	820	40.00	32,800.00	13.25	10,865.00
9	260201	CLASS 2 AGGREGATE BASE	CY	262	45.00	11,790.00	46.50	12,183.00
10	390132	HOT MIX ASPHALT (TYPE A)	TON	320	95.00	30,400.00	93.50	29,920.00
11	193006	STRUCTURE BACKFILL (SLURRY CEMENT)	CY	36	120.00	4,320.00	139.50	5,022.00
12	401000	PORTLAND CEMENT CONCRETE PAVEMENT	CY	17	400.00	6,800.00	305.00	5,185.00
13	510501	MINOR CONCRETE (HEADWALL & WINGWALL)	CY	10	1,200.00	12,000.00	3,030.00	30,300.00
14	510502	MINOR CONCRETE (MINOR STRUCTURE - PCC DIP SECTION)	CY	62	600.00	37,200.00	330.00	20,460.00
15	862065	REPLACE PULL BOX [TRAFFIC BEARING]	EA	2	700.00	1,400.00	2,525.00	5,050.00
16	393001	PAVEMENT REINFORCING FABRIC (GEOTEXTILE FABRIC)	SQYD	1,860	1.50	2,790.00	3.00	5,580.00
17	566011	ROADSIDE SIGN - ONE POST	EA	6	300.00	1,800.00	225.00	1,350.00
18	568017	ROADSIDE SIGN [INSTALL ON EXISTING POST]	EA	2	120.00	240.00	132.00	264.00
19	667013	28" X 20" CORRUGATED STEEL PIPE ARCH (0.079" THICK)	LF	113	350.00	39,550.00	68.00	7,684.00
20	721011	ROCK SLOPE PROTECTION (NO.2, METHOD B)	CY	17	90.00	1,530.00	180.00	3,060.00
21	729010	ROCK SLOPE PROTECTION FABRIC	SQFT	520	3.00	1,560.00	2.65	1,378.00
22	860811	DETECTOR LOOP [REPLACE EXISTING]	EA	4	500.00	2,000.00	600.00	2,400.00
23	820107	DELINEATORS (CLASS 1) [SURFACE MOUNTED POST TUBE]	EA	28	50.00	1,400.00	37.50	1,050.00
24	840515	THERMOPLASTIC PAVEMENT MARKING	SQFT	150	8.00	1,200.00	8.00	1,200.00
25	840501	THERMOPLASTIC TRAFFIC STRIPE	LF	2,000	3.00	6,000.00	0.85	1,700.00
26	019901	DE-MOBILIZATION	LS	1	11,000.00	11,000.00	11,000.00	11,000.00
PROJECT TOTAL						237,080.00		177,466.00
ITEMS 1 - 26								

**Riverside County Transportation Department
Summary of Bids**

**PROJECT: Brown Street
Low Water Crossing and Street Improvement Project
From Souder Street to Cajalco Road, Mead Valley Area
PROJECT No. C2-0013**

Advised: June 5, 2012 (Agenda Item: 3.63)
Addenda: 1 (June 5, 2012), 2 (June 26, 2012)
Bids Open: 2 pm Date: Tuesday, July 3, 2012

Base Bid ITEM NO.	ITEM CODE	CONTRACT ITEM	UNITS	QUANTITY	2		3	
					Hilcrest Contracting Corona, CA 92878 BID UNIT PRICE	BID ESTIMATE	Cooley Construction, Inc. Hesperia, CA 92340 BID UNIT PRICE	BID ESTIMATE
1	066102	DUST ABATEMENT	LS	1	2,500.00	2,500.00	3,500.00	3,500.00
2	074020	WATER POLLUTION CONTROL	LS	1	3,000.00	3,000.00	6,800.00	6,800.00
3	120100	TRAFFIC CONTROL SYSTEM	LS	1	6,000.00	6,000.00	12,800.00	12,800.00
4	153210	REMOVE CONCRETE	LS	1	3,140.00	3,140.00	6,800.00	6,800.00
5	160101	CLEARING AND GRUBBING	LS	1	6,000.00	6,000.00	6,000.00	6,000.00
6	170101	DEVELOP WATER SUPPLY	LS	1	1,130.00	1,130.00	1,000.00	1,000.00
7	190101	ROADWAY EXCAVATION [INCLUDING GRINDING AC PAVEMENT]	CY	280	35.00	9,800.00	59.00	16,520.00
8	198001	IMPORTED BORROW	CY	820	15.48	12,693.60	13.30	10,906.00
9	260201	CLASS 2 AGGREGATE BASE	CY	262	39.00	10,218.00	35.00	9,170.00
10	390132	HOT MIX ASPHALT (TYPE A)	TON	320	81.25	26,000.00	80.00	25,600.00
11	193006	STRUCTURE BACKFILL (SLURRY CEMENT)	CY	36	117.00	4,212.00	186.00	6,696.00
12	401000	PORTLAND CEMENT CONCRETE PAVEMENT	CY	17	520.00	8,840.00	614.00	10,438.00
13	510501	MINOR CONCRETE (HEADWALL & WINGWALL)	CY	10	2,100.00	21,000.00	1,090.00	10,900.00
14	510502	MINOR CONCRETE (MINOR STRUCTURE - PCC DIP SECTION)	CY	62	330.00	20,460.00	448.00	27,776.00
15	862065	REPLACE PULL BOX [TRAFFIC BEARING]	EA	2	3,150.00	6,300.00	1,730.00	3,460.00
16	393001	PAVEMENT REINFORCING FABRIC (GEOTEXTILE FABRIC)	SQYD	1,860	1.22	2,269.20	2.30	4,278.00
17	566011	ROADSIDE SIGN - ONE POST	EA	6	205.00	1,230.00	210.00	1,260.00
18	568017	ROADSIDE SIGN [INSTALL ON EXISTING POST]	EA	2	120.00	240.00	124.00	248.00
19	667013	28" X 20" CORRUGATED STEEL PIPE ARCH (0.079" THICK)	LF	113	117.00	13,221.00	93.00	10,509.00
20	721011	ROCK SLOPE PROTECTION (NO.2, METHOD B)	CY	17	296.00	5,032.00	220.00	3,740.00
21	729010	ROCK SLOPE PROTECTION FABRIC	SQFT	520	1.62	842.40	2.10	1,092.00
22	860811	DETECTOR LOOP [REPLACE EXISTING]	EA	4	790.00	3,160.00	650.00	2,600.00
23	820107	DELINEATORS (CLASS 1) [SURFACE MOUNTED POST TUBE]	EA	28	34.00	952.00	35.00	980.00
24	840515	THERMOPLASTIC PAVEMENT MARKING	SQFT	150	7.30	1,095.00	7.60	1,140.00
25	840501	THERMOPLASTIC TRAFFIC STRIPE	LF	2,000	0.79	1,580.00	0.81	1,620.00
26	019901	DE-MOBILIZATION	LS	1	11,000.00	11,000.00	11,000.00	11,000.00
PROJECT TOTAL						181,915.20		196,833.00
ITEMS 1 - 26								

**Riverside County Transportation Department
Summary of Bids**

**PROJECT: Brown Street
Low Water Crossing and Street Improvement Project
From Souder Street to Cajalco Road, Mead Valley Area
PROJECT No. C2-0013**

Advertised: June 5, 2012 (Agenda Item: 3.63)
Addenda: 1 (June 5, 2012), 2 (June 26, 2012)
Bids Open: 2 pm Date: Tuesday, July 3, 2012

Base Bid ITEM NO.	ITEM CODE	CONTRACT ITEM	UNITS	QUANTITY	4		5	
					BID UNIT PRICE	BID ESTIMATE	BID UNIT PRICE	BID ESTIMATE
1	066102	DUST ABATEMENT	LS	1	8,200.00	8,200.00	3,825.00	3,825.00
2	074020	WATER POLLUTION CONTROL	LS	1	3,500.00	3,500.00	10,000.00	10,000.00
3	120100	TRAFFIC CONTROL SYSTEM	LS	1	7,180.00	7,180.00	6,000.00	6,000.00
4	153210	REMOVE CONCRETE	LS	1	3,450.00	3,450.00	3,500.00	3,500.00
5	160101	CLEARING AND GRUBBING	LS	1	5,300.00	5,300.00	2,750.00	2,750.00
6	170101	DEVELOP WATER SUPPLY	LS	1	2,500.00	2,500.00	8,000.00	8,000.00
7	190101	ROADWAY EXCAVATION [INCLUDING GRINDING AC PAVEMENT]	CY	280	32.50	9,100.00	60.00	16,800.00
8	198001	IMPORTED BORROW	CY	820	43.60	35,752.00	25.00	20,500.00
9	260201	CLASS 2 AGGREGATE BASE	CY	262	23.00	6,026.00	50.00	13,100.00
10	390132	HOT MIX ASPHALT (TYPE A)	TON	320	105.20	33,664.00	105.00	33,600.00
11	193006	STRUCTURE BACKFILL (SLURRY CEMENT)	CY	36	175.00	6,300.00	100.00	3,600.00
12	401000	PORTLAND CEMENT CONCRETE PAVEMENT	CY	17	610.00	10,370.00	300.00	5,100.00
13	510501	MINOR CONCRETE (HEADWALL & WINGWALL)	CY	10	680.00	6,800.00	1,700.00	17,000.00
14	510502	MINOR CONCRETE (MINOR STRUCTURE - PCC DIP SECTION)	CY	62	460.00	28,520.00	395.00	24,490.00
15	862065	REPLACE PULL BOX [TRAFFIC BEARING]	EA	2	1,545.00	3,090.00	1,900.00	3,800.00
16	393001	PAVEMENT REINFORCING FABRIC (GEOTEXTILE FABRIC)	SQYD	1,860	3.25	6,045.00	2.75	5,115.00
17	566011	ROADSIDE SIGN - ONE POST	EA	6	234.00	1,404.00	225.00	1,350.00
18	568017	ROADSIDE SIGN [INSTALL ON EXISTING POST]	EA	2	138.00	276.00	150.00	300.00
19	667013	28" X 20" CORRUGATED STEEL PIPE ARCH (0.079" THICK)	LF	113	65.00	7,345.00	195.00	22,035.00
20	721011	ROCK SLOPE PROTECTION (NO.2, METHOD B)	CY	17	350.00	5,950.00	225.00	3,825.00
21	729010	ROCK SLOPE PROTECTION FABRIC	SQFT	520	5.00	2,600.00	0.50	260.00
22	860811	DETECTOR LOOP [REPLACE EXISTING]	EA	4	780.00	3,120.00	700.00	2,800.00
23	820107	DELINEATORS (CLASS 1) [SURFACE MOUNTED POST TUBE]	EA	28	39.00	1,092.00	30.00	840.00
24	840515	THERMOPLASTIC PAVEMENT MARKING	SQFT	150	8.40	1,260.00	7.70	1,155.00
25	840501	THERMOPLASTIC TRAFFIC STRIPE	LF	2,000	0.90	1,800.00	0.75	1,500.00
26	019901	DE-MOBILIZATION	LS	1	11,000.00	11,000.00	11,000.00	11,000.00
PROJECT TOTAL						211,644.00		222,245.00
ITEMS 1 - 26								

**Riverside County Transportation Department
Summary of Bids**

Advertised: June 5, 2012 (Agenda Item: 3.63)
Addenda: 1 (June 5, 2012), 2 (June 26, 2012)
Bids Open: 2 pm Date: Tuesday, July 3, 2012

**PROJECT: Brown Street
Low Water Crossing and Street Improvement Project
From Souder Street to Cajalco Road, Mead Valley Area**

PROJECT No. C2-0013

Base Bid ITEM NO.	ITEM CODE	CONTRACT ITEM	UNITS	QUANTITY	6		7	
					BID UNIT PRICE	BID ESTIMATE	BID UNIT PRICE	BID ESTIMATE
1	066102	DUST ABATEMENT	LS	1	2,000.00	2,000.00	3,000.00	3,000.00
2	074020	WATER POLLUTION CONTROL	LS	1	5,000.00	5,000.00	5,000.00	5,000.00
3	120100	TRAFFIC CONTROL SYSTEM	LS	1	35,665.00	35,665.00	30,000.00	30,000.00
4	153210	REMOVE CONCRETE	LS	1	2,500.00	2,500.00	10,000.00	10,000.00
5	160101	CLEARING AND GRUBBING	LS	1	6,000.00	6,000.00	8,000.00	8,000.00
6	170101	DEVELOP WATER SUPPLY	LS	1	1,000.00	1,000.00	500.00	500.00
7	190101	ROADWAY EXCAVATION [INCLUDING GRINDING AC PAVEMENT]	CY	280	55.00	15,400.00	60.00	16,800.00
8	198001	IMPORTED BORROW	CY	820	16.00	13,120.00	35.00	28,700.00
9	260201	CLASS 2 AGGREGATE BASE	CY	262	40.00	10,480.00	43.00	11,266.00
10	390132	HOT MIX ASPHALT (TYPE A)	TON	320	105.00	33,600.00	125.00	40,000.00
11	193006	STRUCTURE BACKFILL (SLURRY CEMENT)	CY	36	95.00	3,420.00	125.00	4,500.00
12	401000	PORTLAND CEMENT CONCRETE PAVEMENT	CY	17	565.00	9,605.00	450.00	7,650.00
13	510501	MINOR CONCRETE (HEADWALL & WINGWALL)	CY	10	1,800.00	18,000.00	1,250.00	12,500.00
14	510502	MINOR CONCRETE (MINOR STRUCTURE - PCC DIP SECTION)	CY	62	565.00	35,030.00	450.00	27,900.00
15	862065	REPLACE PULL BOX [TRAFFIC BEARING]	EA	2	3,150.00	6,300.00	1,350.00	2,700.00
16	393001	PAVEMENT REINFORCING FABRIC (GEOTEXTILE FABRIC)	SQYD	1,860	2.50	4,650.00	2.00	3,720.00
17	566011	ROADSIDE SIGN - ONE POST	EA	6	225.00	1,350.00	250.00	1,500.00
18	568017	ROADSIDE SIGN [INSTALL ON EXISTING POST]	EA	2	225.00	450.00	200.00	400.00
19	667013	28" X 20" CORRUGATED STEEL PIPE ARCH (0.079" THICK)	LF	113	105.00	11,865.00	50.00	5,650.00
20	721011	ROCK SLOPE PROTECTION (NO.2, METHOD B)	CY	17	335.00	5,695.00	120.00	2,040.00
21	729010	ROCK SLOPE PROTECTION FABRIC	SQFT	520	1.25	650.00	2.00	1,040.00
22	860811	DETECTOR LOOP [REPLACE EXISTING]	EA	4	800.00	3,200.00	600.00	2,400.00
23	820107	DELINEATORS (CLASS 1) [SURFACE MOUNTED POST TUBE]	EA	28	40.00	1,120.00	45.00	1,260.00
24	840515	THERMOPLASTIC PAVEMENT MARKING	SQFT	150	8.00	1,200.00	15.00	2,250.00
25	840501	THERMOPLASTIC TRAFFIC STRIPE	LF	2,000	0.85	1,700.00	1.00	2,000.00
26	019901	DE-MOBILIZATION	LS	1	11,000.00	11,000.00	11,000.00	11,000.00
PROJECT TOTAL						240,000.00		241,776.00
ITEMS 1 - 26								

**Riverside County Transportation Department
Summary of Bids**

**PROJECT: Brown Street
Low Water Crossing and Street Improvement Project
From Souder Street to Cajalco Road, Mead Valley Area**

Advertised: June 5, 2012 (Agenda Item: 3.63)
Addenda: 1 (June 5, 2012), 2 (June 26, 2012)
Bids Open: 2 pm Date: Tuesday, July 3, 2012

PROJECT No. C2-0013

Base Bid ITEM NO.	ITEM CODE	CONTRACT ITEM	UNITS	8		9	
				BID UNIT PRICE	BID ESTIMATE	BID UNIT PRICE	BID ESTIMATE
1	066102	DUST ABATEMENT	LS	4,500.00	4,500.00	3,000.00	3,000.00
2	074020	WATER POLLUTION CONTROL	LS	8,500.00	8,500.00	2,500.00	2,500.00
3	120100	TRAFFIC CONTROL SYSTEM	LS	12,000.00	12,000.00	30,000.00	30,000.00
4	153210	REMOVE CONCRETE	LS	2,500.00	2,500.00	2,500.00	2,500.00
5	160101	CLEARING AND GRUBBING	LS	6,000.00	6,000.00	6,000.00	6,000.00
6	170101	DEVELOP WATER SUPPLY	LS	1,000.00	1,000.00	1,000.00	1,000.00
7	190101	ROADWAY EXCAVATION [INCLUDING GRINDING AC PAVEMENT]	CY	58.00	16,240.00	160.00	44,800.00
8	198001	IMPORTED BORROW	CY	39.00	31,980.00	15.00	12,300.00
9	260201	CLASS 2 AGGREGATE BASE	CY	54.00	14,148.00	40.00	10,480.00
10	390132	HOT MIX ASPHALT (TYPE A)	TON	80.00	25,600.00	115.00	36,800.00
11	193006	STRUCTURE BACKFILL (SLURRY CEMENT)	CY	143.00	5,148.00	220.00	7,920.00
12	401000	PORTLAND CEMENT CONCRETE PAVEMENT	CY	500.00	8,500.00	500.00	8,500.00
13	510501	MINOR CONCRETE (HEADWALL & WINGWALL)	CY	2,325.00	23,250.00	1,500.00	15,000.00
14	510502	MINOR CONCRETE (MINOR STRUCTURE - PCC DIP SECTION)	CY	655.00	40,610.00	500.00	31,000.00
15	862065	REPLACE PULL BOX [TRAFFIC BEARING]	EA	2,300.00	4,600.00	1,400.00	2,800.00
16	393001	PAVEMENT REINFORCING FABRIC (GEOTEXTILE FABRIC)	SQYD	3.00	5,580.00	2.50	4,650.00
17	566011	ROADSIDE SIGN - ONE POST	EA	204.00	1,224.00	175.00	1,050.00
18	568017	ROADSIDE SIGN [INSTALL ON EXISTING POST]	EA	120.00	240.00	100.00	200.00
19	667013	28" X 20" CORRUGATED STEEL PIPE ARCH (0.079" THICK)	LF	135.00	15,255.00	150.00	16,950.00
20	721011	ROCK SLOPE PROTECTION (NO.2, METHOD B)	CY	359.00	6,103.00	225.00	3,825.00
21	729010	ROCK SLOPE PROTECTION FABRIC	SQFT	3.40	1,768.00	3.00	1,560.00
22	860811	DETECTOR LOOP [REPLACE EXISTING]	EA	540.00	2,160.00	700.00	2,800.00
23	820107	DELINEATORS (CLASS 1) [SURFACE MOUNTED POST TUBE]	EA	35.00	980.00	40.00	1,120.00
24	840515	THERMOPLASTIC PAVEMENT MARKING	SQFT	7.50	1,125.00	9.00	1,350.00
25	840501	THERMOPLASTIC TRAFFIC STRIPE	LF	0.80	1,600.00	1.00	2,000.00
26	019901	DE-MOBILIZATION	LS	11,000.00	11,000.00	11,000.00	11,000.00
PROJECT TOTAL					251,611.00		261,105.00
ITEMS 1 - 26							

Award
package

CONTRACTOR'S PROPOSAL

TO: COUNTY OF RIVERSIDE

DATE: 06/27/12

hereafter called "County":

BIDDER: PANDORA GENERAL ENGINEERING, INC.
(hereafter called "Contractor")

THE UNDERSIGNED, Contractor, having carefully examined the site and the Contract Documents for the construction of **BROWN STREET LOW WATER CROSSING AND STREET IMPROVEMENT PROJECT, FROM SOUDER STREET TO CAJALCO ROAD, MEAD VALLEY AREA, PROJECT No. C2-0013** hereby proposes to construct the work in accordance with the Contract Documents, including Addenda Nos. 1, 2 for the amount stated in this Proposal.

By submitting this Proposal, Contractor agrees with County:

1. That unless withdrawn in person by Contractor or some person authorized in writing by Contractor not by telephone or telegram before the time specified in the Notice Inviting Bids for the public opening of bids, this Proposal constitutes an irrevocable offer for 90 calendar days after that date.
2. County has the right to reject any or all Proposals and to waive any irregularities or informalities contained in a Proposal.
3. To execute the Agreement and deliver the Faithful Performance Bond, Payment Bond and Insurance Certificate with endorsements, which comply with the requirements set forth in the Instructions to Bidders and General Conditions, within ten (10) working days of the date of the Notice of Acceptance of Proposal and Intent to Award as issued by the County of Riverside.
4. That the contract shall be awarded upon a resolution or minute order to that effect duly adopted by the governing body of County; and that execution of the Contract Documents shall constitute a written memorial thereof.
5. To submit to County such information as County may require to determine whether a particular Proposal is the lowest responsible bid submitted.

6. That the accompanying certified or cashier's check or Bid Bond is in an amount not less than 10% of the total bid submitted and constitutes a guarantee that if awarded the contract, Contractor will execute the Agreement and deliver the required bonds within ten (10) days after notice of award. If Contractor fails to execute and deliver said documents, the check or bond is to be charged with the costs of the resultant damages to County, including but not limited to publication costs, the difference in money between the amount bid and the amount in excess of the bid which it costs County to do or cause to be done the work involved, lease and rental costs, additional salaries and overhead, increased interest and costs of funding the project, attorney expense, additional engineering and architectural expense and cost of maintaining or constructing alternate facilities occasioned by the failure to execute and deliver said documents.
7. By signing this proposal the Contractor certifies that the representations made therein are made under penalty of perjury.

**BROWN STREET
LOW WATER CROSSING AND STREET IMPROVEMENT PROJECT
FROM SOUDER STREET TO CAJALCO ROAD
MEAD VALLEY AREA**

PROJECT NO. C2-0013

PROPOSAL (Revised by Addendum No. 1)

ITEM No.	ITEM CODE	ITEM	UNIT	ESTIMATED QUANTITY	ITEM PRICE (IN FIGURES)	TOTAL (IN FIGURES)
1	066102	DUST ABATEMENT	LS	1	1,750-	1,750
2	074020	WATER POLLUTION CONTROL	LS	1	3,500-	3,500-
3	120100	TRAFFIC CONTROL SYSTEM	LS	1	6,700-	6,700-
4	153210	REMOVE CONCRETE	LS	1	1,400-	1,400-
5	160101	CLEARING AND GRUBBING	LS	1	600-	600-
6	170101	DEVELOP WATER SUPPLY	LS	1	1,1625-	1,1625-
7	190101	ROADWAY EXCAVATION [INCLUDING GRINDING AC PAVEMENT]	CY	280	20.50	5,740-
8	198001	IMPORTED BORROW	CY	820	13.25	10,865-
9	260201	CLASS 2 AGGREGATE BASE	CY	262	46.50	12,183-
10	390132	HOT MIX ASPHALT (TYPE A)	TON	320	93.50	29,920
11	193006	STRUCTURE BACKFILL (SLURRY CEMENT)	CY	36	139.50	5,022-
12	401000	PORTLAND CEMENT CONCRETE PAVEMENT	CY	17	305.	5,185-
13	510501	MINOR CONCRETE (HEADWALL & WINGWALL)	CY	10	3,030-	30,300-
14	510502	MINOR CONCRETE (MINOR STRUCTURE - PCC DIP SECTION)	CY	62	330-	20,460-
15	862065	REPLACE PULL BOX [TRAFFIC BEARING]	EA	2	2,525-	5,050-
16	393001	PAVEMENT REINFORCING FABRIC (GEOTEXTILE FABRIC)	SQYD	1,860	3-	5,580-
17	566011	ROADSIDE SIGN - ONE POST	EA	6	225-	1,350-
18	568017	ROADSIDE SIGN [INSTALL ON EXISTING POST]	EA	2	132-	264-
19	667013	28" X 20" CORRUGATED STEEL PIPE ARCH (0.079" THICK)	LF	113	68-	7,684-
20	721011	ROCK SLOPE PROTECTION (NO.2, METHOD B)	CY	17	180-	3,060-
21	729010	ROCK SLOPE PROTECTION FABRIC	SQFT	520	2.65	1,378-
22	860811	DETECTOR LOOP [REPLACE EXISTING]	EA	4	600-	2,400-
23	820107	DELINEATORS (CLASS 1) [SURFACE MOUNTED POST TUBE]	EA	28	37.50	1,050-
24	840515	THERMOPLASTIC PAVEMENT MARKING	SQFT	150	8-	1,200-
25	840501	THERMOPLASTIC TRAFFIC STRIPE	LF	2,000	0.85	1,700-
26	019901	DE-MOBILIZATION	LS	1	11,000.00	11,000.00

PROJECT TOTAL:
ITEMS 1-26

~~ONE HUNDRED SEVENTY SEVEN THOUSAND FOUR HUNDRED SIXTY SIX DOLLARS~~ ^{no/100} \$ 177,466.00

"WORDS"

BIDDER DATA:

Name of Bidder PANORAMA GENERAL ENGINEERING, INC.

Type of Organization CORPORATION

Person(s) Authorized to Sign for Bidder ROBERT W. DYE, JR. - PRESIDENT, TREASURER, CEO

DAVID L. WHITE - VICE PRESIDENT, SECRETARY, CFO

Address 9007 ARROW ROUTE, SUITE 140

RANCHO CUCAMONIA, CA 91730 Phone (909) 941-4272

Contractor's License 937187 A
Type & Number

Expiration Date 08/31/13

8. **DESIGNATION OF SUBCONTRACTORS:** Contractor submits the following complete list of each subcontractor who will perform work or labor or render service in or about the construction in an amount in excess of 1/2 of 1% of the total bid.

<u>ITEM</u>	<u>SUBCONTRACTOR</u>	<u>ADDRESS</u>	<u>LICENSE NO.</u>
17,18,23,24,25	BC TRAFFIC SPECIALISTS	638 W. SOUTHWEST AVE., ORANGE, CA 92665	877686
15,22	MSL ELECTRIC	4938 E. LA PALMA, ANAHEIM, CA 92807	822450
12,13,14	MARTINEZ CONCRETE, INC.	920 W. FOOTHILL BLVD, AZUSA, CA 91702	394471

Percent of work to be performed by sub-contractors: 33 %
(Note: 50% of the work required to be performed by general contractor)

IN WITNESS WHEREOF Contractor executed this Proposal as of the date set forth on Page 1 of this proposal.

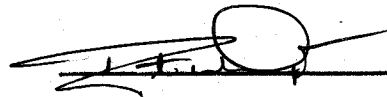

ROBERT W. DYE, JR.

TITLE PRESIDENT
"Contractor"

Non-Collusion Declaration

To be executed by bidder and submitted with bid. (Public Contract Code Section 7106)

The undersigned declares:

I am the PRESIDENT (Title) of PANORAMA GENERAL ENGINEERING, INC. (Company),
the party making the foregoing bid.

The bid is not made in the interest of, or on behalf of, any undisclosed person, partnership, company, association, organization, or corporation. The bid is genuine and not collusive or sham. The bidder has not directly or indirectly induced or solicited any other bidder to put in a false or sham bid. The bidder has not directly or indirectly colluded, conspired, connived, or agreed with any bidder or anyone else to put in a sham bid, or that anyone shall refrain from bidding. The bidder has not in any manner, directly or indirectly, sought by agreement, communication, or conference with anyone to fix the bid price of the bidder or any other bidder, or to fix any overhead, profit, or cost element of the bid price, or of that of any other bidder.

All statements contained in the bid are true. The bidder has not, directly or indirectly, submitted his or her bid price of any breakdown thereof, or the contents thereof, or divulged information or data relative thereto, to any corporation, partnership, company, association, organization, bid depository, or to any member or agent thereof to effectuate a collusive or sham bid, and has not paid, and will not pay, any person or entity for such purpose.

Any person executing this declaration on behalf of a bidder that is a corporation, partnership, joint venture, limited liability company, limited liability partnership, or any other entity, hereby represents that he or she has full power to execute, and does execute, this declaration on behalf of the bidder.

I declare under penalty of perjury under the laws of the State of California that the foregoing is true and correct and that this declaration is executed on

JUNE (Month) 27 (Day) of 2012 (Year),

at RANCHO CUCAMONGA (City), California.

Signature of Declarant:  _____

Printed name of Declarant: ROBERT W. DYE, JR.

Name of Bidder (Company): PANORAMA GENERAL ENGINEERING, INC.

Title or Office: PRESIDENT

Note: Notarization of signature required.

Check box if attachment is included.

CALIFORNIA ALL-PURPOSE ACKNOWLEDGMENT

CIVIL CODE § 1189

State of California

County of San Bernardino }

On June 27 2012 before me, Cathryn A Yeager, Notary _____
Date Here Insert Name and Title of the Office

personally appeared Robert W. Dyer, Jr. _____
Name(s) of Signer(s)

who proved to me on the basis of satisfactory evidence to be the person(s) whose name(s) is/are subscribed to the within instrument and acknowledged to me that he/~~she/they~~ executed the same in his/~~her/their~~ authorized capacity(ies), and that by his/~~her/their~~ signature(s) on the instrument the person(s), or the entity upon behalf of which the person(s) acted, executed the instrument.

I certify under PENALTY OF PERJURY under the laws of the State of California that the foregoing paragraph is true and correct.

WITNESS my hand and official seal.



Place Notary Seal Above

Signature Cathryn A Yeager _____
Signature of Notary Public

OPTIONAL

Though the information below is not required by law, it may prove valuable to persons relying on the document and could prevent fraudulent removal and reattachment of this form to another document.

Description of Attached Document

Title or Type of Document: _____

Document Date: _____ Number of Pages: _____

Signer(s) Other Than Named Above: _____

Capacity(ies) Claimed by Signer(s)

Signer's Name: _____ Signer's Name: _____

Corporate Officer — Title(s): _____ Corporate Officer — Title(s): _____

Individual Individual

Partner — Limited General Partner — Limited General

Attorney in Fact Attorney in Fact

Trustee Trustee

Guardian or Conservator Guardian or Conservator

Other: _____ Other: _____

Signer Is Representing: _____ Signer Is Representing: _____

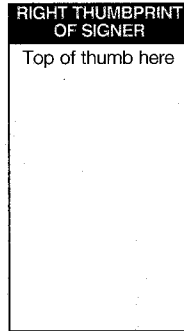
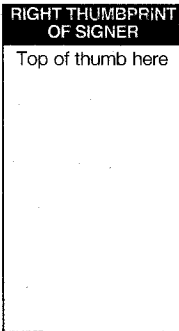

This addendum has been prepared under the direction of the following registered Civil Engineer(s):

Civil Engineering Only

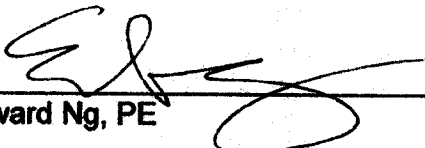

Edward Ng, PE

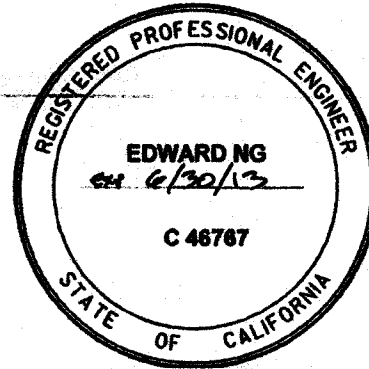

Recommended by:



Scott Staley, PE
County Project Manager

Concurrence:



Khalid Nasim, PE
Engineering Division Manager

Acknowledged:

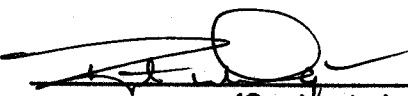

(Contractor)

Date: 06/27/12

JRJ:jjr:rr

This addendum has been prepared under the direction of the following registered Civil Engineer(s):

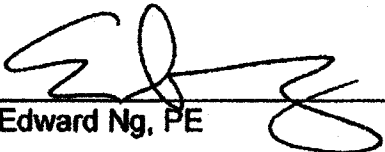
Edward Ng, PE

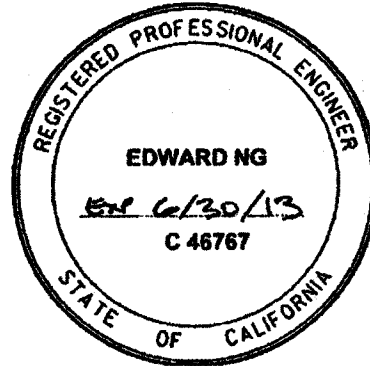

Recommended by:

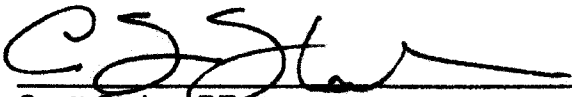
Scott Staley, PE
County Project Manager

Concurrence:

Khalid Nasim, PE
Engineering Division Manager

Acknowledged: 
(Contractor)

Date: 7-3-12

JRJ:jjr:rr

BID BOND

Recitals:

1. Panorama General Engineering, Inc "Contractor", has submitted his Contractor's Proposal to County of Riverside, "County", for the construction of public work for Brown Street Low Water Crossing And Street Improvement Project, From Souder Street To Cajalco Road, Mead Valley Area, Project No. C2-0013 in accordance with a Notice Inviting Bids of County dated June 27, 2012.

2. Developers Surety and Indemnity Company a n Iowa corporation, hereafter called "Surety", is the surety of this Bond.

Agreement:

We, Contractor as principal and Surety as surety, jointly and severally agree and state as follows:

1. The amount of the obligation of this bond is 10% of the amount of the Contractor's Proposal, including bid alternates, and inures to the benefit of County.
2. This Bond is exonerated by (1) County rejecting said Proposal or, in the alternate, (2) if said Proposal is accepted, Contractor executes the Agreement and furnishes the Bonds as agreed to in its Proposal, otherwise it remains in full force and effect for the recovery of loss, damage and expense of County resulting from failure of Contractor to act as agreed to in its Proposal. Some types of possible loss, damage and expense are specified in the Contractor's Proposal.
3. Surety, for value received, stipulates and agrees that its obligations hereunder shall in no way be impaired or affected by any extension of time within which County may accept the Proposal and waives notice of any such extension.
4. This Bond is binding on our heirs, executors, administrators, successors and assigns.

Dated: June 27, 2012

Developers Surety and Indemnity Company

By [Signature]
Title: Attorney in Fact
"Surety"

Panorama General Engineering, Inc

By [Signature]
Title: President - Robert W. Dye, Jr.
"Contractor"

STATE OF CALIFORNIA
COUNTY OF _____

} ss. SURETY'S ACKNOWLEDGEMENT

On _____ before me, _____ personally appeared, _____, known to me, or proved to me on the basis of satisfactory evidence, to be the person whose name is subscribed to the within instrument and acknowledged to me that he/she executed the same in his/her authorized capacities, and that by his/her signature on the instrument the person, or the entity upon behalf of which the person acted, executed the instrument.

WITNESS my hand and official seal.

Signature of Notary Public

SEE ATTACHED

Notary Public (Seal)

Note: All signatures must be notarized

CALIFORNIA ALL-PURPOSE ACKNOWLEDGMENT

CIVIL CODE § 1189

State of California

County of San Bernardino

On June 27, 2012 before me, Cathryn A Yeager, Notary

Date

Here Insert Name and Title of the Officer

personally appeared Scott Edward Pulido

Name(s) of Signer(s)

who proved to me on the basis of satisfactory evidence to be the person(s) whose name(s) is/are subscribed to the within instrument and acknowledged to me that he/she/they executed the same in his/her/their authorized capacity(ies), and that by his/her/their signature(s) on the instrument the person(s), or the entity upon behalf of which the person(s) acted, executed the instrument.

I certify under PENALTY OF PERJURY under the laws of the State of California that the foregoing paragraph is true and correct.

WITNESS my hand and official seal.

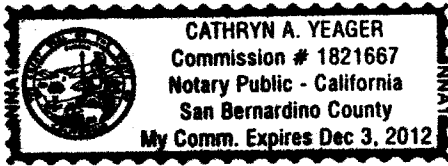

Place Notary Seal Above

Signature: Cathryn A Yeager

Signature of Notary Public

OPTIONAL

Though the information below is not required by law, it may prove valuable to persons relying on the document and could prevent fraudulent removal and reattachment of this form to another document.

Description of Attached Document

Title or Type of Document: _____

Document Date: _____ Number of Pages: _____

Signer(s) Other Than Named Above: _____

Capacity(ies) Claimed by Signer(s)

Signer's Name: _____

Signer's Name: _____

Corporate Officer — Title(s): _____

Corporate Officer — Title(s): _____

Individual

Individual

Partner — Limited General

Partner — Limited General

Attorney in Fact

Attorney in Fact

Trustee

Trustee

Guardian or Conservator

Guardian or Conservator

Other: _____

Other: _____

Signer Is Representing: _____

Signer Is Representing: _____

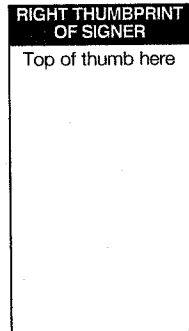
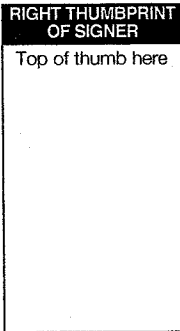

CALIFORNIA ALL-PURPOSE ACKNOWLEDGMENT

CIVIL CODE § 1189

State of California

County of San Bernardino

On June 27, 2012 before me, Cathryn A. Yeager, Notary

Date

Here Insert Name and Title of the Officer

personally appeared Robert W. Dye, Jr.

Name(s) of Signer(s)

who proved to me on the basis of satisfactory evidence to be the person(s) whose name(s) is/are subscribed to the within instrument and acknowledged to me that he/she/they executed the same in his/her/their authorized capacity(ies), and that by his/her/their signature(s) on the instrument the person(s), or the entity upon behalf of which the person(s) acted, executed the instrument.

I certify under PENALTY OF PERJURY under the laws of the State of California that the foregoing paragraph is true and correct.

WITNESS my hand and official seal.

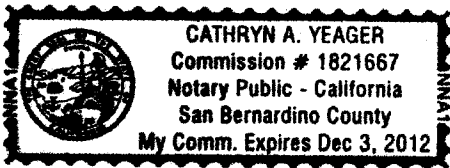

Place Notary Seal Above

Signature: Cathryn A. Yeager

Signature of Notary Public

OPTIONAL

Though the information below is not required by law, it may prove valuable to persons relying on the document and could prevent fraudulent removal and reattachment of this form to another document.

Description of Attached Document

Title or Type of Document: _____

Document Date: _____ Number of Pages: _____

Signer(s) Other Than Named Above: _____

Capacity(ies) Claimed by Signer(s)

Signer's Name: _____

Signer's Name: _____

Corporate Officer -- Title(s): _____

Corporate Officer -- Title(s): _____

Individual

Individual

Partner -- Limited General

Partner -- Limited General

Attorney in Fact

Attorney in Fact

Trustee

Trustee

Guardian or Conservator

Guardian or Conservator

Other: _____

Other: _____

Signer Is Representing: _____

Signer Is Representing: _____

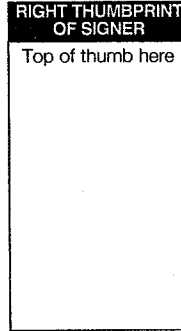
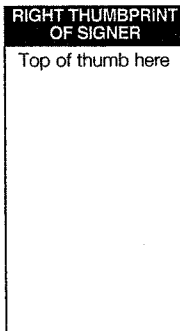

**POWER OF ATTORNEY FOR
DEVELOPERS SURETY AND INDEMNITY COMPANY
INDEMNITY COMPANY OF CALIFORNIA
PO Box 19725, IRVINE, CA 92623 (949) 263-3300**

KNOW ALL BY THESE PRESENTS that except as expressly limited, DEVELOPERS SURETY AND INDEMNITY COMPANY and INDEMNITY COMPANY OF CALIFORNIA, do each hereby make, constitute and appoint: ***Scott Edward Pulido***

as their true and lawful Attorney(s)-in-Fact, to make, execute, deliver and acknowledge, for and on behalf of said corporations, as sureties, bonds, undertakings and contracts of suretyship giving and granting unto said Attorney(s)-in-Fact full power and authority to do and to perform every act necessary, requisite or proper to be done in connection therewith as each of said corporations could do, but reserving to each of said corporations full power of substitution and revocation, and all of the acts of said Attorney(s)-in-Fact, pursuant to these presents, are hereby ratified and confirmed.

This Power of Attorney is granted and is signed by facsimile under and by authority of the following resolutions adopted by the respective Boards of Directors of DEVELOPERS SURETY AND INDEMNITY COMPANY and INDEMNITY COMPANY OF CALIFORNIA, effective as of January 1st, 2008.

RESOLVED, that a combination of any two of the Chairman of the Board, the President, Executive Vice-President, Senior Vice-President or any Vice President of the corporations be, and that each of them hereby is, authorized to execute this Power of Attorney, qualifying the attorney(s) named in the Power of Attorney to execute, on behalf of the corporations, bonds, undertakings and contracts of suretyship; and that the Secretary or any Assistant Secretary of either of the corporations be, and each of them hereby is, authorized to attest the execution of any such Power of Attorney;

RESOLVED, FURTHER, that the signatures of such officers may be affixed to any such Power of Attorney or to any certificate relating thereto by facsimile, and any such Power of Attorney or certificate bearing such facsimile signatures shall be valid and binding upon the corporations when so affixed and in the future with respect to any bond, undertaking or contract of suretyship to which it is attached.

IN WITNESS WHEREOF, DEVELOPERS SURETY AND INDEMNITY COMPANY and INDEMNITY COMPANY OF CALIFORNIA have severally caused these presents to be signed by their respective officers and attested by their respective Secretary or Assistant Secretary this October 4th, 2011.

By: *Daniel Young*
Daniel Young, Senior Vice-President

By: *Steve A. Tvedt*
Steve A. Tvedt, Vice-President

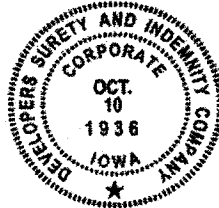

State of California
County of Orange

On October 4, 2011 before me, Antonio Alvarado, Notary Public
Date Here Insert Name and Title of the Officer

personally appeared Daniel Young and Steve A. Tvedt
Name(s) of Signer(s)

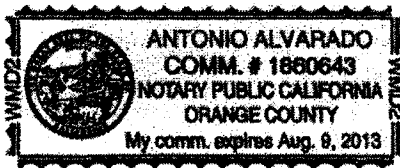

Place Notary Seal Above

who proved to me on the basis of satisfactory evidence to be the person(s) whose name(s) is/are subscribed to the within instrument and acknowledged to me that he/she/they executed the same in his/her/their authorized capacity(ies), and that by his/her/their signature(s) on the instrument the person(s), or the entity upon behalf of which the person(s) acted, executed the instrument.

I certify under PENALTY OF PERJURY under the laws of the State of California that the foregoing paragraph is true and correct.

WITNESS my hand and official seal.

Signature *Antonio Alvarado*
Antonio Alvarado, Notary Public

CERTIFICATE

The undersigned, as Secretary or Assistant Secretary of DEVELOPERS SURETY AND INDEMNITY COMPANY or INDEMNITY COMPANY OF CALIFORNIA, does hereby certify that the foregoing Power of Attorney remains in full force and has not been revoked and, furthermore, that the provisions of the resolutions of the respective Boards of Directors of said corporations set forth in the Power of Attorney are in force as of the date of this Certificate.

This Certificate is executed in the City of Irvine, California, this _____ day of _____

By: *Gregg N. Okura*
Gregg Okura, Assistant Secretary

AGREEMENT

THIS AGREEMENT is entered into at Riverside, California as of the date set forth below is between County of Riverside hereafter called "County" and **PANORAMA GENERAL ENGINEERING, INC.** hereafter called "Contractor".

WITNESSETH

RECITALS:

1. Contractor has submitted to County his Contractor's Proposal for the construction of County Project, **Brown Street Low Water Crossing And Street Improvement Project, From Souder Street To Cajalco Road, Mead Valley Area, Project No. C2-0013**, in strict accordance with the Contract Documents identified below and County has accepted said Proposal.
2. Contractor states that he has reexamined his Contractor's Proposal and found it to be correct, has ascertained that his subcontractors are properly licensed and possess the requisite skill and forces, has reexamined the site and Contract Documents and is of the opinion that he can presently do the work in accordance with the Contract Documents for the money set forth in his Proposal to be paid as provided in the Contract Documents.

AGREEMENT:

IT IS AGREED BY THE PARTIES AS FOLLOWS:

1. Contract Documents. The entire contract consists of the following: (a) The Agreement. (b) The Notice Inviting Bids. (c) The Instruction to Bidders. (d) The Contractor's Proposal. (e) The Bid Bond. (f) The Payment Bond. (g) The Performance Bond. (h) The General Conditions. (i) The Special Provisions. (j) The Standard Specifications of the State of California Department of Transportation edition of May 2006 as modified in other portions of the Contract Documents. (k) The Standard Plans of the Department of Transportation identified on the plans or in the Special Provisions. (l) The Plans. (m) Addenda No. **(One, Two)**. (n) The Determination of Prevailing Wage Rates for Public Work. (o) Any Change Orders issued. (p) Any additional or supplemental specifications, notice, instructions and drawings issued in accordance with the provisions of the Contract Documents. All of said Documents presently in existence are by this reference incorporated herein with like effect as if here set forth in full and upon the proper issuance of other documents they shall likewise be deemed incorporated. The Bid Bond is exonerated upon execution of this Agreement and the Payment Bond and Faithful Performance Bond.
2. The Work. Contractor shall do all things necessary to construct the work generally described in Recital No. 1 in accordance with the Contract Documents.

3. Liquidated Damages and Time of Completion. Attention is directed to the provisions in Section 8-1.06, "Time of Completion", and in Section 8-1.07, "Liquidated Damages", of the Standard Specifications and these Special Provisions.

The Contractor shall begin work within 15 days of the date stated within the written "Notice to Proceed".

The Contractor shall notify the Engineer, in writing, of his intent to begin work at least 72 hours before work is begun. The notice shall be delivered to the Transportation Department's Construction Engineer and shall specify the date the Contractor intends to start. If the project has more than one location of work, a separate notice shall be given for each location.

Should the Contractor begin work in advance of receiving a written "Notice to Proceed", any work performed by him in advance of the date stated in the "Notice to Proceed" shall be considered as having been done by him at his own risk and as a volunteer and subject to the following:

- (1) The Contractor shall, on commencing operations, take all precautions required for public safety and shall observe all the provisions in the Specifications and the Special Provisions.
 - (2) All work done according to the contract prior to the issuance of the "Notice to Proceed", will be considered authorized work and will be paid for as provided in the contract.
 - (3) The Contractor shall not be entitled to any additional compensation or an extension of time for any delay, hindrance or interference caused by or attributable to commencement of work prior to the issuance of the "Notice to Proceed".
4. Compensation. Contractor shall be paid in the manner set forth in the Contract Documents the amount of his Proposal as accepted by County, the above rates, subject to additions and deductions as provided in the Contract Documents. Said Proposal is on file in the Office of the Clerk of the Board of Supervisors of County.

**BROWN STREET
LOW WATER CROSSING AND STREET IMPROVEMENT PROJECT
FROM SOUDER STREET TO CAJALCO ROAD**

PROJECT No. C2-0013

AGREEMENT

ITEM No.	ITEM CODE	ITEM	UNIT	ESTIMATED QUANTITY	ITEM PRICE (IN FIGURES)	TOTAL (IN FIGURES)
BASE BID:						
1	066102	DUST ABATEMENT	LS	1	1,750.00	1,750.00
2	074020	WATER POLLUTION CONTROL	LS	1	3,500.00	3,500.00
3	120100	TRAFFIC CONTROL SYSTEM	LS	1	6,700.00	6,700.00
4	153210	REMOVE CONCRETE	LS	1	1,900.00	1,900.00
5	160101	CLEARING AND GRUBBING	LS	1	600.00	600.00
6	170101	DEVELOP WATER SUPPLY	LS	1	1,625.00	1,625.00
7	190101	ROADWAY EXCAVATION [INCLUDING GRINDING AC PAVEMENT]	CY	280	20.50	5,740.00
8	198001	IMPORTED BORROW	CY	820	13.25	10,865.00
9	260201	CLASS 2 AGGREGATE BASE	CY	262	46.50	12,183.00
10	390132	HOT MIX ASPHALT (TYPE A)	TON	320	93.50	29,920.00
11	193006	STRUCTURE BACKFILL (SLURRY CEMENT)	CY	36	139.50	5,022.00
12	401000	PORTLAND CEMENT CONCRETE PAVEMENT	CY	17	305.00	5,185.00
13	510501	MINOR CONCRETE (HEADWALL & WINGWALL)	CY	10	3,030.00	30,300.00
14	510502	MINOR CONCRETE (MINOR STRUCTURE - PCC DIP SECTION)	CY	62	330.00	20,460.00
15	862065	REPLACE PULL BOX [TRAFFIC BEARING]	EA	2	2,525.00	5,050.00
16	393001	PAVEMENT REINFORCING FABRIC (GEOTEXTILE FABRIC)	SQYD	1,860	3.00	5,580.00
17	566011	ROADSIDE SIGN - ONE POST	EA	6	225.00	1,350.00

AGREEMENT (Continued)

ITEM No.	ITEM CODE	ITEM	UNIT	ESTIMATED QUANTITY	ITEM PRICE (IN FIGURES)	TOTAL (IN FIGURES)
BASE BID:						
18	568017	ROADSIDE SIGN [INSTALL ON EXISTING POST]	EA	2	132.00	264.00
19	667013	28" X 20" CORRUGATED STEEL PIPE ARCH (0.079" THICK)	LF	113	68.00	7,684.00
20	721011	ROCK SLOPE PROTECTION (No.2, METHOD B)	CY	17	180.00	3,060.00
21	729010	ROCK SLOPE PROTECTION FABRIC	SQFT	520	2.65	1,378.00
22	860811	DETECTOR LOOP [REPLACE EXISTING]	EA	4	600.00	2,400.00
23	820107	DELINEATORS (CLASS 1) [SURFACE MOUNTED POST TUBE]	EA	28	37.50	1,050.00
24	840515	THERMOPLASTIC PAVEMENT MARKING	SQFT	150	8.00	1,200.00
25	840501	THERMOPLASTIC TRAFFIC STRIPE	LF	2,000	0.85	1,700.00
26	019901	DE-MOBILIZATION	LS	1	11,000.00	11,000.00

PROJECT

TOTAL: One hundred seventy seven thousand, four hundred sixty six dollars and zero cents **\$177,466.00**

ITEMS 1-26

"WORDS"

IN WITNESS WHEREOF the parties hereto have executed this agreement as of the date set forth below.

COUNTY OF RIVERSIDE

PANORAMA GENERAL ENGINEERING, INC.

BY _____
Chairman, Board of Supervisors
JOHN TAVAGLIONE

BY _____
[Signature]

Dated _____

TITLE: President
(If Corporation, Affix Seal)

ATTEST:
Kecia Harper-Ihem, Clerk of the Board

ATTEST:

David White

BY _____
Deputy

TITLE: VICE PRESIDENT

Licensed in accordance with an act providing for the registration of Contractors,

License No. 937187

Federal Employer Identification Number:

26-4812076

BY _____
"County"
(Seal)

"Corporation"
(Seal)

November 3, 2009

Certificate of Corporate Resolution

I, David L. White, Secretary of Panorama General Engineering, Inc do hereby certify that at a duly constituted meeting of the board of directors and shareholders of the corporation held at 1943 N. Campus Ave, Suite B 466 Upland, CA 91784 on November 02, 2009, it was upon motion and duly made and seconded, that it be voted:

Robert W. Dye, Jr. President/CEO and David L. White Secretary/CFO of the Corporation be empowered to sign and execute any documentation and contracts as a single individual signer as his discretion deems to be in the best interest of the Corporation.

I further certify that the foregoing votes are in full force without rescission, as modification or amendment.

Sincerely,

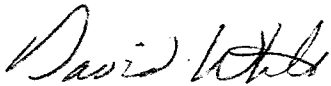

David L. White
Secretary/CFO
Panorama General Engineering, Inc.

PERFORMANCE BOND

Recitals:

1. **PANORAMA GENERAL ENGINEERING, INC.** (Contractor) has entered into an Agreement with COUNTY OF RIVERSIDE (County) for construction of public work known as **Brown Street Low Water Crossing And Street Improvement Project, From Souder Street To Cajalco Road, Mead Valley Area, Project No. C2-0013.**
2. _____, a _____ corporation (Surety), is the Surety under this Bond.

Agreement:

We, Contractor, as Principal, and Surety, as Surety, jointly and severally agree, state, and are bound unto County, as obligee, as follows:

1. The amount of the obligation of this Bond is 100% of the estimated contract price for the Project of \$ **177,466.00 (One hundred seventy seven thousand, four hundred sixty six dollars and zero cents)**, and inures to the benefit of County.
2. This Bond is exonerated by Contractor doing all things to be kept and performed by it in strict conformance with the Contract Documents for the Project, otherwise it remains in full force and effect for the recovery of loss, damage and expense of County resulting from failure of Contractor to so act. All of said Contract Documents are incorporated herein.
3. This obligation is binding on our successors and assigns.
4. For value received, Surety stipulates and agrees that no change, time extension, prepayment to Contractor, alteration or addition to the terms and requirements of the Contract Documents or the work to be performed thereunder shall affect its obligations hereunder and waives notice as to such matters, except the total contract price cannot be increased by more than 10% without approval of Surety.

THIS BOND is executed as of _____.

By _____

By _____

By _____

Type Name _____

Its Attorney in Fact
"Surety"

Title _____

"Contractor"

(Corporate Seal)

(Corporate Seal)

NOTE: This Bond must be executed by both parties with corporate seal affixed. All signatures must be acknowledged. (Attach acknowledgements).

PAYMENT BOND

(Public Work - Civil Code 3247 et seq.)

The makers of this Bond are **PANORAMA GENERAL ENGINEERING, INC.**, as Principal and Original Contractor and _____, a corporation, authorized to issue Surety Bonds in California, as Surety, and this Bond is issued in conjunction with that certain public works contract to be executed between Principal and **COUNTY OF RIVERSIDE** a public entity, as Owner, for \$ **177,466.00 (One hundred seventy seven thousand, four hundred sixty six dollars and zero cents)**, the total amount payable. THE AMOUNT OF THIS BOND IS ONE HUNDRED PERCENT OF SAID SUM. Said contract is for public work generally consisting of **Brown Street Low Water Crossing And Street Improvement Project, From Souder Street To Cajalco Road, Mead Valley Area, Project No. C2-0013.**

The beneficiaries of this Bond are as is stated in 3248 of the Civil Code and requirements and conditions of this Bond are as is set forth in 3248, 3249, 3250 and 3252 of said code. Without notice, Surety consents to extension of time for performance, change in requirements, amount of compensation, or prepayment under said contract.

DATED: _____

Original Contractor - Principal

Surety

By _____

By _____
Its Attorney In Fact

Title _____

(Corporate Seal)

(If corporation, affix seal)

(Corporate Seal)

STATE OF CALIFORNIA
COUNTY OF _____

} ss. SURETY'S ACKNOWLEDGEMENT

On _____ before me, _____ personally appeared, _____, known to me, or proved to me on the basis of satisfactory evidence, to be the person whose name is subscribed to the within instrument and acknowledged to me that he/she executed the same in his/her authorized capacities, and that by his/her signature on the instrument the person, or the entity upon behalf of which the person acted, executed the instrument.

WITNESS my hand and official seal.

Signature of Notary Public

Notary Public (Seal)

NOTE: This Bond must be executed by both parties with corporate seal affixed. All signatures must be acknowledged. (Attach acknowledgements).

PERFORMANCE BOND

Recitals:

1. **PANORAMA GENERAL ENGINEERING, INC.** (Contractor) has entered into an Agreement with COUNTY OF RIVERSIDE (County) for construction of public work known as **Brown Street Low Water Crossing And Street Improvement Project, From Souder Street To Cajalco Road, Mead Valley Area, Project No. C2-0013.**
2. Developers Surety and Indemnity Company, a n _____ Iowa _____ corporation (Surety), is the Surety under this Bond.

Agreement:

We, Contractor, as Principal, and Surety, as Surety, jointly and severally agree, state, and are bound unto County, as obligee, as follows:

1. The amount of the obligation of this Bond is 100% of the estimated contract price for the Project of \$ **177,466.00 (One hundred seventy seven thousand, four hundred sixty six dollars and zero cents)**, and inures to the benefit of County.
2. This Bond is exonerated by Contractor doing all things to be kept and performed by it in strict conformance with the Contract Documents for the Project, otherwise it remains in full force and effect for the recovery of loss, damage and expense of County resulting from failure of Contractor to so act. All of said Contract Documents are incorporated herein.
3. This obligation is binding on our successors and assigns.
4. For value received, Surety stipulates and agrees that no change, time extension, prepayment to Contractor, alteration or addition to the terms and requirements of the Contract Documents or the work to be performed thereunder shall affect its obligations hereunder and waives notice as to such matters, except the total contract price cannot be increased by more than 10% without approval of Surety.

THIS BOND is executed as of July 25, 2012

By _____

By  _____
Robert W. Dye, Jr

Title President
"Contractor"

By  _____

Type Name Scott Edward Pulido
Its Attorney in Fact
"Surety"

(Corporate Seal)

(Corporate Seal)

NOTE: This Bond must be executed by both parties with corporate seal affixed. All signatures must be acknowledged. (Attach acknowledgements).

CALIFORNIA ALL-PURPOSE ACKNOWLEDGMENT

CIVIL CODE § 1189

State of California

County of San Bernardino

On July 25, 2012 before me, Cathryn A. Yeager, Notary Public

personally appeared Robert W. Dye, Jr. Name(s) of Signer(s)

who proved to me on the basis of satisfactory evidence to be the person(s) whose name(s) is/are subscribed to the within instrument and acknowledged to me that he/she/they executed the same in his/her/their authorized capacity(ies), and that by his/her/their signature(s) on the instrument the person(s), or the entity upon behalf of which the person(s) acted, executed the instrument.

I certify under PENALTY OF PERJURY under the laws of the State of California that the foregoing paragraph is true and correct.

WITNESS my hand and official seal.

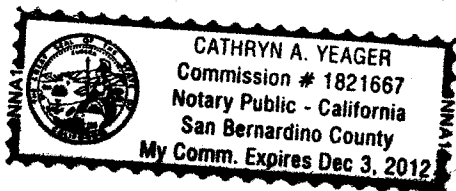

Place Notary Seal Above

Signature: Cathryn A. Yeager, Signature of Notary Public

OPTIONAL

Though the information below is not required by law, it may prove valuable to persons relying on the document and could prevent fraudulent removal and reattachment of this form to another document.

Description of Attached Document

Title or Type of Document:

Document Date: Number of Pages:

Signer(s) Other Than Named Above:

Capacity(ies) Claimed by Signer(s)

Signer's Name: Signer's Name:

Corporate Officer - Title(s): Corporate Officer - Title(s):

Individual Individual

Partner - Limited General Partner - Limited General

Attorney in Fact Attorney in Fact

Trustee Trustee

Guardian or Conservator Guardian or Conservator

Other: Other:

Signer Is Representing: Signer Is Representing:

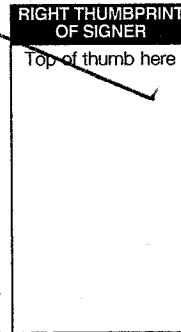
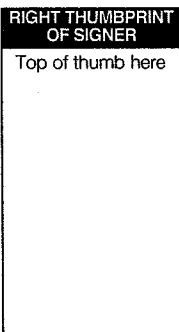

CALIFORNIA ALL-PURPOSE ACKNOWLEDGMENT

CIVIL CODE § 1189

State of California

County of San Bernardino

On July 25, 2012 before me, Cathryn A. Yeager, Notary
Date Here Insert Name and Title of the Officer

personally appeared Scott Edward Lulido
Name(s) of Signer(s)

who proved to me on the basis of satisfactory evidence to be the person(s) whose name(s) is/are subscribed to the within instrument and acknowledged to me that he/she/they executed the same in his/her/their authorized capacity(ies), and that by his/her/their signature(s) on the instrument the person(s), or the entity upon behalf of which the person(s) acted, executed the instrument.

I certify under PENALTY OF PERJURY under the laws of the State of California that the foregoing paragraph is true and correct.

WITNESS my hand and official seal.

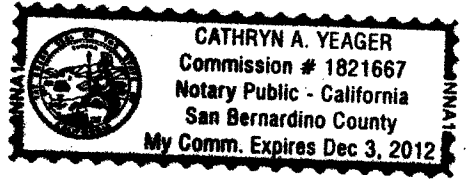

Place Notary Seal Above

Signature: Cathryn A. Yeager
Signature of Notary Public

OPTIONAL

Though the information below is not required by law, it may prove valuable to persons relying on the document and could prevent fraudulent removal and reattachment of this form to another document.

Description of Attached Document

Title or Type of Document: _____

Document Date: _____ Number of Pages: _____

Signer(s) Other Than Named Above: _____

Capacity(ies) Claimed by Signer(s)

Signer's Name: _____ Signer's Name: _____

Corporate Officer — Title(s): _____ Corporate Officer — Title(s): _____

Individual Individual

Partner — Limited General Partner — Limited General

Attorney in Fact Attorney in Fact

Trustee Trustee

Guardian or Conservator Guardian or Conservator

Other: _____ Other: _____

Signer Is Representing: _____ Signer Is Representing: _____

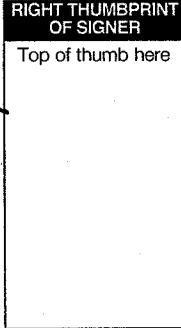
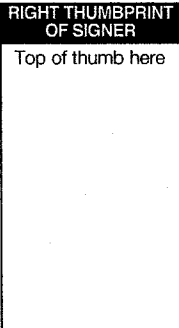

**POWER OF ATTORNEY FOR
DEVELOPERS SURETY AND INDEMNITY COMPANY
INDEMNITY COMPANY OF CALIFORNIA
PO Box 19725, IRVINE, CA 92623 (949) 263-3300**

KNOW ALL BY THESE PRESENTS that except as expressly limited, DEVELOPERS SURETY AND INDEMNITY COMPANY and INDEMNITY COMPANY OF CALIFORNIA, do each hereby make, constitute and appoint: ***Scott Edward Pulido***

as their true and lawful Attorney(s)-in-Fact, to make, execute, deliver and acknowledge, for and on behalf of said corporations, as sureties, bonds, undertakings and contracts of suretyship giving and granting unto said Attorney(s)-in-Fact full power and authority to do and to perform every act necessary, requisite or proper to be done in connection therewith as each of said corporations could do, but reserving to each of said corporations full power of substitution and revocation, and all of the acts of said Attorney(s)-in-Fact, pursuant to these presents, are hereby ratified and confirmed.

This Power of Attorney is granted and is signed by facsimile under and by authority of the following resolutions adopted by the respective Boards of Directors of DEVELOPERS SURETY AND INDEMNITY COMPANY and INDEMNITY COMPANY OF CALIFORNIA, effective as of January 1st, 2008.

RESOLVED, that a combination of any two of the Chairman of the Board, the President, Executive Vice-President, Senior Vice-President or any Vice President of the corporations be, and that each of them hereby is, authorized to execute this Power of Attorney, qualifying the attorney(s) named in the Power of Attorney to execute, on behalf of the corporations, bonds, undertakings and contracts of suretyship; and that the Secretary or any Assistant Secretary of either of the corporations be, and each of them hereby is, authorized to attest the execution of any such Power of Attorney;

RESOLVED, FURTHER, that the signatures of such officers may be affixed to any such Power of Attorney or to any certificate relating thereto by facsimile, and any such Power of Attorney or certificate bearing such facsimile signatures shall be valid and binding upon the corporations when so affixed and in the future with respect to any bond, undertaking or contract of suretyship to which it is attached.

IN WITNESS WHEREOF, DEVELOPERS SURETY AND INDEMNITY COMPANY and INDEMNITY COMPANY OF CALIFORNIA have severally caused these presents to be signed by their respective officers and attested by their respective Secretary or Assistant Secretary this October 4th, 2011.

By: *Daniel Young*
Daniel Young, Senior Vice-President

By: *Steve A. Tvedt*
Steve A. Tvedt, Vice-President

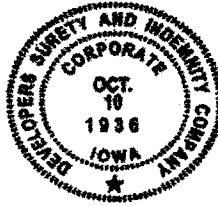

State of California
County of Orange

On October 4, 2011 before me, Antonio Alvarado, Notary Public
Date Here Insert Name and Title of the Officer

personally appeared Daniel Young and Steve A. Tvedt
Name(s) of Signer(s)

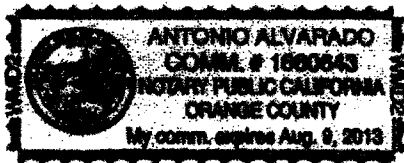

Place Notary Seal Above

who proved to me on the basis of satisfactory evidence to be the person(s) whose name(s) is/are subscribed to the within instrument and acknowledged to me that he/she/they executed the same in his/her/their authorized capacity(ies), and that by his/her/their signature(s) on the instrument the person(s), or the entity upon behalf of which the person(s) acted, executed the instrument.

I certify under PENALTY OF PERJURY under the laws of the State of California that the foregoing paragraph is true and correct.

WITNESS my hand and official seal.

Signature *Antonio Alvarado*
Antonio Alvarado, Notary Public

CERTIFICATE

The undersigned, as Secretary or Assistant Secretary of DEVELOPERS SURETY AND INDEMNITY COMPANY or INDEMNITY COMPANY OF CALIFORNIA, does hereby certify that the foregoing Power of Attorney remains in full force and has not been revoked and, furthermore, that the provisions of the resolutions of the respective Boards of Directors of said corporations set forth in the Power of Attorney are in force as of the date of this Certificate.

This Certificate is executed in the City of Irvine, California, this _____ day of _____

By: *Gregg N. Okura*
Gregg Okura, Assistant Secretary

Company Profile

DEVELOPERS SURETY AND INDEMNITY COMPANY

17771 COWAN, SUITE 100
IRVINE, CA 92614

Agent for Service of Process
SUSAN M. MOORE, 17771 COWAN SUITE 100 IRVINE, CA 92614
Unable to Locate the Agent for Service of Process?

Reference Information

NAIC #:	12718
NAIC Group #:	<u>0075</u>
California Company ID #:	4606-0
Date authorized in California:	August 30, 1999
License Status:	UNLIMITED-NORMAL
Company Type:	Property & Casualty
State of Domicile:	IOWA

Lines of Insurance Authorized to Transact

The company is authorized to transact business within these lines of insurance. For an explanation of any of these terms, please refer to the glossary.

AUTOMOBILE
BOILER AND MACHINERY
BURGLARY
FIRE
LEGAL INSURANCE
LIABILITY
MARINE
MISCELLANEOUS
PLATE GLASS
SPRINKLER
SURETY

Company Complaint Information

[Company Enforcement Action Documents](#)
[Company Performance & Comparison Data](#)
[Composite Complaint Studies](#)

Want More?

[Help Me Find a Company Representative in My Area](#)

Last Revised - June 05, 2012 12:07 PM
Copyright © California Department of Insurance

THIS BOND WAS EXECUTED
IN TWO IDENTICAL COUNTERPARTS

PAYMENT BOND

PREMIUM INCLUDED IN
PERFORMANCE BOND
BOND NO. 351641p

(Public Work - Civil Code 3247 et seq.)

The makers of this Bond are **PANORAMA GENERAL ENGINEERING, INC.**, as Principal and Original Contractor and Developers Surety and Indemnity Company, a corporation, authorized to issue Surety Bonds in California, as Surety, and this Bond is issued in conjunction with that certain public works contract to be executed between Principal and COUNTY OF RIVERSIDE a public entity, as Owner, for \$ **177,466.00 (One hundred seventy seven thousand, four hundred sixty six dollars and zero cents)**, the total amount payable. THE AMOUNT OF THIS BOND IS ONE HUNDRED PERCENT OF SAID SUM. Said contract is for public work generally consisting of **Brown Street Low Water Crossing And Street Improvement Project, From Souder Street To Cajalco Road, Mead Valley Area, Project No. C2-0013.**

The beneficiaries of this Bond are as is stated in 3248 of the Civil Code and requirements and conditions of this Bond are as is set forth in 3248, 3249, 3250 and 3252 of said code. Without notice, Surety consents to extension of time for performance, change in requirements, amount of compensation, or prepayment under said contract.

DATED: July 25, 2012

Panorama General Engineering, Inc
Original Contractor - Principal

Developers Surety and Indemnity Company
Surety

By 
Robert W. Dye, Jr

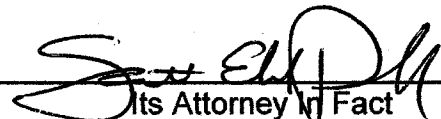
By 
Its Attorney In Fact
Scott Edward Pulido

Title President

(If corporation, affix seal)

(Corporate Seal)

(Corporate Seal)

STATE OF CALIFORNIA
COUNTY OF _____

} ss. SURETY'S ACKNOWLEDGEMENT

On _____ before me, _____ personally appeared, _____, known to me, or proved to me on the basis of satisfactory evidence, to be the person whose name is subscribed to the within instrument and acknowledged to me that he/she executed the same in his/her authorized capacities, and that by his/her signature on the instrument the person, or the entity upon behalf of which the person acted, executed the instrument.

WITNESS my hand and official seal.

Signature of Notary Public

Notary Public (Seal)

NOTE: This Bond must be executed by both parties with corporate seal affixed. All signatures must be acknowledged. (Attach acknowledgements).

CALIFORNIA ALL-PURPOSE ACKNOWLEDGMENT

CIVIL CODE § 1189

State of California

County of San Bernardino }

On July 25, 2012 before me, Cathryn A. Yeager, Notary Public

personally appeared Robert W. Ryan, Jr. Name(s) of Signer(s)

who proved to me on the basis of satisfactory evidence to be the person(s) whose name(s) is/are subscribed to the within instrument and acknowledged to me that he/she/they executed the same in his/her/their authorized capacity(ies), and that by his/her/their signature(s) on the instrument the person(s), or the entity upon behalf of which the person(s) acted, executed the instrument.

I certify under PENALTY OF PERJURY under the laws of the State of California that the foregoing paragraph is true and correct.

WITNESS my hand and official seal.

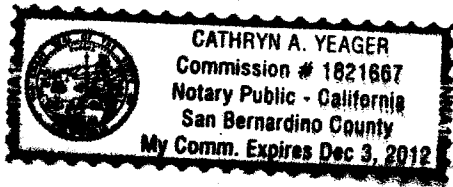

Signature: Cathryn A. Yeager Signature of Notary Public

Place Notary Seal Above

OPTIONAL

Though the information below is not required by law, it may prove valuable to persons relying on the document and could prevent fraudulent removal and reattachment of this form to another document.

Description of Attached Document

Title or Type of Document:

Document Date: Number of Pages:

Signer(s) Other Than Named Above:

Capacity(ies) Claimed by Signer(s)

Signer's Name:

- Corporate Officer -- Title(s):
Individual
Partner -- Limited General
Attorney in Fact
Trustee
Guardian or Conservator
Other:

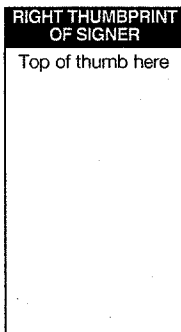

Signer Is Representing:

Signer's Name:

- Corporate Officer -- Title(s):
Individual
Partner -- Limited General
Attorney in Fact
Trustee
Guardian or Conservator
Other:

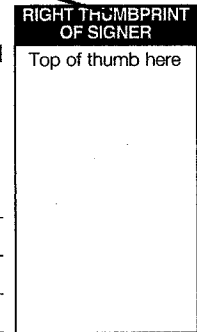

Signer Is Representing:

CALIFORNIA ALL-PURPOSE ACKNOWLEDGMENT

CIVIL CODE § 1189

State of California

County of San Bernardino }

On July 25, 2012 before me, Cathryn A. Yeager, Notary
Date Here Insert Name and Title of the Officer

personally appeared Scott Edward Lutich
Name(s) of Signer(s)

who proved to me on the basis of satisfactory evidence to be the person(s) whose name(s) is/are subscribed to the within instrument and acknowledged to me that he/she/they executed the same in his/her/their authorized capacity(ies), and that by his/her/their signature(s) on the instrument the person(s), or the entity upon behalf of which the person(s) acted, executed the instrument.

I certify under PENALTY OF PERJURY under the laws of the State of California that the foregoing paragraph is true and correct.

WITNESS my hand and official seal.



Place Notary Seal Above

Signature: Cathryn A. Yeager
Signature of Notary Public

OPTIONAL

Though the information below is not required by law, it may prove valuable to persons relying on the document and could prevent fraudulent removal and reattachment of this form to another document.

Description of Attached Document

Title or Type of Document: _____

Document Date: _____ Number of Pages: _____

Signer(s) Other Than Named Above: _____

Capacity(ies) Claimed by Signer(s)

Signer's Name: _____ Signer's Name: _____

Corporate Officer — Title(s): _____ Corporate Officer — Title(s): _____

Individual Individual

Partner — Limited General Partner — Limited General

Attorney in Fact Attorney in Fact

Trustee Trustee

Guardian or Conservator Guardian or Conservator

Other: _____ Other: _____

Signer Is Representing: _____ Signer Is Representing: _____

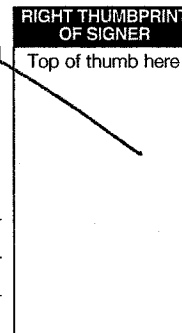
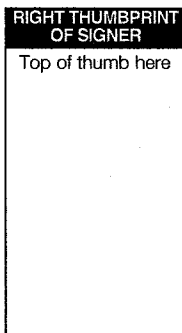

**POWER OF ATTORNEY FOR
DEVELOPERS SURETY AND INDEMNITY COMPANY
INDEMNITY COMPANY OF CALIFORNIA
PO Box 19725, IRVINE, CA 92623 (949) 263-3300**

KNOW ALL BY THESE PRESENTS that except as expressly limited, DEVELOPERS SURETY AND INDEMNITY COMPANY and INDEMNITY COMPANY OF CALIFORNIA, do each hereby make, constitute and appoint: *****Scott Edward Pulido*****

as their true and lawful Attorney(s)-in-Fact, to make, execute, deliver and acknowledge, for and on behalf of said corporations, as sureties, bonds, undertakings and contracts of suretyship giving and granting unto said Attorney(s)-in-Fact full power and authority to do and to perform every act necessary, requisite or proper to be done in connection therewith as each of said corporations could do, but reserving to each of said corporations full power of substitution and revocation, and all of the acts of said Attorney(s)-in-Fact, pursuant to these presents, are hereby ratified and confirmed.

This Power of Attorney is granted and is signed by facsimile under and by authority of the following resolutions adopted by the respective Boards of Directors of DEVELOPERS SURETY AND INDEMNITY COMPANY and INDEMNITY COMPANY OF CALIFORNIA, effective as of January 1st, 2008.

RESOLVED, that a combination of any two of the Chairman of the Board, the President, Executive Vice-President, Senior Vice-President or any Vice President of the corporations be, and that each of them hereby is, authorized to execute this Power of Attorney, qualifying the attorney(s) named in the Power of Attorney to execute, on behalf of the corporations, bonds, undertakings and contracts of suretyship; and that the Secretary or any Assistant Secretary of either of the corporations be, and each of them hereby is, authorized to attest the execution of any such Power of Attorney;

RESOLVED, FURTHER, that the signatures of such officers may be affixed to any such Power of Attorney or to any certificate relating thereto by facsimile, and any such Power of Attorney or certificate bearing such facsimile signatures shall be valid and binding upon the corporations when so affixed and in the future with respect to any bond, undertaking or contract of suretyship to which it is attached.

IN WITNESS WHEREOF, DEVELOPERS SURETY AND INDEMNITY COMPANY and INDEMNITY COMPANY OF CALIFORNIA have severally caused these presents to be signed by their respective officers and attested by their respective Secretary or Assistant Secretary this October 4th, 2011.

By: *Daniel Young*
Daniel Young, Senior Vice-President

By: *Steve A. Tvedt*
Steve A. Tvedt, Vice-President



State of California
County of Orange

On October 4, 2011 before me, Antonio Alvarado, Notary Public
Date Here Insert Name and Title of the Officer

personally appeared Daniel Young and Steve A. Tvedt
Name(s) of Signer(s)

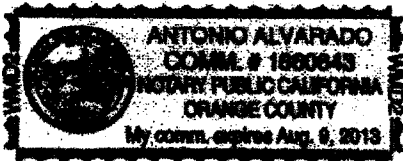

Place Notary Seal Above

who proved to me on the basis of satisfactory evidence to be the person(s) whose name(s) is/are subscribed to the within instrument and acknowledged to me that he/she/they executed the same in his/her/their authorized capacity(ies), and that by his/her/their signature(s) on the instrument the person(s), or the entity upon behalf of which the person(s) acted, executed the instrument.

I certify under PENALTY OF PERJURY under the laws of the State of California that the foregoing paragraph is true and correct.

WITNESS my hand and official seal.

Signature *Antonio Alvarado*
Antonio Alvarado, Notary Public

CERTIFICATE

The undersigned, as Secretary or Assistant Secretary of DEVELOPERS SURETY AND INDEMNITY COMPANY or INDEMNITY COMPANY OF CALIFORNIA, does hereby certify that the foregoing Power of Attorney remains in full force and has not been revoked and, furthermore, that the provisions of the resolutions of the respective Boards of Directors of said corporations set forth in the Power of Attorney are in force as of the date of this Certificate.

This Certificate is executed in the City of Irvine, California, this _____ day of _____

By: *Gregg Okura*
Gregg Okura, Assistant Secretary

Company Profile

DEVELOPERS SURETY AND INDEMNITY COMPANY

17771 COWAN, SUITE 100
IRVINE, CA 92614

Agent for Service of Process
SUSAN M. MOORE, 17771 COWAN SUITE 100 IRVINE, CA 92614
Unable to Locate the Agent for Service of Process?

Reference Information

NAIC #:	12718
NAIC Group #:	<u>0075</u>
California Company ID #:	4606-0
Date authorized in California:	August 30, 1999
License Status:	UNLIMITED-NORMAL
Company Type:	Property & Casualty
State of Domicile:	IOWA

Lines of Insurance Authorized to Transact

The company is authorized to transact business within these lines of insurance. For an explanation of any of these terms, please refer to the glossary.

AUTOMOBILE
BOILER AND MACHINERY
BURGLARY
FIRE
LEGAL INSURANCE
LIABILITY
MARINE
MISCELLANEOUS
PLATE GLASS
SPRINKLER
SURETY

Company Complaint Information

[Company Enforcement Action Documents](#)
[Company Performance & Comparison Data](#)
[Composite Complaint Studies](#)

Want More?

[Help Me Find a Company Representative in My Area](#)

Last Revised - June 05, 2012 12:07 PM
Copyright © California Department of Insurance