

**SUBMITTAL TO THE BOARD OF SUPERVISORS  
COUNTY OF RIVERSIDE, STATE OF CALIFORNIA**

187  
A



**FROM:** TLMA - Transportation Department

**SUBMITTAL DATE:**  
August 16, 2012

**SUBJECT:** Horsethief Canyon Road and Knabe Road Resurfacing projects, in the Temescal Valley area.

**RECOMMENDED MOTION:** That the Board of Supervisors:

1. Approve two Addenda to the specifications and plans, issued prior to the July 18, 2012 bid opening.
2. Accept the low bid of All American Asphalt, Inc. of Corona, CA in the amount of \$1,755,151.
3. Award the contract to All American Asphalt, Inc. and authorize the Chairman of the Board to execute the contract documents.
4. Approve the project's proposed budget as shown on Attachment A.

Juan C. Perez  
Director of Transportation and Land Management

JCP:jrj:sb  
(Continued On Attached Page)

<b>FINANCIAL DATA</b>	Current F.Y. Total Cost:	\$ 1,755,151	In Current Year Budget:	Yes
	Current F.Y. Net County Cost:	\$ 0	Budget Adjustment:	No
	Annual Net County Cost:	\$ 0	For Fiscal Year:	2012/2013

<b>SOURCE OF FUNDS:</b> ABX8 9 (Gas Tax Mar 2010) (33%), Proposition 1B (67%)	<b>Positions To Be Deleted Per A-30</b>	<input type="checkbox"/>
	<b>Requires 4/5 Vote</b>	<input type="checkbox"/>

There are no General Funds used in this project.

**C.E.O. RECOMMENDATION:**

APPROVE

BY   
Tina Grande

**County Executive Office Signature**

**MINUTES OF THE BOARD OF SUPERVISORS**

On motion of Supervisor Tavaglione, seconded by Supervisor Buster and duly carried, IT WAS ORDERED that the above matter is approved as recommended.

**Ayes:** Buster, Tavaglione, Benoit and Ashley  
**Nays:** None  
**Absent:** Stone  
**Date:** August 28, 2012  
**xc:** Tramps.

Kecia Harper-Ihem  
Clerk of the Board  
By:   
Deputy

**Prev. Agn. Ref.** 6/19/2012 Item 3.47 | **District:** 1<sup>st</sup>/1<sup>st</sup> | **Agenda Number:**

ATTACHMENTS FILED  
WITH THE CLERK OF THE BOARD

**3.103**

FORM APPROVED COUNTY COUNSEL  
BY:   
MARSHAL VICTOR  
DATE: 8/13/12

Departmental Concurrence

Dept't Recomm.:  Consent  Policy   
Per Exec. Ofc.:  Consent  Policy

The Honorable Board of Supervisors

RE: Horsethief Canyon Road and Knabe Road Resurfacing projects, in the Temescal Valley area.

August 16, 2012

Page 2 of 2

**BACKGROUND:** By Minute Order dated June 19, 2012 (Agenda Item 3.47), the Board authorized the Clerk of the Board to advertise for the Resurfacing of Horsethief Canyon Road and Knabe Road, in the Temescal Valley area.

During the advertisement period, two addenda were issued to all registered plan holders as a supplement to the specifications and special provisions. Bidders are required to acknowledge the addenda on their Contractor's Proposal, and to take the addenda into account in order to be considered for award. The addenda were issued to clarify and modify the approved contract documents. The addenda are attached as, Addendum No. 1 and Addendum No. 2.

Bids for the project were opened in the office of the Director of Transportation and Land Management at 2:00 PM, Wednesday, July 18, 2012. Five bids were received. The basis for the selection of a contractor is the lowest responsive and responsible bid for all schedules of work. The lowest responsive bid was submitted by All American Asphalt, Inc. in the amount of \$1,755,151, which is \$145,354 (7.65%) less than the Engineer's Estimate. Agreement includes the following schedules of work:

Base Bid: Primary items of work on Horsethief Canyon Road and Knabe Road.

Alternate Bid: Adjustment of manholes to be funded by Elsinore Valley Municipal Water District (EVMWD) and Lee Lake Water District (LLWD) for their respective utilities under the terms of the Cooperative Agreement.

The alternate bid is recommended to be awarded with the base bid contract. The utility owners, EVMWD and LLWD, have concurred with bid prices, as bid by the apparent low bidder. The alternate bid is included with the contract award and the costs for the work will be reimbursed by the respective utility owner.

The Transportation Improvement Program provides for the resurfacing of Horsethief Canyon Road and Knabe Road in the Temescal Valley area of Riverside County. The following are the limits of proposed work:

1. Horsethief Canyon Road: Temescal Canyon Road to Placid Hill Drive
2. Knabe Road: Forest Boundary Road to Clay Canyon Drive

The Contractor will execute the contract and provide bonds and insurance documents after Board approval. The Contractor is qualified to perform the work as outlined in the bid.

Project No. C2-0137 (Horsethief Canyon Road)  
C0-0523 (Knabe Road)

## AGREEMENT

THIS AGREEMENT is entered into at Riverside, California as of the date set forth below is between County of Riverside hereafter called "County" and **All American Asphalt** hereafter called "Contractor".

### WITNESSETH

#### RECITALS:

1. Contractor has submitted to County his Contractor's Proposal for the construction of County Project, **Horsethief Canyon Road and Knabe Road Resurfacing Projects in the Temescal Valley area of Riverside County, Project No. C2-0137 & C0-0523**, in strict accordance with the Contract Documents identified below and County has accepted said Proposal.
2. Contractor states that he has reexamined his Contractor's Proposal and found it to be correct, has ascertained that his subcontractors are properly licensed and possess the requisite skill and forces, has reexamined the site and Contract Documents and is of the opinion that he can presently do the work in accordance with the Contract Documents for the money set forth in his Proposal to be paid as provided in the Contract Documents.

#### AGREEMENT:

#### IT IS AGREED BY THE PARTIES AS FOLLOWS:

1. Contract Documents. The entire contract consists of the following: (a) The Agreement. (b) The Notice Inviting Bids. (c) The Instruction to Bidders. (d) The Contractor's Proposal. (e) The Bid Bond. (f) The Payment Bond. (g) The Performance Bond. (h) The General Conditions. (i) The Special Provisions. (j) The Standard Specifications of the State of California Department of Transportation edition of May 2006 as modified in other portions of the Contract Documents. (k) The Standard Plans of the Department of Transportation identified on the plans or in the Special Provisions. (l) The Plans. (m) Addenda (**two**). (n) The Determination of Prevailing Wage Rates for Public Work. (o) Any Change Orders issued. (p) Any additional or supplemental specifications, notice, instructions and drawings issued in accordance with the provisions of the Contract Documents. All of said Documents presently in existence are by this reference incorporated herein with like effect as if here set forth in full and upon the proper issuance of other documents they shall likewise be deemed incorporated. The Bid Bond is exonerated upon execution of this Agreement and the Payment Bond and Faithful Performance Bond.
2. The Work. Contractor shall do all things necessary to construct the work generally described in Recital No. 1 in accordance with the Contract Documents.

WHEN DOCUMENT IS FULLY EXECUTED RETURN  
**CLERK'S COPY**

to Riverside County Clerk of the Board, Stop 1010  
Post Office Box 1147, Riverside, Ca 92502-1147  
Thank you.

3. Liquidated Damages and Time of Completion. Attention is directed to the provisions in Section 8-1.06, "Time of Completion", and in Section 8-1.07, "Liquidated Damages", of the Standard Specifications and these Special Provisions.

The Contractor shall begin work within 15 days of the date stated within the written "Notice to Proceed".

The Contractor shall notify the Engineer, in writing, of his intent to begin work at least 72 hours before work is begun. The notice shall be delivered to the Transportation Department's Construction Engineer and shall specify the date the Contractor intends to start. If the project has more than one location of work, a separate notice shall be given for each location.

Should the Contractor begin work in advance of receiving a written "Notice to Proceed", any work performed by him in advance of the date stated in the "Notice to Proceed" shall be considered as having been done by him at his own risk and as a volunteer and subject to the following:

- (1) The Contractor shall, on commencing operations, take all precautions required for public safety and shall observe all the provisions in the Specifications and the Special Provisions.
  - (2) All work done according to the contract prior to the issuance of the "Notice to Proceed", will be considered authorized work and will be paid for as provided in the contract.
  - (3) The Contractor shall not be entitled to any additional compensation or an extension of time for any delay, hindrance or interference caused by or attributable to commencement of work prior to the issuance of the "Notice to Proceed".
4. Compensation. Contractor shall be paid in the manner set forth in the Contract Documents the amount of his Proposal as accepted by County, the above rates, subject to additions and deductions as provided in the Contract Documents. Said Proposal is on file in the Office of the Clerk of the Board of Supervisors of County.

**HORSETHIEF CANYON ROAD AND KNABE ROAD  
RESURFACING PROJECTS IN THE TEMESCAL VALLEY AREA OF  
RIVERSIDE COUNTY  
PROJECT No. C2-0137 & C0-0523**

**AGREEMENT**

**BASE BID**

ITEM No.	ITEM CODE	ITEM	UNIT	ESTIMATED QUANTITY	ITEM PRICE (IN FIGURES)	TOTAL (IN FIGURES)
1	066102	DUST ABATEMENT	LS	1	13,815.00	13,815.00
2	074020	WATER POLLUTION CONTROL	LS	1	2,500.00	2,500.00
3	120100	TRAFFIC CONTROL SYSTEM	LS	1	12,000.00	12,000.00
4	160101	CLEARING AND GRUBBING	LS	1	3,100.00	3,100.00
5	170101	DEVELOP WATER SUPPLY	LS	1	1,840.00	1,840.00
6	190101	ROADWAY EXCAVATION	CY	570	11.20	6,384.00
7	011506	WEDGE PLANE ASPHALT CONCRETE	LF	21,000	0.83	17,430.00
8	011506	WEDGE PLANE ASPHALT CONCRETE - MEDIAN	LF	3,000	0.83	2,490.00
9	153103	COLD PLANE ASPHALT CONCRETE PAVEMENT	SQYD	1,000	1.24	1,240.00
10	000003	COLD IN-PLACE RECYCLING - MIX DESIGN, SAMPLING & TESTING	LS	1	33,660.00	33,660.00
11	020256	EMULSIFIED RECYCLING AGENT	TON	560	684.00	383,040.00
12	020255	COLD IN-PLACE RECYCLING	SQYD	88,500	3.31	292,935.00
13	390130	HOT MIX ASPHALT	TON	610	69.00	42,090.00
14	013901	ASPHALT RUBBER HOT MIX	TON	10,300	71.30	734,390.00
15	013904	PLACE ASPHALT CONCRETE DIKE (CRS 212) (8")	LF	1,800	7.00	12,600.00
16	017305	MINOR CONCRETE (CURB AND GUTTER) (CRS 201)	LF	500	43.00	21,500.00
17	017306	MINOR CONCRETE (CURB RAMP) (CRS 403)	EA	36	2,300.00	82,800.00
18	017317	MINOR CONCRETE (CROSS-GUTTER AND SPANDREL)	SQFT	250	24.60	6,150.00
19	731521	MINOR CONCRETE (SIDEWALK)	SQFT	500	5.70	2,850.00
20	017003	REPAIR CATCH BASIN (CURB INLET) (CRS 300)	EA	1	8,800.00	8,800.00
21	840519	THERMOPLASTIC CROSSWALK AND PAVEMENT MARKING	SQFT	3,540	3.80	13,452.00
22	840656	PAINT TRAFFIC STRIPE (2-COAT)	LF	35,900	0.22	7,898.00
23	850111	PAVEMENT MARKER (RETROFLECTIVE)	EA	1,340	4.20	5,628.00

**AGREEMENT  
(CONTINUED)**

ITEM No.	ITEM CODE	ITEM	UNIT	ESTIMATED QUANTITY	ITEM PRICE (IN FIGURES)	TOTAL (IN FIGURES)
24	860811	DETECTOR LOOP	EA	26	184.00	4,784.00
25	152440	ADJUST STORM DRAIN MANHOLE TO GRADE	EA	17	560.00	9,520.00
26	566011	ROADSIDE SIGN - ONE POST	EA	39	231.00	9,009.00
27	150710	REMOVE TRAFFIC STRIPE	LF	1,000	1.00	1,000.00
28	000003	REMOVE AND SALVAGE SIGN AND POST	EA	10	52.00	520.00
29	000003	REPLACE EXISTING R1-1 ON EXISTING POST	EA	21	102.00	2,142.00
30	000003	FURNISH AND INSTALL STREET NAME SIGN (CRS 1220)	EA	12	372.00	4,464.00

**SUBTOTAL, BASE BID, ITEMS 1-30:**

One million, seven hundred forty thousand, thirty one dollars and zero cents      \$1,740,031.00  
"WORDS"

**ALTERNATE BID (EVMWD & LEE LAKE WATER)**

ITEM No.	ITEM CODE	ITEM	UNIT	ESTIMATED QUANTITY	ITEM PRICE (IN FIGURES)	TOTAL (IN FIGURES)
31	152475	ADJUST SEWER MH/CLEAN OUT TO GRADE - KNABE	EA	18	560.00	10,080.00
32	152475	ADJUST SEWER MH/CLEAN OUT TO GRADE - HORSETHIEF	EA	9	560.00	5,040.00

**SUBTOTAL, ALTERNATE BID, ITEMS 31-32:**

Fifteen thousand one hundred twenty dollars and zero cents.      \$ 15,120.00  
" Words"

**PROJECT TOTAL, ITEMS 1-32:**

One million, seven hundred fifty five thousand, one hundred fifty one dollars and zero cents.      \$ 1,755,151.00  
" Words"

HORSETHIEF CANYON ROAD AND KNABE ROAD  
RESURFACING PROJECTS IN THE TEMESCAL VALLEY AREA OF  
RIVERSIDE COUNTY  
PROJECT No. C2-0137 & C0-0523

IN WITNESS WHEREOF the parties hereto have executed this agreement as of the date set forth below.

COUNTY OF RIVERSIDE

ALL AMERICAN ASPHALT.

BY

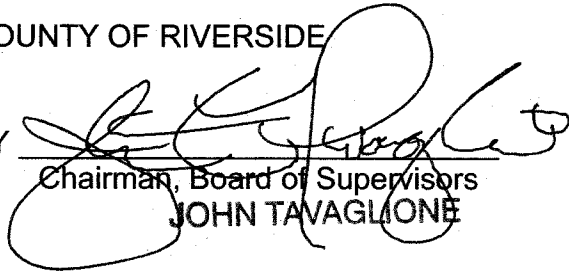
  
Chairman, Board of Supervisors  
JOHN TAVAGLIONE

BY \_\_\_\_\_

Dated

AUG 28 2012

TITLE: \_\_\_\_\_

(If Corporation, Affix Seal)

ATTEST:

Kecia Harper-Ihem, Clerk of the Board

ATTEST:  
\_\_\_\_\_  
\_\_\_\_\_

BY

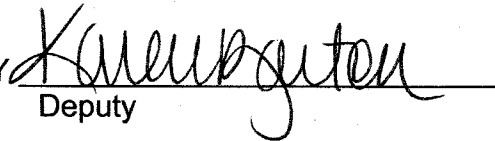
  
Deputy

TITLE: \_\_\_\_\_

Licensed in accordance with an act providing for the registration of Contractors,

License No. \_\_\_\_\_

Federal Employer Identification Number:  
\_\_\_\_\_

BY \_\_\_\_\_

"County"  
(Seal)

"Corporation"  
(Seal)



# ALL AMERICAN ASPHALT ALL AMERICAN AGGREGATES

---

---

P.O. BOX 2229, CORONA, CA 92878-2229  
STATE CONTRACTORS LICENSE #267073-A

## CORPORATE RESOLUTION

Resolved, that this Corporation, All American Asphalt, on June 1, 2012 authorizes Robert Bradley to execute contracts and agreements on behalf of the Company in the capacity of Vice President.

A handwritten signature in black ink, appearing to be "MF", written over a horizontal line.

Michael Farkas  
Secretary



**PERFORMANCE BOND**

**Recitals:**

1. **All American Asphalt** (Contractor) has entered into an Agreement with COUNTY OF RIVERSIDE (County) for construction of public work known as **Horsethief Canyon Road and Knabe Road Resurfacing Projects in the Temescal Valley area of Riverside County, Project No. C2-0137 & C0-0523**
2. \_\_\_\_\_, a \_\_\_\_\_ corporation (Surety), is the Surety under this Bond.

**Agreement:**

We, Contractor, as Principal, and Surety, as Surety, jointly and severally agree, state, and are bound unto County, as obligee, as follows:

1. The amount of the obligation of this Bond is 100% of the estimated contract price for the Project of \$ **1,755,151.00 (One million seven hundred fifty five thousand, one hundred fifty one dollars and zero cents)**, and inures to the benefit of County.
2. This Bond is exonerated by Contractor doing all things to be kept and performed by it in strict conformance with the Contract Documents for the Project, otherwise it remains in full force and effect for the recovery of loss, damage and expense of County resulting from failure of Contractor to so act. All of said Contract Documents are incorporated herein.
3. This obligation is binding on our successors and assigns.
4. For value received, Surety stipulates and agrees that no change, time extension, prepayment to Contractor, alteration or addition to the terms and requirements of the Contract Documents or the work to be performed thereunder shall affect its obligations hereunder and waives notice as to such matters, except the total contract price cannot be increased by more than 10% without approval of Surety.

THIS BOND is executed as of \_\_\_\_\_.

By \_\_\_\_\_

By \_\_\_\_\_

By \_\_\_\_\_

Type Name \_\_\_\_\_

Its Attorney in Fact  
"Surety"

Title \_\_\_\_\_

"Contractor"

**(Corporate Seal)**

**(Corporate Seal)**

**NOTE: This Bond must be executed by both parties with corporate seal affixed for each party. All signatures must be acknowledged. (Attach acknowledgements).**

**PAYMENT BOND**

(Public Work - Civil Code 3247 et seq.)

The makers of this Bond are **All American Asphalt** as Principal and Original Contractor and \_\_\_\_\_, a corporation, authorized to issue Surety Bonds in California, as Surety, and this Bond is issued in conjunction with that certain public works contract to be executed between Principal and **COUNTY OF RIVERSIDE** a public entity, as Owner, for \$ **1,755,151.00 (One million seven hundred fifty five thousand, one hundred fifty one dollars and zero cents)**, the total amount payable. THE AMOUNT OF THIS BOND IS ONE HUNDRED PERCENT OF SAID SUM. Said contract is for public work generally consisting of **Horsethief Canyon Road and Knabe Road Resurfacing Projects in the Temescal Valley area of Riverside County, Project No. C2-0137 & C0-0523**

The beneficiaries of this Bond are as is stated in 3248 of the Civil Code and requirements and conditions of this Bond are as is set forth in 3248, 3249, 3250 and 3252 of said code. Without notice, Surety consents to extension of time for performance, change in requirements, amount of compensation, or prepayment under said contract.

DATED: \_\_\_\_\_

\_\_\_\_\_  
Original Contractor - Principal

\_\_\_\_\_  
Surety

By \_\_\_\_\_

By \_\_\_\_\_  
Its Attorney In Fact

Title \_\_\_\_\_

(Corporate Seal)

(If corporation, affix seal)

(Corporate Seal)

STATE OF CALIFORNIA  
COUNTY OF \_\_\_\_\_

} ss. SURETY'S ACKNOWLEDGEMENT

On \_\_\_\_\_ before me, \_\_\_\_\_ personally appeared, \_\_\_\_\_, known to me, or proved to me on the basis of satisfactory evidence, to be the person whose name is subscribed to the within instrument and acknowledged to me that he/she executed the same in his/her authorized capacities, and that by his/her signature on the instrument the person, or the entity upon behalf of which the person acted, executed the instrument.

WITNESS my hand and official seal.

\_\_\_\_\_  
Signature of Notary Public

Notary Public (Seal)

**NOTE: This Bond must be executed by both parties with corporate seal affixed for each party. All signatures must be acknowledged. (Attach acknowledgements).**

# Form 11 Attachment

## Contract/Lease/Purchase Summary Data

**Contract (for Services)**

- Approval/Renewal
- Sole Source
- Personal Services
- Independent Contractor
- Other than Low Bid
- Change Order
- Public Works

**Lease**

- Approval/Renewal
- Multi-Year Lease
- Equipment
- Real Property
- Change Order

**Purchase (for Materials)**

- Sole Source
- Other than Low Bid
- Change Order

**Selection Committee Member Names (RFP's Only)**

<b>User Department:</b>	<b>Transportation Department</b>
-------------------------	----------------------------------

N/A

<b>Vendor/Lessor Name:</b>	<b>All American Asphalt</b>
----------------------------	-----------------------------

**Minority Status:**

- M     W     DV     None

<b>Vendor/Lessor Location:</b>	<b>Corona, Ca.</b>
--------------------------------	--------------------

**Local Preference Applied:**     Yes     No     N/A

Local Preference Award Cost \$  
(5% maximum preference)

Local Preference FYTD: Cost \$

# of Orders

**Applicable Board Policy #**

**Comments:**

**RFQ/RFP Process:**

Date Mailed:  
Response Date:  
# of Responses:  
# of Qualified Responses:

**Bidding Process:**

Bid Range:                                \$ 1,755,151.00 to \$2,051,588.00  
Local Bid Range:                                N/A  
Responsive and Responsible Bid Range:        \$ 1,755,151.00 to \$2,051,588.00

**Contract/Lease Renewals Only**

Existing Agreement Items

Proposed Agreement Items

1. Rates
2. Terms
3. Conditions
4. Legal Issues
5. Accountability
6. Utilities

(continue on blank sheet if necessary)

**NOTE: COMPETITIVELY BID PUBLIC WORKS CONTRACT**

# Attachment "A"

Riverside County Transportation Department

Project: **KNABE RD**

Project No.(s): **C0-0523**

Expenses as of: **7/30/2012**

### Project Costs and Budget

Activity	Incurred Costs	Projected Costs	Total Costs	Existing Budget	Proposed Budget
Preliminary Survey					
Environmental	280		1,000	1,000	1,000
Design	46,463	1,537	48,000	35,000	48,000
Right-of-way					
Utilities					
Construction		830,343			
Construction Contingency	10.0%	83,034	914,000	600,000	914,000
Construction Engineering & Inspection	7.5%	430	62,570	65,000	63,000
Construction Survey	3.3%	27,000	27,000	11,000	27,000
<b>Totals:</b>	<b>47,173</b>	<b>1,004,484</b>	<b>1,053,000</b>	<b>712,000</b>	<b>1,053,000</b>

### Project Funding

Code	Name	Existing Budget	Proposed Budget
221	ABX8 9 (Gas Tax Mar 2010)	712,000	673,000
215	Proposition 1B (State bond funds- Local Roads)		380,000
<b>Totals</b>		<b>712,000</b>	<b>1,053,000</b>

### Comments

UPDATED WITH ALL AMERICAN ASPHALT JULY 18, 2012 BID COSTS.

# Attachment "A"

Riverside County Transportation Department

Project: **HORSETHIEF CANYON RD**

Project No.(s): **C2-0137**

Expenses as of: **7/30/2012**

### Project Costs and Budget

Activity	Incurred Costs	Projected Costs	Total Costs	Existing Budget	Proposed Budget
Preliminary Survey					
Environmental	280		1,000	2,000	1,000
Design	56,568	2,432	59,000	61,000	59,000
Right-of-way					
Utilities					
Construction		924,809			
Construction Contingency	10.0%		1,018,000	1,203,000	1,018,000
Construction Engineering & Inspection	7.6%	500	70,000	61,000	71,000
Construction Survey	3.2%		30,000	13,000	30,000
<b>Totals:</b>	<b>57,348</b>	<b>1,119,722</b>	<b>1,179,000</b>	<b>1,340,000</b>	<b>1,179,000</b>

### Project Funding

Code	Name	Existing Budget	Proposed Budget
221	ABX8 9 (Gas Tax Mar 2010)	63,000	60,000
999	Unfunded	1,277,000	
215	Proposition 1B (State bond funds- Local Roads)		1,119,000
<b>Totals</b>		<b>1,340,000</b>	<b>1,179,000</b>

### Comments

UPDATED WITH ALL AMERICAN ASPHALT JULY 18, 2012 BID COSTS.

COUNTY OF RIVERSIDE  
 DEPARTMENT OF TRANSPORTATION

**HORSETHIEF CANYON ROAD**  
 RESURFACING PROJECT

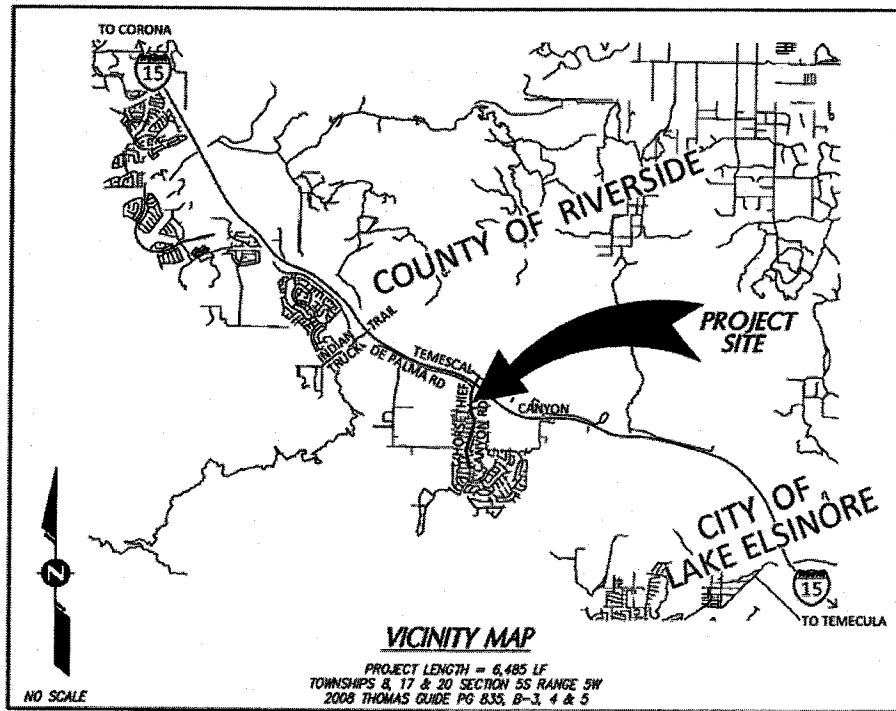
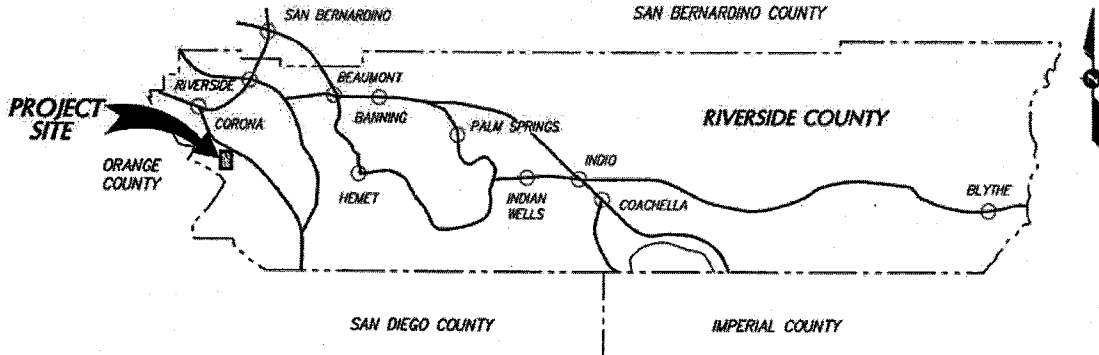

VICINITY MAP
SCALE NONE
EXHIBIT "A"

**HORSETHIEF CANYON RD**  
**RESURFACING PROJECT**

COUNTY OF RIVERSIDE  
 DEPARTMENT OF TRANSPORTATION

KNABE ROAD  
 RESURFACING PROJECT

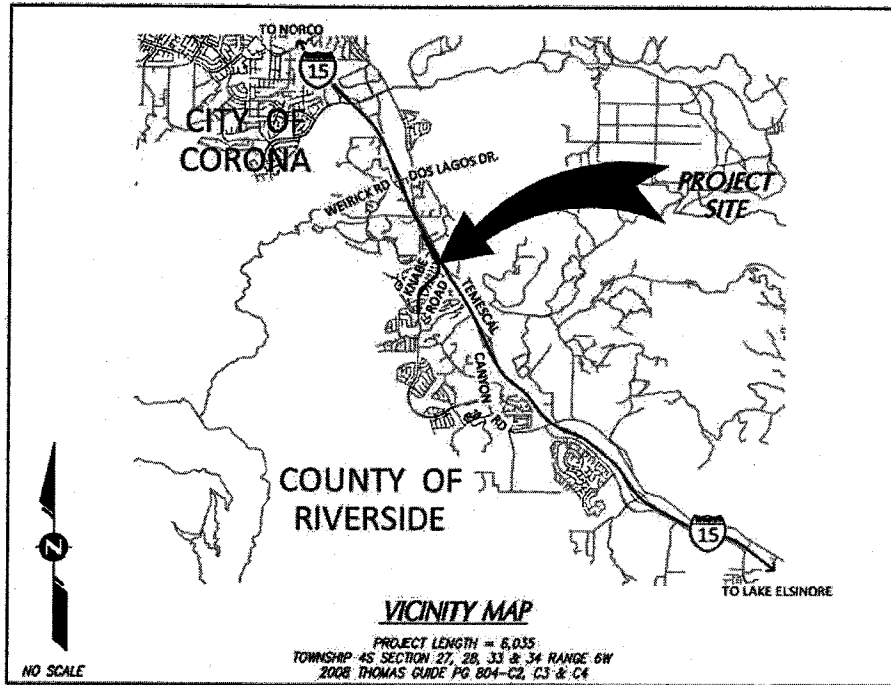
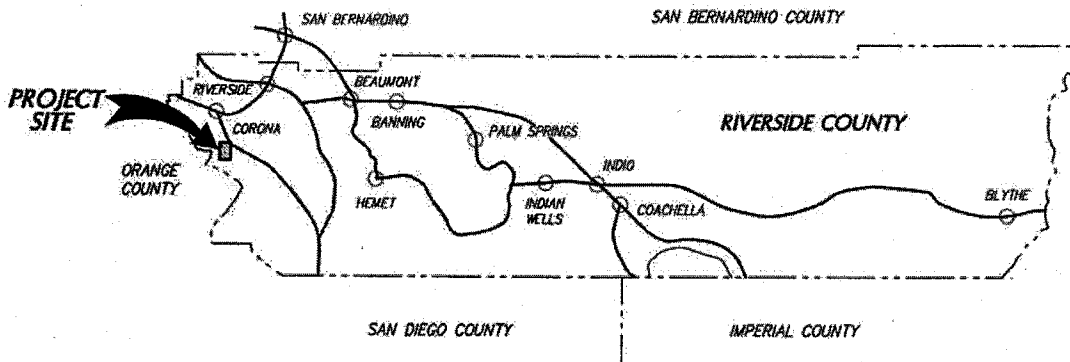

VICINITY MAP
SCALE NONE
EXHIBIT "A"

**KNABE RD**  
**RESURFACING PROJECT**

**Riverside County Transportation Department  
Summary of Bids**

**PROJECT: Horsethief Canyon Road and Knabe Road Resurfacing Project  
in the Temescal Valley area of Riverside County**

Advertised: June 19, 2012 (Agenda Item: 3.47)

Addenda: 1(7/10/12), 2(7/12/12)

Bids Open: 2 pm Date: Wednesday, July 18, 2012

PROJECT NO. C2-0137 & C0-0523

BASE BID		COUNTY'S ESTIMATE				COUNTY'S ESTIMATE		All American Asphalt Corona, CA 92878	
ITEM NO.	ITEM CODE	CONTRACT ITEM	UNITS	QUANTITY	UNIT PRICE	ENG ESTIMATE	BID UNIT PRICE	BID ESTIMATE	
1	066102	DUST ABATEMENT	LS	1	5,000.00	5,000.00	13,815.00	13,815.00	
2	074020	WATER POLLUTION CONTROL	LS	1	10,000.00	10,000.00	2,500.00	2,500.00	
3	120100	TRAFFIC CONTROL SYSTEM	LS	1	40,000.00	40,000.00	12,000.00	12,000.00	
4	160101	CLEARING AND GRUBBING	LS	1	10,000.00	10,000.00	3,100.00	3,100.00	
5	170101	DEVELOP WATER SUPPLY	LS	1	5,000.00	5,000.00	1,840.00	1,840.00	
6	190101	ROADWAY EXCAVATION	CY	570	30.00	17,100.00	11.20	6,384.00	
7	011506	WEDGE PLANE ASPHALT CONCRETE	LF	21,000	1.00	21,000.00	0.83	17,430.00	
8	011506	WEDGE PLANE ASPHALT CONCRETE - MEDIUM	LF	3,000	1.00	3,000.00	0.83	2,490.00	
9	153103	COLD PLANE ASPHALT CONCRETE PAVEMENT	SQYD	1,000	2.00	2,000.00	1.24	1,240.00	
10	000003	COLD IN-PLACE RECYCLING - MIX DESIGN, SAMPLING & TESTING	LS	1	12,000.00	12,000.00	33,660.00	33,660.00	
11	020256	EMULSIFIED RECYCLING AGENT	TON	560	650.00	364,000.00	684.00	383,040.00	
12	020255	COLD IN-PLACE RECYCLING	SQYD	88,500	4.50	398,250.00	3.31	292,935.00	
13	390130	HOT MIX ASPHALT	TON	610	70.00	42,700.00	69.00	42,090.00	
14	013901	ASPHALT RUBBER HOT MIX	TON	10,300	75.00	772,500.00	71.30	734,390.00	
15	013904	PLACE ASPHALT CONCRETE DIKE (CRS 212) (8")	LF	1,800	6.00	10,800.00	7.00	12,600.00	
16	017305	MINOR CONCRETE (CURB AND GUTTER) (CRS 201)	LF	500	25.00	12,500.00	43.00	21,500.00	
17	017306	MINOR CONCRETE (CURB RAMP) (CRS 403)	EA	36	2,500.00	90,000.00	2,300.00	82,800.00	
18	017317	MINOR CONCRETE (CROSS-GUTTER AND SPANDREL)	SQFT	250	10.00	2,500.00	24.60	6,150.00	
19	731521	MINOR CONCRETE (SIDEWALK)	SQFT	500	4.00	2,000.00	5.70	2,850.00	
20	017003	REPAIR CATCH BASIN (CURB INLET) (CRS 300)	EA	1	850.00	850.00	8,800.00	8,800.00	
21	840519	THERMOPLASTIC CROSSWALK AND PAVEMENT MARKING	SQFT	3,540	4.00	14,160.00	3.80	13,452.00	
22	840656	PAINT TRAFFIC STRIPE (2-COAT)	LF	35,900	0.40	14,360.00	0.22	7,898.00	
23	850111	PAVEMENT MARKER (RETROREFLECTIVE)	EA	1,340	4.00	5,360.00	4.20	5,628.00	
24	860811	DETECTOR LOOP	EA	26	250.00	6,500.00	184.00	4,784.00	
25	152440	ADJUST STORM DRAIN MANHOLE TO GRADE	EA	17	500.00	8,500.00	560.00	9,520.00	
26	566011	ROADSIDE SIGN - ONE POST	EA	39	250.00	9,750.00	231.00	9,009.00	
27	150710	REMOVE TRAFFIC STRIPE	LF	1,000	2.00	2,000.00	1.00	1,000.00	
28	000003	REMOVE AND SALVAGE SIGN AND POST	EA	10	75.00	750.00	52.00	520.00	
29	000003	REPLACE EXISTING R1-1 ON EXISTING POST	EA	21	125.00	2,625.00	102.00	2,142.00	
30	000003	FURNISH AND INSTALL STREET NAME SIGN (CRS 1220)	EA	12	150.00	1,800.00	372.00	4,464.00	
<b>SUBTOTAL (Base Bid)</b>						<b>1,887,005.00</b>		<b>1,740,031.00</b>	
<b>ITEMS 1-30</b>									



**Riverside County Transportation Department  
Summary of Bids**

**PROJECT: Horsethief Canyon Road and Knabe Road Resurfacing Project  
in the Temescal Valley area of Riverside County**

Advertised: June 19, 2012 (Agenda Item: 3.47)

Addenda: 1(7/10/12), 2(7/12/12)

Bids Open: 2 pm Date: Wednesday, July 18, 2012

PROJECT NO. C2-0137 & C0-0523

ALTERNATE BID (EVMWD & LEE LAKE WATER)		COUNTY'S ESTIMATE				All American Asphalt Corona, CA 92878		
ITEM NO.	ITEM CODE	CONTRACT ITEM	UNITS	QUANTITY	UNIT PRICE	ENG ESTIMATE	BID UNIT PRICE	BID ESTIMATE
31	152475	ADJUST SEWER MH/CLEAN OUT TO GRADE - KNABE	EA	18	500.00	9,000.00	560.00	10,080.00
32	152475	ADJUST SEWER MH/CLEAN OUT TO GRADE - HORSETHIEF	EA	9	500.00	4,500.00	560.00	5,040.00
		<b>SUBTOTAL (Alternate Bid)</b>				<b>13,500.00</b>		<b>15,120.00</b>
		<b>ITEM 31-32</b>						

	<b>PROJECT TOTAL</b>					<b>1,900,505.00</b>		<b>1,755,151.00</b>
	<b>ITEMS 1-32</b>							

**Riverside County Transportation Department  
Summary of Bids**

**PROJECT: Horsethief Canyon Road and Knabe Road Resurfacing Project  
in the Temescal Valley area of Riverside County**

Advertised: June 19, 2012 (Agenda Item: 3.47)

Addenda: 1(7/10/12), 2(7/12/12)

Bids Open: 2 pm Date: Wednesday, July 18, 2012

PROJECT NO. C2-0137 & C0-0523

BASE BID ITEM NO.	ITEM CODE	CONTRACT ITEM	UNITS	QUANTITY	2		3	
					R.J Noble Company Orange, CA 92856	BID ESTIMATE	Hardy & Harper, Inc. Santa Ana, CA 92705	BID ESTIMATE
					BID UNIT PRICE	BID ESTIMATE	BID UNIT PRICE	BID ESTIMATE
1	066102	DUST ABATEMENT	LS	1	4,500.00	4,500.00	6,000.00	6,000.00
2	074020	WATER POLLUTION CONTROL	LS	1	3,000.00	3,000.00	3,000.00	3,000.00
3	120100	TRAFFIC CONTROL SYSTEM	LS	1	16,500.00	16,500.00	66,000.00	66,000.00
4	160101	CLEARING AND GRUBBING	LS	1	8,500.00	8,500.00	24,000.00	24,000.00
5	170101	DEVELOP WATER SUPPLY	LS	1	4,000.00	4,000.00	6,000.00	6,000.00
6	190101	ROADWAY EXCAVATION	CY	570	23.75	13,537.50	30.75	17,527.50
7	011506	WEDGE PLANE ASPHALT CONCRETE	LF	21,000	0.87	18,270.00	1.00	21,000.00
8	011506	WEDGE PLANE ASPHALT CONCRETE - MEDIAN	LF	3,000	0.87	2,610.00	1.50	4,500.00
9	153103	COLD PLANE ASPHALT CONCRETE PAVEMENT	SQYD	1,000	1.30	1,300.00	1.50	1,500.00
10	000003	COLD IN-PLACE RECYCLING - MIX DESIGN, SAMPLING & TESTING	LS	1	34,000.00	34,000.00	52,002.50	52,002.50
11	020256	EMULSIFIED RECYCLING AGENT	TON	560	690.00	386,400.00	699.00	391,440.00
12	020255	COLD IN-PLACE RECYCLING	SQYD	88,500	3.68	325,680.00	3.21	284,085.00
13	390130	HOT MIX ASPHALT	TON	610	59.00	35,990.00	67.00	40,870.00
14	013901	ASPHALT RUBBER HOT MIX	TON	10,300	71.20	733,360.00	75.50	777,650.00
15	013904	PLACE ASPHALT CONCRETE DIKE (CRS 212) (8')	LF	1,800	3.80	6,840.00	4.00	7,200.00
16	017305	MINOR CONCRETE (CURB AND GUTTER) (CRS 201)	LF	500	32.00	16,000.00	35.00	17,500.00
17	017306	MINOR CONCRETE (CURB RAMP) (CRS 403)	EA	36	2,050.00	73,800.00	1,900.00	68,400.00
18	017317	MINOR CONCRETE (CROSS-GUTTER AND SPANDREL)	SQFT	250	15.50	3,875.00	12.00	3,000.00
19	731521	MINOR CONCRETE (SIDEWALK)	SQFT	500	5.50	2,750.00	5.50	2,750.00
20	017003	REPAIR CATCH BASIN (CURB INLET) (CRS 300)	EA	1	9,000.00	9,000.00	4,000.00	4,000.00
21	840519	THERMOPLASTIC CROSSWALK AND PAVEMENT MARKING	SQFT	3,540	3.35	11,859.00	3.75	13,275.00
22	840656	PAINT TRAFFIC STRIPE (2-COAT)	LF	35,900	0.29	10,411.00	0.24	8,616.00
23	850111	PAVEMENT MARKER (RETROREFLECTIVE)	EA	1,340	3.10	4,154.00	4.00	5,360.00
24	860811	DETECTOR LOOP	EA	26	185.00	4,810.00	225.00	5,850.00
25	152440	ADJUST STORM DRAIN MANHOLE TO GRADE	EA	17	465.00	7,905.00	600.00	10,200.00
26	566011	ROADSIDE SIGN - ONE POST	EA	39	230.00	8,970.00	230.00	8,970.00
27	150710	REMOVE TRAFFIC STRIPE	LF	1,000	1.80	1,800.00	1.30	1,300.00
28	000003	REMOVE AND SALVAGE SIGN AND POST	EA	10	80.00	800.00	55.00	550.00
29	000003	REPLACE EXISTING R1-1 ON EXISTING POST	EA	21	115.00	2,415.00	130.00	2,730.00
30	000003	FURNISH AND INSTALL STREET NAME SIGN (CRS 1220)	EA	12	205.00	2,460.00	377.00	4,524.00
<b>SUBTOTAL (Base Bid)</b>						<b>1,755,496.50</b>		<b>1,859,800.00</b>
<b>ITEMS 1-30</b>								

**Riverside County Transportation Department  
Summary of Bids**

**PROJECT: Horsethief Canyon Road and Knabe Road Resurfacing Project  
in the Temescal Valley area of Riverside County**

Advertised: June 19, 2012 (Agenda Item: 3.47)

Addenda: 1(7/10/12), 2(7/12/12)

Bids Open: 2 pm Date: Wednesday, July 18, 2012

PROJECT NO. C2-0137 & C0-0523

ALTERNATE BID (EVMWD & LEE LAKE WATER)	ITEM NO.	ITEM CODE	CONTRACT ITEM	UNITS	QUANTITY	2		3	
						R.J Noble Company Orange, CA 92856	BID UNIT PRICE	BID ESTIMATE	Hardy & Harper, Inc. Santa Ana, CA 92705
	31	152475	ADJUST SEWER MH/CLEAN OUT TO GRADE - KNABE	EA	18	465.00	8,370.00	600.00	10,800.00
	32	152475	ADJUST SEWER MH/CLEAN OUT TO GRADE - HORSETHIEF	EA	9	465.00	4,185.00	600.00	5,400.00
			SUBTOTAL (Alternate Bid)				12,555.00		16,200.00
			ITEM 31-32						

			PROJECT TOTAL				1,768,051.50		1,876,000.00
			ITEMS 1-32						

**Riverside County Transportation Department  
Summary of Bids**

**PROJECT: Horsethief Canyon Road and Knabe Road Resurfacing Project  
in the Temescal Valley area of Riverside County**

Advertised: June 19, 2012 (Agenda Item: 3.47)  
Addenda: 1(7/10/12), 2(7/12/12)  
Bids Open: 2 pm Date: Wednesday, July 18, 2012

**PROJECT NO. C2-0137 & C0-0523**

BASE BID		4		5		
ITEM NO.	ITEM CODE	CONTRACT ITEM	UNITS	QUANTITY	Silvia Construction, Inc. Rancho Cucamonga, CA 91730	Sully-Miller Contracting Company Brea, CA 92821
					BID UNIT PRICE	BID ESTIMATE
1	066102	DUST ABATEMENT	LS	1	5,000.00	3,500.00
2	074020	WATER POLLUTION CONTROL	LS	1	3,300.00	2,800.00
3	120100	TRAFFIC CONTROL SYSTEM	LS	1	75,750.00	32,000.00
4	160101	CLEARING AND GRUBBING	LS	1	10,000.00	2,500.00
5	170101	DEVELOP WATER SUPPLY	LS	1	4,700.00	3,996.00
6	190101	ROADWAY EXCAVATION	CY	570	32.60	37.00
7	011506	WEDGE PLANE ASPHALT CONCRETE	LF	21,000	0.70	1.10
8	011506	WEDGE PLANE ASPHALT CONCRETE - MEDIAN	LF	3,000	0.70	2.20
9	153103	COLD PLANE ASPHALT CONCRETE PAVEMENT	SQYD	1,000	1.07	3.30
10	000003	COLD IN-PLACE RECYCLING - MIX DESIGN, SAMPLING & TESTING	LS	1	38,900.00	75,000.00
11	020256	EMULSIFIED RECYCLING AGENT	TON	560	701.20	805.00
12	020255	COLD IN-PLACE RECYCLING	SQYD	88,500	4.17	2.80
13	390130	HOT MIX ASPHALT	TON	610	73.50	79.70
14	013901	ASPHALT RUBBER HOT MIX	TON	10,300	76.20	91.70
15	013904	PLACE ASPHALT CONCRETE DIKE (CRS 212) (8")	LF	1,800	4.45	6.00
16	017305	MINOR CONCRETE (CURB AND GUTTER) (CRS 201)	LF	500	32.30	24.00
17	017306	MINOR CONCRETE (CURB RAMP) (CRS 403)	EA	36	3,690.00	2,100.00
18	017317	MINOR CONCRETE (CROSS-GUTTER AND SPANDREL)	SQFT	250	12.40	11.00
19	731521	MINOR CONCRETE (SIDEWALK)	SQFT	500	7.32	8.30
20	017003	REPAIR CATCH BASIN (CURB INLET) (CRS 300)	EA	1	2,500.00	2,800.00
21	840519	THERMOPLASTIC CROSSWALK AND PAVEMENT MARKING	SQFT	3,540	4.95	3.60
22	840656	PAINT TRAFFIC STRIPE (2-COAT)	LF	35,900	0.27	0.30
23	850111	PAVEMENT MARKER (RETROREFLECTIVE)	EA	1,340	3.30	3.60
24	860811	DETECTOR LOOP	EA	26	163.00	200.00
25	152440	ADJUST STORM DRAIN MAINHOLE TO GRADE	EA	17	575.00	600.00
26	566011	ROADSIDE SIGN - ONE POST	EA	39	300.00	250.00
27	150710	REMOVE TRAFFIC STRIPE	LF	1,000	1.45	2.00
28	000003	REMOVE AND SALVAGE SIGN AND POST	EA	10	50.00	83.50
29	000003	REPLACE EXISTING R1-1 ON EXISTING POST	EA	21	176.00	128.00
30	000003	FURNISH AND INSTALL STREET NAME SIGN (CRS 1220)	EA	12	405.00	222.00
		<b>SUBTOTAL (Base Bid)</b>				<b>1,999,631.00</b>
		<b>ITEMS 1-30</b>				<b>2,035,388.00</b>

**Riverside County Transportation Department  
Summary of Bids**

**PROJECT: Horsethief Canyon Road and Knabe Road Resurfacing Project  
in the Temescal Valley area of Riverside County**

Advertised: June 19, 2012 (Agenda Item: 3.47)  
Addenda: 1(7/10/12), 2(7/12/12)  
Bids Open: 2 pm Date: Wednesday, July 18, 2012

**PROJECT NO. C2-0137 & C0-0523**

ALTERNATE BID (EVMWD & LEE LAKE WATER)		4		5				
ITEM NO.	ITEM CODE	CONTRACT ITEM	UNITS	QUANTITY	BID UNIT PRICE	BID ESTIMATE	BID UNIT PRICE	BID ESTIMATE
31	152475	ADJUST SEWER MH/CLEAN OUT TO GRADE - KNABE	EA	18	590.00	10,620.00	600.00	10,800.00
32	152475	ADJUST SEWER MH/CLEAN OUT TO GRADE - HORSETHIEF	EA	9	590.00	5,310.00	600.00	5,400.00
		SUBTOTAL (Alternate Bid)				15,930.00		16,200.00
		ITEM 31-32						

Silvia Construction, Inc.  
Rancho Cucamonga, CA 91730

Sully-Miller Contracting Company  
Brea, CA 92821

<b>PROJECT TOTAL</b>						2,015,561.00		2,051,588.00
ITEMS 1-32								

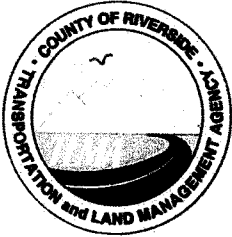

**COUNTY OF RIVERSIDE  
TRANSPORTATION AND  
LAND MANAGEMENT AGENCY**

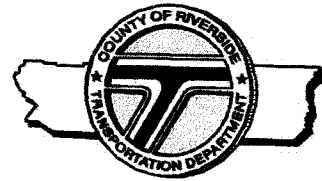

*Juan C. Perez, P.E., T.E.*  
Director of Transportation

**Transportation Department**

**ADDENDUM NUMBER 1**

**Dated July 10, 2012**

**to the  
Specifications and Contract Documents  
for the construction of**

**Horsethief Canyon Road and Knabe Road  
Resurfacing Project in  
The Temescal Valley Area of Riverside County**

**Project No. C2-0137 & C0-0523**

**Bids Due: (REVISED)  
Wednesday, July 18, 2012; 2:00 PM  
14<sup>th</sup> Street Transportation Annex  
3525 14<sup>th</sup> Street; Riverside, CA 92501  
(951) 955-6780**

This Addendum is issued pursuant to the Instructions to Bidders, Item No. 8, of the Contract Documents for the reference project. This Addendum is issued as a supplement to the specification and special provisions for the referenced project. The revisions to the specifications shall become a part of the Contract Documents, and each bidder shall acknowledge receipt thereof on the Contractor's Proposal. Bidders are directed to sign this addendum as acknowledged, and attach the signed addendum to the contractor's submitted proposal.

Note: During the advertisement period of this project, this document and attachments (if any) are available upon request at the office of the Transportation Department, and are available as a free download at the Transportation Department's website:

[http://www.rctlma.org/trans/con\\_bid\\_advertisements.html](http://www.rctlma.org/trans/con_bid_advertisements.html)

**MODIFICATIONS / CLARIFICATIONS TO SPECIAL PROVISIONS:**

**Item 1:** The new designated date and time for the receipt and opening of bids is revised as follows:

**Wednesday, July 18, 2012; 2:00 PM  
14<sup>th</sup> Street Transportation Annex  
3525 14<sup>th</sup> Street; Riverside, CA 92501  
(951) 955-6780**

Prepared by: \_\_\_\_\_

Joel Jimenez, PE; Senior Civil Engineer; Contracts/Bidding Unit

Acknowledged: \_\_\_\_\_ Date: \_\_\_\_\_

(Contractor)

JRJ:jrj



# COUNTY OF RIVERSIDE TRANSPORTATION AND LAND MANAGEMENT AGENCY



Juan C. Perez, P.E., T.E.  
Director of Transportation

## Transportation Department

### ADDENDUM NUMBER 2

Dated July 12, 2012

to the  
Specifications and Contract Documents  
for the construction of

Horsethief Canyon Road and Knabe Road  
Resurfacing Project in  
The Temescal Valley Area of Riverside County

Project No. C2-0137 & C0-0523

**Bids Due: Wednesday, July 18, 2012; 2:00 PM**  
14<sup>th</sup> Street Transportation Annex  
3525 14<sup>th</sup> Street; Riverside, CA 92501  
(951) 955-6780

This Addendum is issued pursuant to the Instructions to Bidders, Item No. 8, of the Contract Documents for the reference project. This Addendum is issued as a supplement to the specification and special provisions for the referenced project. The revisions to the specifications shall become a part of the Contract Documents, and each bidder shall acknowledge receipt thereof on the Contractor's Proposal. Bidders are directed to sign this addendum as acknowledged, and attach the signed addendum to the contractor's submitted proposal.

Note: During the advertisement period of this project, this document and attachments (if any) are available upon request at the office of the Transportation Department, and are available as a free download at the Transportation Department's website:

[http://www.rctlma.org/trans/con\\_bid\\_advertisements.html](http://www.rctlma.org/trans/con_bid_advertisements.html)

### MODIFICATIONS / CLARIFICATIONS TO SPECIAL PROVISIONS:

#### Item 1: Revised Proposal.

Refer to "Proposal" pages B3. Proposal (page B3) is deleted and replaced with revised "Proposal" attached herewith as **Attachment "A"** (two pages). The following changes have been made to the Proposal Schedule:

a. The quantities of following bid items have been revised:

- Item 21, "THERMOPLASTIC CROSSWALK AND PAVEMENT MARKING"
- Item 22, "PAINT TRAFFIC STRIPE (2-COAT)"
- Item 23, "PAVEMENT MARKER (RETROFLECTIVE)"

b. The following bid items have been added to the bid proposal:

- Item 26, "ROADSIDE SIGN - ONE POST"
- Item 27, "REMOVE TRAFFIC STRIPE"
- Item 28, "REMOVE AND SALVAGE SIGN AND POST"
- Item 29, "REPLACE EXISTING R1-1 SIGN ON EXISTING POST"
- Item 30, "FURNISH AND INSTALL STREET NAME SIGN (CRS 1220)"

c. Alternate Bid has been revised. Two bid items from previous proposal have been deleted and remainder two items have been renumbered. See revised proposal.

**See Attachment "A", Revised Proposal**

**Item 2: Wedge Plane/Cold Plane Asphalt Concrete Pavement.**

Refer to payment clause for Section "Wedge Plane/Cold Plane Asphalt Concrete Pavement " on page 67 of the Special Provisions. Pay clause revised to read as follow:

"The contract unit bid price paid per Linear Foot for Wedge Plane/Cold Plane Asphalt Concrete Pavement shall include full compensation for providing all labor, tools, equipment and disposing of the grindings, and no additional compensation will be allowed therefor."

**Item 3: Cold-in-Place Recycling.**

Refer to section "Cold-in-Place Recycling" and subsection entitled "Emulsified Recycling Agent" on page 82. Delete this subsection and replace with the following:

**Emulsified Recycling Agent**

The Emulsified Recycling Agent shall be a polymer modified rejuvenating emulsion with a latex polymer, rejuvenating agent, and paving asphalt and shall conform to the following requirements:



**Table A. Recycling Agent**

<b>Emulsified Recycling Agent Requirements</b>			
	<b>Test Method</b>	<b>Requirement</b>	
		<b>Minimum</b>	<b>Maximum</b>
<b>Tests on emulsion:</b>			
Sieve test, % of weight sample	AASHTO T59 <sup>a</sup>	---	0.1
Residue by distillation, %	AASHTO T59 <sup>a</sup>	60	--
Rap Coating Test (min)	AASHTO T59 <sup>a</sup>	Good	
<b>Tests on residue by distillation:</b>			
Penetration at 25°C, 100 g / 5 sec (TV) (min)	AASHTO T49 <sup>b,d,e</sup>	TV +/- 25 percent <sup>c</sup>	
Absolute Viscosity at 60°C, Pascal second (x10 <sup>-1</sup> ) (TV) <sup>d</sup>	AASHTO T2171	Report Only	

Notes:

- <sup>a</sup> Modify AASHTO T 59 - distillation temperature of 350°F with a 20 minute hold.
- <sup>b</sup> CIR mixture emulsified recycling agent and water application rates to be determined using jobsite RAP in CIR mix design and submitted in job mix formula.
- <sup>c</sup> Target value (TV) is determined for emulsified recycling agent chosen for use and submitted in job mix formula.
- <sup>d</sup> Sieve residue from distillation on No. 20 sieve before determining viscosity.
- <sup>e</sup> Modified procedure may be used: The sample shall be removed from the bath, shaken gently to remove free water from the surface of the specimen, tested in a dry surface state, and then immediately replaced in the water bath in less than 60 seconds. Repeat for determination.

The latex polymer shall conform to the requirements in Table B:

**Table B. Latex Polymer**

<b>Latex Polymer Requirements</b>			
	<b>Test Method</b>	<b>Requirement</b>	
		<b>Minimum</b>	<b>Maximum</b>
<b>Test on Latex Polymer:</b>			
Specific Gravity	ASTM D1475	1.08	---
Tensile strength, die C dumbbell, psi	ASTM D412 <sup>(1)</sup>	500	---
Swelling in rejuvenating agent, %; 48 hours exposure @ 104°F	ASTM D471 <sup>(2)</sup> Modified	---	40% intact film

<sup>(1)</sup> Tensile Strength Determination: Samples for testing for tensile strength in accordance with ASTM D412 shall be cut using a die dumbbell at a crosshead speed of 20 in/min.

<sup>(2)</sup> Latex Testing: Suitable substrate for film formation shall be polyethylene boards, silicone rubber sheeting, glass, or any substrate which produces a cured film of uniform cross-section. Polymer film shall be prepared from latex as follows:

Resistance to Swelling: Polymer films shall be formed by using a 50 mil drawdown bar and drawing down 50 mils of the latex on polyethylene boards. Films shall be cured for 14 days at 75°F and 50% humidity. Samples for resistance to swelling in rejuvenating agent shall be 1" by 2" rectangles cut from the cured film. Cut at least 3 specimens for each sample to be tested for swelling. Fill 3- 8 oz ointment tins with at least a ½" deep of rejuvenating agent. Swelling samples shall be weighed and then placed in the ointment tins on top of the rejuvenating agent. Then, add at least another ½" deep of rejuvenating agent over each of the latex samples. The ointment tins shall be covered and placed in an oven at 104°F for the specified 48 hours +/- 15 minutes. The ointment tins are allowed to cool to 75°F and then the latex films are removed from the tins. Unabsorbed rejuvenating agent is removed from the intact latex film by scraping with a rubber policeman and blotting with paper towels. If the latex film does not remain intact during removal from the tins or while removing the unabsorbed rejuvenating agent the sample shall be rejected. After the rejuvenating agent is removed from the samples they are then weighed. Percent swelling is reported as weight increase of the polymer film; report mass increase as a percent by weight of the original latex film mass upon exposure of films to the recycling agent.

The rejuvenating agent shall meet the requirements in Table C:

**Table C. Rejuvenating Agent**

<b>Rejuvenating Agent Requirements</b>			
	<b>Test Method</b>	<b>Requirement</b>	
		<b>Minimum</b>	<b>Maximum</b>
<b>Test on Rejuvenating Agent:</b>			
Viscosity, 140F, CST	ASTM D2170	50-175	
Flash Point, F, COC	ASTM D92	380	---
Saturate, % by wt.	ASTM D2006-70	---	30
Asphaltenes	ASTM D2006-70	---	1.0
<b>Test on Residue:</b>			
Weight Change, %	ASTM D2872	---	6.5
Viscosity Ratio (RTFO/Original)	ASTM D2170	---	3.0

Paving asphalt used to make the emulsified recycling agent shall conform to the requirements of the Performance Graded (PG) Asphalt Binder Specified in AASHTO M320. The Certificate of Compliance shall indicate the target value for penetration, and bending beam results."

Also refer to **page 84** and delete the reference of "Table B" from the text and title on table and replace with "**Table D**".

## SUMMARY

### **HORSETHIEF CANYON ROAD**

Domestic Water Valves Lowered and raised by Contractor

Reclaimed Water Valves Removed by Contractor, new valve covers and slip can installed by Owner to be raised to finish surface by Contractor

Sewer Manholes Contractor to provide cost to lower and raise

Storm Drain Manholes Lowered and raised by Contractor

All others Protect in place

### **KNABE ROAD**

Domestic Water Valves Lowered and raised by Contractor

Reclaimed Water Valves None

Sewer Manholes Contractor to provide cost to lower and raise

Storm Drain Manholes Lowered and raised by Contractor

All others Protect in place

Full compensation for the removal of the existing reclaimed water concrete encased frames and covers shall be in accordance with the second paragraph of the Payment clause of the subsection entitled "Adjustment to Grade for Obstructions" of the Special Provision entitled "Obstructions" (page 55 of the contract documents.)

### **See Attachment "B", Valve Well and Riser Detail drawing**

**Item 5: Roadside Sign (Install)**

The following Special Provision is added to the Contract Documents and made part hereof:

**ROADSIDE SIGN (INSTALL):**

Roadside signs (install) shall conform to the provisions in Section 56-2 "Roadside Signs" of the Standard Specifications and these special provisions.

The Contractor shall furnish and install roadside signs, in accordance with Standard Plans RS-2, at the locations shown on the plans or as directed by the Engineer.

Roadside signs with steel posts shall be installed at the location shown on the construction plans or where directed by the Engineer.

Roadside signs furnished by the Contractor shall be of the standard size specified in the State of California Department of Transportation Sign Specification Sheets, unless otherwise indicated on the construction plans.

Sheeting shall be guaranteed against defects for a period of ten years from the date of fabrication.

The base metal shall be new aluminum, 0.08 gauge, of alloys 6061-T6 or 5052-H38 conforming to the requirements of ASTM Designation: B209.

Any reflective sheeting supplied, as a part of this contract, whether as a legend or background, shall be FHWA FP-85 Type IIA or AASHTO M268 Type III.

Reflective sheeting shall be applied to the sign by a method approved by the manufacturer of the sheeting and shall produce a durable bond equal to or greater than the strength of the reflective sheeting. No air pockets or bubbles shall exist between the sheeting and aluminum backing.

The reflective material and screening inks or overlay film shall be graffiti proof. The graffiti proofing method shall be supplied by and/or approved by the sheeting manufacturer. Neither the color nor the reflective intensity of the finished sign shall be significantly diminished by the use of graffiti remover when used in a manner approved by the Transportation Department in conjunction with the sheeting manufacturer. Any sign graffiti with the use of over-the-counter spray paint or marking pens, which fail to be restored, shall be replaced by the sign sheeting manufacturer.

All letters and numerals shall be in accordance with the "Standard Alphabet of Highway Signs" as used by the State of California, Department of Transportation.

All signs shall be installed using hex head bolts, washers, nuts and jam nuts in accordance with Standard Plans RS2 or as directed by the Engineer.

***Method of Payment***

The contract price paid per each Roadside Sign shall include full compensation for furnishing all labor, materials, tools, equipment, incidentals, and for doing all the work involved including all necessary concrete, excavation and backfill as specified in the Standard Specification and these Special Provisions and no additional compensation will be allowed therefor.

**Item 6: Remove and Salvage Sign and Post.**

The following Special Provision is added to the Contract Documents and made part hereof:

**REMOVE AND SALVAGE SIGN AND POST:**

Existing roadside signs and post, shall be removed, and salvaged as shown on the plans.

Existing roadside signs at locations shown on the plans to be removed shall not be

removed until replacement signs have been installed or until the existing signs are no longer required for direction of public traffic, unless otherwise directed by the Engineer.

County owned removed and salvaged signs shall be delivered to the nearest County Maintenance Yard or as directed by the Engineer. The County Maintenance Yard is located at the following address:

19355 Ontario Avenue  
Corona, CA 92881-4258  
(951) 737-2310

***Method of Payment***

The contract price paid per each for remove and salvage sign and post shall include full compensation for furnishing all labor, materials, tools, equipment, incidentals and for doing all the work including protecting, storing, transporting and delivering Road Sign as specified in the these Special Provisions and no additional compensation will be allowed therefor.

**Item 7: Remove Traffic Stripe.**

The following Special Provision is added to the Contract Documents and made part hereof:

**REMOVE TRAFFIC STRIPE**

Where blast cleaning/grinding is used for the removal of painted/thermoplastic traffic stripes or for removal of objectionable material, and such removal operation is being performed within 10 feet of a lane occupied by public traffic, the residue including dust shall be removed immediately after contact between the sand and the surface being treated. Such removal shall be by wet abrasive blasting, hydro-blasting or vacuum blasting, and shall comply with AQMD regulations.

Blast cleaning/grinding for removal of traffic stripes shall be feathered out to irregular and varying widths.

After removal of traffic stripes, a fog seal coat shall be applied in conformance with the provisions in Section 37, "Bituminous Seals" of the Standard Specifications and the following:

If removal of existing striping is performed more than 24 hours prior to final striping, the Contractor shall place reflective temporary striping tape throughout the limits of sandblasting, to provide channelization of traffic, for all lanes of travel.

Temporary striping tape shall be removed subsequent to final striping.

Nothing in these Special Provisions shall relieve the Contractor from his responsibilities as provided in Section 7-1.09, "Public Safety" of the Standard Specifications.

***Method of Payment***

The contract price paid per linear foot for Remove Traffic Stripe shall include full compensation for furnishing all labor, materials, tools, equipment, incidentals and no additional compensation will be allowed therefor.

**Item 8: Replace Existing R1-1 sign on Existing Post.**

The following Special Provision is added to the Contract Documents and made part hereof:

**REPLACE EXISTING R1-1 SIGN ON EXISTING POST:**

Contractor shall remove and replace existing R1-1 signs with new R1-1 signs on existing post where shown on the plan in conformance with Section 56-2 "Roadside Signs" of the Standard Specifications and these special provisions.

The removed sign shall be salvaged at the nearest County Yard and/or as directed by the Engineer. The County Maintenance Yard is located at the following address:

19355 Ontario Avenue  
Corona, CA 92881-4258  
(951) 737-2310

***Method of Payment***

The contract price paid per each for replace existing R1-1 Sign on existing post shall include full compensation for furnishing all labor, materials, tools, equipment, incidentals and for doing all the work including protecting, storing, transporting and delivering Sign as specified in the these Special Provisions and no additional compensation will be allowed therefor.

**Item 9: Furnish and Install Street Name Sign.**

The following Special Provision is added to the Contract Documents and made part hereof:

**FURNISH AND INSTALL STREET NAME SIGN:**

Street name signs shall furnish and install in conform with the County Road Improvement Standard, Standard Specifications and these Special Provisions and as directed by the Engineer.

***Method of Payment***

The contract price paid per each for furnish and install street name sign shall include full compensation for furnishing all labor, materials, tools, equipment, incidentals and for doing all the work including excavation and backfill, and installation as specified in the Standard Specification and these Special Provisions and no additional compensation will be allowed therefor.

**See Attachment "C", Street Name Sign Standard drawing**

This addendum has been prepared under the direction of the following registered Civil Engineer:

**Recommended by:**

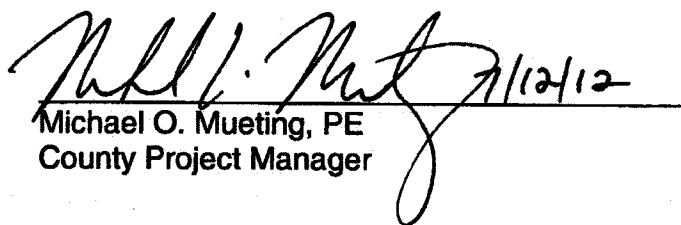
  
Michael O. Mueting, PE  
County Project Manager



**Concurrence:**

 7/12/12  
Khalid Nasim, PE  
Engineering Division Manager

**Acknowledged:** \_\_\_\_\_ **Date:** \_\_\_\_\_  
(Contractor)

JRJ:jrj:sb

## CONTRACTOR'S PROPOSAL

TO: COUNTY OF RIVERSIDE

DATE: July 10, 2012

hereafter called "County":

BIDDER: All American Asphalt  
(hereafter called "Contractor")

THE UNDERSIGNED, Contractor, having carefully examined the site and the Contract Documents for the construction of Horsethief Canyon Road and Knabe Road Resurfacing Projects in the Temescal Valley area of Riverside County, Project No. C2-0137 and C0-0523 hereby proposes to construct the work in accordance with the Contract Documents, including Addenda Nos. #1, #2 for the amount stated in this Proposal.

By submitting this Proposal, Contractor agrees with County:

1. That unless withdrawn in person by Contractor or some person authorized in writing by Contractor not by telephone or telegram before the time specified in the Notice Inviting Bids for the public opening of bids, this Proposal constitutes an irrevocable offer for 90 calendar days after that date.
2. County has the right to reject any or all Proposals and to waive any irregularities or informalities contained in a Proposal.
3. To execute the Agreement and deliver the Faithful Performance Bond, Payment Bond and Insurance Certificate with endorsements, which comply with the requirements set forth in the Instructions to Bidders and General Conditions, within ten (10) working days of the date of the Notice of Acceptance of Proposal and Intent to Award as issued by the County of Riverside.
4. That the contract shall be awarded upon a resolution or minute order to that effect duly adopted by the governing body of County; and that execution of the Contract Documents shall constitute a written memorial thereof.
5. To submit to County such information as County may require to determine whether a particular Proposal is the lowest responsible bid submitted.



6. That the accompanying certified or cashier's check or Bid Bond is in an amount not less than 10% of the total bid submitted and constitutes a guarantee that if awarded the contract, Contractor will execute the Agreement and deliver the required bonds within ten (10) days after notice of award. If Contractor fails to execute and deliver said documents, the check or bond is to be charged with the costs of the resultant damages to County, including but not limited to publication costs, the difference in money between the amount bid and the amount in excess of the bid which it costs County to do or cause to be done the work involved, lease and rental costs, additional salaries and overhead, increased interest and costs of funding the project, attorney expense, additional engineering and architectural expense and cost of maintaining or constructing alternate facilities occasioned by the failure to execute and deliver said documents.
  
7. By signing this proposal the Contractor certifies that the representations made therein are made under penalty of perjury.

**Horsethief Canyon Road and Knabe Road  
Resurfacing Projects In  
The Temescal Valley Area of Riverside County  
Project No. C2-0137 & C0-0523**

**PROPOSAL (REVISED)**

**Base Bid**

ITEM No.	ITEM CODE	ITEM	UNIT	ESTIMATED QUANTITY	ITEM PRICE (IN FIGURES)	TOTAL (IN FIGURES)
1	066102	DUST ABATEMENT	LS	1	13815-	13815-
2	074020	WATER POLLUTION CONTROL	LS	1	2500-	2500-
3	120100	TRAFFIC CONTROL SYSTEM	LS	1	12000-	12000-
4	160101	CLEARING AND GRUBBING	LS	1	3100-	3100-
5	170101	DEVELOP WATER SUPPLY	LS	1	1840-	1840-
6	190101	ROADWAY EXCAVATION	CY	570	11.20	6384-
7	011506	WEDGE PLANE ASPHALT CONCRETE	LF	21,000	.83	17430-
8	011506	WEDGE PLANE ASPHALT CONCRETE - MEDIAN	LF	3,000	.83	2490-
9	153103	COLD PLANE ASPHALT CONCRETE PAVEMENT	SQYD	1,000	1.24	1240-
10	000003	COLD IN-PLACE RECYCLING - MIX DESIGN, SAMPLING & TESTING	LS	1	33660-	33660-
11	020256	EMULSIFIED RECYCLING AGENT	TON	560	684-	383040-
12	020255	COLD IN-PLACE RECYCLING	SQYD	88,500	3.31	292935-
13	390130	HOT MIX ASPHALT	TON	610	69-	42090-
14	013901	ASPHALT RUBBER HOT MIX	TON	10,300	71.30	734390-
15	013904	PLACE ASPHALT CONCRETE DIKE (CRS 212) (8")	LF	1,800	7-	12600-
16	017305	MINOR CONCRETE (CURB AND GUTTER) (CRS 201)	LF	500	43-	21500-
17	017306	MINOR CONCRETE (CURB RAMP) (CRS 403)	EA	36	2300-	82800-
18	017317	MINOR CONCRETE (CROSS-GUTTER AND SPANDREL)	SQFT	250	24.60	6150-
19	731521	MINOR CONCRETE (SIDEWALK)	SQFT	500	5.70	2850-
20	017003	REPAIR CATCH BASIN (CURB INLET) (CRS 300)	EA	1	8800-	8800-
21	840519	THERMOPLASTIC CROSSWALK AND PAVEMENT MARKING	SQFT	3,540	3.80	13452-
22	840656	PAINT TRAFFIC STRIPE (2-COAT)	LF	35,900	.22	7898-
23	850111	PAVEMENT MARKER (RETROFLECTIVE)	EA	1,340	4.20	5628-
24	860811	DETECTOR LOOP	EA	26	184-	4784-
25	152440	ADJUST STORM DRAIN MANHOLE TO GRADE	EA	17	560-	9520-
26	566011	ROADSIDE SIGN - ONE POST	EA	39	231-	9009-
27	150710	REMOVE TRAFFIC STRIPE	LF	1,000	1-	1000-
28	000003	REMOVE AND SALVAGE SIGN AND POST	EA	10	52-	520-
29	000003	REPLACE EXISTING R1-1 ON EXISTING POST	EA	21	102-	2142-
30	000003	FURNISH AND INSTALL STREET NAME SIGN (CRS 1220)	EA	12	372-	4464-

Base Bid Sub  
Items 1-30

One million seven hundred and forty thousand thirty one \$ 1,740,031.00  
"WORDS" dollars and 03/100's

ATTACHMENT "A" TO ADDENDUM 2

**PROPOSAL (REVISED)**

**ALTERNATE BID - (EVMWD & LEE LAKE WATER)**

ITEM No.	ITEM CODE	ITEM	UNIT	ESTIMATED QUANTITY	ITEM PRICE (IN FIGURES)	TOTAL (IN FIGURES)
31	152475	ADJUST SEWER MH/CLEAN OUT TO GRADE - KNABE	EA	18	560	10080
32	152475	ADJUST SEWER MH/CLEAN OUT TO GRADE - HORSETHIEF	EA	9	560	5040

Alt. Bid Sub Total: Fifteen thousand one hundred and twenty dollars \$ 15,120.00  
 Items 31-32 "WORDS" and 00/100's

Project Total: One million seven hundred and fifty five thousand \$ 1,755,511.00  
 Items 1-32 "WORDS" one hundred and fifty one dollars and 00/100's

**BIDDER DATA:**

Name of Bidder All American Asphalt

Type of Organization Corporation

Person(s) Authorized to Sign for Bidder Mark Luer, President

Michael Farnas, Secretary Robert Bradley, Vice President

Address P.O. Box 2229, Corona CA 92878-2229

Phone (951) 736-7600

Contractor's License #2107073, A C-12  
Type & Number

Expiration Date 1-31-2014

8. **DESIGNATION OF SUBCONTRACTORS:** Contractor submits the following complete list of each subcontractor who will perform work or labor or render service in or about the construction in an amount in excess of 1/2 of 1% of the total bid.

<u>ITEM</u>	<u>SUBCONTRACTOR</u>	<u>ADDRESS</u>	<u>LICENSE NO.</u>
20	Wetzel Concrete	Santa Ana	393934
24	Smithson Electric	Orange	614518
21-23 26-30	Superior Pavement Markings	Cypress	776306
10,11,12	Pavement Recycling Systems	Mira Loma	569352

Percent of work to be performed by sub-contractors: 31.82%  
(Note: 50% of the work required to be performed by general contractor)

IN WITNESS WHEREOF Contractor executed this Proposal as of the date set forth on Page 1 of this proposal.

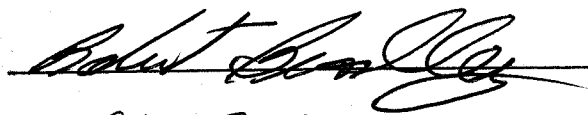

Robert Bradley

TITLE Vice President  
"Contractor"

## Non-Collusion Declaration

To be executed by bidder and submitted with bid. (Public Contract Code Section 7106)

The undersigned declares:

I am the Vice President (Title) of All American Asphalt (Company),  
the party making the foregoing bid.

The bid is not made in the interest of, or on behalf of, any undisclosed person, partnership, company, association, organization, or corporation. The bid is genuine and not collusive or sham. The bidder has not directly or indirectly induced or solicited any other bidder to put in a false or sham bid. The bidder has not directly or indirectly colluded, conspired, connived, or agreed with any bidder or anyone else to put in a sham bid, or that anyone shall refrain from bidding. The bidder has not in any manner, directly or indirectly, sought by agreement, communication, or conference with anyone to fix the bid price of the bidder or any other bidder, or to fix any overhead, profit, or cost element of the bid price, or of that of any other bidder.

All statements contained in the bid are true. The bidder has not, directly or indirectly, submitted his or her bid price of any breakdown thereof, or the contents thereof, or divulged information or data relative thereto, to any corporation, partnership, company, association, organization, bid depository, or to any member or agent thereof to effectuate a collusive or sham bid, and has not paid, and will not pay, any person or entity for such purpose.

Any person executing this declaration on behalf of a bidder that is a corporation, partnership, joint venture, limited liability company, limited liability partnership, or any other entity, hereby represents that he or she has full power to execute, and does execute, this declaration on behalf of the bidder.

I declare under penalty of perjury under the laws of the State of California that the foregoing is true and correct and that this declaration is executed on

July (Month) 10th (Day) of 2012 (Year),

at Corona (City), California.

Signature of Declarant:



Printed name of Declarant: Robert Bradley

Name of Bidder (Company): All American Asphalt

Title or Office: Vice President

Note: Notarization of signature required.  
 Check box if attachment is included.

**CALIFORNIA ALL-PURPOSE ACKNOWLEDGMENT**

State of California

County of Riverside

On July 10, 2012 before me, Debbie Matsen, Notary Public  
Date Here Insert name and Title of the Officer

personally appeared Robert Bradley  
Name(s) of Signer(s)

who proved to me on the basis of satisfactory evidence to be the person(s) whose name(s) is/are subscribed to the within instrument and acknowledged to me that he/she/they executed the same in his/her/their authorized capacity(ies), and that by his/her/their signature(s) on the instrument the person(s), or the entity upon behalf of which the person(s) acted, executed the instrument.

I certify under PENALTY OF PERJURY under the laws of the State of California that the forgoing paragraph is true and correct.

WITNESS my hand and official seal.

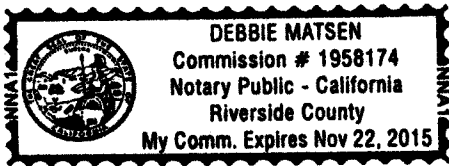

Place Notary Seal Above

Signature Debbie Matsen  
Signature of Notary Public

**OPTIONAL**

Though the information below is not required by law, it may prove valuable to person relying on the document and could prevent fraudulent removal and reattachment of this form to another document.

**Description of Attached Document**

Title or Type of Document Non-Collusion Declaration, County of Riverside

Document Date: July 10, 2012 Number of Pages: 1 Page

Signer(s) Other Than Named Above: None.

**Capacity(ies) Claimed by Signer(s)**

Signer's Name: Robert Bradley

- Individual
- Corporate Officer — Title(s): Vice President
- Partner —  Limited  General
- Attorney in Fact
- Trustee
- Other: \_\_\_\_\_

Signer is Representing: \_\_\_\_\_

All American Asphalt

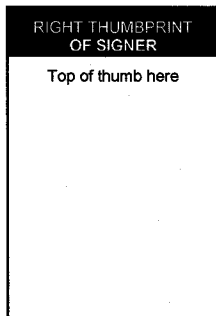

Signer's Name: \_\_\_\_\_

- Individual
- Corporate Officer — Title(s): \_\_\_\_\_
- Partner —  Limited  General
- Attorney in Fact
- Trustee
- Other: \_\_\_\_\_

Signer is Representing: \_\_\_\_\_

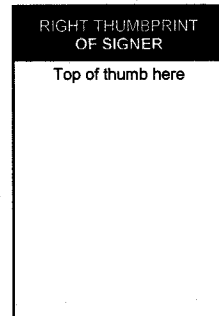

**Iran Contracting Act**  
**(Public Contract Code sections 2200-2208)**

Prior to bidding on, submitting a proposal or executing a contract or renewal for a County of Riverside contract for goods or services of \$1,000,000 or more, a Contractor must either:

- a) Certify it is not on the current list of persons engaged in investment activities in Iran created by the California Department of General Services ("DGS") pursuant to Public Contract Code section 2203(b) and is not a financial institution extending twenty million dollars (\$20,000,000) or more in credit to another person, for 45 days or more, if that other person will use the credit to provide goods or services in the energy sector in Iran and is identified on the current list of persons engaged in investment activities in Iran created by DGS; or
- b) Demonstrate it has been exempted from the certification requirement for that solicitation or contract pursuant to Public Contract Code section 2203(c) or (d).

To comply with this requirement, please insert your Contractor or financial institution name and Federal ID Number (if available) and complete one of the options below. Please note: California law establishes penalties for providing false certifications, including civil penalties equal to the greater of \$250,000 or twice the amount of the contract for which the false certification was made; contract termination; and three-year ineligibility to bid on contracts. (Public Contract Code section 2205.)

**Option #1 – Certification**

I, the official named below, certify I am duly authorized to execute this certification on behalf of the vendor/financial institution identified below, and the vendor/financial institution identified below is **not** on the current list of persons engaged in investment activities in Iran created by DGS and is not a financial institution extending twenty million dollars (\$20,000,000) or more in credit to another person/vendor, for 45 days or more, if that other person/vendor will use the credit to provide goods or services in the energy sector in Iran and is identified on the current list of persons engaged in investment activities in Iran created by DGS.

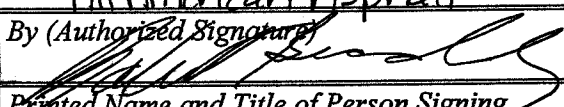
<i>Contractor Name/Financial Institution (Printed)</i> All American Asphalt		<i>Federal ID Number (or n/a)</i> 95-2595043
<i>By (Authorized Signature)</i> 		
<i>Printed Name and Title of Person Signing</i> Robert Bradley, Vice President		
<i>Date Executed</i> July 10, 2012	<i>Executed in</i> Corona, California	

**Option #2 – Exemption**

Pursuant to Public Contract Code sections 2203(c) and (d), a public entity may permit a Contractor/financial institution engaged in investment activities in Iran, on a case-by-case basis, to be eligible for, or to bid on, submit a proposal for, or enters into or renews, a contract for goods and services.

If you have obtained an exemption from the certification requirement under the Iran Contracting Act, please fill out the information below, and attach documentation demonstrating the exemption approval.

<i>Contractor Name/Financial Institution (Printed)</i>		<i>Federal ID Number (or n/a)</i>
<i>By (Authorized Signature)</i>		
<i>Printed Name and Title of Person Signing</i>		
<i>Date Executed</i>	<i>Executed in</i>	



# ALL AMERICAN ASPHALT ALL AMERICAN AGGREGATES

---

---

P.O. BOX 2229, CORONA, CA 92878-2229  
STATE CONTRACTORS LICENSE #267073-A

## CORPORATE RESOLUTION

Resolved, that this Corporation, All American Asphalt, on June 1, 2012 authorizes Robert Bradley to execute contracts and agreements on behalf of the Company in the capacity of Vice President.

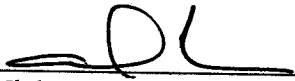
  
\_\_\_\_\_  
Michael Farkas  
Secretary





**COUNTY OF RIVERSIDE**  
**Transportation and Land Management Agency**  
**TRANSPORTATION DEPARTMENT**

**Facsimile Transmittal**

**July 10, 2012**

**TO: Plan Holders and Plan Rooms**

**FROM: Joel Jimenez**  
**Contracts and Utilities Unit**  
**Voice: (951) 955-1537 Fax: (951) 955-3164**  
**Email: [jrjimenez@rctlma.org](mailto:jrjimenez@rctlma.org)**  
**[www.tlma.co.riverside.ca.us/tran](http://www.tlma.co.riverside.ca.us/tran)**

**RE: Transmittal of Addendum no. 1**  
**Horsethief Canyon Road and Knabe Road Resurfacing**  
**Project in the Temescal Valley area of Riverside County**  
**County Project No. C2-0137 and C0-0523**

**Number of Pages transmitted: 2**

---

**Transmitted is addendum no. 1 to the referenced public works project.**

**IMPORTANT: CALL US AT (951)955-6780 TO**  
**ACKNOWLEDGE YOUR RECEIPT OF THE**  
**ADDENDUM. THANK YOU**

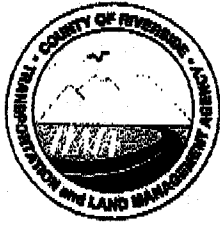

**COUNTY OF RIVERSIDE  
TRANSPORTATION AND  
LAND MANAGEMENT AGENCY**



**Transportation Department**

Juan C. Perez, P.E., T.E.  
Director of Transportation

**ADDENDUM NUMBER 1**

**Dated July 10, 2012**

**to the  
Specifications and Contract Documents  
for the construction of**

**Horsethief Canyon Road and Knabe Road  
Resurfacing Project in  
The Temescal Valley Area of Riverside County**

**Project No. C2-0137 & C0-0523**

**Bids Due: (REVISED)  
Wednesday, July 18, 2012; 2:00 PM  
14<sup>th</sup> Street Transportation Annex  
3525 14<sup>th</sup> Street; Riverside, CA 92501  
(951) 955-6780**

This Addendum is issued pursuant to the Instructions to Bidders, Item No. 8, of the Contract Documents for the reference project. This Addendum is issued as a supplement to the specification and special provisions for the referenced project. The revisions to the specifications shall become a part of the Contract Documents, and each bidder shall acknowledge receipt thereof on the Contractor's Proposal. Bidders are directed to sign this addendum as acknowledged, and attach the signed addendum to the contractor's submitted proposal.

Note: During the advertisement period of this project, this document and attachments (if any) are available upon request at the office of the Transportation Department, and are available as a free download at the Transportation Department's website:

[http://www.rctlma.org/trans/con\\_bid\\_advertisements.html](http://www.rctlma.org/trans/con_bid_advertisements.html)

**MODIFICATIONS / CLARIFICATIONS TO SPECIAL PROVISIONS:**

**Item 1:** The new designated date and time for the receipt and opening of bids is revised as follows:

**Wednesday, July 18, 2012; 2:00 PM  
14<sup>th</sup> Street Transportation Annex  
3525 14<sup>th</sup> Street; Riverside, CA 92501  
(951) 955-6780**

Prepared by: \_\_\_\_\_

Joel Jimenez, PE; Senior Civil Engineer; Contracts/Bidding Unit

Acknowledged: \_\_\_\_\_

Date: July 11, 2012

JRJ:jrj

(Contractor)  
Robert Braden, Vice President  
All American Asphalt

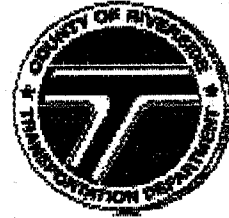

**COUNTY OF RIVERSIDE  
Transportation and Land Management Agency  
TRANSPORTATION DEPARTMENT**

**Facsimile Transmittal**

**July 12, 2012**

**TO: Plan Holders and Plan Rooms**

**FROM: Joel Jimenez  
Contracts and Utilities Unit  
Voice:(951) 955-6780 Fax:(951) 955-3164  
Email: [jrjimenez@rctlma.org](mailto:jrjimenez@rctlma.org)  
[www.tlma.co.riverside.ca.us/tran](http://www.tlma.co.riverside.ca.us/tran)**

**RE: Transmittal of Addendum no. 2  
Horsethief Canyon Road and Knabe Road  
Resurfacing Project in The Temescal Valley  
Area of Riverside County**

**Number of Pages transmitted: 15**

---

**Transmitted is addendum no. 2 to the referenced public works project.**

**IMPORTANT: CALL US AT (951)955-6780 TO  
ACKNOWLEDGE YOUR RECEIPT OF THE  
ADDENDUM. THANK YOU**



**COUNTY OF RIVERSIDE  
TRANSPORTATION AND  
LAND MANAGEMENT AGENCY**



Juan C. Perez, P.E., T.E.  
Director of Transportation

**Transportation Department**

**ADDENDUM NUMBER 2**

**Dated July 12, 2012**

**to the  
Specifications and Contract Documents  
for the construction of**

**Horsethief Canyon Road and Knabe Road  
Resurfacing Project in  
The Temescal Valley Area of Riverside County**

**Project No. C2-0137 & C0-0523**

**Bids Due: Wednesday, July 18, 2012; 2:00 PM**  
14<sup>th</sup> Street Transportation Annex  
3525 14<sup>th</sup> Street, Riverside, CA 92501  
(951) 955-6780

This Addendum is issued pursuant to the Instructions to Bidders, Item No. 8, of the Contract Documents for the reference project. This Addendum is issued as a supplement to the specification and special provisions for the referenced project. The revisions to the specifications shall become a part of the Contract Documents, and each bidder shall acknowledge receipt thereof on the Contractor's Proposal. Bidders are directed to sign this addendum as acknowledged, and attach the signed addendum to the contractor's submitted proposal.

Note: During the advertisement period of this project, this document and attachments (if any) are available upon request at the office of the Transportation Department, and are available as a free download at the Transportation Department's website:

[http://www.rctlma.org/trans/con\\_bid\\_advertisements.html](http://www.rctlma.org/trans/con_bid_advertisements.html)

**MODIFICATIONS / CLARIFICATIONS TO SPECIAL PROVISIONS:**

**Item 1: Revised Proposal.**

Refer to "Proposal" pages B3. Proposal (page B3) is deleted and replaced with revised "Proposal" attached herewith as Attachment "A" (two pages). The following changes have been made to the Proposal Schedule:

**a. The quantities of following bid items have been revised:**

- Item 21, "THERMOPLASTIC CROSSWALK AND PAVEMENT MARKING"
- Item 22, "PAINT TRAFFIC STRIPE (2-COAT)"
- Item 23, "PAVEMENT MARKER (RETROFLECTIVE)"

Addendum No. 2  
Horsehief Canyon Road and Knabe Road Resurfacing Project  
Project No. C2-0137 & C0-0523  
July 12, 2012  
Page 2 of 10

---

b. The following bid items have been added to the bid proposal:

- Item 26, "ROADSIDE SIGN - ONE POST"
- Item 27, "REMOVE TRAFFIC STRIPE"
- Item 28, "REMOVE AND SALVAGE SIGN AND POST"
- Item 29, "REPLACE EXISTING R1-1 SIGN ON EXISTING POST"
- Item 30, "FURNISH AND INSTALL STREET NAME SIGN (CRS 1220)"

c. Alternate Bid has been revised. Two bid items from previous proposal have been deleted and remainder two items have been renumbered. See revised proposal.

**See Attachment "A", Revised Proposal**

**Item 2: Wedge Plane/Cold Plane Asphalt Concrete Pavement.**

Refer to payment clause for Section "Wedge Plane/Cold Plane Asphalt Concrete Pavement" on page 67 of the Special Provisions. Pay clause revised to read as follow:

"The contract unit bid price paid per Linear Foot for Wedge Plane/Cold Plane Asphalt Concrete Pavement shall include full compensation for providing all labor, tools, equipment and disposing of the grindings, and no additional compensation will be allowed therefor."

**Item 3: Cold-in-Place Recycling.**

Refer to section "Cold-in-Place Recycling" and subsection entitled "Emulsified Recycling Agent" on page 82. Delete this subsection and replace with the following:

**Emulsified Recycling Agent**

The Emulsified Recycling Agent shall be a polymer modified rejuvenating emulsion with a latex polymer, rejuvenating agent, and paving asphalt and shall conform to the following requirements:

Addendum No. 2  
 Horsethief Canyon Road and Knabe Road Resurfacing Project  
 Project No. C2-0137 & C0-0523  
 July 12, 2012  
 Page 3 of 10

**Table A. Recycling Agent**

<b>Emulsified Recycling Agent Requirements</b>			
	Test Method	Requirement	
		Minimum	Maximum
<b>Tests on emulsion:</b>			
Sieve test, % of weight sample	AASHTO T59 <sup>a</sup>	---	0.1
Residue by distillation, %	AASHTO T59 <sup>a</sup>	60	--
Rap Coating Test (min)	AASHTO T59 <sup>a</sup>	Good	
<b>Tests on residue by distillation:</b>			
Penetration at 25°C, 100 g / 5 sec (TV) (min)	AASHTO T49 <sup>b,d,e</sup>	TV +/- 25 percent <sup>c</sup>	
Absolute Viscosity at 60°C, Pascal second (x10 <sup>-1</sup> ) (TV) <sup>d</sup>	AASHTO T2171	Report Only	

**Notes:**

- <sup>a</sup> Modify AASHTO T 59 - distillation temperature of 350°F with a 20 minute hold.  
<sup>b</sup> CIR mixture emulsified recycling agent and water application rates to be determined using jobsite RAP in CIR mix design and submitted in job mix formula.  
<sup>c</sup> Target value (TV) is determined for emulsified recycling agent chosen for use and submitted in job mix formula.  
<sup>d</sup> Sieve residue from distillation on No. 20 sieve before determining viscosity.  
<sup>e</sup> Modified procedure may be used: The sample shall be removed from the bath, shaken gently to remove free water from the surface of the specimen, tested in a dry surface state, and then immediately replaced in the water bath in less than 60 seconds. Repeat for determination.

The latex polymer shall conform to the requirements in Table B:

**Table B. Latex Polymer**

<b>Latex Polymer Requirements</b>			
	Test Method	Requirement	
		Minimum	Maximum
<b>Test on Latex Polymer:</b>			
Specific Gravity	ASTM D1475	1.08	---
Tensile strength, die C dumbbell, psi	ASTM D412 <sup>(1)</sup>	500	---
Swelling in rejuvenating agent, %; 48 hours exposure @ 104°F	ASTM D471 <sup>(2)</sup> Modified	---	40% intact film

<sup>(1)</sup> Tensile Strength Determination: Samples for testing for tensile strength in accordance with ASTM D412 shall be cut using a die dumbbell at a crosshead speed of 20 in/min.

<sup>(2)</sup> Latex Testing: Suitable substrate for film formation shall be polyethylene boards, silicone rubber sheeting, glass, or any substrate which produces a cured film of uniform cross-section. Polymer film shall be prepared from latex as follows:

Addendum No. 2  
 Horsethief Canyon Road and Knabe Road Resurfacing Project  
 Project No. C2-0137 & C0-0523  
 July 12, 2012  
 Page 4 of 10

**Resistance to Swelling:** Polymer films shall be formed by using a 50 mil drawdown bar and drawing down 50 mils of the latex on polyethylene boards. Films shall be cured for 14 days at 75°F and 50% humidity. Samples for resistance to swelling in rejuvenating agent shall be 1" by 2" rectangles cut from the cured film. Cut at least 3 specimens for each sample to be tested for swelling. Fill 3- 8 oz ointment tins with at least a 1/8" deep of rejuvenating agent. Swelling samples shall be weighed and then placed in the ointment tins on top of the rejuvenating agent. Then, add at least another 1/2" deep of rejuvenating agent over each of the latex samples. The ointment tins shall be covered and placed in an oven at 104°F for the specified 48 hours +/- 15 minutes. The ointment tins are allowed to cool to 75°F and then the latex films are removed from the tins. Unabsorbed rejuvenating agent is removed from the intact latex film by scraping with a rubber policeman and blotting with paper towels. If the latex film does not remain intact during removal from the tins or while removing the unabsorbed rejuvenating agent the sample shall be rejected. After the rejuvenating agent is removed from the samples they are then weighed. Percent swelling is reported as weight increase of the polymer film; report mass increase as a percent by weight of the original latex film mass upon exposure of films to the recycling agent.

The rejuvenating agent shall meet the requirements in Table C:

**Table C. Rejuvenating Agent**

Rejuvenating Agent Requirements			
	Test Method	Requirement	
		Minimum	Maximum
<b>Test on Rejuvenating Agent:</b>			
Viscosity, 140F, CST	ASTM D2170	50-175	
Flash Point, F, COC	ASTM D92	380	---
Saturate, % by wt.	ASTM D2008-70	---	30
Asphaltenes	ASTM D2008-70	---	1.0
<b>Test on Residue:</b>			
Weight Change, %	ASTM D2872	---	6.5
Viscosity Ratio (RTFO/Original)	ASTM D2170	---	3.0

Paving asphalt used to make the emulsified recycling agent shall conform to the requirements of the Performance Graded (PG) Asphalt Binder Specified in AASHTO M320. The Certificate of Compliance shall indicate the target value for penetration, and bending beam results."

Also refer to page 84 and delete the reference of "Table B" from the text and title on table and replace with "Table D".

Addendum No. 2  
Horsethief Canyon Road and Knabe Road Resurfacing Project  
Project No. C2-0137 & C0-0523  
July 12, 2012  
Page 5 of 10

---

**Item 4: Adjust Manhole and Water Valve Cover to Grade.**

Refer to Section "Adjust Manhole and Water Valve Cover to Grade" On page 100 of spec Book. The following is added to the Special Provision and made part thereof:

The following applies to the adjustment of water valve covers, and shall supplement the requirements under "Adjustments to Grade for Obstructions" (Page 54). The following procedures may be modified by mutual agreement among and between the Engineer, the Contractor and the utility owner, with respect to the lowering and final adjustment to grade for both potable and reclaimed water system facilities.

Attention is directed to the existence of a recycled water pipeline system within the project limits on Horsethief Canyon Road, which includes approximately 25 to 30 water valve covers (purple) that are encased in Portland Cement Concrete. The remainder of the valve covers within the limits of work on both Horsethief Canyon Road and Knabe Road are provided with slip cans and adjustment shall be performed by the Contractor as provided under the Special Provision entitled "Obstructions".

The Contractor shall be responsible to remove the existing concrete encased frames and valve covers. The Contractor shall dispose of the removed concreted encased frames as provided elsewhere in these Special Provisions. Valve covers shall be stockpiled for pickup by the utility owner.

The Contractor shall cover the riser pipe to prevent dirt and debris from entering the pipe. The Contractor shall protect the valve and riser from damage.

The owner, after advance notification by the Contractor, will install new slip cans and provide covers for each of the removed concrete encased frames and covers. The Contractor shall provide at least 72 hours notice to the Elsinore Valley Municipal Water District prior to removal of the frames and covers. The EVMWD contact is: Tim Colle (951) 674-3146 X8205.

EVMWD will install the new slip cans and will install the slip cans sufficiently below the pavement to be recycled.

Any existing or new slip cans, for both potable and reclaimed water systems, that cannot be lowered below the grinding plane shall be protected in-place, and the Contractor shall work around those obstacles in a manner that prevents damage to both the utility facilities and to the Contractor's equipment.

The Contractor shall be responsible to adjust all water valves to final grade, as specified in the first paragraph of the subsection entitled "Adjustment to Grade for Obstructions" of the Special Provision entitled "Obstructions", and in accordance with the EVMWD standard drawing labeled "Valve Well and Riser Detail", which is attached, designated as Attachment "B" and made a part hereof.

Full compensation for the removal of the existing reclaimed water concrete encased frames and covers shall be in accordance with the second paragraph of the Payment clause of the subsection entitled "Adjustment to Grade for Obstructions" of the Special Provision entitled "Obstructions" (page 55 of the contract documents.)



Addendum No. 2  
Horse Thief Canyon Road and Knabe Road Resurfacing Project  
Project No. C2-0137 & C0-0523  
July 12, 2012  
Page 6 of 10

---

## SUMMARY

### HORSETHIEF CANYON ROAD

Domestic Water Valves	Lowered and raised by Contractor
Reclaimed Water Valves	Removed by Contractor, new valve covers and slip can installed by Owner to be raised to finish surface by Contractor
Sewer Manholes	Contractor to provide cost to lower and raise
Storm Drain Manholes	Lowered and raised by Contractor
All others	Protect in place

### KNABE ROAD

Domestic Water Valves	Lowered and raised by Contractor
Reclaimed Water Valves	None
Sewer Manholes	Contractor to provide cost to lower and raise
Storm Drain Manholes	Lowered and raised by Contractor
All others	Protect in place

Full compensation for the removal of the existing reclaimed water concrete encased frames and covers shall be in accordance with the second paragraph of the Payment clause of the subsection entitled "Adjustment to Grade for Obstructions" of the Special Provision entitled "Obstructions" (page 55 of the contract documents.)

**See Attachment "B", Valve Well and Riser Detail drawing**

**Item 5: Roadside Sign (Install)**

The following Special Provision is added to the Contract Documents and made part hereof:

**ROADSIDE SIGN (INSTALL):**

Roadside signs (install) shall conform to the provisions in Section 56-2 "Roadside Signs" of the Standard Specifications and these special provisions.

The Contractor shall furnish and install roadside signs, in accordance with Standard Plans RS-2, at the locations shown on the plans or as directed by the Engineer.

Roadside signs with steel posts shall be installed at the location shown on the

Addendum No. 2  
Horsethief Canyon Road and Knabe Road Resurfacing Project  
Project No. C2-0137 & C0-0523  
July 12, 2012  
Page 7 of 10

---

construction plans or where directed by the Engineer.

Roadside signs furnished by the Contractor shall be of the standard size specified in the State of California Department of Transportation Sign Specification Sheets, unless otherwise indicated on the construction plans.

Sheeting shall be guaranteed against defects for a period of ten years from the date of fabrication.

The base metal shall be new aluminum, 0.08 gauge, of alloys 6061-T6 or 5052-H38 conforming to the requirements of ASTM Designation: B209.

Any reflective sheeting supplied, as a part of this contract, whether as a legend or background, shall be FHWA FP-85 Type IIA or AASHTO M268 Type III.

Reflective sheeting shall be applied to the sign by a method approved by the manufacturer of the sheeting and shall produce a durable bond equal to or greater than the strength of the reflective sheeting. No air pockets or bubbles shall exist between the sheeting and aluminum backing.

The reflective material and screening inks or overlay film shall be graffiti proof. The graffiti proofing method shall be supplied by and/or approved by the sheeting manufacturer. Neither the color nor the reflective intensity of the finished sign shall be significantly diminished by the use of graffiti remover when used in a manner approved by the Transportation Department in conjunction with the sheeting manufacturer. Any sign graffiti with the use of over-the-counter spray paint or marking pens, which fail to be restored, shall be replaced by the sign sheeting manufacturer.

All letters and numerals shall be in accordance with the "Standard Alphabet of Highway Signs" as used by the State of California, Department of Transportation.

All signs shall be installed using hex head bolts, washers, nuts and jam nuts in accordance with Standard Plans RS2 or as directed by the Engineer.

#### ***Method of Payment***

The contract price paid per each Roadside Sign shall include full compensation for furnishing all labor, materials, tools, equipment, incidentals, and for doing all the work involved including all necessary concrete, excavation and backfill as specified in the Standard Specification and these Special Provisions and no additional compensation will be allowed therefor.

#### **Item 6: Remove and Salvage Sign and Post.**

The following Special Provision is added to the Contract Documents and made part hereof:

#### **REMOVE AND SALVAGE SIGN AND POST:**

Existing roadside signs and post, shall be removed, and salvaged as shown on the plans.

Addendum No. 2  
Horsethief Canyon Road and Knabe Road Resurfacing Project  
Project No. C2-0137 & C0-0523  
July 12, 2012  
Page 8 of 10

---

Existing roadside signs at locations shown on the plans to be removed shall not be removed until replacement signs have been installed or until the existing signs are no longer required for direction of public traffic, unless otherwise directed by the Engineer.

County owned removed and salvaged signs shall be delivered to the nearest County Maintenance Yard or as directed by the Engineer. The County Maintenance Yard is located at the following address:

19355 Ontario Avenue  
Corona, CA 92881-4258  
(951) 737-2310

***Method of Payment***

The contract price paid per each for remove and salvage sign and post shall include full compensation for furnishing all labor, materials, tools, equipment, incidentals and for doing all the work including protecting, storing, transporting and delivering Road Sign as specified in the these Special Provisions and no additional compensation will be allowed therefor.

**Item 7: Remove Traffic Stripe.**

The following Special Provision is added to the Contract Documents and made part hereof:

**REMOVE TRAFFIC STRIPE**

Where blast cleaning/grinding is used for the removal of painted/thermoplastic traffic stripes or for removal of objectionable material, and such removal operation is being performed within 10 feet of a lane occupied by public traffic, the residue including dust shall be removed immediately after contact between the sand and the surface being treated. Such removal shall be by wet abrasive blasting, hydro-blasting or vacuum blasting, and shall comply with AQMD regulations.

Blast cleaning/grinding for removal of traffic stripes shall be feathered out to irregular and varying widths.

After removal of traffic stripes, a fog seal coat shall be applied in conformance with the provisions in Section 37, "Bituminous Seals" of the Standard Specifications and the following:

If removal of existing striping is performed more than 24 hours prior to final striping, the Contractor shall place reflective temporary striping tape throughout the limits of sandblasting, to provide channelization of traffic, for all lanes of travel.

Temporary striping tape shall be removed subsequent to final striping.

Nothing in these Special Provisions shall relieve the Contractor from his responsibilities as provided in Section 7-1.09, "Public Safety" of the Standard Specifications.

Addendum No. 2  
Horsethief Canyon Road and Knabe Road Resurfacing Project  
Project No. C2-0137 & C0-0523  
July 12, 2012  
Page 9 of 10

---

***Method of Payment***

The contract price paid per linear foot for Remove Traffic Stripe shall include full compensation for furnishing all labor, materials, tools, equipment, incidentals and no additional compensation will be allowed therefor.

**Item 8: Replace Existing R1-1 sign on Existing Post.**

The following Special Provision is added to the Contract Documents and made part hereof:

**REPLACE EXISTING R1-1 SIGN ON EXISTING POST:**

Contractor shall remove and replace existing R1-1 signs with new R1-1 signs on existing post where shown on the plan in conformance with Section 56-2 "Roadside Signs" of the Standard Specifications and these special provisions.

The removed sign shall be salvaged at the nearest County Yard and/or as directed by the Engineer. The County Maintenance Yard is located at the following address:

19355 Ontario Avenue  
Corona, CA 92881-4258  
(951) 737-2310

***Method of Payment***

The contract price paid per each for replace existing R1-1 Sign on existing post shall include full compensation for furnishing all labor, materials, tools, equipment, incidentals and for doing all the work including protecting, storing, transporting and delivering Sign as specified in these Special Provisions and no additional compensation will be allowed therefor.

**Item 9: Furnish and Install Street Name Sign.**

The following Special Provision is added to the Contract Documents and made part hereof:

**FURNISH AND INSTALL STREET NAME SIGN:**

Street name signs shall furnish and install in conform with the County Road Improvement Standard, Standard Specifications and these Special Provisions and as directed by the Engineer.

***Method of Payment***

The contract price paid per each for furnish and install street name sign shall include full compensation for furnishing all labor, materials, tools, equipment, incidentals and for doing all the work including excavation and backfill, and installation as specified in the Standard Specification and these Special Provisions and no additional compensation will be allowed therefor.

**See Attachment "C", Street Name Sign Standard drawing**

Addendum No. 2  
Horse Thief Canyon Road and Knabe Road Resurfacing Project  
Project No. C2-0137 & C0-0523  
July 12, 2012  
Page 10 of 10

This addendum has been prepared under the direction of the following registered Civil Engineer:

**Recommended by:**

*Michael O. Mueting* 7/12/12  
\_\_\_\_\_  
Michael O. Mueting, PE  
County Project Manager



**Concurrence:**

*Khalid Nasim* 7/12/12  
\_\_\_\_\_  
Khalid Nasim, PE  
Engineering Division Manager

**Acknowledged:** *Robert Bradley* Date: July 13, 2012  
JRJ:jrj:sb (Contractor)  
Robert Bradley, Vice President  
All American Asphalt

ATTACHMENT "B" TO ADDENDUM 2

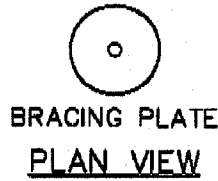

TRAFFIC LID

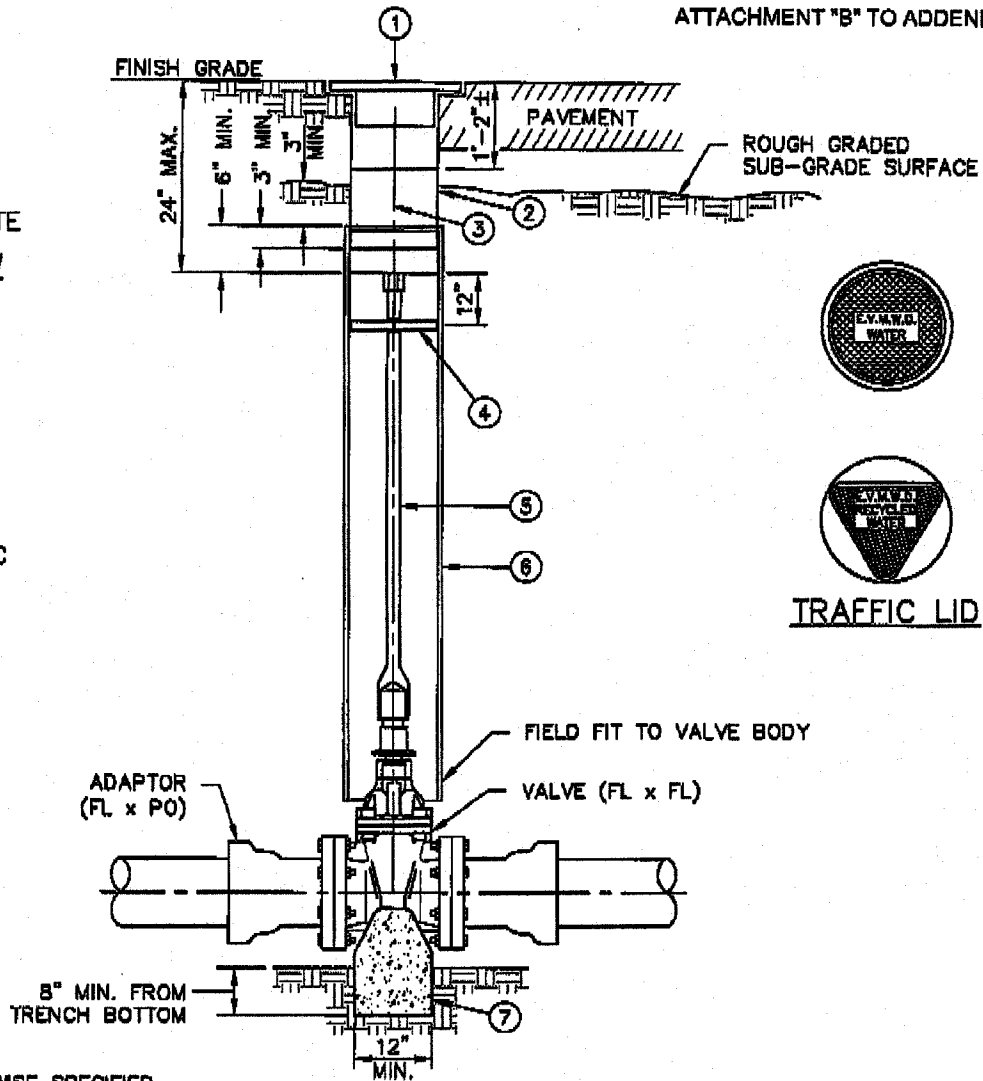

NOTES:  
EXCEPT OTHERWISE SPECIFIED.

1. CONTRACTOR SHALL RAISE SLIP CAN TO GRADE AFTER STREET IS PAVED WHERE PAVING IS PROPOSED.
2. ALL VALVE CANS SHALL BE EXPOSED AT ALL TIMES DURING CONSTRUCTION UNLESS BURIAL FOR GRADING IS AUTHORIZED BY THE INSPECTOR.
3. MATERIALS SHALL BE SELECTED FROM THE ACCEPTED MATERIALS GUIDELINE.
4. WELL CAPS FOR RECYCLED WATER SHALL HAVE A TRIANGULAR SHAPED CAP, BE PURPLE AND MARKED "EVMWD RECYCLED WATER".

ITEM	DESCRIPTION
①	8" VALVE WELL CAP W/ 4" SKIRT PAINTED SAFETY PRECAUTION BLUE ENAMEL & PRIMER, & MARKED "E.V.M.W.D. WATER" ON CAP
②	8" O.D.x18 GA. SPLIT VALVE CAN TOP SECTION, GALVANIZED FOR SLIP CAN, SLIP CAN LENGTH 12", 18" OR 24" AS REQ'D
③	4"x4" REDWOOD POST IF VALVE HAS BLIND FLANGE PER STD. DWG. NO. W-14
④	1/8" + 1/32" SOLID DISC 7-3/4" DIA. AT 5' INTERVALS TACKWELD BRACING PLATE TO STEM
⑤	PROVIDE VALVE STEM EXTENSION WHERE DEPTH TO OPERATOR NUT EXCEEDS 5'
⑥	8" PVC, SDR-35 OR C-900 FOR GATE VALVES 3" AND LARGER, 6" PVC FOR GATE VALVES LESS THAN 3" DIAMETER
⑦	VALVE SUPPORT BLOCK PER STD. DWG. NO. W-15

REVISION	BY	APPR	DATE



Paul S. Carver R.C.E. 31516 DATE

VALVE WELL  
AND RISER DETAIL

STD. DWG. NO.

W-13

ATTACHMENT "C" TO ADDENDUM 2

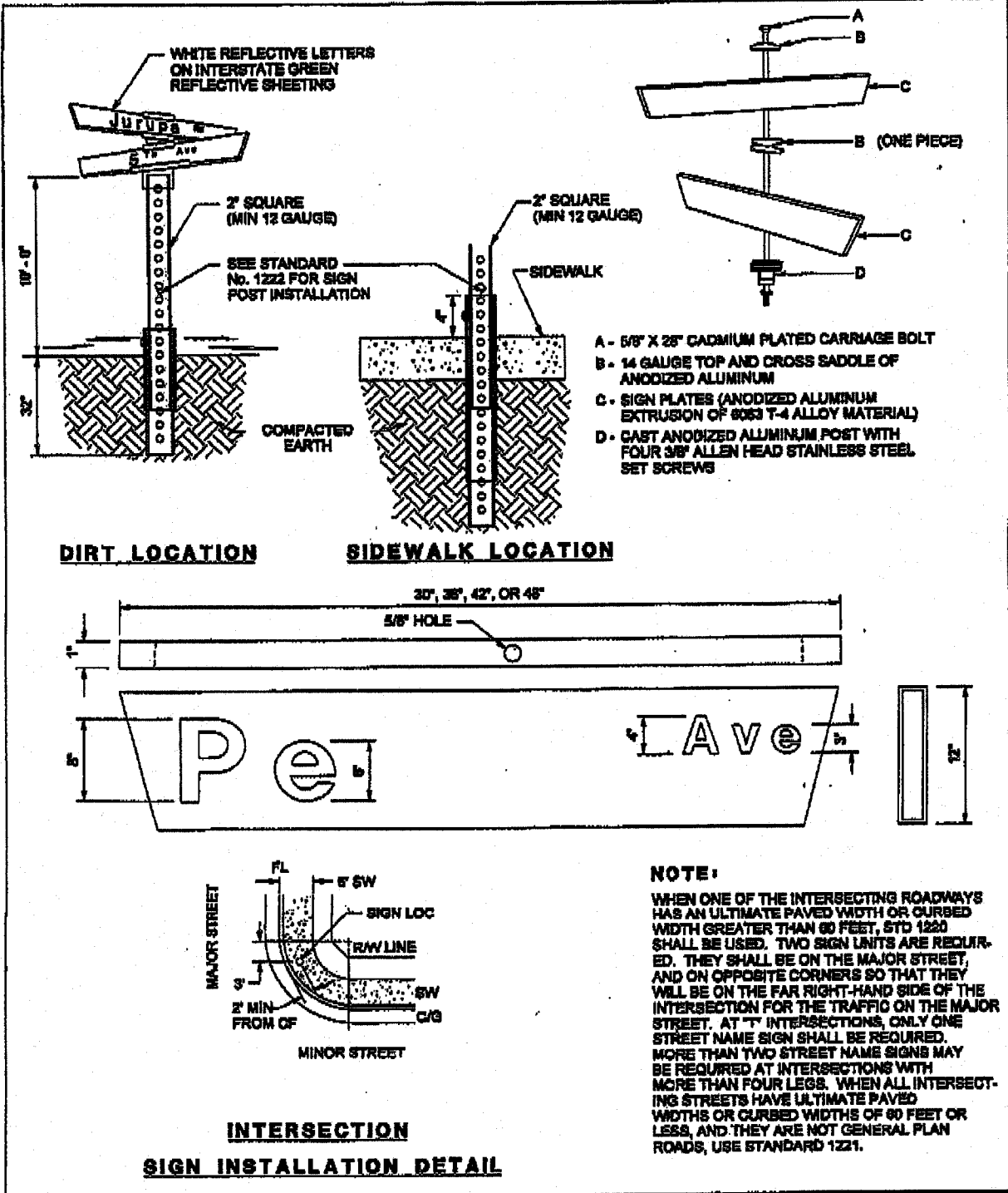

APPROVED BY:			COUNTY OF RIVERSIDE					
DIRECTOR OF TRANSPORTATION JUAN C. PEREZ, RCE 49568			<b>STREET NAME SIGN</b> (CURB TO CURB WIDTH GREATER THAN 60')					
DATE		NO SCALE						
STANDARD No. 1220								
REVISIONS	REV	BY:	APRD	DATE	REV	BY:	APRD	DATE
	1	JK	JP	06-05-10	4			
	2				5			
	3				6			



Monday, July 10, 2012

**PROJECT: Horse Thief Canyon CIR Project – Riverside County  
SUBMITTAL RESPONSE**

The following successful projects have utilized Western Emulsions' recycling emulsion:

**Project :** Cook Street CIR Project  
**Agency:** City of Palm Desert  
**Project Engineer:** Ryan Gaylor P.E. - (760) 348-0611  
[rgaylor@ci.palm-desert.ca.us](mailto:rgaylor@ci.palm-desert.ca.us)  
**Dates:** August 2011

**Project :** Monterey Avenue CIR  
**Agency:** City of Palm Desert / Rancho Mirage  
**Project Engineer:** Ryan Gaylor P.E. - (760) 348-0611  
[rgaylor@ci.palm-desert.ca.us](mailto:rgaylor@ci.palm-desert.ca.us)  
**Dates:** September 2011

**Project :** Angeles Forest highway, et al. CIR  
**Agency:** County of Los Angeles  
**Project Engineer:** Imelda Diaz, P.E. - (626) 458-4923  
[IDIAZ@dpw.lacounty.gov](mailto:IDIAZ@dpw.lacounty.gov)  
**Dates:** August 2011

**Project :** Vasquez Canyon CIR  
**Agency:** County of Los Angeles  
**Project Engineer:** Imelda Diaz, P.E. - (626) 458-4923  
[IDIAZ@dpw.lacounty.gov](mailto:IDIAZ@dpw.lacounty.gov)  
**Dates:** April 2012

**Project :** Crescent Drive, Canon Drive, Beverly Drive, Lomitas Ave.  
**Agency:** Beverly Hills  
**Project Engineer:** Juan Martinez, P.E. - (310) 461-5614  
**Dates:** August 2010

Sincerely,

**Kevin Donnelly, APM**  
Director, Pavement Preservation  
Western Emulsions, Inc.  
3 Monarch Plaza, Suite 210  
Dana Point, CA 92629  
(949) 248-8020 (office)  
(949) 289-3632 (fax)  
(805) 886-0900 (cell)  
[kevin@westernemulsions.com](mailto:kevin@westernemulsions.com)

RM: #351372 CA: #672

ARIZONA

CALIFORNIA

PLANT LOCATIONS





## **Pavement Recycling Systems**

10240 San Sevaine Way, Mira Loma, CA 91752  
PH: (951) 682-1091  
FAX: (951) 682-1094  
[www.pavementrecycling.com](http://www.pavementrecycling.com)

June 25, 2012

Please find the following submittal of CIR projects performed by Pavement Recycling Systems Incorporated:

- 1) Agency- City of Palm Desert  
Project – Cook Street CIR Project  
Project Engineer- Ryan Gaylor P.E. (760) 346-0611  
Construction Dates-August 2011
- 2) Agency- Monterey Ave CIR  
Project –City of Palm Desert / Rancho Mirage  
Project Engineer-Ryan Gaylor P.E. (760) 346-0611  
Construction Dates-September 2011
- 3) Agency- County of Los Angeles  
Project –Angeles Forest Highway et al.  
Project Engineer-Imelda Diaz P.E. (626) 458-4923  
Construction Dates- August 2011
- 4) Agency- County of Los Angeles  
Project – Vasquez Canyon CIR  
Project Engineer-Imelda Diaz, P.E. (626) 458-4923  
Construction Dates- April 2012
- 5) Agency- City of Beverly Hills  
Project –Crescent Drive, Canon Drive, Beverly Drive, Lomitas Ave.  
Project Engineer-Juan Martinez, P.E. (310) 461-5614  
Construction Dates- August 2010

San Diego: 704 Rock Springs Road, Escondido, CA 92025 • Phone: 760.489.6888 • Fax: 760.489.0808  
Palmdale/Lancaster: 46205 N. Division Street, Lancaster, CA 93535 • Phone 661.948.5599 • Fax: 661.948.5588  
Bakersfield: 2280 S. Union, Bakersfield, CA 93307 • Phone: 661.833.2280 • Fax: 661.833.2288  
Fresno: 4692 E. Lincoln Avenue, Fowler, CA 93625 • Phone: 559.627.6788 • Fax: 559.627.9159  
Reno/Carson Valley: 68 Carry Way, Carson NV 89706 • Phone: 775.246.2500 • Fax: 775.246.2501  
CA Lic. #569352    AZ Lic. #183900    NV Lic. #0036228    UT Lic. #6982390-5501    OR Lic. #185556

**Bid Bond**

Recitals:

1. All American Asphalt "Contractor", has submitted his/her Contractor's Proposal to County of Riverside, "County", for the construction of public work for Horsethief Canyon Road and Knabe Road Resurfacing Projects in the Temescal Valley area of Riverside County, Project No. C2-0137 and C0-0523 in accordance with a Notice Inviting Bids from the County.
2. Fidelity and Deposit Company of Maryland a Maryland corporation, hereafter called "Surety", is the surety of this bond.

Agreement:

We, Contractor as Principal and Surety as Surety, jointly and severally agree and state as follows:

1. The amount of the obligation of this bond is 10% of the amount of the Contractor's Proposal, including bid alternates, and inures to the benefit of County.
2. This Bond is exonerated by (1) County rejecting said Proposal or, in the alternate, (2) if said Proposal is accepted, Contractor executes the Agreement and furnishes the Bonds as agreed to in its Proposal, otherwise it remains in full force and effect for the recovery of loss, damage and expense of County resulting from failure of Contractor to act as agreed to in its Proposal. Some types of possible loss, damage and expense are specified in the Contractor's Proposal.
3. Surety, for value received, stipulates and agrees that its obligations hereunder shall in no way be impaired or affected by any extension of time within which County may accept the Proposal and waives notice of any such extension.
4. This Bond is binding on our heirs, executors, administrators, successors and assigns.

Dated: June 27, 2012

Signatures:

Fidelity and Deposit Company of Maryland

All American Asphalt

By: Rebecca Haas-Bates  
Rebecca Haas-Bates, Attorney-in-Fact

Robert Bradley  
Robert Bradley

Title: Attorney in Fact  
"Surety"

Title: Vice President  
"Contractor"

\*\*Please See Attached\*\*

STATE OF \_\_\_\_\_ } ss. SURETY'S ACKNOWLEDGEMENT  
COUNTY OF \_\_\_\_\_

On \_\_\_\_\_ before me, \_\_\_\_\_  
personally appeared, \_\_\_\_\_ known to me, or proved to me on the basis of  
satisfactory evidence, to be the person whose name is subscribed to the within instrument and acknowledged  
to me that he/she executed the same in his/her authorized capacities, and that by his/her signature on the  
instrument the person, or the entity upon behalf of which the person acted, executed the instrument.

WITNESS my hand and official seal.

\_\_\_\_\_  
Signature of Notary Public

Notary Public (Seal)

Note: This Bond must be executed by both Contractor and Surety with corporate seal affixed. All  
signatures must be notarized. (Attach acknowledgements).

**CALIFORNIA ALL-PURPOSE ACKNOWLEDGMENT**

State of California

County of Riverside

On July 10, 2012 before me, Debbie Matsen, Notary Public  
Date Here Insert name and Title of the Officer

personally appeared Robert Bradley  
Name(s) of Signer(s)

who proved to me on the basis of satisfactory evidence to be the person(s) whose name(s) is/are subscribed to the within instrument and acknowledged to me that he/she/they executed the same in his/her/their authorized capacity(ies), and that by his/her/their signature(s) on the instrument the person(s), or the entity upon behalf of which the person(s) acted, executed the instrument.

I certify under PENALTY OF PERJURY under the laws of the State of California that the forgoing paragraph is true and correct.

WITNESS my hand and official seal.

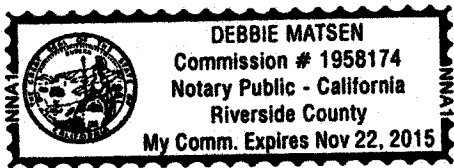

Place Notary Seal Above

Signature Debbie Matsen  
Signature of Notary Public

**OPTIONAL**

Though the information below is not required by law, it may prove valuable to person relying on the document and could prevent fraudulent removal and reattachment of this form to another document.

**Description of Attached Document**

Title or Type of Document Bid Bond, County of Riverside

Document Date: June 27, 2012 Number of Pages: 1 Page

Signer(s) Other Than Named Above: Fidelity and Deposit Company of Maryland

**Capacity(ies) Claimed by Signer(s)**

Signer's Name: Robert Bradley

- Individual
- Corporate Officer — Title(s): Vice President

Partner —  Limited  General

Attorney in Fact

Trustee

Other: \_\_\_\_\_

Signer is Representing: \_\_\_\_\_

All American Asphalt

RIGHT THUMBPRINT OF SIGNER

Top of thumb here

Signer's Name: \_\_\_\_\_

Individual

Corporate Officer — Title(s): \_\_\_\_\_

Partner —  Limited  General

Attorney in Fact

Trustee

Other: \_\_\_\_\_

Signer is Representing: \_\_\_\_\_

RIGHT THUMBPRINT OF SIGNER

Top of thumb here

**CALIFORNIA ALL-PURPOSE ACKNOWLEDGMENT**

State of California

County of Orange

On 6/27/2012

Date

before me, A. Wilkison, Notary Public

Here Insert Name and Title of the Officer

personally appeared Rebecca Haas-Bates

Name(s) of Signer(s)

who proved to me on the basis of satisfactory evidence to be the person(s) whose name(s) is/are subscribed to the within instrument and acknowledged to me that he/she/they executed the same in his/her/their authorized capacity(ies), and that by his/her/their signature(s) on the instrument the person(s), or the entity upon behalf of which the person(s) acted, executed the instrument.

I certify under PENALTY OF PERJURY under the laws of the State of California that the foregoing paragraph is true and correct.

WITNESS my hand and official seal.

Signature

*A. Wilkison*

Signature of Notary Public

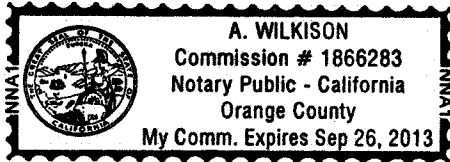

Place Notary Seal Above

**OPTIONAL**

Though the information below is not required by law, it may prove valuable to persons relying on the document and could prevent fraudulent removal and reattachment of this form to another document.

**Description of Attached Document**

Title or Type of Document: Bid Bond

Document Date: 6/27/2012

Number of Pages: One (1)

Signer(s) Other Than Named Above: All American Asphalt

**Capacity(ies) Claimed by Signer(s)**

Signer's Name: Rebecca Haas-Bates

- Individual
- Corporate Officer — Title(s): \_\_\_\_\_
- Partner —  Limited  General
- Attorney in Fact
- Trustee
- Guardian or Conservator
- Other: \_\_\_\_\_

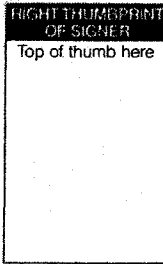

Signer Is Representing: \_\_\_\_\_  
Fidelity and Deposit Company of Maryland

Signer's Name: \_\_\_\_\_

- Individual
- Corporate Officer — Title(s): \_\_\_\_\_
- Partner —  Limited  General
- Attorney in Fact
- Trustee
- Guardian or Conservator
- Other: \_\_\_\_\_

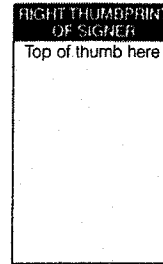

Signer Is Representing: \_\_\_\_\_

**Power of Attorney  
FIDELITY AND DEPOSIT COMPANY OF MARYLAND**

KNOW ALL MEN BY THESE PRESENTS: That the FIDELITY AND DEPOSIT COMPANY OF MARYLAND, a corporation of the State of Maryland, by FRANK E. MARTIN JR., Vice President, and ERIC D. BARNES, Assistant Secretary, in pursuance of authority granted by Article VI, Section 2, of the By-Laws of said Company, which are set forth on the reverse side hereof and are hereby certified to be in full force and effect on the date hereof, does hereby nominate, constitute and appoint **William SYRKIN, Rebecca HAAS-BATES, Sergio D. BECHARA, Richard ADAIR and P. BAUER, all of Glendale, California, EACH** its true and lawful agent and Attorney-in-Fact, to make, execute, seal and deliver, for, and on its behalf as surety, and as its act and deed, ~~any and all bonds and undertakings~~, and the execution of such bonds or undertakings in pursuance of these presents, shall be as binding upon said Company, as fully and amply, to all intents and purposes, as if they had been duly executed and acknowledged by the regularly elected officers of the Company at its office in Baltimore, Md. in their own proper persons. This power of attorney revokes that issued on behalf of Richard ADAIR, P. BAUER, dated February 25, 2010.

The said Assistant Secretary does hereby certify that the extract set forth on the reverse side hereof is a true copy of Article VI, Section 2, of the By-Laws of said Company, and is now in force.

IN WITNESS WHEREOF, the said Vice-President and Assistant Secretary have hereunto subscribed their names and affixed the Corporate Seal of the said FIDELITY AND DEPOSIT COMPANY OF MARYLAND, this 27th day of June, A.D. 2011.

ATTEST:

**FIDELITY AND DEPOSIT COMPANY OF MARYLAND**



*Eric D. Barnes*

Eric D. Barnes      Assistant Secretary

*Frank E. Martin Jr.*

By: Frank E. Martin Jr.      Vice President

State of Maryland }  
City of Baltimore } ss:

On this 27th day of June, A.D. 2011, before the subscriber, a Notary Public of the State of Maryland, duly commissioned and qualified, came FRANK E. MARTIN JR., Vice President, and ERIC D. BARNES, Assistant Secretary of the FIDELITY AND DEPOSIT COMPANY OF MARYLAND, to me personally known to be the individuals and officers described in and who executed the preceding instrument, and they each acknowledged the execution of the same, and being by me duly sworn, severally and each for himself depose and saith, that they are the said officers of the Company aforesaid, and that the seal affixed to the preceding instrument is the Corporate Seal of said Company, and that the said Corporate Seal and their signatures as such officers were duly affixed and subscribed to the said instrument by the authority and direction of the said Corporation.

IN TESTIMONY WHEREOF, I have hereunto set my hand and affixed my Official Seal the day and year first above written.



*Constance A. Dunn*

Constance A. Dunn      Notary Public  
My Commission Expires: July 14, 2015

## Company Profile

# FIDELITY AND DEPOSIT COMPANY OF MARYLAND

1400 AMERICAN LANE, 19TH FLOOR TOWER 1  
SCHUAMBURG, IL 60196-1056  
800-382-2150

### Agent for Service of Process

KAREN HARRIS, C/O CORPORATION SERVICE COMPANY 2710 GATEWAY OAKS DRIVE, SUITE 150N  
SACRAMENTO, CA 95833-3505

Unable to Locate the Agent for Service of Process?

### Reference Information

NAIC #:	39306
NAIC Group #:	<u>0212</u>
California Company ID #:	2479-4
Date authorized in California:	January 01, 1982
License Status:	UNLIMITED-NORMAL
Company Type:	Property & Casualty
State of Domicile:	MARYLAND

### Lines of Insurance Authorized to Transact

The company is authorized to transact business within these lines of insurance. For an explanation of any of these terms, please refer to the glossary.

AIRCRAFT  
AUTOMOBILE  
BOILER AND MACHINERY  
BURGLARY  
CREDIT  
FIRE  
LIABILITY  
MARINE  
MISCELLANEOUS  
PLATE GLASS  
SPRINKLER  
✓ SURETY  
TEAM AND VEHICLE  
WORKERS' COMPENSATION