

**SUBMITTAL TO THE BOARD OF SUPERVISORS
COUNTY OF RIVERSIDE, STATE OF CALIFORNIA**

218



FROM: TLMA - Transportation Department

SUBMITTAL DATE:
January 3, 2013

SUBJECT: Construction of traffic signal at the intersection of Ontario Avenue/Temescal Canyon Road and El Cerrito Road/Minnesota Road, El Cerrito community.

RECOMMENDED MOTION: That the Board of Supervisors:

1. Approve the plans and specifications for the construction of a traffic signal and street improvements at the intersection of Ontario Avenue/Temescal Canyon Road and El Cerrito Road/Minnesota Road, El Cerrito community.
2. Authorize the Clerk to advertise for bids to be received in the office of the Director of Transportation up to the hour of 2:00 PM, Wednesday, February 6, 2013, at which time bids will be opened.

Juan C. Perez
Director of Transportation and Land Management

JCP:jrj:rr
(Continued On Attached Page)

FINANCIAL DATA	Current F.Y. Total Cost:	\$ 516,550	In Current Year Budget:	Yes
	Current F.Y. Net County Cost:	\$ 0	Budget Adjustment:	No
	Annual Net County Cost:	\$ 0	For Fiscal Year:	2012/2013

SOURCE OF FUNDS: West County DIF Signal Mitigation Fund (100%) There are no General Funds used in this project.	Positions To Be Deleted Per A-30	<input type="checkbox"/>
	Requires 4/5 Vote	<input type="checkbox"/>

C.E.O. RECOMMENDATION:

APPROVE

BY
Tina Grande

County Executive Office Signature

FORM APPROVED COUNTY COUNSEL BY NEAL R. KIPNIS DATE 1/31/13 Departmental Concurrence

Dep't Recomm.: Policy Policy
Per Exec. Ofc.: Consent Consent

MINUTES OF THE BOARD OF SUPERVISORS

On motion of Supervisor Ashley, seconded by Supervisor Stone and duly carried by unanimous vote, IT WAS ORDERED that the above matter is approved as recommended.

Ayes: Jeffries, Tavaglione, Stone, Benoit and Ashley
 Nays: None
 Absent: None
 Date: January 15, 2013
 xc: Transp.

Kecia Harper-Ihem
Clerk of the Board
By:
Deputy

Prev. Agn. Ref. 7/23/12 Item 3.19 | District: 2/2 | Agenda Number:

ATTACHMENTS FILED
WITH THE CLERK OF THE BOARD

3-14

The Honorable Board of Supervisors

RE: Construction of traffic signal at the intersection of Ontario Avenue/Temescal Canyon Road and El Cerrito Road/Minnesota Road, El Cerrito community.

January 3, 2013

Page 2 of 2

BACKGROUND: The Transportation Improvement Program provides for the construction of a traffic signal at the intersection of Ontario Avenue/Temescal Canyon Road and El Cerrito Road/Minnesota Road in the El Cerrito community. The proposed traffic signal will improve safety by providing protected traffic movements and pedestrian crossings.

Additionally, the project includes installing signing and striping, a new raised median with colored stamped concrete, new ADA compliant curb ramps, construction of driveway approaches, curb and gutter, sidewalk, bus stop pad, pavement reconstruction, installation of a new asphalt parking lot, and an onsite waste water treatment system on private property.

These proposed improvements are within the County's right of way (ROW) and partially within privately owned property; accordingly, ROW acquisition was necessary on the northeast corner of Temescal Canyon Road and Minnesota Road. The Board of Supervisors authorized the acquisition of property to build the proposed improvements on July 31, 2012 (Item 3.19) through a negotiation with the property owner to convey 128 square feet in permanent easement. As part of the consideration for this conveyance, the County will replace the existing parking lot, install a new onsite waste water treatment system, and relocate the business sign to another portion of the property.

Annual traffic signal operation and maintenance costs are estimated at \$5,500 to be funded from gas tax.

The submitted plans and specifications have been approved as to form by County Counsel.

Environmental clearance is complete.

Project Number: B7-0767

COUNTY OF RIVERSIDE
DEPARTMENT OF TRANSPORTATION

ONTARIO AVENUE / TEMESCAL CANYON ROAD
AND
EL CERRITO ROAD / MINNESOTA ROAD

CONSTRUCTION OF TRAFFIC SIGNALS, PARKING LOT, AND
ASSOCIATED IMPROVEMENTS

EL CERRITO COMMUNITY

PROJECT No. B7-0767

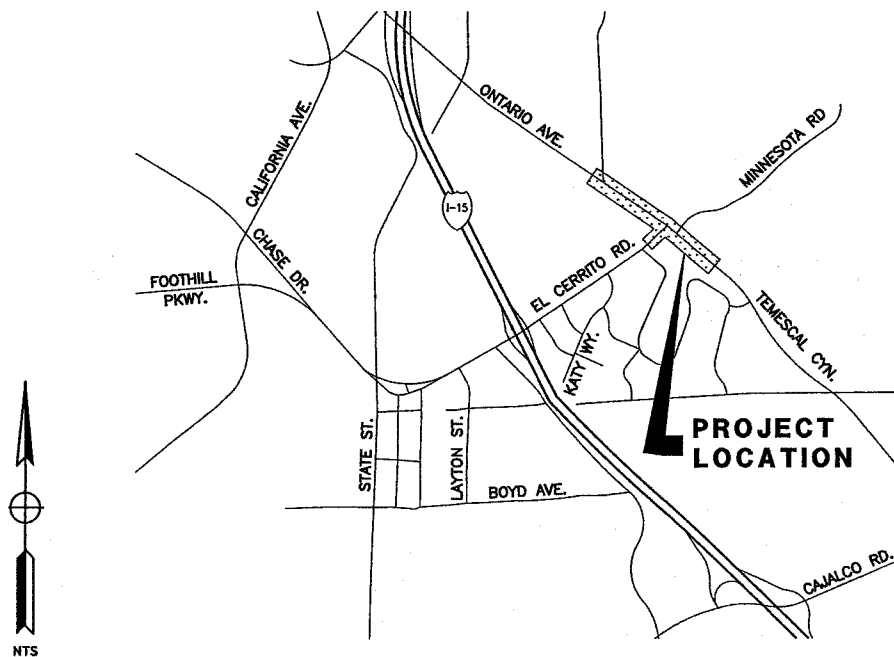
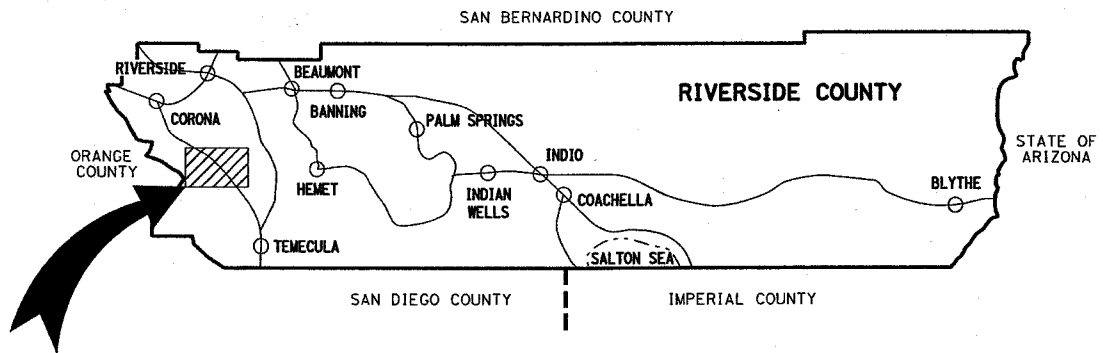

VICINITY MAP

TOWNSHIP 4S RANGE 6W SECTION 8
COUNTY ROAD BOOK PAGE No. 30-B



OFFICE OF
CLERK OF THE BOARD OF SUPERVISORS
1st FLOOR, COUNTY ADMINISTRATIVE CENTER
P.O. BOX 1147, 4080 LEMON STREET
RIVERSIDE, CA 92502-1147
PHONE: (951) 955-1060
FAX: (951) 955-1071

KECIA HARPER-IHEM
Clerk of the Board of Supervisors

KIMBERLY A. RECTOR
Assistant Clerk of the Board

January 17, 2013

THE PRESS ENTERPRISE
ATTN: LEGALS
PO BOX 792
RIVERSIDE, CA 92501

FAX (951) 368-9018
E-MAIL: legals@pe.com

**RE: NOTICE INVITING BIDS: Traffic Signal at Ontario Ave / Temescal Canyon Road
B7-0767**

To Whom It May Concern:

Attached is a copy for publication in your newspaper for **TEN (10) TIMES:**

Sunday	- January 20, 2013	Friday	- January 25, 2013
Monday	- January 21, 2013	Saturday	- January 26, 2013
Tuesday	- January 22, 2013	Sunday	- January 27, 2013
Wednesday	- January 23, 2013	Monday	- January 28, 2013
Thursday	- January 24, 2013	Tuesday	- January 29, 2013

We require your affidavit of publication immediately upon completion of the last publication.

Your invoice must be submitted to this office in duplicate, WITH TWO CLIPPINGS OF THE PUBLICATION.

NOTE: PLEASE COMPOSE THIS PUBLICATION INTO A SINGLE COLUMN FORMAT.

Thank you in advance for your assistance and expertise.

Sincerely,

Mcgil

Cecilia Gil, Board Assistant to
KECIA HARPER-IHEM, CLERK OF THE BOARD

Gil, Cecilia

From: mtinajero@pe.com on behalf of Master, PEC Legals <legalsmaster@pe.com>
Sent: Wednesday, January 16, 2013 4:29 PM
To: Gil, Cecilia
Subject: Re: [Legals] FOR PUBLICATION: Bids for Ontario Ave & Temescal Canyon Rd B7-0767

Received for publication from Jan. 20 to Jan. 29. Proof with cost to follow.

On Wed, Jan 16, 2013 at 4:18 PM, Gil, Cecilia <CCGIL@rcbos.org> wrote:

Hello! Attached is a Notice Inviting Bids, for publication from Jan. 20 to Jan. 29, 2013. Please confirm. THANK YOU!

Cecilia Gil

Board Assistant to the
Clerk of the Board of Supervisors
[951-955-8464](tel:951-955-8464)

THE COUNTY ADMINISTRATIVE CENTER IS CLOSED EVERY FRIDAY UNTIL FURTHER NOTICE.

PLEASE CONSIDER THE ENVIRONMENT BEFORE PRINTING.

--

Please note, we will be closed 1/21/13 in observance of the Martin Luther King Holiday. Our deadlines are as follows:

Martin Luther King Deadlines	
Publication Date	Date to be submitted to the PE
Jan 17, 2013	Jan 17, 2013
Jan 18, 2013	Jan 18, 2013

Thank You!
Legal Advertising



Publisher of The Press-Enterprise



OFFICE OF
CLERK OF THE BOARD OF SUPERVISORS
1st FLOOR, COUNTY ADMINISTRATIVE CENTER
P.O. BOX 1147, 4080 LEMON STREET
RIVERSIDE, CA 92502-1147
PHONE: (951) 955-1060
FAX: (951) 955-1071

KECIA HARPER-IHEM
Clerk of the Board of Supervisors

KIMBERLY A. RECTOR
Assistant Clerk of the Board

January 17, 2013

RIVERSIDE COUNTY RECORD
ATTN: LEGALS
PO BOX 3187
RIVERSIDE, CA 92519

FAX (951) 685-2961
E-MAIL: recordmde@aol.com

**RE: NOTICE INVITING BIDS: Traffic Signal at Ontario Ave / Temescal Canyon Road
B7-0767**

To Whom It May Concern:

Attached is a copy for publication in your newspaper for **TWO (2) TIMES:**

Thursday – January 24, 2013
Thursday – January 31, 2013

We require your affidavit of publication immediately upon completion of the last publication.

Your invoice must be submitted to this office in duplicate, WITH TWO CLIPPINGS OF THE PUBLICATION.

NOTE: PLEASE COMPOSE THIS PUBLICATION INTO A SINGLE COLUMN FORMAT.

Thank you in advance for your assistance and expertise.

Sincerely,

Mcgil

Cecilia Gil, Board Assistant to
KECIA HARPER-IHEM, CLERK OF THE BOARD

Gil, Cecilia

From: Michael Evans <recordmde@aol.com>
Sent: Thursday, January 17, 2013 11:25 AM
To: Gil, Cecilia
Subject: Re: FOR PUBLICATION: Bids for Ontario Ave. & Temescal Canyon Rd. B7-0767

Good Morning,

Just go to work. Sorry I was late getting back to you. But I have received the notice for publication.

Thank and have a nice day.

Mike

-----Original Message-----

From: Gil, Cecilia <CCGIL@rcbos.org>
To: recordmde <recordmde@aol.com>
Sent: Thu, Jan 17, 2013 8:38 am
Subject: FW: FOR PUBLICATION: Bids for Ontario Ave. & Temescal Canyon Rd. B7-0767

Good morning! I still have not received confirmation for this.

Cecilia Gil

Board Assistant to the
Clerk of the Board of Supervisors
951-955-8464

*THE COUNTY ADMINISTRATIVE CENTER IS CLOSED EVERY FRIDAY UNTIL FURTHER NOTICE.
PLEASE CONSIDER THE ENVIRONMENT BEFORE PRINTING.*

From: Gil, Cecilia
Sent: Wednesday, January 16, 2013 4:19 PM
To: recordmde@aol.com
Subject: FOR PUBLICATION: Bids for Ontario Ave. & Temescal Canyon Rd. B7-0767

Hello Mike!

Notice of Inviting Bids, for publication on Jan. 24 and 31, 2013. Please confirm. THANK YOU!

Cecilia Gil

Board Assistant to the
Clerk of the Board of Supervisors
951-955-8464

*THE COUNTY ADMINISTRATIVE CENTER IS CLOSED EVERY FRIDAY UNTIL FURTHER NOTICE.
PLEASE CONSIDER THE ENVIRONMENT BEFORE PRINTING.*

NOTICE INVITING BIDS

County of Riverside, herein called Owner, invites sealed proposals for:

**ONTARIO AVENUE / TEMESCAL CANYON ROAD
AND
EL CERRITO ROAD / MINNESOTA ROAD
CONSTRUCTION OF TRAFFIC SIGNALS, PARKING LOT, AND
ASSOCIATED IMPROVEMENTS**

EL CERRITO COMMUNITY

PROJECT NO. B7-0767

Proposal shall be delivered to the Riverside County Transportation Department, 14th Street Annex, 3525 14th Street, Riverside, California 92501, telephone (951) 955-6780 not later than 2:00 p.m., on **Wednesday, February 6, 2013**, to be promptly opened in public at said address. Each proposal shall be in accordance with plans, specifications, and other contract documents, dated **December 2012**, and prepared by County of Riverside, whose address is same as the above, from whom they may be obtained upon deposit of **\$30** per set plus mailing. No refund. Prospective bidders may preview the plans, specifications and other contract documents, at no charge prior to purchase, at the above noted location.

The Contractor is required to have a Class "A" license at the time of bid submission.

Engineering Estimate	\$464,500.00 - \$542,500.00
Bid Bond	10%
Performance Bond	100%
Payment Bond	100%
Working Days	55 Working Days

Dated: January 17, 2013

Kecia Harper-Ihem, Clerk of the Board
By: Cecilia Gil, Board Assistant

SPECIFICATIONS and CONTRACT DOCUMENTS

for the CONSTRUCTION

of

ONTARIO AVENUE / TEMESCAL CANYON ROAD
AND
EL CERRITO ROAD / MINNESOTA ROAD

CONSTRUCTION OF TRAFFIC SIGNALS, PARKING LOT, AND
ASSOCIATED IMPROVEMENTS

EL CERRITO COMMUNITY

PROJECT NO. B7-0767



FORM APPROVED COUNTY COUNSEL
BY *[Signature]* DATE 1/3/13
NAME: KIPNIE

TRANSPORTATION DEPARTMENT

JAN 15 2013 3-14 pgs

**ONTARIO AVENUE / TEMESCAL CANYON ROAD
AND
EL CERRITO ROAD / MINNESOTA ROAD
CONSTRUCTION OF TRAFFIC SIGNALS, PARKING LOT, AND
ASSOCIATED IMPROVEMENTS
EL CERRITO COMMUNITY
PROJECT NO. B7-0767**

SPECIFICATIONS AND CONTRACT DOCUMENTS

For the construction of

**ONTARIO AVENUE / TEMESCAL CANYON ROAD
AND
EL CERRITO ROAD / MINNESOTA ROAD**

**CONSTRUCTION OF TRAFFIC SIGNALS, PARKING LOT, AND
ASSOCIATED IMPROVEMENTS**

EL CERRITO COMMUNITY

PROJECT NO. B7-0767

Contract Approvals:

Approved by:



Khalid Nasim,
Engineering Division Manager

12/5/12

Date

Engineering Certification:

These specifications, special provisions, and estimates have been prepared by or under the direction of the following Registered Civil Engineer:



Dowling Tsai, P.E.
County Project Manager

12/5/12

Date

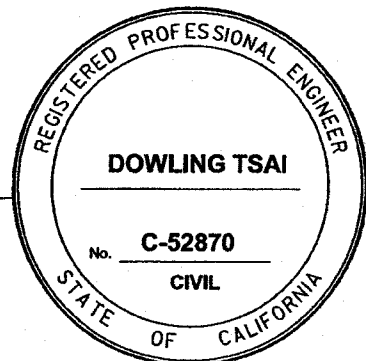

SPECIFICATIONS AND CONTRACT DOCUMENTS

For the construction of

**ONTARIO AVENUE / TEMESCAL CANYON ROAD
AND
EL CERRITO ROAD / MINNESOTA ROAD**

**CONSTRUCTION OF TRAFFIC SIGNALS, PARKING LOT, AND
ASSOCIATED IMPROVEMENTS**

EL CERRITO COMMUNITY

PROJECT NO. B7-0767

Onsite Wastewater Treatment System Special Provision

The Onsite Wastewater Treatment System special provision has been prepared by or under the direction of the following Registered Civil Engineer:

Onsite Wastewater Treatment System only

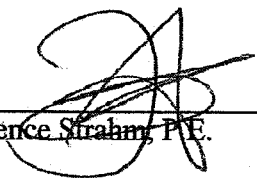

Lawrence Strahm, P.E.

12/5/2012
Date



SPECIFICATIONS AND CONTRACT DOCUMENTS

For the construction of

**ONTARIO AVENUE / TEMESCAL CANYON ROAD
AND
EL CERRITO ROAD / MINNESOTA ROAD**

**CONSTRUCTION OF TRAFFIC SIGNALS, PARKING LOT, AND
ASSOCIATED IMPROVEMENTS**

EL CERRITO COMMUNITY

PROJECT NO. B7-0767

Water Pollution Control Special Provision:

Reviewed and Recommended by:

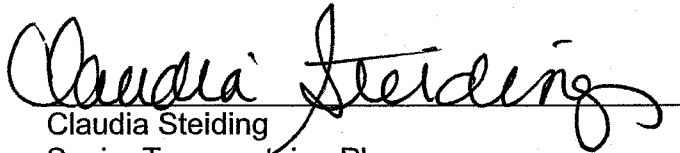

Claudia Steiding
Senior Transportation Planner
NPDES Coordinator
Riverside County Transportation Department

Date

COUNTY OF RIVERSIDE
DEPARTMENT OF TRANSPORTATION

ONTARIO AVENUE / TEMESCAL CANYON ROAD

AND

EL CERRITO ROAD / MINNESOTA ROAD

CONSTRUCTION OF TRAFFIC SIGNALS, PARKING LOT, AND
ASSOCIATED IMPROVEMENTS

EL CERRITO COMMUNITY

PROJECT No. B7-0767

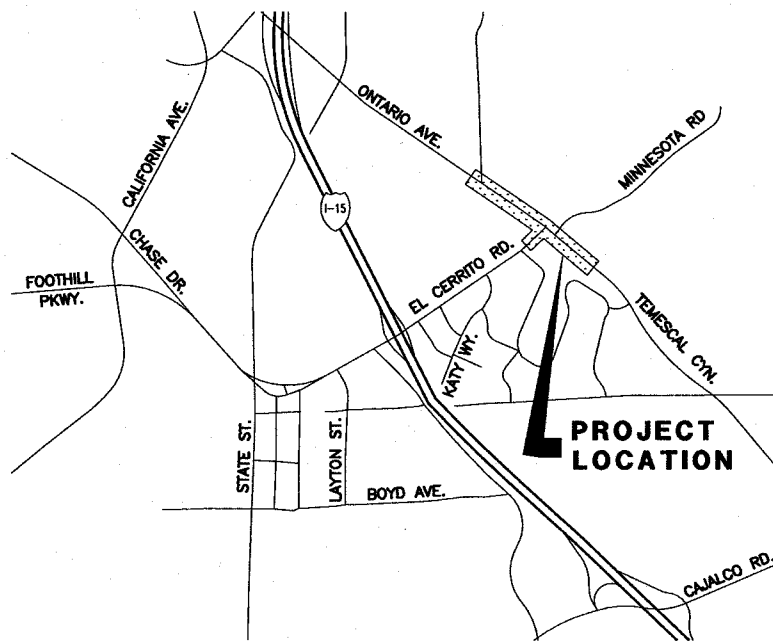
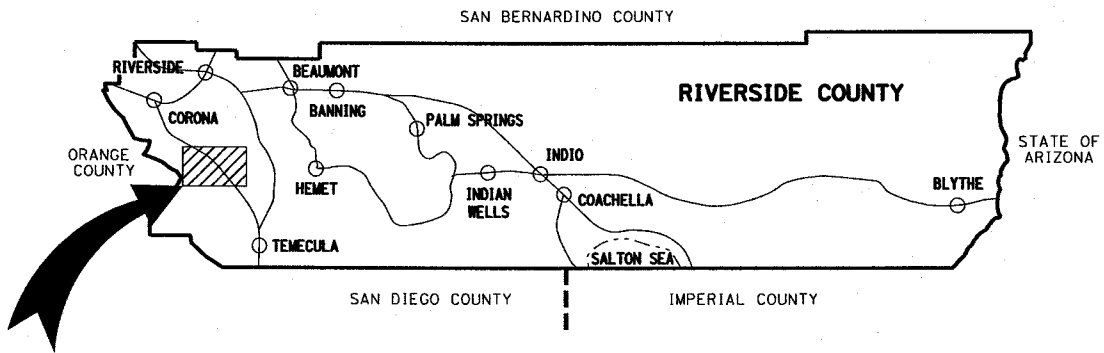

VICINITY MAP

TOWNSHIP 48 RANGE 6W SECTION 8
COUNTY ROAD BOOK PAGE No. 30-B

TABLE OF CONTENTS

	<u>PAGE</u>
Notice Inviting Bids	
Instruction to Bidders.....	A1-A7
Contractor's Proposal.....	B1-B5
Non-Collusion Affidavit.....	B6
Bid Bond.....	B7
Agreement.....	C1-C3
Performance Bond.....	C4
Payment Bond.....	C5
General Conditions.....	1-21
Definitions.....	1
Standard Specifications.....	1
Director of Transportation.....	2
Site Inspection.....	3
Protection of Premises.....	4
Change Orders.....	5
Substitution of Equals.....	6
Final Inspection - Notice of Completion.....	7
Termination of Contracts.....	7
Payments and Monthly Estimates.....	8
Force Account Payment.....	9
Final Payment.....	10
Damages.....	10
Documents of Contractor.....	11
Responsibility of Contractor in Emergency.....	11
Labor Code.....	11
Obstructions.....	12
Insurance - Hold Harmless.....	12
Equal Employment Opportunity.....	15
Deposit of Securities.....	16
Assignment of Claims.....	17
Claims Resolution.....	17
Dust Abatement.....	18
AQMD Recommendations.....	22-47
Special Provisions.....	48-131
Attachments	
Reference Drawings, Standards	

Table of Contents

SPECIAL PROVISIONS	48
DESCRIPTION:	48
SPECIFICATIONS:	48
SURVEY STAKING	48
DISPOSAL OF EXCESS EXCAVATION OR MATERIALS:	49
RECORD DRAWINGS:	49
COOPERATION:	50
LIQUIDATED DAMAGES:	51
PARTIAL PAYMENTS:	51
CONSTRUCTION PROJECT FUNDING IDENTIFICATION SIGNS:	52
ITEMS OF WORK:	52
ORDER OF WORK:	52
PROJECT APPEARANCE:	53
TRAFFIC CONTROL SYSTEM/ PUBLIC CONVENIENCE/ PUBLIC SAFETY:	53
MAINTAINING TRAFFIC:	55
GRAFFITI REMOVAL AND CLEANING:	56
DEVELOP WATER SUPPLY:	57
WATER POLLUTION CONTROL (SANTA ANA RIVER BASIN REGION):	58
STREET SWEEPING:	60
CLEARING AND GRUBBING:	62
REMOVE TREES:	63
ROADWAY EXCAVATION:	64
COLD PLANE AND WEDGE PLANE ASPHALT CONCRETE PAVEMENT:	65
ROUT AND SEAL RANDOM CRACKS:	66
AGGREGATED BASE:	67
HOT MIX ASPHALT CONCRETE (TYPE A):	68
COMPENSATION ADJUSTMENTS FOR PRICE INDEX FLUCTUATIONS:	76
FOG SEAL COAT OVER PARKING LOT:	77
ASPHALT CONCRETE DIKE:	77
MINOR CONCRETE CURB RAMPS, DRIVEWAY APPROACHES, CURBS, GUTTERS, SIDEWALKS, BUS PAD, AND BUS TURNOUT:	78
MINOR CONCRETE COLORED STAMPED CONCRETE:	80
UNDER SIDEWALK DRAIN:	82
RELOCATE SIGN STRUCTURE:	82
REMOVE TRAFFIC STRIPE AND PAVEMENT MARKINGS:	82
THERMOPLASTIC STRIPE AND PAVEMENT MARKING:	83
PAINT TRAFFIC STRIPE:	84
REMOVE AND SALVAGE ROADSIDE SIGNS:	84
RELOCATE SIGN:	85
ROADSIDE SIGN:	85
DELINEATORS	86

Table of Contents

PAVEMENT MARKERS:	87
PARKING BUMPERS:	87
STEEL GUARD POST (CONCRETE FILLED):.....	88
ROOT BARRIER:	89
ONSITE WASTEWATER TREATMENT SYSTEM.....	90
MISCELLANEOUS DIRECTED WORK:	92
DE-MOBILIZATION:	92
SIGNAL AND LIGHTING	93
<i>A. General</i>	93
<i>B. Start of Work</i>	93
<i>C. County Furnished Equipment</i>	93
<i>D. Equipment Orders</i>	94
<i>E. Equipment List and Drawings</i>	94
<i>F. Warranties, Guaranties, Instruction Sheets, and Manuals</i>	95
<i>G. Maintaining Existing and Temporary Electrical Systems</i>	95
<i>H. Foundations</i>	96
<i>I. Standards, Steel Pedestals and Posts</i>	96
<i>J. Conduits</i>	97
<i>K. Pull Boxes</i>	98
<i>L. Conductors and Wiring</i>	98
<i>M. Blank</i>	99
<i>N. Bonding and Grounding</i>	99
<i>O. Service</i>	99
<i>P. Testing</i>	100
<i>Q. Controller Assembly</i>	101
<i>R. Vehicle Signal Assemblies</i>	103
<i>S. Pedestrian Signal Assemblies</i>	105
<i>T. Pedestrian, Bicycle and Equestrian Push Buttons</i>	110
<i>U. Detectors</i>	111
<i>V. Luminaries</i>	118
<i>W. Blank</i>	118
<i>X. Internally Illuminated Street Name Sign</i>	118
<i>Y. Photoelectric Controls</i>	119
<i>Z. Emergency Vehicle Preemption System</i>	119
<i>AA. Blank</i>	123
<i>BB. Battery Backup System</i>	123
<i>CC. Blank</i>	131
<i>DD. Payment Method</i>	131

NOTICE INVITING BIDS

County of Riverside, herein called Owner, invites sealed proposals for:

**ONTARIO AVENUE / TEMESCAL CANYON ROAD
AND
EL CERRITO ROAD / MINNESOTA ROAD
CONSTRUCTION OF TRAFFIC SIGNALS, PARKING LOT, AND
ASSOCIATED IMPROVEMENTS
EL CERRITO COMMUNITY
PROJECT NO. B7-0767**

Proposal shall be delivered to the Riverside County Transportation Department, 14th Street Annex, 3525 14th Street, Riverside, California 92501, telephone (951) 955-6780 not later than 2:00 p.m., on Wednesday, February 06, 2013, to be promptly opened in public at said address. Each proposal shall be in accordance with plans, specifications, and other contract documents, dated December 2012, and prepared by County of Riverside, whose address is same as the above, from whom they may be obtained upon deposit of \$30 per set plus mailing. No refund. Prospective bidders may preview the plans, specifications and other contract documents, at no charge prior to purchase, at the above noted location.

The Contractor is required to have a Class "A" license at the time of bid submission.

Dated: January 15, 2013

Kecia Harper-Ihem, Clerk of the Board

By: _____
Deputy

INSTRUCTIONS TO BIDDERS

1. **Form of Proposal.** The proposal must be made on the form of Contractor's Proposal which is included in the Contract Documents and must be completely filled in, dated and signed. If provision is made for alternates, they must all be bid, unless otherwise provided in the Special Provisions.

2. **Bid Bond.** The proposal must be accompanied by a 10% Bid Bond, using the form provided in the Contract Documents, or by a certified or cashier's check payable to the order of County in an amount not less than 10% of the amount bid, inclusive of alternates.

3. **Submission of Proposal.** A proposal must be submitted in a sealed opaque envelope which clearly identifies the bidder and the project. Bids must be received by the time and at the place set forth in the Notice Inviting Bids and may be withdrawn only as stated in the proposal. **Bids shall be completed in ink.**

4. **Contract Documents.** The complete Contract Documents are identified in the Agreement. Potential bidders are cautioned that the successful bidder incurs duties and obligations under all of the Contract Documents and that they should not merely examine the Plans and Specifications in making their bid.

5. **License.** To be considered for award of the contract, a potential bidder must have the kind of license required under provisions of the California Business and Professions Code for the work covered in this proposal. This includes joint ventures.

Each item of work will be performed by a Contractor which is qualified and properly licensed for that work.

Pursuant to California Labor Code Section 3099, certification is required for all persons who perform work as electricians for Contractors licensed as Class C-10 Electrical Contractors. Proof of certification shall be provided to the County before the start of construction.

6. **Quantities.** The amount of work to be done or materials to be furnished under the Contract as shown in the Contractor's Proposal are but estimates and are not to be taken as an expressed or an implied statement that the actual amount of work or materials will correspond to the estimate.

County reserves the right to increase or decrease or to entirely eliminate certain items from the work or materials to be furnished if such action is found to be desirable or expedient.

Contractor is cautioned against the unbalancing of his bid by prorating his overhead only into one or two items when there are a number of items listed in the schedule.

7. **Interpretation of Documents.** Discrepancies, omissions, ambiguities, requirements likely to cause disputes between trades and similar matter shall be promptly brought to the attention of the County of Riverside in writing. When appropriate, Addenda will be issued by County.

If the Bidder requires clarification or interpretation of the Bidding Documents, the Bidder shall make a written request to the County by a Request for Information (RFI). All requests for information must be submitted, in writing, between the hours of 8:00 AM and 5:00 PM on any day, Monday through Thursday (except holidays), up to, including and no later than the fifth (5th) day prior to Bid Closing Deadline, by hand delivery, mail, fax or electronic mail. The County of Riverside will not respond to Requests for Information submitted after that time, unless the County determines, at its sole discretion, which it is in the best interest of the public and the County to do so. Requests for Information should be addressed to County of Riverside, Transportation Department, Attn: Joel Jimenez; 3525 14th Street, Riverside, CA 92501, facsimile (951) 955-3164, electronic mail: jjimenez@rctlma.org

No communication by anyone as to such matters except by an Addendum affects the meaning or requirements of the Contract Documents.

8. **ADDENDA.** County reserves the right to issue Addenda to the Contract Documents at any time prior to the time set to open bids. Each potential bidder shall leave with the County Transportation Department his name and address for the purpose of receiving Addenda to be mailed or delivered to such names at such addresses. **To be considered, a Contractor's Proposal must list and take into account all issued Addenda.**
9. **Inspection of Site.** Bidders must examine the site and acquaint themselves with all conditions affecting the work. By making his bid a bidder warrants that he has made such site examination as he deems necessary as to the condition of the site, its accessibility for materials, workmen and utilities and ability to protect existing surface and subsurface improvements. No claim for allowances - time or money - will be allowed as to such matters.

10. **Bonds.** The County requires a 100% Payment Bond and 100% Performance Bond from the successful bidder. All Bonds must be on County's forms contained in the Contract Documents.

The bonds must be underwritten by a Surety Company, which is admitted to transact the business of insurance in the State of California, and which carries a rating in the current issue of Best's Insurance Guide of "A" or better with a financial size of at least "VIII". The bond forms included in the project documents shall be used. All signatures on the bonds shall be notarized. Bonds shall be provided with an executed Power of Attorney issued by the surety.

11. **Bids.** Bids are required for the entire work, including all alternate bid schedules, if applicable, unless otherwise explicitly allowed in the bid documents. The amount of the bid for comparison purposes will be the total of all items. The total of unit basis items will be determined by extension of the item price bid on the basis of the estimated quantity set forth for the item.

The bidder shall set forth for each item of work in clearly legible figures, an item price and a total for the item in the respective spaces provided for this purpose. In the case of unit basis items, the amount set forth under the "Total" column shall be the extension of the item price bid on the basis of the estimated quantity for the item.

In case of discrepancy between the item price and the total set forth for the item, the item price shall prevail, provided, however, if the amount set forth as an item price is ambiguous, unintelligible or uncertain for any cause, or is omitted, or in the case of unit basis items, is the same amount as the entry in the "Total" column, then the amount set forth in the "Total" column for the item shall prevail in accordance with the following:

- a. As to lump sum items, the amount set forth in the "Total" column shall be the item price.
- b. As to unit basis items, the amount set forth in the "Total" column shall be divided by the estimated quantity for the item and the price thus obtained shall be the item price.

The bidder is advised that the items of work may be grouped into bid schedules, and that certain bid items may be listed in more than one bid schedule, and with different bid item numbers, and the following shall apply thereto:

The bidder is directed to submit the same bid amount for all contract bid items that are listed with the same item code and item description. Said bid items are referred to herein as "Like Bid Items".

“Like Bid Items” shall be considered a single bid item for purposes of calculating increased and decreased quantities, and as otherwise applicable in Section 4-1.03, “Changes” of the Standard Specifications.

The following are not subject to this bidding requirement:

1. Bid items with the same item code but different item descriptions.
2. Bid items that are measured as “lump sum” or “force account”.
3. Alternate bid schedules.

In the event that a bidder submits different unit bid amounts for “Like Bid Items”, as described above, the bid will be corrected by applying the lowest of the unit bid amounts to all the respective “Like Bid Items”.

No bidder may withdraw his bid for a period of ninety (90) days after the bid opening.

12. **Award of Contract.** The County reserves the right to reject all bids received. Acceptance by the governing body of the County by resolution or minute order at a meeting regularly called and held of a Contractor's Proposal constitutes an award of the contract and the execution of the Agreement is a written memorial thereof.

The County of Riverside will submit the contract documents to the low responsive and responsible bidder for execution prior to award utilizing the following procedures and requirements:

- a. A bidder whose proposal is accepted shall execute the formal construction agreement with the County of Riverside, similar to the form attached hereto as a sample, and shall return said agreement, together with approved performance and payment bonds and with complete evidence of insurance as required elsewhere herein, including executed additional insured endorsements and waivers of subrogation, within ten (10) working days from the date of the Notice of Acceptance of Proposal and Intent to Award as issued by the Transportation Department. All submittals shall meet the requirements of the bid documents. Corrections, if required, shall be made and the revised documents shall be resubmitted within two (2) working days of Contractor's receipt of review comments.
- b. The contract bonds and insurance documentation shall be submitted in accordance with the contract requirements prior to submission to the County of Riverside Board of Supervisors for award by the Transportation Department, and prior to the performance of any work under the contract.

- c. If a Bidder to whom a Notice of Acceptance of Proposal and Intent to Award has been issued, fails or refuses to sign a construction agreement, or to furnish the bonds or insurance certificates and endorsements as required within the prescribed period of time as described above, the County of Riverside may, at its sole discretion, rescind the Notice of Acceptance, and the bid guarantee submitted by that Contractor shall become the property of the County of Riverside as prescribed in the bid documents and as allowed by law.
 - d. If it is in the best interest of the County of Riverside, the County reserves the right to award the contract prior to execution by the Contractor. Thereafter, County shall mail or deliver to the lowest responsible bidder the agreement for Contractor's execution and return.
- 13. **Return of Guarantee.** Bid bonds will not be returned unless specifically requested by the bidder. Any submitted negotiable securities of unsuccessful bidders will be returned by mail within 30 days of the award of a contract to the successful bidder. Any submitted negotiable security of the successful bidder will be returned by mail within 30 days of receipt by the County of executed contract, certificate of insurance, performance bond and payment Bond.
- 14. **Subletting and Subcontracting.** Bidders are required pursuant to the Subletting and Subcontracting Fair Practices Act (commencing with Section 4100 of the Public Contracts Code) to list in their proposal the name and location of place of business of each subcontractor who will perform work or labor or render services in or about the construction of the work or improvement or a subcontractor who specifically fabricates and installs a portion of the work or improvement according to detailed drawings contained in the Plans and Specifications in excess of 1/2 of 1% of this prime Contractor's total bid. Failure to list a subcontractor for a portion of the work means that the prime Contractor will do that portion of the work. It is the County's intent for the Subletting and Subcontracting Fair Practice Act to apply to all phases of the work.
- 15. **Qualifications of Bidders.** No award will be made to any bidder who cannot give satisfactory assurance to the Board of Supervisors as to his own ability to carry out the contract, both from his financial standing and by reason of his previous experience as a Contractor on work of the nature contemplated in the contract. The bidder may be required to submit his record of work of similar nature to that proposed under these specifications, and unfamiliarity with the type of work may be sufficient cause for rejection of bid.
- 16. **Contract Participation.** Riverside County's M/W/DVBE Contract Participation Program affirms the utilization and participation of qualified minority, women and disabled veteran firms in its contracting and procurement activities. The County

encourages general and prime Contractors to afford competitive subcontracting opportunities to minority, women and disabled veteran firms where possible, in their contracting and procurement activities with the County of Riverside.

17. **Hours of Work.** Attention is directed to Section 8-1.06, "Time of Completion" and Section 7-1.01A (1), "Hours of Labor" of the Standard Specifications.

Daily working hours shall be between the hours of 7:00 a.m. and 6:00 p.m., Monday through Friday, except legal holidays, as approved by the Engineer. Exceptions and specific work schedules shall be submitted to the Engineer for consideration.

18. **Labor Code.** Pursuant to the Labor Code, the governing board of the Owner has obtained from the Director of the Department of Industrial Relations, State of California, his determinations of general prevailing rates of per diem wages applicable to the work, and for holiday, and overtime work, including employer payments for health and welfare, pensions, vacation and similar purpose, as set forth on schedule which is on file at the principal office of the Owner, and which will be made available to any interested person upon request.

19. **Alternate Bid Schedules.** If the Proposal includes bid items listed under a Base Bid Schedule and one or more Alternate Bid Schedules, the following shall apply: The County may award only the items of work listed on the Base Bid Schedule, or may choose to award some or all of the Alternate Bid Schedules in addition to the Base Bid Schedule. Unless otherwise specified, the basis of the selection of the lowest bid shall be the lowest responsive and responsible bid for the sum of all Bid Schedules.

If the Proposal includes bid items listed under two or more Alternate Bid Schedules with no Base Bid Schedule, the following shall apply: This project contains Alternate Bid Schedules that may or may not be mutually exclusive, as described elsewhere in the bid documents. The County may award the items of work listed on one or more of the Alternate Bid Schedules. In the case of mutually exclusive Alternate Bid Schedules, only one of the Alternate Bid Schedules will be selected for award. Unless otherwise specified, the basis of the selection of the lowest bid shall be the lowest responsive and responsible bid for the sum of all Bid Schedules.

The County also reserves the right to reject all bids received.

20. **Dust Abatement.** Attention is directed to Section 23, "Dust Abatement" with regard to the dust abatement provisions of the contract.

21. **Submission of Insurance Certificate.** Within ten (10) working days of the date of the Notice of Acceptance of Proposal and Intent to Award issued by the County of Riverside, the successful Contractor shall submit a certificate of insurance, including required endorsements, which provides evidence that the bidding Contractor has insurance coverage that meets the requirements of Section 18 of the General Conditions. Failure to have complete insurance coverage in place and to provide all required certificates and endorsements within the specified ten (10) working days period will be grounds for declaring the bidder to not be in compliance with the bid documents, rescinding the Notice of Acceptance, making a claim against the bid bond, and awarding to the second low bidder, at the sole discretion of the County.

CONTRACTOR'S PROPOSAL

TO: COUNTY OF RIVERSIDE

DATE: _____

hereafter called "County":

BIDDER: _____

(hereafter called "Contractor")

THE UNDERSIGNED, Contractor, having carefully examined the site and the Contract Documents for the construction of Ontario Avenue / Temescal Canyon Road and El Cerrito Road / Minnesota Road Construction of Traffic Signals, Parking Lot and Associated Improvements, El Cerrito Community Project No. B7-0767 hereby proposes to construct the work in accordance with the Contract Documents, including Addenda Nos. _____ for the amount stated in this Proposal.

By submitting this Proposal, Contractor agrees with County:

1. That unless withdrawn in person by Contractor or some person authorized in writing by Contractor not by telephone or telegram before the time specified in the Notice Inviting Bids for the public opening of bids, this Proposal constitutes an irrevocable offer for 90 calendar days after that date.
2. County has the right to reject any or all Proposals and to waive any irregularities or informalities contained in a Proposal.
3. To execute the Agreement and deliver the Faithful Performance Bond, Payment Bond and Insurance Certificate with endorsements, which comply with the requirements set forth in the Instructions to Bidders and General Conditions, within ten (10) working days of the date of the Notice of Acceptance of Proposal and Intent to Award as issued by the County of Riverside.
4. That the contract shall be awarded upon a resolution or minute order to that effect duly adopted by the governing body of County; and that execution of the Contract Documents shall constitute a written memorial thereof.
5. To submit to County such information as County may require to determine whether a particular Proposal is the lowest responsible bid submitted.

6. That the accompanying certified or cashier's check or Bid Bond is in an amount not less than 10% of the total bid submitted and constitutes a guarantee that if awarded the contract, Contractor will execute the Agreement and deliver the required bonds within ten (10) days after notice of award. If Contractor fails to execute and deliver said documents, the check or bond is to be charged with the costs of the resultant damages to County, including but not limited to publication costs, the difference in money between the amount bid and the amount in excess of the bid which it costs County to do or cause to be done the work involved, lease and rental costs, additional salaries and overhead, increased interest and costs of funding the project, attorney expense, additional engineering and architectural expense and cost of maintaining or constructing alternate facilities occasioned by the failure to execute and deliver said documents.
7. By signing this proposal the Contractor certifies that the representations made therein are made under penalty of perjury.

**ONTARIO AVENUE / TEMESCAL CANYON ROAD
AND
EL CERRITO ROAD / MINNESOTA ROAD**

**CONSTRUCTION OF TRAFFIC SIGNALS, PARKING LOT, AND ASSOCIATED IMPROVEMENTS
EL CERRITO COMMUNITY**

PROJECT NO. B7-0767

PROPOSAL

ITEM No.	ITEM CODE	ITEM	UNIT	ESTIMATED QUANTITY	ITEM PRICE (IN FIGURES)	TOTAL (IN FIGURES)
1	066102	DUST ABATEMENT	LS	1		
2	074020	WATER POLLUTION CONTROL	LS	1		
3	120100	TRAFFIC CONTROL SYSTEM	LS	1		
4	160101	CLEARING AND GRUBBING	LS	1		
5	160120	REMOVE TREE	EA	18		
6	190101	ROADWAY EXCAVATION	CY	575		
7	260201	CLASS 2 AGGREGATE BASE	CY	380		
8	390130	HOT MIX ASPHALT (TYPE A)	TON	570		
9	011508	COLD PLANE ASPHALT CONCRETE PAVEMENT (.17')	SQYD	490		
10	013903	PLACE ASPHALT CONCRETE DIKE (CRS 212) (6")	LF	35		
11	013904	PLACE ASPHALT CONCRETE DIKE (CRS 212) (8")	LF	45		
12	017315	MINOR CONCRETE (CURB RAMP) (CRS 403 - CASE A)	EA	1		
13	017316	MINOR CONCRETE (CURB RAMP) (CRS 403 - CASE B)	EA	4		
14	017310	MINOR CONCRETE (DRIVEWAY APPROACH) (CRS 207)	SQFT	400		
15	000003	MINOR CONCRETE (DRIVEWAY APPROACH) (CRS 207A)	SQFT	2,350		
16	017304	MINOR CONCRETE (CURB AND GUTTER) (CRS 200)	LF	440		
17	017309	MINOR CONCRETE (TYPE "D" CURB) (CRS 204)	LF	590		
18	731521	MINOR CONCRETE (SIDEWALK)	SQFT	680		
19	000003	MINOR CONCRETE (BUS STOP PAD)	SQFT	540		
20	731535	MINOR CONCRETE (BUS TURNOUT) (CRS 814)	SQFT	765		
21	731519	MINOR CONCRETE (STAMPED CONCRETE)	SQFT	300		
22	011503	UNDER SIDEWALK DRAIN CAST IN PLACE (CRS 309)	EA	1		
23	152394	RELOCATE SIGN STRUCTURE	EA	1		
24	860201	SIGNAL AND LIGHTING	LS	1		
25	150717	REMOVE TRAFFIC STRIPE AND PAVEMENT MARKING	SQFT	2,495		
26	840515	THERMOPLASTIC PAVEMENT MARKING	SQFT	800		
27	840656	PAINT TRAFFIC STRIPE (2-COAT)	LF	6,000		

PROPOSAL

ITEM No.	ITEM CODE	ITEM	UNIT	ESTIMATED QUANTITY	ITEM PRICE (IN FIGURES)	TOTAL (IN FIGURES)
28	150740	REMOVE SIGN	EA	15		
29	066148	RELOCATE SIGNS	EA	8		
30	566011	ROADSIDE SIGN - ONE POST	EA	17		
31	820107	DELINEATOR (CLASS 1)	EA	4		
32	568001	INSTALL SIGN (STRAP AND SADDLE BRACKET METHOD)	EA	2		
33	850102	PAVEMENT MARKER (REFLECTIVE)	EA	290		
34	842000	PARKING BUMPER (PRECAST CONCRETE)	EA	8		
35	869050	GUARD POST	EA	4		
36	150608	REMOVE CHAIN LINK FENCE	LF	180		
37	800360	CHAIN LINK FENCE (TYPE CL-6)	LF	100		
38	205062	ROOT BARRIER	LF	100		
39	000003	ONSITE WASTEWATER TREATMENT SYSTEM	LS	1		
40	000003	MISCELLANEOUS DIRECTED WORK	FA	1	30,000.00	30,000.00
41	019901	DE-MOBILIZATION	LS	1	22,000.00	22,000.00

PROJECT TOTAL: _____ \$ _____

ITEMS 1-41

"WORDS"

BIDDER DATA:

Name of Bidder _____

Type of Organization _____

Person(s) Authorized to Sign for Bidder _____

Address _____

Phone _____

Contractor's License Type & Number _____

Expiration Date _____

8. **DESIGNATION OF SUBCONTRACTORS:** Contractor submits the following complete list of each subcontractor who will perform work or labor or render service in or about the construction in an amount in excess of 1/2 of 1% of the total bid.

<u>ITEM</u>	<u>SUBCONTRACTOR</u>	<u>ADDRESS</u>	<u>LICENSE NO.</u>
-------------	----------------------	----------------	--------------------

Percent of work to be performed by sub-contractors: ___%
(Note: 50% of the work required to be performed by general contractor)

IN WITNESS WHEREOF Contractor executed this Proposal as of the date set forth on Page 1 of this proposal.

TITLE _____
"Contractor"

Non-Collusion Declaration

To be executed by bidder and submitted with bid. (Public Contract Code Section 7106)

The undersigned declares:

I am the _____ (Title) of _____ (Company),
the party making the foregoing bid.

The bid is not made in the interest of, or on behalf of, any undisclosed person, partnership, company, association, organization, or corporation. The bid is genuine and not collusive or sham. The bidder has not directly or indirectly induced or solicited any other bidder to put in a false or sham bid. The bidder has not directly or indirectly colluded, conspired, connived, or agreed with any bidder or anyone else to put in a sham bid, or that anyone shall refrain from bidding. The bidder has not in any manner, directly or indirectly, sought by agreement, communication, or conference with anyone to fix the bid price of the bidder or any other bidder, or to fix any overhead, profit, or cost element of the bid price, or of that of any other bidder.

All statements contained in the bid are true. The bidder has not, directly or indirectly, submitted his or her bid price of any breakdown thereof, or the contents thereof, or divulged information or data relative thereto, to any corporation, partnership, company, association, organization, bid depository, or to any member or agent thereof to effectuate a collusive or sham bid, and has not paid, and will not pay, any person or entity for such purpose.

Any person executing this declaration on behalf of a bidder that is a corporation, partnership, joint venture, limited liability company, limited liability partnership, or any other entity, hereby represents that he or she has full power to execute, and does execute, this declaration on behalf of the bidder.

I declare under penalty of perjury under the laws of the State of California that the foregoing is true and correct and that this declaration is executed on

_____ (Month) _____ (Day) of _____ (Year),

at _____ (City), California.

Signature of Declarant: _____

Printed name of Declarant: _____

Name of Bidder (Company): _____

Title or Office: _____

Note: Notarization of signature required.

Check box if attachment is included.

Bid Bond

Recitals:

1. _____ "Contractor", has submitted his/her Contractor's Proposal to County of Riverside, "County", for the construction of public work for **Ontario Ave / Temescal Canyon Road and El Cerrito Road / Minnesota Road Construction of Traffic Signals, Parking Lot, and Associated Improvements, El Cerrito Community, Project No. B7-0767** in accordance with a Notice Inviting Bids from the County.
2. _____ a _____ corporation, hereafter called "Surety", is the surety of this bond.

Agreement:

We, Contractor as Principal and Surety as Surety, jointly and severally agree and state as follows:

1. The amount of the obligation of this bond is 10% of the amount of the Contractor's Proposal, including bid alternates, and inures to the benefit of County.
2. This Bond is exonerated by (1) County rejecting said Proposal or, in the alternate, (2) if said Proposal is accepted, Contractor executes the Agreement and furnishes the Bonds as agreed to in its Proposal, otherwise it remains in full force and effect for the recovery of loss, damage and expense of County resulting from failure of Contractor to act as agreed to in its Proposal. Some types of possible loss, damage and expense are specified in the Contractor's Proposal.
3. Surety, for value received, stipulates and agrees that its obligations hereunder shall in no way be impaired or affected by any extension of time within which County may accept the Proposal and waives notice of any such extension.
4. This Bond is binding on our heirs, executors, administrators, successors and assigns.

Dated: _____

Signatures:

By: _____ By: _____

Title: Attorney in Fact "Surety" Title: _____ "Contractor"

STATE OF _____
COUNTY _____
OF _____

} ss. SURETY'S ACKNOWLEDGEMENT

On _____ before me, _____ personally appeared, _____ known to me, or proved to me on the basis of satisfactory evidence, to be the person whose name is subscribed to the within instrument and acknowledged to me that he/she executed the same in his/her authorized capacities, and that by his/her signature on the instrument the person, or the entity upon behalf of which the person acted, executed the instrument.

WITNESS my hand and official seal.

Signature of Notary Public

Notary Public (Seal)

Note: This Bond must be executed by both Contractor and Surety with corporate seal affixed. All signatures must be notarized. (Attach acknowledgements).

AGREEMENT

THIS AGREEMENT is entered into at Riverside, California as of the date set forth below is between County of Riverside hereafter called "County" and _____ hereafter called "Contractor".

WITNESSETH

RECITALS:

1. Contractor has submitted to County his Contractor's Proposal for the construction of County Project, _____
in strict accordance with the Contract Documents identified below and County has accepted said Proposal.
2. Contractor states that he has reexamined his Contractor's Proposal and found it to be correct, has ascertained that his subcontractors are properly licensed and possess the requisite skill and forces, has reexamined the site and Contract Documents and is of the opinion that he can presently do the work in accordance with the Contract Documents for the money set forth in his Proposal to be paid as provided in the Contract Documents.

AGREEMENT:

IT IS AGREED BY THE PARTIES AS FOLLOWS:

1. Contract Documents. The entire contract consists of the following: (a) The Agreement. (b) The Notice Inviting Bids. (c) The Instruction to Bidders. (d) The Contractor's Proposal. (e) The Bid Bond. (f) The Payment Bond. (g) The Performance Bond. (h) The General Conditions. (i) The Special Provisions. (j) The Standard Specifications of the State of California Department of Transportation edition of May 2006 as modified in other portions of the Contract Documents. (k) The Standard Plans of the Department of Transportation identified on the plans or in the Special Provisions. (l) The Plans. (m) Addenda No. _____. (n) The Determination of Prevailing Wage Rates for Public Work. (o) Any Change Orders issued. (p) Any additional or supplemental specifications, notice, instructions and drawings issued in accordance with the provisions of the Contract Documents. All of said Documents presently in existence are by this reference incorporated herein with like effect as if here set forth in full and upon the proper issuance of other documents they shall likewise be deemed incorporated. The Bid Bond is exonerated upon execution of this Agreement and the Payment Bond and Faithful Performance Bond.
2. The Work. Contractor shall do all things necessary to construct the work generally described in Recital No. 1 in accordance with the Contract Documents.

3. Liquidated Damages and Time of Completion. Attention is directed to the provisions in Section 8-1.06, "Time of Completion", and in Section 8-1.07, "Liquidated Damages", of the Standard Specifications and these Special Provisions.

The Contractor shall begin work within 15 days of the date stated within the written "Notice to Proceed".

The Contractor shall notify the Engineer, in writing, of his intent to begin work at least 72 hours before work is begun. The notice shall be delivered to the Transportation Department's Construction Engineer and shall specify the date the Contractor intends to start. If the project has more than one location of work, a separate notice shall be given for each location.

Should the Contractor begin work in advance of receiving a written "Notice to Proceed", any work performed by him in advance of the date stated in the "Notice to Proceed" shall be considered as having been done by him at his own risk and as a volunteer and subject to the following:

- (1) The Contractor shall, on commencing operations, take all precautions required for public safety and shall observe all the provisions in the Specifications and the Special Provisions.
 - (2) All work done according to the contract prior to the issuance of the "Notice to Proceed", will be considered authorized work and will be paid for as provided in the contract.
 - (3) The Contractor shall not be entitled to any additional compensation or an extension of time for any delay, hindrance or interference caused by or attributable to commencement of work prior to the issuance of the "Notice to Proceed".
4. Compensation. Contractor shall be paid in the manner set forth in the Contract Documents the amount of his Proposal as accepted by County, the above rates, subject to additions and deductions as provided in the Contract Documents. Said Proposal is on file in the Office of the Clerk of the Board of Supervisors of County.

ONTARIO AVENUE / TEMESCAL CANYON ROAD AND
EL CERRITO ROAD / MINNESOTA ROAD
CONSTRUCTION OF TRAFFIC SIGNALS, PARKING LOT, AND
ASSOCIATED IMPROVEMENTS

EL CERRITO COMMUNITY

PROJECT NO. B7-0767

IN WITNESS WHEREOF the parties hereto have executed this agreement as of the date set forth below.

COUNTY OF RIVERSIDE

CONTRACTOR

BY _____
Chairman, Board of Supervisors

BY _____

Dated _____

TITLE: _____
(If Corporation, Affix Seal)

ATTEST:

Kecia Harper-Ihem, Clerk of the Board

ATTEST:

BY _____
Deputy

TITLE: _____

Licensed in accordance with an act
providing for the registration of
Contractors,

License No. _____

Federal Employer Identification Number:

"County"
(Seal)

"Corporation"
(Seal)

PERFORMANCE BOND

Recitals:

1. _____ (Contractor) intend to enter into an Agreement with COUNTY OF RIVERSIDE (County) for construction of public work known as _____.
2. _____, a _____ corporation (Surety), is the Surety under this Bond.

Agreement:

We, Contractor, as Principal, and Surety, as Surety, jointly and severally agree, state, and are bound unto County, as obligee, as follows:

1. The amount of the obligation of this Bond is 100% of the estimated contract price for the Project of \$_____ and inures to the benefit of County.
2. This Bond is exonerated by Contractor doing all things to be kept and performed by it in strict conformance with the Contract Documents for the Project, otherwise it remains in full force and effect for the recovery of loss, damage and expense of County resulting from failure of Contractor to so act. All of said Contract Documents are incorporated herein.
3. This obligation is binding on our successors and assigns.
4. For value received, Surety stipulates and agrees that no change, time extension, prepayment to Contractor, alteration or addition to the terms and requirements of the Contract Documents or the work to be performed thereunder shall affect its obligations hereunder and waives notice as to such matters, except the total contract price cannot be increased by more than 10% without approval of Surety.

THIS BOND is executed as of _____.

By _____

By _____

By _____

Type Name _____

Its Attorney in Fact
"Surety"

Title _____
"Contractor"

(Corporate Seal)

(Corporate Seal)

NOTE: This Bond must be executed by both parties with corporate seal affixed. All signatures must be acknowledged. (Attach acknowledgements).

Payment Bond

(Public Work - Civil Code 9550 et seq.)

The makers of this Bond are _____, as Principal and Original Contractor and _____, a corporation, authorized to issue Surety Bonds in California, as Surety, and this Bond is issued in conjunction with that certain public works contract to be executed between Principal and COUNTY OF RIVERSIDE a public entity, as Owner, for \$ _____, the total amount payable. The amount of this bond is one hundred percent (100%) of said sum. Said contract is for public work generally consisting of _____.

The beneficiaries of this Bond are as is stated in 9554 of the Civil Code and requirements and conditions of this Bond are as is set forth in 9554, 9558, 9564 and 9560 of said code. Without notice, Surety consents to extension of time for performance, change in requirements, amount of compensation, or prepayment under said contract.

Dated: _____

Original Contractor – Principal

Surety

By _____

By _____

Title _____

Its Attorney In Fact

(If corporation, affix seal)

(Corporate Seal)

(Corporate Seal)

STATE OF _____
COUNTY OF _____

}

ss. SURETY'S ACKNOWLEDGEMENT

On _____ before me, _____ personally appeared, _____, known to me, or proved to me on the basis of satisfactory evidence, to be the person whose name is subscribed to the within instrument and acknowledged to me that he executed the same in his authorized capacities, and that by his signature on the instrument the person, or the entity upon behalf of which the person acted, executed the instrument.

WITNESS my hand and official seal.

Signature of Notary Public

Notary Public (Seal)

NOTE: This Bond must be executed by both parties with corporate seal affixed. All signatures must be acknowledged. (Attach acknowledgements).

GENERAL CONDITIONS

SS 1. DEFINITIONS:

- a. "County", "Contractor", and "Contract Documents" are identified in the Agreement. "County" and "Contractor" includes their authorized representatives are treated throughout as if each were singular in number. "Contractor" includes its surety.
- b. "Engineer" and "Director of Transportation" means the Director of Transportation for the County of Riverside, and includes his authorized representatives.
- c. "Plans" means the portion of the Contract Documents consisting of all drawings prepared for the direction and characteristics of the work. A schedule of said drawings which constitutes the plans as of the execution of the Agreement is set forth in the Special Provisions and are supplemented by the Standard Plans referred to in the Special Provisions.
- d. "State of California", "Department of Transportation" and "Director of Transportation", means the County of Riverside.

SS 2. STANDARD SPECIFICATIONS:

The Standard Specifications of the State of California Department of Transportation, edition of May 2006 hereafter called "Standard Specifications", are incorporated herein as modified in these General Conditions, the Special Provisions and the Plans.

The following subsections of the Standard Specifications are deleted:

1-1.13, 1-1.15, 1-1.18, 1-1.25, 1-1.37, 1-1.40, 2-1.01, 2-1.05, 2-1.07, 5-1.14, 7-1.165, 8-1.03, 9-1.05, 9-1.065, 9-1.10, 12-2.02.

Section 3 of the Standard Specifications is deleted.

The following deletions and additions are made from the following subsections of the Standard Specifications.

Subsection 5-1.04, add to the second paragraph at its end the following sentence: "The General Conditions govern over all of the Contract Documents except the Special Provisions, the Agreement and Bonds."

Subsection 7-1.01A (2), strike the last sentence of the second paragraph and in its place read: "These wage rates are on file in the Office of the County Clerk and are a part of the Contract."

Subsection 7-1.15, for "Director" read "Director of Transportation" except for last reference read "County of Riverside".

Subsection 7-1.16, delete references to Subsection 7-1.165.

Subsection 8-1.06, strike the last paragraph.

Subsection 8-1.08, strike "as provided in the State Contract Act".

SS 3. DIRECTOR OF TRANSPORTATION:

All work shall be done under the supervision of the Director of Transportation who shall determine the amount, quality, acceptability and fitness of all parts of the work, and interpret the Contract Documents. No act or omission of the Director of Transportation relieves Contractor of the duty to proceed with the work in strict conformity with the Contract Documents.

Upon request, Director of Transportation shall reduce to writing any oral order, objection, requirement or determination. Whenever Director of Transportation's approval is required it shall be in writing only.

All communications to County by Contractor shall be via Director of Transportation.

No work shall be performed on site other than during normal working hours without the knowledge and consent of Director of Transportation.

When in Director of Transportation's opinion, weather or other conditions are such that attempts to perform a portion of the work will probably result in work not in accordance with the Contract Documents, he shall so advise Contractor. When Contractor advises Director of Transportation that he intends to proceed despite such advise, he does so at his peril. The Director of Transportation may then order Contractor, in writing which specifies the portion of the work involved and the conditions warranting the issuance of the order, not to proceed on such portion of the work if (1) proceeding will in his judgment have an adverse effect on Contractor's ability to complete the work within the stipulated time period, or (2) proceeding will in his judgment necessitate

unusual tests and procedures to ascertain whether said portion of the work is in accordance with the Contract Documents. Contractor shall comply with such orders at its expense.

Nothing herein contained relieves Contractor from the duty to make independent determinations as to weather and other conditions affecting the proper completion of the work.

Failure for any reason of Director of Transportation to advise Contractor as to such matters, or to issue an order as above provided, does not relieve Contractor from the duty to accomplish the work in accordance with the Contract Documents.

As stated elsewhere, amounts shown in the Proposal and Agreement as to quantities are but estimates only. From time to time Director of Transportation shall direct Contractor as to the prosecution of the work in such a manner as to increase or decrease such estimates as to the work actually to be done. Contractor shall comply with such instructions and shall be paid only for work actually done based on the unit price set out in the Agreement.

SS 4. SITE INSPECTION - EFFECT OF OTHER IMPROVEMENTS SHOWN AND CONTRACTOR PROCEDURE:

Elsewhere in the Contract Documents reference may be made, graphically, descriptively or both, to the existence or possible existence of other improvements affecting the site and the prosecution of the work such as surface and subsurface utilities, drainage ditches and courses, buildings, fencing, retaining walls, roadways, curbs, trees, shrubs, and similar matters. Such matters are included to be used by Contractor to the extent he deems appropriate. However, it is expressly understood and agreed:

- a. Showing or describing such items does not mean that it is an exhaustive and complete presentation and that as to matters shown or described that they necessarily exist.
- b. All graphic presentations are schematic only unless the contrary is clearly set out elsewhere as to a particular matter.
- c. Whenever in the plans survey markers are shown, boundaries of the site are shown or contour lines are shown, Contractor may assume that such matters are shown in accordance with acceptable standards.

All improvements of the nature above described, whether elsewhere shown or described or not, shall, unless the contrary is elsewhere specifically directed, remain in place, undisturbed and suitably protected during the course of the work.

Whenever during the course of the work a subsurface improvement is discovered which Contractor believes is unknown to County, he shall immediately so inform Director of Transportation. Except as elsewhere provided, whenever in the course of the work it becomes apparent that the work cannot proceed without the destruction or relocation of any improvement, whether shown or described or not, Contractor shall immediately cease work affecting such improvements and notify Director of Transportation as to such circumstance and await instructions as to how to proceed.

- d. The Contractor shall be required to cooperate fully with all utility forces or forces of other public agencies engaged in relocation, lowering, altering or otherwise rearranging any facilities interfering with the progress of work or installing any facilities thereon.

The Contractor will also be required to cooperate fully with any County or State forces working on or near the project, or requiring access to the work in the performance of their duties.

SS 5. USE OF AND PROTECTION OF PREMISES AND REMOVAL OF DEBRIS:

At his expense Contractor shall:

- a. Take every precaution against injuries to persons or damage to property.
- b. Comply with regulations governing the use of the property.
- c. Store and suitably protect his apparatus, equipment, materials and supplies in an orderly fashion on site.
- d. Place on the work only such loads as are consistent with the safety of the work.
- e. Effect all cutting, fitting, or patching of his work required to make it conform to the Plans and Specifications and interrelate with other improvements or except with the consent of Director of

Transportation, cut or otherwise alter existing improvements.

- f. Protect and preserve established bench marks and monuments, make no changes in the location of such without the prior written approval of County, replace and relocate any of them which may be lost or destroyed or which require shifting because of necessary changes in grades or locations. All replacement and relocation work shall be accomplished only after approval of County and under the direct supervision and instruction of Director of Transportation.
- g. Before final payment remove all surplus materials, false work, temporary structures, debris, and similar matter resulting from his operations from the site and to put the site in an orderly condition.
- h. Construct, operate and maintain all passageways, guard fences, lights, barricades and other facilities required for protection by State or municipal laws and regulations and local conditions during the course of the work.
- i. Guard County's property from injury or loss.
- j. Take all reasonable precautions for dust and noise control and generally conduct operations so as not to constitute a nuisance.
- k. The Contractor shall be responsible for the protection of existing signs, fences, concrete curb and gutter and other highway facilities which may be encountered in the roadway. The replacement or repair of any facilities which the County deems necessary as a result of the Contractor's operations shall be done by the Contractor at his own expense and to the satisfaction of the County Transportation Department.

SS 6. CHANGE ORDERS - DETAIL DRAWINGS AND INSTRUCTIONS:

Reference is made to 4-1.03 and 4-1.03A of the Standard Specifications regarding change orders. Wherever in these subsections the word "Engineer" appears read "County".

Each approved change order shall be considered as an amendment to the Contract Documents and will not be considered approved until executed by the Board of Supervisors, except Director of Transportation can approve certain change orders without the necessity of approval by

the Board as provided in a Resolution of the Board adopted March 30, 1993, Resolution Number 93-047.

The above does not limit the ability of Director of Transportation to issue further detail drawings, explanations and instructions which are customarily given by an Engineer during the course of similar work. Director of Transportation will furnish Contractor with reasonable promptness such further detailed explanations, instructions and drawings as may be necessary for the proper execution of the work, and Contractor shall conform to same provided they are consistent with the intent of the Contract Documents. In giving such additional instructions, explanations and drawings Director of Transportation has authority to make minor changes in the work which do not involve extra cost and are not inconsistent with the Contract Documents.

Contractor's acting on such instructions, explanations and drawings of Director of Transportation means that Contractor agrees that such explanations, instructions and drawings are within the scope of the work in accordance with the intent of the Contract Documents and do not constitute a basis for modification of the Contract Documents as to price or time.

SS 7. BRAND OR TRADE NAME - SUBSTITUTE OF EQUALS:

Reference is made to Section 3400 of the Public Contracts Code, which is by this reference incorporated herein with like effect as if here set forth in full.

If a potential bidder believes he knows of an equal to a specified brand or trade name which is not mentioned in the Contract Documents, then such potential bidder may so advise Director of Transportation of such fact, giving all relevant information. If appropriate, an addendum will be issued as to the alleged equal provided that such issuance may be accomplished at least 5 days before the time fixed for opening bids.

Unless the subject article or product is expressly designated for matching others in use in a particular public improvement either completed or in the course of completion, any bidder may, as part of its bid proposal, include a request for substitution of an item equal to any specified by brand or trade name.

Within 35 calendar days after award of the contract, Contractor may submit to Director of Transportation data substantiating such a request, and the difference, if any, in cost. Director of Transportation shall promptly investigate the request and make a recommendation to County as to equality. The governing body of County shall promptly determine whether the substitute is equal in every respect

to the item specified, and approve or deny the request accordingly, and shall notify Director of Transportation of the determination made, who shall advise Contractor in writing of the decision. Unless the request is granted, substitution will not be permitted.

Nothing herein shall authorize a change in the contract price or prevent the use of change orders in the manner provided elsewhere in the Contract Documents.

SS 8. FINAL INSPECTION - NOTICE OF COMPLETION:

When the work is ready for final inspection County shall cause the work to be inspected and subjected to such tests as seem to it to be required for the purpose of determining if the work is complete in every respect.

At a meeting of the governing body of County held within 10 days after final inspection, the governing body shall consider the facts developed at the inspection. If it is found that the work is apparently complete in every respect, County will accept the work and a notice of completion will be recorded.

As between the parties, the recordation of the Notice of Completion, unless recorded because of a cessation of labor, means only that the time for final payment and the commencement of the guarantee period commences to run.

SS 9. COUNTY'S RIGHT TO STOP WORK OR TERMINATE THE CONTRACT:

(1) Contractor shall be adjudged bankrupt or make an assignment for the benefit of creditors, or (2) a receiver or liquidator is appointed for Contractor or any of his property, or (3) Contractor shall refuse or fail after Notice of Warning from County by Director of Transportation to supply sufficient properly skilled workmen or suitable materials, or (4) Contractor fails to prosecute the work with such diligence as will insure its completion within the stipulated time period, or (5) Contractor shall fail to make payments to persons supplying labor or materials for the work, or (6) Contractor does not comply with applicable law or instructions of Director of Transportation, or (7) Contractor is otherwise guilty of a substantial violation of any provision of the Contract Documents, then County without prejudice to such other and further right, remedy or relief it may be entitled to, may by 10 days notice to Contractor, terminate the employment of Contractor and his right to proceed, either as to the entire work, or at County's option, as to any portion thereof as to which delay shall have occurred or breach or noncompliance relates, and may thereupon take possession of the affected work and complete

the work by contract or otherwise, as County deems expedient. In such case Contractor shall not be entitled to receive any further payment until the work is finished. If the unpaid balance shall exceed the expense of completion, and other damage, expense or loss of County occasioned by Contractor's failure to properly perform, such excess shall be paid by Contractor. If such expense and damage exceeds the unpaid balance, Contractor is liable to County for the excess. If County elects to proceed under this Section, it may take possession of and utilize in completing the work such materials, supplies, plant and equipment on site which may be necessary or convenient for the purpose of completing the work, County is expressly granted the right - acting via Director of Transportation, an Engineer or otherwise - to operate equipment and machinery on site for the purpose of determining whether it has a basis for proceeding under this section.

If the construction of the project herein is damaged, which damage is determined to have been proximately caused by an act of God, in excess of 5% of the contract amount, provided that the work damaged is built in accordance with applicable building standards and the plans and specifications, then the Owner, upon certification by the Engineer, may, without prejudice to any other right of remedy, terminate the contract.

Decision by County not to proceed under this Section does not constitute a waiver by County of any right it might from time to time have against Contractor under the Contract Documents.

SS 10. PAYMENT AND MONTHLY ESTIMATES:

Director of Transportation, once each month, after said work is commenced and until after the completion and acceptance thereof, shall make and deliver to Contractor duplicate certificates stating the value of work then completed according to the contract, estimated according to the standard of the unit contract price, and thereupon Contractor shall be paid an amount sufficient with all previous payments to make the aggregate ninety five percent (95%) of the amount earned as certified. Maximum value of progress payment retention, as set forth in Section 9-1.06 of the Standard Specifications and any other referenced text, shall be five (5%)."

The partial payments made as the work progresses will be payment on account on work performed as of the 25th of the month and shall in no way be considered as an acceptance of any part of the work or material of the contract, nor shall they in any way govern the final estimate. No such estimate or payment shall be made when in the judgement of the

Director of Transportation the total value of the work done since the last estimate amounts to less than \$300.

For the purpose of timely payment, the "receipt of payment request" date, as described in Public Contract Code 20104.50 and as referred to herein, shall be considered to be the fifth working day following the 25th day of each month.

Within 5 working days of the 25th day of each month the County shall:

- a. Calculate and prepare the certificate ("progress pay estimate") stating the value of the work completed for the billing month, for the purpose of determining the proper progress payment amount.
- b. If a progress pay estimate has been prepared by the County but has been contested by the Contractor as of the "receipt of payment request" date, as defined above, the County shall submit to the Contractor a document setting forth in writing a description of the dispute pertaining to the progress billing, and the County's reason for its position. Said document shall be submitted to the Contractor as soon as practicable, but not later than 7 calendar days after the "receipt of payment request" date.

Any progress pay estimate which is undisputed and remains unpaid for thirty (30) calendar days, after the "receipt of payment request date" shall accrue interest to the Contractor equivalent to the legal rate set forth in subdivision (a) of Section 685.010 of the California Code of Civil Procedure. The number of days available to the County to make a payment without incurring interest pursuant to this section shall be reduced by the number of days by which the County exceeds the seven-day submittal requirement set forth in the paragraph above.

Pursuant to Public Contract Code Section 20104.50, subsection (e), the progress payment date is the date that funds are encumbered and the payment warrant is issued.

SS 11. PAYMENT FOR EXTRA WORK (FORCE ACCOUNT BASIS):

Extra work to be paid for on a force account basis as directed by the Engineer will be paid for as set forth in Section 9-1.03 of the Standard Specifications. The labor surcharge, equipment rental rates and the right of way delay factors for each classification of equipment are listed in the Department of Transportation publication entitled Labor Surcharge and Equipment Rental Rates. A copy of which is on file at the Office of the Director of Transportation and is hereby incorporated herein in its entirety.

SS 12. FINAL PAYMENT:

Within thirty (30) days after the completion of the work and its acceptance by the Board of Supervisors, Director of Transportation will make a proposed final estimate in writing of the quantities of work done under the contract and the value of such work and will submit such estimate to Contractor. Within thirty (30) days thereafter Contractor shall submit to Director of Transportation his written approval of said proposed final estimate or a written statement of all claims which he has for additional compensation claimed to be due under the contract.

On Contractor's approval or if he files no claims within said period of thirty (30) days, Director of Transportation will issue a final written estimate as submitted to Contractor and County shall pay the entire sum so found to be due after deducting there from all previous payments and all amounts to be kept and all amounts to be retained under the provisions of the contract.

If Contractor within said period of thirty (30) days files claims, Director of Transportation will issue as a semi-final estimate the proposed estimate submitted to Contractor and the County will within thirty (30) days pay the sum found due thereon after deducting all prior payments and all amounts to be kept and retained under the provisions of the contract, Director of Transportation shall then consider and investigate Contractor's claims and shall make such revisions in the said estimate as he may find to be due, and shall then make and issue his final written estimate. County will pay the amount so found due after deducting all previous payments and amount to be retained under the contract.

All prior or partial estimates and payments shall be subjected to correction in the final estimate and payment.

The final estimate shall be conclusive and binding against both parties to the contract on all questions relating to the performance of the contract and the amount of work done there under and compensation therefore, except in the case of gross error. Acceptance of final payment constitutes a release of County by Contractor of all claims relating to the work.

SS 13. DAMAGES:

Contractor acknowledges that failure to perform in strict accordance with the Contract Documents will cause County to suffer special damages in addition to cost of completion of the work in accordance with the provisions of the Contract

Documents. Such special damage could include, but is not limited to, lease and rental cost, additional salaries and overhead, interest during construction, attorney expense, additional engineering, and inspection expense and cost of maintaining or constructing alternate facilities.

SS 14. DOCUMENTS OF CONTRACTOR:

Upon demand, Contractor shall make available to County all documents in its possession relevant to the work accomplished or to be accomplished or any demand or claim of Contractor as to County. This includes copies of documents sent by Contractor or others in its possession. Contractor shall further make available to County conformed copies of all documents submitted to the sureties who executed the Bid Bond, Faithful Performance Bond or Payment Bond for the purpose of obtaining the sureties' signature, including any guarantee or indemnification made to such surety by others for such purpose. Contractor shall maintain in his possession all documents relative to the work for three years after Notice of Completion.

SS 15. RESPONSIBILITY OF CONTRACTOR TO ACT IN AN EMERGENCY:

In case of an emergency which threatens loss or injury to property or life, Contractor shall act without previous instructions as the situation may warrant. Contractor shall notify Director of Transportation immediately thereafter. Any compensation claimed by Contractor, together with substantiating documentation shall be submitted to County via Director of Transportation.

SS 16. LABOR CODE:

Reference is made to Chapter 1, Part 7, Division 2 of the California Labor Code (commencing with Section 1720). By this reference said Chapter 1 is incorporated herein with like effect as if it were here set forth in full. The parties recognize that said Chapter 1 deals, among other things with discrimination, penalties and forfeitures, their disposition and enforcement, wages, working hours, and securing worker's compensation insurance and directly effect the method of prosecution of the work by Contractor and subject it under certain conditions to penalties and forfeitures. Execution of the Agreement by the parties constitutes their agreement to abide by said Chapter 1, their stipulation as to all matters which they are required to stipulate as to by the provisions of said Chapter 1, constitutes Contractor's certification that he is aware of the provisions of said Chapter 1 and will comply with them and further constitutes Contractor's certification as

follows: "I am aware of the provisions of Section 3700 of the California Labor Code which require every employer to be insured against liability for worker's compensation or to undertake self-insurance in accordance with the provisions of that Code, and I will comply with such provisions before commencing the performance of the work of this contract." Contractor and his subcontractors shall comply with the provisions of SS 1777.5 of the Labor Code regarding apprentices.

Contractor shall post at each job site during the course of the work a copy of County's "Determination of Prevailing Wage Rates", copies of said Determination are available from County for this purpose.

SS 17. OBSTRUCTIONS:

Attention is directed to Sections 8-1.10, "Utility and Non-Highway Facilities" and 15, "Existing Highway Facilities" of the Standard Specifications and these Special Provisions.

Add the following to the fourth paragraph of Section 8-1.10, "Utility and Non-Highway Facilities", of the Standard Specifications is amended to read:

In the event that the utility facilities mentioned above are not removed or relocated by the times specified and, if in the opinion of the Engineer, the Contractor's operations are delayed or interfered with by reason of the utility facilities not being removed or relocated by said times, the State will compensate the Contractor for such delays to the extent provided in Section 8-1.09, "Right of Way Delays" of the Standard Specifications, and not otherwise, except as provided in Section 8-1.10, "Utility and Non-Highway Facilities" of the Standard Specifications.

SS 18. INSURANCE - HOLD HARMLESS:

In lieu of the provisions of Section 7-1.12 the following shall apply:

Contractor shall not commence work under this contract until he has obtained the insurance required hereunder and satisfactory proof of said insurance has been submitted to and approved by the County of Riverside.

Contractor shall submit to the County of Riverside a Certificate of Insurance, signed by an authorized representative of the Contractor's insurance provider or agency, which certifies to the County that insurance

coverage is provided in accordance with the requirements of this section. The Certificate of Insurance shall include as attachments the required "Waiver of Subrogation" and "Additional Insured" policy endorsements.

I. Workers Compensation Insurance:

Contractor shall procure and maintain during the life of the contract Worker's Compensation Insurance coverage as prescribed by the laws of the State of California. Policy shall include Employers' Liability including Occupational Disease with limits not less than \$1,000,000 per occurrence. Policy shall be endorsed to provide a Borrowed Servant Endorsement, Alternate Employer Endorsement, or Additional Insured Endorsement naming the County of Riverside, its Director's Officers, Special Districts, Board of Supervisors, employees, agents or representatives as Additional Insureds. Policy shall contain a Waiver of Subrogation in favor of the County of Riverside.

Contractor shall further require each of its subcontractors to procure Worker's Compensation Insurance as required by the State while working on the project and the Contractor shall require the subcontractors to endorse the policy to provide a Borrowed Servant Endorsement, Alternate Employer Endorsement, or Additional Insured Endorsement naming the County of Riverside, its Director's Officers, Special Districts, Board of Supervisors, employees, agents or representatives as Additional Insureds. Policy shall contain a Wavier of Subrogation in favor of the County of Riverside.

II. Comprehensive General Liability Insurance:

Contractor shall take out and maintain during the course of the work General Liability Insurance covering bodily injury and property damage insurance and blanket contractual coverage as to the work and obligations covered hereunder. The amount of the insurance shall be in an amount **not less than \$2,000,000**. The policy may be a combined single limit or split limits, but the amount must be no less than \$2,000,000 per occurrence. The insurance carrier must have a current rating of "A" or better by the A.M. Best Company, a financial size of at least "VIII", and be an admitted carrier in the State of California. Any exceptions must be approved in advance by the County of Riverside Risk Management. Said insurance must contain an endorsement the County of Riverside is named as an additional insured as respects the work covered hereunder and **said insurance must not**

contain, as respects the work covered hereunder, any exclusions as to bodily injury or death or property damage arising out of blasting, explosion, or underground damage to wire, pipes, conduits, mains, sewers, tank tunnels or any similar property - i.e. the so-called "x c u" exclusions. The insurance certificate evidencing such insurance must **affirmatively state** that the insurance carrier (s) will give Owner 30 days written notice prior to cancellation of the insurance or a reduction in coverage, and that "County of Riverside--its Director's Officers, Special Districts, Board of Supervisors, employees, agents and representatives" are named as Additional Insureds.

In the alternate to naming County of Riverside as additional insured, Contractor may take out and maintain during the course of the work and until acceptance by County, Owner's Protective Liability Insurance in an amount not less-than \$2,000,000 covering Riverside County.

III. Auto Liability:

If Lessee's vehicles or licensed mobile equipment will be on the premises or used in any manner on behalf of the County, then Lessee shall maintain auto liability insurance for all owned, non-owned or hired automobiles in an amount not less than \$1,000,000 per occurrence combined single limit. Policy shall name the "County of Riverside, its Director's Officers, Special Districts, Board of Supervisors, employees, agents, or representatives" as Additional Insureds.

IV. Hold Harmless:

Contractor shall hold County of Riverside its officers, agent, and employees free and harmless from any liability whatsoever, including wrongful death, based or asserted upon any act or omission of Contractor, its officers, agents, employees or subcontractors relating to or in anywise connected with or arising from the accomplishment of the work, whether or not such acts or omissions were in furtherance of the work required by the Contract Documents and agrees to defend at his expense, including attorney fees, Owner, County of Riverside its officers, agents and employees in any legal action based upon any such alleged acts or omissions.

SS 19. EQUAL EMPLOYMENT OPPORTUNITY:

General:

Contractor shall not discriminate in its recruiting, hiring, promotion, demotion or termination practices on the basis of race, religious creed, color, national origin, ancestry, sex, age or physical handicap in the performance of this Contract shall comply with the provisions of the California Fair Employment Practice Act (commencing with SS 1410 of the Labor Code), the Federal Civil Rights Act of 1964 (P.L. 88-352) and all amendments thereto, Executive Order No. 11246 (30 Federal Register 12319), as amended, and all administrative rules and regulations issued pursuant to said Acts and Order. See particularly 41 Code of Federal Regulation (CFR) Chapter 60.

Contractor shall require each of its subcontractors to comply with the preceding paragraph and shall include in each subcontract language similar to the preceding paragraph.

Contractor shall permit access to its records of employment, employment advertisement, application forms and other pertinent data and records by Owner and any State or Federal agency having jurisdiction for the purpose of investigation to ascertain compliance with this Section.

Owner may assign an affirmative action representative to monitor Contractor and its subcontractor (s) conduct required by this Section, including the right of entry to the construction site for the purpose of obtaining information from persons performing work on the project providing such inspection does not interfere with the progress of the work.

Elsewhere in the Contract Documents specific requirements may be contained covering the same subject matter of this Section. If so, such specific requirements prevail over this Section in case of conflict.

Transactions of \$10,000 or Under:

Contracts and subcontracts not exceeding \$10,000 are exempt from the requirements of this Section. No Contractor or subcontractor shall procure supplies and/or services in less than usual quantities to avoid applicability of this Section. With respect to contracts and subcontractors for indefinite quantities, this Section applies unless the amount required in any one year under such contract will reasonably be expected not to exceed \$10,000.

Transactions in Excess of \$10,000, but Less Than \$50,000:

At Owner's request, Contractor shall certify that it has in effect an affirmative action plan and agrees to comply with all State and Federal laws and regulations regarding Fair Employment Practices. Contractor shall maintain a written copy of its affirmative action plan and furnish Owner a copy of the plan upon request. Owner may require Contractor to complete an Affirmative Action Compliance Report, on a form furnished by Owner, setting forth definite goals during the term of the Contract.

Transactions of \$50,000 or More:

If Contractor has fifty or more employees and a Contract for \$50,000 or more, it shall develop and submit to Owner, within thirty days after award, a written affirmative action compliance program providing in detail specific steps to guarantee equal employment opportunity. Contractor shall include in its affirmative action program a table of job classifications, which table shall include but need not be limited to job titles, duties, and rates of pay.

Contractor shall in each subcontract let to do a portion of the work covered hereunder, where the subcontractor involved has fifty or more employees and the subcontract is for \$50,000 or more, impose in the subcontract the above requirements.

For the purpose of determining the number of employees, the average of the Contractor's or its subcontractor's employees for the twelve month period immediately prior to award, or the total number of employees the Contractor or its subcontractor will have when performing this contract, whichever is higher, shall be used.

Federal Assisted Construction:

If this project is a Federally assisted construction project, then the contract provisions contained in 41 CFR SS 60-1.04 (b) are incorporated herein and the Contractor shall likewise incorporate said provisions in each subcontract entered by Contractor to perform the work. Federally assisted construction is identified as such in the Notice Inviting Bids.

SS 20. DEPOSIT OF SECURITIES:

In accordance with Public Contract Code Section 22300 and other applicable law, the Contractor may substitute securities for any moneys withheld to ensure performance under the contract.

SS 21. ASSIGNMENT OF CLAIMS:

In submitting a bid on this public works project, or any subcontractor agreeing to supply goods, services, or materials, and entering a contract pursuant thereto, the Contractor and/or subcontractor do offer and agree to assign to the Owner all rights, title, and interest in and to all causes of action it may have under Section 4 of the Clayton Act (15 U.S.C. Section 15) or under the Cartwright Act (Chapter 2 (commencing with Section 16700) of Part 2 of Division 7 of the Business and Professions Code), arising from purchases of goods, services, or materials pursuant to the public works contract or the subcontract. This assignment shall be made and become effective at the time the awarding body tenders final payment to the Contractor, without further acknowledgement by the parties.

SS 22. CLAIMS RESOLUTION:

In accordance with Public Contract Code Section 20104 - 20104.8 and other applicable law, public works claims of \$375,000 or less which arise between the Contractor and the Owner shall be resolved following the statutory procedure unless the Owner has elected to resolve the dispute pursuant to Public Contract Code SS 10240 et seq.

1. All claims shall be submitted in writing and accompanied by substantiating documentation. Claims must be filed on or before the date of final payment unless other notice requirements are provide in the contract. "Claim" means a separate demand by the claimant for (1) a time extension, (2) payment of money or damages arising from work done by or on behalf of the claimant and payment of which is not otherwise expressly provided for or the claimant is not otherwise entitled, or (3) an amount the payment of which is disputed by the Owner.

(a) Claims Under or equal to \$50,000. The Owner shall respond in writing to the claim within 45 days of receipt of the claim, or, the Owner may request, in writing, within 30 days of receipt of the claim, any additional documentation supporting the claim or relating to defenses or claims the Owner may have. If additional information is needed thereafter, it shall be provided upon mutual agreement of the Owner and the claimant. The Owner's written response shall be submitted 15 days after receiving the additional documentation, or within the same period of time taken by the claimant to produce the additional information, whichever is greater.

- (b) Claims over \$50,000 but less than or equal to \$375,000. The Owner shall respond in writing within 60 days of receipt, or, may request in writing within 30 days of receipt of the claim, any additional documents supporting the claim or relating to defenses or claims the Owner may have against the claimant. If additional information is needed thereafter, it shall be provided pursuant to mutual agreement between the Owner and the claimant. The Owner's response shall be submitted within 30 days after receipt of the further documents, or within the same period of time taken by the claimant to produce the additional information or documents, whichever is greater.
2. If the claimant disputes the Owner's response, or if the Owner fails to respond within the statutory time period, the claimant may so notify the Owner within 15 days of the receipt of the response or the failure to respond, and demand an informal conference to meet and confer for settlement. Upon such demand, the Owner shall schedule a meet and confer conference within 30 days.
 3. If following the meet and confer conference, the claim or any portion thereof remains in dispute, the claimant may file a claim pursuant to Government Code SS 900 et seq. and Government Code SS 910 et seq. For purposes of those provisions, the time within which a claim must be filed shall be tolled from the time the claimant submits the written claim until the time the claim is denied, including any time utilized for the meet and confer conference.
 4. If a civil action is filed to resolve any claim, the provisions of Public Contract Code SS 20104.4 shall be followed, providing for non-binding mediation and judicial arbitration.

SS 23. DUST ABATEMENT:

Dust control shall conform to Section 10, "Dust Control", Section 7-1.01F, "Air Pollution Control", Section 17, "Watering", and Section 18, "Dust Palliative" of the Standard Specifications, Rules no. 401, 402, 403 and 403.1 of the South Coast Air Quality Management District (AQMD), Riverside County Code, Chapter 8.52, "Fugitive Dust Reduction Program For Coachella Valley", all other applicable Federal and State laws, and the requirements set forth herein.

The Contractor is cautioned that failure to control fugitive dust may result in fines being levied by the South Coast Air Quality Management District to both the Contractor and the County of Riverside, as owner. The Contractor shall be fully responsible for payment of all fines pertaining to air pollution control violations, resulting from Contractor's operations related to the construction contract, which may be levied against both the Contractor and the County of Riverside by the AQMD or other regulatory agencies. The Contractor's attention is directed to Section 7-1.01, "Laws to be Observed" of the Standard Specifications. The cost of all fines levied against the County of Riverside will be deducted from any moneys due or which may become due to the Contractor, unless other payment arrangements are made by the Contractor.

Dust control of all of the Contractor's operations is required 24 hours per day, 7 days a week for the duration of the contract, and until the disturbed soil is permanently stabilized. The Contractor shall take every precaution to prevent emissions of fugitive dust from the project site, from locations of stockpiled materials, from unpaved driving surfaces, from haul vehicles, from inactive construction areas, and from all other operations of the Contractor. The Contractor shall plan for and carry out proper and efficient measures to prevent his operations from producing dust in amounts damaging to property or which constitute a public nuisance, or which cause harm to persons living or working in the vicinity of the work. Of particular concern are emissions of PM10 particles, which are fine particulate matter of 10 microns or less and which are associated with sickness and death from respiratory disease.

The Contractor shall furnish and post dust mitigation signs, which shall be, at a minimum, in accordance with the "AQMD Signage Recommendations", attached hereto. Additional copies are available upon request from the Engineer. The sign shall include the Contractor's phone number which shall be maintained on a 24 hour basis. The sign message, size and design, including any deviations from the signage recommendations, shall be approved by the Engineer prior to fabrication.

The Contractor shall respond to complaints by mobilizing equipment and personnel at the construction site within 2 hours of each complaint to control fugitive dust.

Attention is directed to AQMD Rule 403.1, which applies to all contracts within the Coachella Valley Area of Riverside County. That AQMD Rule requires the Contractor to take specified dust control actions when prevailing wind speeds exceed 25 miles per hour. Wind forecasts, AQMD Rules and

other related information are provided by AQMD at 1-800-CUT-SMOG and at www.aqmd.gov.

Any days on which the Contractor is prevented from working, due to the requirements of AQMD Rules, will be considered as non-working days, in accordance with Section 8-1.06, "Time of Completion" of the Standard Specifications.

The Contractor shall utilize the "Best Available Control Measures" of controlling fugitive dust, as prepared by the AQMD. For projects within the Coachella Valley, the "Reasonably Available Control Measures" may be employed, if effective within the context of the AQMD rules. However, if fugitive dust crosses the project boundary, more effective control measures, including the "Best Available Control Measures" shall be implemented.

A site-specific fugitive dust control plan shall be submitted to the Engineer for review and approval at least 10 days prior to the start of construction. Additionally, for projects outside of the Coachella Valley which meet the criteria for AQMD plan approval, the Contractor shall submit the dust control plan to AQMD for approval. AQMD plan submittal criteria is defined in AQMD Rule 403 as being for projects that will have disturbed surface area in excess of 100 acres, or for projects with a scope of work which requires the movement of more than 10,000 cubic yards of soil on each of any three working days.

A sample plan and other pertinent information is attached, and additional copies are available from the Engineer upon request. The fugitive dust control plan shall include the "Reasonably Available Control Measures" and "Best Available Control Measures" of controlling fugitive dust, as may be appropriate and necessary, including but not limited to watering, application of chemical dust suppressants, wind fencing, covering of haul vehicles, haul vehicle bed-liners, covering or chemically stabilizing stored materials, phased grading, planting of vegetation, the use of a 24 hour environmental observer, and track-out controls at locations where unpaved construction accesses intersect with paved roads. The use of chemical stabilizers, which are approved by all environmental regulatory agencies, and the use of reclaimed water is encouraged. If water is intended as a primary dust control tool, the dust control plan shall provide for at least one 2,000 gallon water truck for every 4 acres of disturbed soil, unless otherwise approved by the Engineer.

If the Construction Engineer determines that the project scope and the forecasted weather conditions are such that the Contractor's work is unlikely to be a source of dust emissions, the Construction Engineer has the authority to waive the requirements for submittal of a dust control plan

and for placement of the dust control signs described herein. However, the Contractors responsibilities for the control of fugitive dust and the other requirements of this section may not be waived.

A completion notice will not be filed, and the final payment will not be made to the Contractor until the areas of disturbed soil on the construction site, including roadway shoulders, are suitably stabilized for long term control of fugitive dust.

The successful Contractor shall attend an AQMD PM10 Dust Control Program training session, and furnish evidence of attendance to the Engineer. Attendance at AQMD training seminars can be scheduled through AQMD at 1-866-861-DUST (1-866-861-3878) or by email to dustcontrol@aqmd.gov. Current AQMD certification of previous attendance will be accepted.

At that training session, the successful Contractor will be furnished with the AQMD prepared Rule 403 and Rule 403.1 implementation handbooks, which include the "Best Available Control Measures" and "Reasonably Available Control Measures", and other associated information, including a listing of suggested dust control related devices, materials and chemicals.

The signature of the Contractor on the Proposal constitutes acknowledgement by the Contractor of the dust control requirements established by law and described herein, and the enforceability of those requirements.

When the contract includes a bid item for Dust Abatement, full compensation for conformance with these dust abatement requirements, including labor, equipment, materials, developing water supply and incidentals, shall be paid at the lump sum price for Dust Abatement, and no additional compensation will be allowed therefor.

When the contract does not include a bid item for Dust Abatement, full compensation for conformance with these dust abatement requirements, including labor, equipment, materials, developing water supply and incidentals, shall be considered as included in the various items of work, and no additional compensation will be allowed therefor.

AQMD RECOMMENDATIONS

November, 2001

Plan holder shall post signage at specified locations on the subject property in accordance with the standards specified below. The exception to the standards is that all letters shall be 4 inches high, with the names and telephone numbers of appropriate contacts and services in bold print, as indicated in the standards. These signs shall also include the SCAQMD toll free complaint line 1-800-CUT-SMOG (1-800-288-7664) and the telephone number for the Environmental Observer. These signs shall be posted within 50 feet of the curb on all four (4) corners of the subject property.

For each Dust Control Plan aggregating less than, or equal to, ten (10) acres:

1. The applicant shall install a sign on such property which is visible to the public that meets the following requirements:
 - (a) Such sign shall measure at least four (4) feet wide by four (4) feet high and conform to the specifications in 1 (a) below.

For each Dust Control Plan aggregating over ten (10) acres:

2. The applicant shall install a sign on such property which is visible to the public that meets the following requirements:
 - (a) Such sign shall measure at least eight (8) feet wide by four (4) feet high and conform to the specifications in 1 (b) below.

THE SIGN SHALL CONFORM TO THE FOLLOWING REQUIREMENTS:

1. **The sign boards shall be constructed with materials capable of withstanding the environment in which they are placed.**
 - (a) For 4' x 4' signs, the District recommends the following:
 - I. ¾" A/C laminated plywood board
 - II. Two 4" x 4" posts
 - III. The posts should be attached to the edges of the plywood board with at least 2 carriage bolts on each post.
 - IV. The front surface of the sign board should be painted in the contrasting color of a white background with black lettering.
 - (b) For 4' x 8' signs, the District recommends the following:
 - I. 1" A/C laminated plywood board
 - II. Two 5" x 6" posts
 - III. The posts should be attached to the 4' edges of the plywood board with at least 2 carriage bolts on each post.
 - IV. The front surface of the sign board should be painted in the contrasting color of a white background with black lettering.

2. The sign board shall be installed and maintained in a condition such that members of the public can easily view, access, and read the sign at all times until the expiration date of the Dust Control plan.

(a) For 4' x 4' signs, the District recommends the following:

- I. The lower edge of the sign board should be mounted at least 2' above the existing ground surface to facilitate ease of viewing.
- II. The posts should be set in a hole at least 3' deep with concrete footings to preclude downing by high winds.
- III. On the construction site, the sign should be positioned such that nothing obstructs the public's view from the primary street access point.
- IV. For construction projects that are developed in phases, the sign should be moved to the area that is under active construction.
- V. In situations where all phases of the construction project are completed on a property prior to expiration of the Dust Control Plan, a written request for cancellation of the Dust Control Plan must be submitted to the Engineer.

(b) For 4' x 8' signs, the District recommends the following:

- I. The lower edge of the sign board should be mounted at least 2' above the existing ground surface to facilitate ease of viewing.
- II. The posts should be set in a hole at least 4' deep with concrete footings to preclude downing by high winds.
- III. On the construction site, the sign should be positioned such that nothing obstructs the public's view from the primary street access point.
- IV. For construction projects that are developed in phases, the sign should be moved to the area that is under active construction.
- V. In situations where all phases of the construction project are completed on a property prior to expiration of the Dust Control Plan, a written request for cancellation of the Dust Control Plan must be submitted to the Engineer.

3. The sign board shall contain the following information:

- (a) Project Name
- (b) Name of Prime Contractor
- (c) Phone Number of Contractor's Employee Responsible for Dust Control Matters
- (d) County designated phone number (to be provided by the Engineer)
- (e) South Coast Air Quality Management District Phone Number

4. The sign board shall be designed to the following alpha and numeric text dimensions (sign boards written in longhand are unacceptable).

(a) For a permittee subject to the 4' x 4' sign requirement, the District provides the following example: (as modified by the County of Riverside for use on County Public Works projects)

1" UPPERCASE Letters →	PROJECT NAME:		3 ½ " Title Case Bold Letters ←
1" UPPERCASE Letters →	CONTRACTOR		3 ½ " Title Case Bold Letters ←
1" Title Case Letters →	Contractor's Dust Control Phone #		3" Bold Numbers ←
1" Title Case Letters →	County of Riverside Phone #		3" Bold Numbers ←
1" Title Case Letters →	Phone Number:	SCAQMD 1-800-CUT-SMOG	3 ½ " Bold Numbers ←

"Title Case" means the first letter of a word is capitalized and subsequent letters are lower case.

(b) For a permittee subject to the 4' x 8' sign requirement, the District provides the following example: (as modified by the County of Riverside)

2" UPPERCASE Letters	PROJECT NAME:	4" Title Case Bold Letters
2" UPPERCASE Letters	CONTRACTOR	4" Title Case Bold Letters
2" Title Case Letters	Contractor's Dust Control Phone #	4" Bold Numbers
2" Title Case Letters	County of Riverside Phone #	4" Bold Numbers
2" Title Case Letters	Phone Number:	4 1/2" Bold Numbers
2" Title Case Letters	SCAQMD 1-800-CUT-SMOG	
	COUNTY OF RIVERSIDE TRANSPORTATION DEPARTMENT	

Section 1

Simplified Sample Site Plan

Existing Residential

Distance and location of nearest:

Residence _____

Business _____

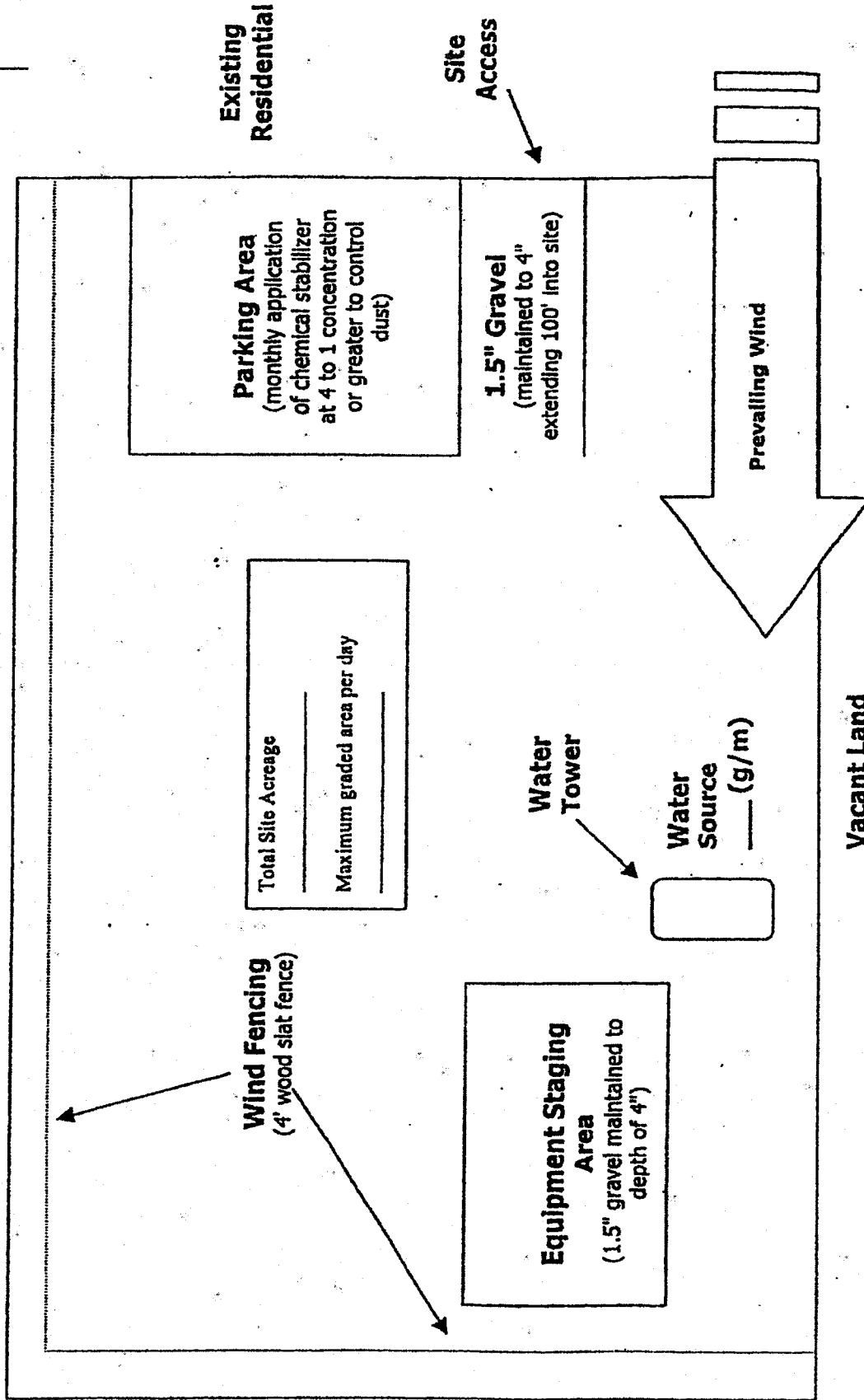
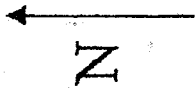

Existing Residential

Remember...
DUST CONTROL IS REQUIRED 24 HOURS A DAY, 7 DAYS A WEEK, REGARDLESS OF CONSTRUCTION STATUS

Plan Review Checklist Clearing/Grubbing/Mass Grading Phase

If feasible, use grading permit conditions to break the project into phases so that only a portion of the site is disturbed at any given time to ensure control of fugitive dust. This technique is critical for project sites with greater than 100 acres.

Prior to initiating activity, pre-water site through use of portable irrigation lines. At least 72 hours of pre-watering is recommended for each area prior to initiating earth-movement. Require the Applicant to specify water source and available flow rate (g/m).

Water applied continuously to all disturbed portions of the site by means of water truck/water pull as necessary to maintain sufficient visible moisture on the soil surface. For reference, one 2,000 gallon water truck can treat approximately 4 acres of active construction per hour. Also, for cut and fill activities, one 10,000 gallon water pull is estimated to be necessary for each 7,000 cubic yards of daily earth-movement. Multiple 4,000-gallon water trucks may be used in place of one 10,000-gallon water pull. Touch and visual contrast are reasonably good indicators of soil moisture. Surface areas that are dry to the touch and appear lighter-colored require the application of additional water to prevent visible or fugitive dust. Require the Applicant to specify the number of watering vehicles available for dust control during mass grading and during off-hours as well as availability of back-up water trucks if the site experiences dust control problems.

Water towers are necessary for projects with more than 10 acres of active construction. Without a water tower, it can take up to 30 minutes to fill a 2,000 gallon water truck. Also, multiple water towers are necessary for projects that use water pulls as filling one 10,000 gallon water pull can drain a water tower which takes up to 40 minutes to refill.

Wind fencing is necessary between the site and nearby residences or businesses. Off-site upwind fencing and on-site wind fencing for larger projects can also keep blowsand from being deposited onto the site or traveling through the site.

A perimeter watering system consisting of portable irrigation equipment may be an effective mitigation system to protect surrounding residences and businesses. The portable watering system may be used in place of or in conjunction with watering trucks. The local jurisdiction may also be provided access to this equipment.

Remember...

**DUST CONTROL IS REQUIRED 24 HOURS A DAY, 7 DAYS A WEEK,
REGARDLESS OF CONSTRUCTION STATUS**

- Construction site accesses are to be improved with 1.5" gravel maintained to a depth of 4" , at least 20' wide, and extending 100 feet into the site. If the project site is not balanced, a wheel washing system and/or ribbed steel plates should be placed in the roadway before the vehicle enters the graveled area to clean the tires and prevent trackout.
- Equipment staging areas are to be treated with 1.5" gravel maintained to a depth of 4".
- Employee parking areas are to be covered with 1.5" gravel maintained to a depth of 4" or treated with chemical dust suppressants at a 4 to 1 ratio on at least a monthly basis to prevent fugitive dust.
- Chemical dust suppressants are to be mixed at a ratio of 20 to 1 and applied to all disturbed surfaces that are proposed to remain inactive for a period of at least 10 consecutive days. These products are effective in preventing and controlling dust. Recordkeeping is necessary to demonstrate compliance.
- All project sites greater than 100 acres shall monitor daily wind speeds and AQMD forecasted wind events (call 1.800.CUT.SMOG; press one for air quality information, and then press five for Coachella Valley wind forecasts). Operators shall maintain these records for review by any local code enforcement officer or AQMD inspector.
- An environmental observer whose primary duty is to oversee dust control at the site is to be used for construction projects greater than 100 acres and/or sites with more than 50 acres of active construction. The environmental observer is tasked with monitoring dust abatement measures and authorized to deploy additional water trucks and other dust control actions (i.e., wind fencing, street sweepers, chemical dust suppressants, etc.) as necessary to prevent or control fugitive dust.
- Other (specify): _____

Remember...
DUST CONTROL IS REQUIRED 24 HOURS A DAY, 7 DAYS A WEEK,
REGARDLESS OF CONSTRUCTION STATUS

Plan Review Checklist Finish Grading Phase

- Water applied continuously to all disturbed portions of the site by means of water truck/water pull as necessary to maintain sufficient visible moisture on the soil surface. For reference, one 2,000 gallon water truck can treat approximately 4 acres of active construction per hour. Also, for cut and fill activities, one 10,000 gallon water pull is estimated to be necessary for each 7,000 cubic yards of daily earth-movement. Multiple 4,000-gallon water trucks may be used in place of a 10,000-gallon water pull. Touch and visual contrast are reasonably good indicators of soil moisture. Surface areas that are dry to the touch and appear lighter-colored require the application of additional water to prevent visible or fugitive dust. Require the Applicant to specify the number of watering vehicles available for dust control during finish grading and during off-hours as well as availability of back-up water trucks if the site experiences dust control problems.

- Water towers are necessary for projects with more than 10 acres of active construction. Without a water tower, it can take up to 30 minutes to fill a 2,000 gallon water truck. Also, multiple water towers are necessary for projects that use water pulls as filling one 10,000 gallon water pull can drain a water tower which takes up to 40 minutes to refill.

- Wind fencing is necessary between the site and nearby residences or businesses to reduce fugitive dust. Off-site upwind fencing and on-site wind fencing for larger projects can also keep blowsand from being deposited onto the site or traveling through a site.

- Chemical dust suppressants are to be applied at a concentration of at least 10 to 1 to finish graded areas once final elevations have been reached. For areas that will remain inactive for longer periods, vegetation can be a cost-effective alternative to chemical stabilization. Wind fencing or other obstructions can keep the stabilized area free from future disturbances.

- Construction site access(es) are to be improved with 1.5" gravel maintained to a depth of at least 4" with a minimum width of at least 20', extending 100 feet into the project site.

- Equipment staging areas are to be treated with 1.5" gravel maintained to a depth of 4".

- Internal roadway networks are to be treated with chemical dust suppressants at a minimum rate of at least 4 to 1 and retreated on a monthly basis once final roadway elevations have been reached.

- Employee parking areas are to be treated with chemical dust suppressants at a mix ratio of at least 4 to 1 and retreated on at least a monthly basis or covered with 1.5" gravel maintained to a depth of 4" to prevent fugitive dust.

- Other (specify): _____

Remember...
DUST CONTROL IS REQUIRED 24 HOURS A DAY, 7 DAYS A WEEK,
REGARDLESS OF CONSTRUCTION STATUS

Plan Review Checklist Construction Phase

- Water applied continuously to all disturbed portions of the site by means of water truck/water pull is necessary to maintain sufficient visible moisture on the soil surface. For reference, one 2,000 gallon water truck can treat approximately 4 acres of active construction per hour. Touch and visual contrast are reasonably good indicators of soil moisture. Surface areas that are dry to the touch and appear lighter-colored require the application of additional water to prevent visible or fugitive dust. Require the Applicant to specify the number of watering vehicles available for dust control during the construction phase and during off-hours as well as availability of back-up water trucks if the site experiences dust control problems.

- Wind fencing is necessary between the site and nearby residences or businesses. Off-site upwind fencing and on-site wind fencing for larger projects can also keep blowsand from being deposited onto the site or traveling through the site. Block walls, if part of the final project, can replace wind fencing during the construction phase.

- Chemical dust suppressants are to be applied at a concentration of at least 20 to 1 to finish graded areas once final elevations have been reached. For areas that will remain inactive for longer periods, vegetation can be a cost-effective alternative to chemical stabilization. Wind fencing or other obstructions can keep the stabilized area free from future disturbances.

- Construction site accesses are to be improved with 1.5" gravel, maintained to a depth of 4", with a width of at least 20', extending 100' into the project site. Paving internal roadways can substitute for gravel.

- Internal roadway networks are to be paved as early as feasible in the construction phase. Street sweeping of internal and/or external access roads will likely be required to control entrained road dust.

- Employee parking areas are to be treated with chemical dust suppressants at a mix ratio of no less than 4 to 1 and retreated on a monthly basis, or more frequently if fugitive dust is observed. If internal roadway is complete, employees are to be instructed to park on paved roads.

- Other (specify): _____

Remember...
DUST CONTROL IS REQUIRED 24 HOURS A DAY, 7 DAYS A WEEK,
REGARDLESS OF CONSTRUCTION STATUS

RULE 403 IMPLEMENTATION HANDBOOK

REASONABLY AVAILABLE CONTROL MEASURES

Paragraph (d)(3) of Rule 403 allows activities outside the South Coast Air Basin (see Figure 2-1) to implement reasonably available control measures in lieu of best available control measures. Additionally, as specified by subparagraph (f)(3)(D) of Rule 403, any person seeking approval of a fugitive dust emissions control plan for projects outside the South Coast Air Basin must demonstrate to the satisfaction of the District that the given activity is employing all reasonably available fugitive dust control measures.

The District has prepared the attached listing of reasonably available fugitive dust control measures for a variety of source categories. This list is based on the U.S. Environmental Protection Agency's reference document entitled, "Control of Open Fugitive Dust Sources," Midwest Research Institute, September 1988.

The District encourages the use of those dust control measures that minimize the use of potable water. When water is needed, reclaimed water should be utilized to the greatest extent feasible.

REASONABLY AVAILABLE CONTROL MEASURES

The left column contains a listing of the sources of fugitive dust which are intended for emission control under District Rule 403 and a listing of control measures and high-wind measures. The right column contains a description of the reasonably available fugitive dust control measures for each of the sources.

Source: (1) Land Clearing/Earth-Moving

CONTROL MEASURES

DESCRIPTION

- (A) Watering
 - (1) Application of water by means of trucks, hoses and/or sprinklers prior to conducting any land clearing. This will increase the moisture content of the soils; thereby increasing its stability.
 - (2) Pre-application of water to depths of proposed cuts.
 - (3) Once the land clearing/earth moving activities are complete, a second application of water can generate a thin crust that stabilizes the disturbed surface area provided that it is not disturbed. (Security fencing can be used to prevent unwanted future disturbances of sites where a surface crust has been created).

- (B) Chemical stabilizers
 - (1) Only effective in areas which are not subject to daily disturbances.
 - (2) Vendors can supply information on product application and required concentrations to meet the specifications established by the Rule.

- (C) Wind fencing
 - (1) Three- to five-foot barriers with 50% or less porosity located adjacent to roadways or urban areas can be effective in reducing the amount of windblown material leaving a site.
 - (2) Would likely be used in conjunction with other measures (e.g., watering, chemical stabilization, etc.) to ensure that visible emissions do not cross a property line.

- (D) Cover haul vehicles
 - (1) Entire surface area of hauled earth should be covered once vehicle is full.

- (E) Bedliners in haul vehicles
 - (1) When feasible, use in bottom-dumping haul vehicles.

HIGH WIND MEASURE

- (a) Cease all active operations; or
- (b) Apply water within 15 minutes to any soil surface which is being moved or otherwise disturbed.

Source: (2) Unpaved Roads

CONTROL MEASURES

DESCRIPTION

- | | |
|----------------------------|---|
| (F) Paving | (1) Requires street sweeping/cleaning if subject to material accumulation. |
| (G) Chemical stabilization | (1) Vendors can supply information as to application methods and concentrations to meet the specifications established by the Rule
(2) Not recommended for high volume or heavy equipment traffic use. |
| (H) Watering | (1) In sufficient quantities to keep surface moist.
(2) Required application frequency will vary according to soil type, weather conditions, and vehicular use. |
| (I) Reduce speed limits | (1) 15 mile per hour maximum. May need to be used in conjunction with watering or chemical stabilization to prevent visible emissions from crossing the property line. |
| (J) Reduce vehicular trips | (1) Access restriction or redirecting traffic to reduce vehicle trips by a minimum of 60 percent. |
| (K) Gravel | (1) Gravel maintained to a depth of four inches can be an effective measure.
(2) Should only be used in areas where paving, chemical stabilization or frequent watering is not feasible. |

HIGH WIND MEASURE

- (c) Apply a chemical stabilizer (to meet the specifications established by the Rule) prior to wind events; or
- (d) Apply water once each hour; or
- (e) Stop all vehicular traffic.

RULE 403 IMPLEMENTATION HANDBOOK

Source: (3) Storage Piles

CONTROL MEASURES

DESCRIPTION

- | | |
|--|--|
| (L) Wind sheltering | (1) Enclose in silos.
(2) Install three-sided barriers equal to height of material, with no more than 50 percent porosity. |
| (M) Watering | (1) Application methods include: spray bars, hoses and water trucks.
(2) Frequency of application will vary on site-specific conditions. |
| (N) Chemical stabilizers | (1) Best for use on storage piles subject to infrequent disturbances. |
| (O) Altering load-in/load-out procedures | (1) Confine load-in/load-out procedures to leeward (downwind) side of the material.
(2) May need to be used in conjunction with wind sheltering to prevent visible emissions from crossing the property line. |
| (P) Coverings | (1) Tarps, plastic, or other material can be used as a temporary covering.
(2) When used, these should be anchored to prevent wind from removing coverings. |

HIGH WIND MEASURE

- (f) Apply chemical stabilizers (to meet the specifications established by the Rule) prior to wind events; or
- (g) Apply water once per hour; or
- (h) Install temporary covers.

Source: (4) Paved Road Track-Out

CONTROL MEASURES

DESCRIPTION

- | | |
|--------------------------------|--|
| (Q) Chemical stabilization | (1) Most effective when used on areas where active operations have ceased.
(2) Vendors can supply information on methods for application and required concentrations. |
| (R) Sweep/clean roadways | (1) Either sweeping or water flushing may be used. |
| (S) Cover haul vehicles | (1) Entire surface area should be covered once vehicle is full. |
| (T) Bedliners in haul vehicles | (1) When feasible, use in bottom dumping vehicles. |
| (U) Site access improvement | (1) Pave internal roadway system.
(2) Most important segment, last 100 yards from the connection with paved public roads |

HIGH WIND MEASURE

- (i) Cover all haul vehicles; and
- (ii) Clean streets with water flushing, unless prohibited by the Regional Water Quality Control Board.

RULE 403 IMPLEMENTATION HANDBOOK

Source: (5) Disturbed Surface Areas/ Inactive Construction Sites

CONTROL MEASURES

DESCRIPTION

- | | |
|----------------------------|---|
| (Q) Chemical stabilization | (1) Most effective when used on areas where active operations have ceased. |
| | (2) Vendors can supply information on methods for application and required concentrations. |
| (R) Watering | (1) Requires frequent applications unless a surface crust can be developed. |
| (S) Wind fencing | (1) Three- to five-foot barriers with 50% or less porosity adjacent to roadways or urban areas can be effective in reducing the amount of wind blown material leaving a site. |
| (T) Vegetation | (1) Establish as quickly as possible when active operations have ceased.
(2) Use of drought tolerant, native vegetation is encouraged. |

HIGH WIND MEASURES

- (k) Apply chemical stabilizers (to meet the specifications established by the Rule); or
(l) Apply water to all disturbed surface areas 3 times per day.

BEST AVAILABLE CONTROL MEASURES

Rule 403, paragraph (d)(2) requires active operations [defined in Rule 403, paragraph (c)(1)] within the South Coast Air Basin (see Figure 2-1) to implement at least one best available control measure for each fugitive dust source type on site. Additionally, as specified by subparagraph (f)(3)(D) of Rule 403, any person seeking approval of a fugitive dust emissions control plan for projects within the South Coast Air Basin must demonstrate to the satisfaction of the AQMD that the given activity is employing all best available fugitive dust control measures.

The AQMD has prepared the attached listing of best available fugitive dust control measures for a variety of source categories. This list is based on the U.S. Environmental Protection Agency's reference document entitled, "Fugitive Dust Background Document and Technical Information Document for Best Available Control Measures," Office of Air and Radiation, September 1992.

The AQMD encourages the use of those dust control measures that minimize the use of potable water. When water is needed, reclaimed water should be utilized to the greatest extent feasible.

RULE 403 IMPLEMENTATION HANDBOOK

BEST AVAILABLE CONTROL MEASURES

The left column contains a listing of the sources of fugitive dust which are intended for emission control under District Rule 403 and a listing of control measures and high-wind measures. The right column contains a description of the best available fugitive dust control measures for each of the sources.

Source: (1) Land Clearing/Earth-Moving

CONTROL MEASURES

DESCRIPTION

- | | |
|--------------------------------|---|
| (A) Watering (pre-grading) | (1) Application of water by means of trucks, hoses and/or sprinklers prior to conducting any land clearing. This will increase the moisture content of the soils; thereby increasing its stability. |
| (A-1) Watering (post-grading) | (2) Pre-application of water to depths of proposed cuts. |
| (A-2) Pre-grading planning | (1) In active earth-moving areas water should be applied at sufficient frequency and quantity to prevent visible emissions from extending more than 100 feet from the point of origin. |
| (B) Chemical stabilizers | (1) Grade each phase separately, timed to coincide with construction phase; or
(2) Grade entire project, but apply chemical stabilizers or ground cover to graded areas where construction phase begins more than 60 days after grading phase ends. |
| (C) Wind fencing | (1) Only effective in areas which are not subject to daily disturbances.
(2) Vendors can supply information on product application and required concentrations to meet the specifications established by the Rule. |
| (D) Cover haul vehicles | (1) Three- to five-foot barriers with 50% or less porosity located adjacent to roadways or urban areas can be effective in reducing the amount of windblown material leaving a site. Must be implemented in conjunction with either measure (A-1) or (B). |
| (E) Bedliners in haul vehicles | (1) Entire surface area of hauled earth should be covered once vehicle is full.
(1) When-feasible, use in bottom-dumping haul vehicles. |

HIGH WIND MEASURE

- (a) Cease all active operations; or
- (b) Apply water within 15 minutes to any soil surface which is being moved or otherwise disturbed.

RULE 403 IMPLEMENTATION HANDBOOK

Source: (2) Unpaved Roads

CONTROL MEASURES

DESCRIPTION

- | | |
|----------------------------|---|
| (F) Paving | (1) Requires street sweeping/cleaning if subject to material accumulation. |
| (G) Chemical stabilization | (1) Vendors can supply information as to application methods and concentrations to meet the specifications established by the Rule
(2) Not recommended for high volume or heavy equipment traffic use. |
| (H) Watering | (1) In sufficient quantities to keep surface moist.
(2) Required application frequency will vary according to soil type, weather conditions, and vehicular use. |
| (I) Reduce speed limits | (1) 15 mile per hour maximum. May need to be used in conjunction with watering or chemical stabilization to prevent visible emissions from crossing the property line. |
| (J) Reduce vehicular trips | (1) Access restriction or redirecting traffic to reduce vehicle trips by a minimum of 60 percent. |
| (K) Gravel | (1) Gravel maintained to a depth of four inches can be an effective measure.
(2) Should only be used in areas where paving, chemical stabilization or frequent watering is not feasible. |

HIGH WIND MEASURE

- (a) Apply a chemical stabilizer (to meet the specifications established by the Rule) prior to wind events; or
- (b) Apply water once each hour; or
- (c) Stop all vehicular traffic.

RULE 403 IMPLEMENTATION HANDBOOK

Source: (3) Storage Piles

CONTROL MEASURES

(L) Wind sheltering

DESCRIPTION

- (1) Enclose in silos.
- (2) Install three-sided barriers equal to height of material, with no more than 50 percent porosity.

(M) Watering

- (1) Application methods include: spray bars, hoses and water trucks.
- (2) Frequency of application will vary on site-specific conditions.

(N) Chemical stabilizers

- (1) Best for use on storage piles subject to infrequent disturbances.

(O) Altering load-in/load-out procedures

- (1) Confine load-in/load-out procedures to leeward (downwind) side of the material.
Must be used in conjunction with either measure (L), (M), (N), or (P).

(P) Coverings

- (1) Tarps, plastic, or other material can be used as a temporary covering.
- (2) When used, these should be anchored to prevent wind from removing coverings.

HIGH WIND MEASURE

- (a) Apply chemical stabilizers (to meet the specifications established by the Rule) prior to wind events, or
- (b) Apply water once per hour; or
- (c) Install temporary covers.

RULE 403 IMPLEMENTATION HANDBOOK

Source: (4) Paved Road Track-Out

CONTROL MEASURES

DESCRIPTION

Compliance with District Rule 403.

Paragraph (d)(5).

RULE 403 IMPLEMENTATION HANDBOOK

Source: (S) Disturbed Surface Areas/ Inactive Construction Sites

CONTROL MEASURES

DESCRIPTION

- (Q) Chemical stabilization
 - (1) Most effective when used on areas where active operations have ceased.
 - (2) Vendors can supply information on methods for application and required concentrations.
- (R) Watering
 - (1) Requires frequent applications unless a surface crust can be developed.
- (S) Wind fencing
 - (1) Three- to five-foot barriers with 50% or less porosity adjacent to roadways or urban areas can be effective in reducing the amount of wind blown material leaving a site. Must be used in conjunction with either measure (Q), (R), or (T).
- (T) Vegetation
 - (1) Establish as quickly as possible when active operations have ceased.*

HIGH WIND MEASURES

- (a) Apply chemical stabilizers (to meet the specifications established by the Rule); or
- (b) Apply water to all disturbed surface areas 3 times per day.

* Use of drought tolerant, native vegetation is encouraged.

TABLE 1

BEST [REASONABLY]* AVAILABLE CONTROL MEASURES FOR HIGH WIND CONDITIONS

FUGITIVE DUST SOURCE CATEGORY	<u>CONTROL MEASURES</u>
Earth-moving	(1A) Cease all active operations; OR (2A) Apply water to soil not more than 15 minutes prior to moving such soil.
Disturbed surface areas	(0B) On the last day of active operations prior to a weekend, holiday, or any other period when active operations will not occur for not more than four consecutive days: apply water with a mixture of chemical stabilizer diluted to not less than 1/20 of the concentration required to maintain a stabilized surface for a period of six months; OR (1B) Apply chemical stabilizers prior to wind event; OR (2B) Apply water to all unstabilized disturbed areas 3 times per day. If there is any evidence of wind driven fugitive dust, watering frequency is increased to a minimum of four times per day; OR (3B) Take the actions specified in Table 2, Item (3c); OR (4B) Utilize any combination of control actions (1B), (2B), and (3B) such that, in total, these actions apply to all disturbed surface areas.
Unpaved roads	(1C) Apply chemical stabilizers prior to wind event; OR (2C) Apply water twice [once] per hour during active operation; OR (3C) Stop all vehicular traffic.
Open storage piles	(1D) Apply water twice [once] per hour; OR (2D) Install temporary coverings.
Paved road track-out	(1E) Cover all haul vehicles; OR (2E) Comply with the vehicle freeboard requirements of Section 23114 of the California Vehicle Code for both public and private roads.
All Categories	(1F) Any other control measures approved by the Executive Officer and the U.S. EPA as equivalent to the methods specified in Table 1 may be used.

* Measures in [brackets] are reasonably available control measures and only apply to sources not within the South Coast Air Basin.

January 1999

TABLE 2
DUST CONTROL ACTIONS FOR EXEMPTION FROM PARAGRAPH (d)(4)

<u>FUGITIVE DUST SOURCE CATEGORY</u>	<u>CONTROL ACTIONS</u>
Earth-moving (except construction cutting and filling areas, and mining operations)	<p>(1a) Maintain soil moisture content at a minimum of 12 percent, as determined by ASTM method D-2216, or other equivalent method approved by the Executive Officer, the California Air Resources Board, and the U.S. EPA. Two soil moisture evaluations must be conducted during the first three hours of active operations during a calendar day, and two such evaluations each subsequent four-hour period of active operations; OR</p> <p>(1a-1) For any earth-moving which is more than 100 feet from all property lines, conduct watering as necessary to prevent visible dust emissions from exceeding 100 feet in length in any direction.</p>
Earth-moving: Construction fill areas:	<p>(1b) Maintain soil moisture content at a minimum of 12 percent, as determined by ASTM method D-2216, or other equivalent method approved by the Executive Officer, the California Air Resources Board, and the U.S. EPA. For areas which have an optimum moisture content for compaction of less than 12 percent, as determined by ASTM Method 1557 or other equivalent method approved by the Executive Officer and the California Air Resources Board and the U.S. EPA, complete the compaction process as expeditiously as possible after achieving at least 70 percent of the optimum soil moisture content. Two soil moisture evaluations must be conducted during the first three hours of active operations during a calendar day, and two such evaluations during each subsequent four-hour period of active operations.</p>

* Measures in [brackets] are reasonably available control measures and only apply to sources not within the South Coast Air Basin.

January 1999

TABLE 2 (Continued)

FUGITIVE DUST SOURCE CATEGORY	CONTROL ACTIONS
Earth-moving: Construction cut areas and mining operations:	(1c) Conduct watering as necessary to prevent visible emissions from extending more than 100 feet beyond the active cut or mining area unless the area is inaccessible to watering vehicles due to slope conditions or other safety factors.
Disturbed surface areas (except completed grading areas)	(2a/b) Apply dust suppression in sufficient quantity and frequency to maintain a stabilized surface. Any areas which cannot be stabilized, as evidenced by wind driven fugitive dust must have an application of water at least twice per day to at least 80 [70] percent of the unstabilized area.
Disturbed surface areas: Completed grading areas	(2c) Apply chemical stabilizers within five working days of grading completion; OR (2d) Take actions (3a) or (3c) specified for inactive disturbed surface areas.
Inactive disturbed surface areas	(3a) Apply water to at least 80 [70] percent of all inactive disturbed surface areas on a daily basis when there is evidence of wind driven fugitive dust, excluding any areas which are inaccessible to watering vehicles due to excessive slope or other safety conditions; OR (3b) Apply dust suppressants in sufficient quantity and frequency to maintain a stabilized surface; OR (3c) Establish a vegetative ground cover within 21 [30] days after active operations have ceased. Ground cover must be of sufficient density to expose less than 30 percent of unstabilized ground within 90 days of planting, and at all times thereafter; OR (3d) Utilize any combination of control actions (3a), (3b), and (3c) such that, in total, these actions apply to all inactive disturbed surface areas.

* Measures in [brackets] are reasonably available control measures and only apply to sources not within the South Coast Air Basin.

January 1999

TABLE 2 (Continued)

<u>FUGITIVE DUST SOURCE CATEGORY</u>	<u>CONTROL ACTIONS</u>
Unpaved Roads	<p>(4a) Water all roads used for any vehicular traffic at least once per every two hours of active operations [3 times per normal 8 hour work day]; OR</p> <p>(4b) Water all roads used for any vehicular traffic once daily and restrict vehicle speeds to 15 miles per hour; OR</p> <p>(4c) Apply a chemical stabilizer to all unpaved road surfaces in sufficient quantity and frequency to maintain a stabilized surface.</p>
Open storage piles	<p>(5a) Apply chemical stabilizers; OR</p> <p>(5b) Apply water to at least 80 [70] percent of the surface area of all open storage piles on a daily basis when there is evidence of wind driven fugitive dust; OR</p> <p>(5c) Install temporary coverings; OR</p> <p>(5d) Install a three-sided enclosure with walls with no more than 50 percent porosity which extend, at a minimum, to the top of the pile.</p>
<u>All Categories</u>	<p>(6a) Any other control measures approved by the Executive Officer and the U.S. EPA as equivalent to the methods specified in Table 2 may be used.</p>

* Measures in [brackets] are reasonably available control measures and only apply to sources not within the South Coast Air Basin.

January 1999

TABLE 3
TRACK-OUT CONTROL OPTIONS
PARAGRAPH (d)(5)(B)

CONTROL OPTIONS

(1)	Pave or apply chemical stabilization at sufficient concentration and frequency to maintain a stabilized surface starting from the point of intersection with the public paved surface, and extending for a centerline distance of at least 100 feet and a width of at least 20 feet.
(2)	Pave from the point of intersection with the public paved road surface, and extending for a centerline distance of at least 25 feet and a width of at least 20 feet, and install a track-out control device immediately adjacent to the paved surface such that exiting vehicles do not travel on any unpaved road surface after passing through the track-out control device.
(3)	Any other control measures approved by the Executive Officer and the U.S. EPA as equivalent to the methods specified in Table 3 may be used.

January 1999

**ONTARIO AVENUE / TEMESCAL CANYON ROAD
AND
EL CERRITO ROAD / MINNESOTA ROAD**

**CONSTRUCTION OF TRAFFIC SIGNALS, PARKING LOT, AND
ASSOCIATED IMPROVEMENTS**

EL CERRITO COMMUNITY

PROJECT NO. B7-0767

SPECIAL PROVISIONS

DESCRIPTION:

In general, this project consists of installing traffic signals and constructing street improvements at the intersection of Ontario Avenue / Temescal Canyon Road and El Cerrito / Minnesota Road. The work involves reconstructing asphalt concrete pavement, constructing concrete curb ramps, driveway approaches, curb and gutter, raised median, stamped concrete, sidewalk, bus stop pad, bus turnout, paint traffic stripes, placing thermoplastic pavement markings, install reflective pavement markers, install roadside signs, and other associated work as may be required. The project also includes constructing asphalt concrete parking lot and installing onsite wastewater treatment system on private property.

SPECIFICATIONS:

This project shall conform to the requirements of the May 2006 edition of the Standard Specifications and Standard Plans as issued by the State of California Department of Transportation.

Amendments to May 2006 Standard Specifications, updated June 20, 2012, are incorporated herein and can be found on the County of Riverside website during the Bid Period.

http://www.rctlma.org/trans/con_bid_advertisements.html

SURVEY STAKING

County surveyors will establish external primary survey control marks and/or monuments to be used throughout the construction period. These control marks are to be protected by the contractor and will be used to set construction stakes. The control marks will also be used to make verification surveys at various stages of work.

Survey stakes and marks are set per the County's Survey Manual.

Contractor must submit a written request for County furnished construction staking before or once area to receive staking is ready for the installation of the construction stakes. The County will provide Contractor with a survey request form. Survey staking requests must be received from the Contractor a minimum of 2 business days prior to the installation of the requested construction staking. The County shall receive survey request from the contractor on normal business days, Monday through Thursday, 7:00 A.M. to 4:00 P.M. Requests received after 4:00 PM or on any day not previously noted, shall be considered as submitted at 7:00 AM the next business day.

A "business day" is defined by County Ordinance 358 (County Holidays, open and closed days, and hours of operation, etc.) and as revised by Board of Supervisor's resolution to alter days and/or hours for which a County office may be open for transaction of business. Note: Since August 13, 2009, the County has closed many facilities on Fridays.

Contractor must preserve primary and construction stakes and marks placed by the County. If the contractor fails to protect and/or destroys the primary and construction stakes and marks, the County shall replace them at the County's earliest convenience and deduct the cost of replacement from monies due the contractor.

DISPOSAL OF EXCESS EXCAVATION OR MATERIALS:

Excess earth excavation, pavement grindings and other excess materials resulting from construction operations shall be disposed of by the Contractor outside of the highway right of way, as provided in Section 7-1.13 of the Standard Specifications.

The second paragraph of Section 7-1.13 of the Standard Specifications is modified to read as follows:

When any material is to be disposed of outside the highway right of way, and the County of Riverside has not made arrangements for the disposal of such material, the Contractor shall first obtain written authorization from the property owner on whose property the disposal is to be made and he shall file with the Engineer said authorization or a certified copy thereof together with a written release from the property owner absolving the County of Riverside from any and all responsibility in connection with the disposal of material on said property. If the disposal of materials is to be made at an established disposal facility that is available for public use, the Contractor shall retain all authorizations and receipts from said disposal facility and shall provide copies to the Engineer upon request.

Full compensation for all costs involved in disposing of materials as specified in this section, including all costs of hauling, shall be considered as included in the various contract items of work and no additional compensation will be allowed therefor.

RECORD DRAWINGS:

The Contractor shall keep one clean set of bond originals to note any changes which take place during construction. These changes to the original plans and/or specifications shall be noted at the appropriate locations with the appropriate changes indicated in red pencil or ink. The Contractor shall note in large letters "RECORD DRAWINGS" on the Title Sheet of the plans. The job will not be

finalized by the Engineer until these record drawings have been completed to the satisfaction of the Engineer. The changes shall be noted on the plans as the changes occur. The record drawings shall be submitted to the Resident Engineer, and become the property of the County at conclusion of the project.

Full compensation for maintaining and compiling the record drawings shall be considered to be included in other items of work and no additional compensation will be allowed therefore.

COOPERATION:

Attention is directed to Section 7-1.14, "Cooperation" of the Standard Specifications and these Special Provisions.

The Contractor is hereby advised to cooperate with utility companies (AT&T and/or others) for adjusting water valves, manholes and other facilities to grade.

The Contractor is hereby advised to cooperate with property owners when working in front of their property.

Should construction be under way by other forces or by other Contractors within or adjacent to those limits, the Contractor shall cooperate with all the other Contractors or other forces to the end that any delay or hindrance to their work will be avoided. The right is reserved to perform other or additional work at or near the site (including material sources) at any time, by the use of other forces.

Utility work by Owners:

The Contractor's attention is directed to Section 8-1.10 "Utility and Non-Highway Facilities" of the Standard Specifications.

Working days allowed shall be in accordance with the executed agreement. The working days allowed shall include working days as required by the utility company for access to a portion of the construction site by the affected utility companies to perform utility relocation work, and work associated with the establishment of electrical service. The Utility company days are non-exclusive and are anticipated to not be sequential, and will be assigned by the Resident Engineer in coordination with the scheduling needs of the affected utility companies.

The utility relocation work that is anticipated to be performed during the course of construction is generally described as follows:

Inspection, cable installation, meter installation, and other work associated with the provision of electrical service.

Any and all utility relocation and protection work that may be required during construction. It is anticipated that the utility relocation and protection work to be performed by the Edison Company, AT&T, Time Warner Cable, EVMWD, SCG, the City of Corona and the Southern California Gas Company will be completed prior to the start of construction. However, the

Contractor shall cooperate with any utility forces that have a need to perform work within the project limits during the course of construction.

Full compensation for the provisions of this Special Provision shall be considered as included in the various items of work, and no additional compensation will be allowed therefore.

LIQUIDATED DAMAGES:

The Contractor shall diligently prosecute the work to completion before the expiration of 55 working days from the date stated in the "Notice to Proceed". The Contractor shall pay to the County of Riverside the sum of \$800.00 per day, for each and every calendar day's delay in finishing the work in excess of the number of working days prescribed above.

In addition to the liquidated damages set forth above, the Contractor shall pay to the County of Riverside the sum of \$400.00 per day for each and every calendar day's delay in receiving all of the below listed equipment, onto the job site or at the Contractor's storage facility, and available for installation, within 60 calendar days if standards/posts, anchor bolts and IISNS mast arms were furnished by the County; otherwise, 100 calendar days of the contract award:

1. Traffic Signal Controller Assemblies
2. Service Equipment Enclosures
3. Traffic Signal and Pedestrian Signal Heads
4. LED Modules
5. Edge-Lit LED Internally Illuminated Street Name Signs

PARTIAL PAYMENTS:

Attention is directed to Sections 9-1.06, "Partial Payments," and 9-1.07, "Payment After Acceptance," of the Standard Specifications and these Special Provisions.

For the purpose of making partial payments pursuant to Section 9-1.06, "Partial Payments," of the Standard Specifications, the amount set forth for the contract items of work hereinafter listed shall be deemed to be the maximum value of the contract items of work which will be recognized for progress payment purposes:

A.	Clearing and Grubbing	\$10,000
B.	Dust Abatement	\$ 1,000

After acceptance of the contract pursuant to the provisions in Section 7-1.17, "Acceptance of Contract," of the Standard Specifications, the amount, if any, payable for a contract item of work in excess of the maximum value for progress payment purposes hereinabove listed for the item, will be included for payment in the first estimate made after acceptance of the contract.

No partial payment will be made for any materials on hand which are furnished but not incorporated in the work.

CONSTRUCTION PROJECT FUNDING IDENTIFICATION SIGNS:

The Contractor shall furnish and install **One (1)** Construction Project Funding Identification Sign (4' X 8'); the sign shall be installed at locations to be determined by the Engineer, within or near the project limits, in accordance with the relevant requirements of Section 56-2 of the Standard Specifications and the appropriate details of Standard Plans RS1 through RS4 for two post installation of signs, and as directed by the Engineer.

A reference exhibit displaying the text and colors of the sign will be provided to the Contractor prior to construction.

The Contractor shall submit a copy of the final sign design for approval by the resident Engineer prior to fabrication.

The Contractor shall submit to the Engineer the final sign design in the form of an editable picture file in .eps format – Encapsulated PostScript file.

At the completion of the project, the signs will become property of the County. When directed by the Engineer, the Contractor shall remove all hardware from the signs. Posts and hardware shall become the property of the Contractor. The Contractor shall deliver and off-load the signs to the address listed below or as directed by the Engineer:

Traffic Signal Shop
Riverside County Transportation Department
McKenzie Highway Operations Center
2950 Washington Street
Riverside, California 92504
Telephone (951) 955-6894

Method of Payment:

Full compensation for furnishing and installing Construction Project Funding Identification Sign, including transportation, furnishing all labor, materials, tools, equipment, and incidentals and for doing all the required work, including all necessary excavation and backfill, shall be considered as included in the various items of work, and no additional compensation will be allowed therefor.

ITEMS OF WORK:

ORDER OF WORK:

Order of work shall conform to the provisions in section 5-1.05, "Order of Work" of the Standard Specifications and these Special Provisions.

Attention is directed to "Clearing and Grubbing" of these Special Provisions regarding private improvements within the project area. The Contractor shall work directly with the property owners to minimize the disturbance to the private improvements including driveways, fencing, landscaping and decorative features.

PROJECT APPEARANCE:

The Contractor shall maintain a neat appearance to the work.

In any area visible to the public, the following shall apply:

When practicable, broken concrete and debris developed during clearing and grubbing shall be disposed of concurrently with its removal. If stockpiling is necessary, the material shall be removed or disposed of weekly.

The Contractor shall furnish trash bins for all debris from structure construction. All debris shall be placed in trash bins daily. Forms of the falsework that are to be reused shall be stacked neatly concurrently with their removal.

Full compensation for conforming to the provisions in this section, not otherwise provided for, shall be considered as included in the prices paid for the various contract items of work involved and no additional compensation will be allowed therefor.

TRAFFIC CONTROL SYSTEM/ PUBLIC CONVENIENCE/ PUBLIC SAFETY:

Contractor shall prepare construction staging and traffic control plans for review and approval by the Transportation Department.

Proposed plans shall be submitted by the Contractor for review and approval by the Transportation Department at least two weeks prior to the start of construction. The construction staging and traffic control plans shall be prepared, signed and stamped by a Civil Engineer or Traffic Engineer who is registered as such in the State of California, unless otherwise specifically allowed by the Engineer. The Contractor shall revise and implement the plans as directed by the Construction Engineer. Construction shall not begin until the Engineer provides Contractor with County approval of the plans.

Construction staging and traffic control plans shall be in accordance with the appropriate standards and specifications for construction staging, detour roads, traffic control, including the State of California Highway Design Manual, the manual on Uniform Traffic Control Devices 2006 Edition, the corresponding California Supplement, and subsequent modifications as adopted by the State of California Department of Transportation, Standard Plans and Standard Specifications, and the Work Area Traffic Control Handbook (WATCH), as published by Building News, Inc. Any requests for deviation from the established design standards or specifications are to be submitted to the Construction Engineer for review and approval prior to submission of the required plans.

With regard to the preparation and implementation of the plans, attention is especially directed to Sections 7-1.06, 7-1.08, 7-1.09, 7-1.11, 7-1.12 and Section 12 of the State of California Standard Specifications. Section 12-2.02 of the Standard Specifications is deleted.

Maintaining traffic shall conform to the provisions in 7-1.02 "Load Limitations", 7-1.06 "Safety and Health Provisions", 7-1.08 "Public Convenience", 7-1.09 "Public Safety", and 12-3.04 "Portable Delineators" of the Standard Specifications, the Manual on Uniform Traffic Control Devices 2006

Edition, the corresponding California Supplement, and subsequent modifications as adopted by the State of California Department of Transportation, the Section of these contract documents entitled "Insurance - Hold Harmless", and these Special Provisions.

All existing traffic control signs and street name signs shall be maintained in visible locations as directed by the Engineer.

No detours will be provided, unless specifically allowed herein. The Contractor will be required to conduct his operations in such a manner that traffic will be permitted to pass through the work area with as little delay as possible.

Portable changeable message signs shall be furnished, placed, operated and maintained at those locations shown on the approved Traffic Control Plans or where designated by the Engineer in conformance with the provisions in Section 12, "Construction Area Traffic Control Devices" of the Standard Specifications and these Special Provisions.

All warning lights, signs, flares, barricades and other facilities for the sole convenience and direction of public traffic shall be furnished and maintained by the Contractor. All traffic control devices shall conform to and be placed in accordance with the Manual on Uniform Traffic Control Devices 2006 Edition, the corresponding California Supplement, and subsequent modifications as adopted by the State of California Department of Transportation.

All construction signs shall be either covered or removed when not required by the nature of the work or if no present hazard to the motorist exists.

The Contractor shall notify the appropriate regional notification center for operators of subsurface installations at least 2 working days, but not more than 14 calendar days, prior to commencing excavation for construction area sign posts. The regional notification centers include, but not limited to, the following:

Notification Center	Telephone Number
Underground Service Alert-Southern California (USA)	1-800-422-4133 1-800-227-2600 or 811

Excavations required to install construction area signs shall be performed by hand methods without the use of power equipment, except that power equipment may be used if it is determined there are no utility facilities in the area of the proposed post holes.

No payment for extra work will be allowed for work performed as specified in Section 12-2.02 (Flagging Costs) of the Standard Specifications. Flagging costs will be borne entirely by the Contractor.

Dust control shall conform to the provision of Section 10 of the Standard Specifications except that no extra work will be allowed when the Engineer orders the application of water for the purpose of controlling dust caused by public traffic as provided for in the last paragraph of Section 10.

The Contractor shall be responsible to distribute an information letter pertaining to the planned work to all affected residences and businesses, at least one week prior to commencing work adjacent to those residences and businesses. It shall be the responsibility of the Contractor to design the information letter, obtain design approval from the Engineer, print sufficient copies, and distribute the letter. The Transportation Department logo shall be included on the letter. A computer file of the logo may be obtained from the Engineer in .WPG, .DXF, .DGN or .DWG format. The letter shall be similar to the sample provided by the Engineer, and shall include a project description, the scope of work, the anticipated construction schedule, and other information as appropriate.

The Contractor shall post temporary no parking signs on affected streets 24 hours prior to work on those streets. The temporary no parking signs shall state the anticipated dates and hours of work on those streets.

Method of Payment:

Full compensation, except as otherwise provided herein, for conforming to the requirements of this article, including furnishing, installing and maintaining all traffic control devices shown on the construction staging and traffic control plans, shall be paid for on a lump sum basis, and no additional compensation will be allowed therefor.

MAINTAINING TRAFFIC:

Maintaining traffic shall conform to the provisions in Section 7-1.08, "Public Convenience", Section 7-1.09, "Public Safety" and Section 12, "Construction Area Traffic Control Devices" of the Standard Specifications and "Public Safety" of these Special Provisions.

Closure is defined as the closure of a traffic lane or lanes, including shoulder, ramp or connector lanes, within a single traffic control system.

Closure shall conform to the provisions in "Traffic Control System" of these Special Provisions.

Local authorities shall be notified at least five (5) business days before work begins. The Contractor shall cooperate with local authorities to handle traffic through the work area and shall make arrangements to keep the work area clear of parked vehicles.

Personal vehicles of the Contractor's employees shall not be parked on the traveled way or shoulders including sections closed to public traffic.

When work vehicles or equipment are parked on the shoulder within six (6) feet of a traffic lane, the shoulder area shall be closed.

When work vehicles or equipment are parked on the shoulder within six (6) feet of a traffic lane, the shoulder area shall be closed with fluorescent orange traffic cones or portable delineators placed on a taper in advance of the parked vehicles or equipment and along the edge of the pavement at 25-foot intervals to a point not less than 25 feet past the last vehicle or piece of equipment. A minimum of 9 traffic cones or portable delineators shall be used for the taper. A W20-1 (ROAD WORK AHEAD) or W21-5b (RIGHT/LEFT SHOULDER CLOSED AHEAD) or C24 (CA) (SHOULDER WORK AHEAD) sign shall be mounted on a crashworthy portable sign support with flags. The sign shall be

placed where designated by the Engineer. The sign shall be a minimum of 48" x 48" in size. The Contractor shall immediately restore to the original position and location a traffic cone or delineator that is displaced or overturned, during the progress of work.

If minor deviations from the lane requirement chart are required, a written request shall be submitted to the Engineer at least 15 days before the proposed date of the closure. The Engineer may approve the deviations if there is no significant increase in the cost to the County and if the work can be expedited and better serve the public traffic.

Designated legal holidays are January 1st, the third Monday in February, the last Monday in May, July 4th, the first Monday in September, November 11th, Thanksgiving Day, and December 25th. When a designated legal holiday falls on a Sunday, the following Monday shall be a designated legal holiday. When November 11th falls on a Saturday, the preceding Friday shall be a designated legal holiday.

Full compensation for furnishing, erecting, maintaining, removing and disposing of the C43 (CA), W20-1, W21-5b and C24 (CA) signs shall be considered as included in the contract lump sum price paid for Traffic Control System and no additional compensation will be allowed therefor.

GRAFFITI REMOVAL AND CLEANING:

The Contractor shall remove existing graffiti within the project limits and any new graffiti produced during the construction period of the project.

Contractor shall submit a method of graffiti removal plan to the Engineer for approval. Sand blasting will not be allowed. Methods may include but not limited to power washing, solvent washing, and painting over graffiti, as appropriate for the surface to be cleaned.

All graffiti shall be completely removed or obliterated and the area feathered out to hide any imperfections.

Graffiti shall be removed from, but not limited to, the surfaces listed as follows: bricks, cinder blocks, concrete sidewalks, pavement, bridge under passes, overhead structures, drainage channels, roadside signs, temporary construction signs, barricades, k-railing, traffic control devices, and all types of poles, and other objects within the project limits as directed by the Engineer. Painting of k-railing for the purposes of graffiti removal shall not be considered as repainting as outlined in paragraph one of Section 12-3.08 and shall not be paid for as extra work.

Graffiti to be removed may include, but shall not be limited to: paint, signs, wood, metal, plastic, decals, gum, markers, crayons, ropes, chains, strings, wires, and tapes of any kind on an as needed basis.

All painting over graffiti must be done with exact color matches, so as not to show any blocking or shadowing of colors. Painting over graffiti is the preferred option on previously painted surfaces, and where solvents are unsuccessful at removing graffiti. Painting services shall be done on an as needed basis on the following types of surfaces, but not limited to: walls, hardscapes, poles, fences, bollards, railings, and buildings.

Paint shall be exact color match. Paint types may include oil base, water base and enamels as approved by the Engineer. Graffiti cover-up by paint will be allowed with appropriate type of paint at locations where graffiti cannot be removed only upon direction by the Engineer. All paint applications shall adhere to the manufacture's recommendations. All material and solutions shall be safe and biodegradable and approved by the Engineer.

Regional Water Quality Control Board (RWQCB) and Air Quality Management District (AQMD) regulations, as well as all NPDES required best management practices shall be complied with and followed.

The Contractor shall so conduct his operation as to cause the least possible obstruction and inconvenience to public traffic. The Contractor shall provide, erect and maintain barricades, lights, danger signals, and warning signs as deemed appropriate by the Engineer.

When necessary, the Contractor shall provide and erect safe and adequate scaffolding and equipment, barriers, and masking, required for the proper execution of the work. All scaffolding shall be properly braced and erected to insure the safety of the workmen and meet all appropriate OSHA regulations.

The Contractor shall respond and provide manpower for any urgent graffiti removal and cleaning notifications within two (2) working days.

Method of Payment:

Full compensation for conformance with these Graffiti Removal and Cleaning requirements, including labor, equipment, materials, necessary traffic control, and incidentals, shall be paid at the lump sum price for Traffic Control System, and no additional compensation will be allowed therefor.

DEVELOP WATER SUPPLY:

Develop water supply shall conform to the provisions of Section 17 of the Standard Specifications and these Special Provisions.

Attention is directed to the requirements of Section 10, "Dust Control".

Method of Payment:

Full compensation for developing water supply and furnishing watering equipment shall be considered as included in the prices paid for the various contract items of work involved and no additional compensation will be allowed therefor.

WATER POLLUTION CONTROL (SANTA ANA RIVER BASIN REGION):

Throughout the term of this contract, the total land disturbance area of the project site shall be less than 1 acre. The Contractor shall comply with the Area-Wide Municipal Stormwater Permit NPDES No. CAS 618033, hereafter referred to in this section as the "Municipal Permit", issued by the California Regional Water Quality Control Board (CRWQCB) – Santa Ana Region. This Permit regulates both stormwater and non-stormwater discharges associated with Contractor's construction activities. A copy of the Permit may be obtained at the office of the County of Riverside Transportation Department, 14th Street Transportation Annex, 3525 14th Street, Riverside, California. (951) 955-6780, or may be obtained on the internet at:

<http://www.waterboards.ca.gov/santaana/>

The Contractor shall comply with the requirements of the Municipal Permit, and all other applicable federal, state and local laws, ordinances, statutes, rules, and regulations concerning water pollution control.

Contractor's Water Pollution Control Program (WPCP) shall be prepared by a Qualified SWPPP Developer in accordance with Section 3, "Preparing a Water Pollution Control Program (WPCP)", of the *Caltrans Stormwater Pollution Prevention Plan (SWPPP) and Water Pollution Control Program (WPCP) Preparation Manual (March 2007)*, which is available as a free download from:

<http://www.dot.ca.gov/hq/construc/stormwater/manuals.htm>

WATER POLLUTION CONTROL MEASURES

- A. Work having the potential to cause water pollution shall not commence until the Contractor's WPCP has been reviewed and approved by the Engineer. The Engineer's review and approval of the Contractor's WPCP shall not waive any contractual requirements and shall not relieve the Contractor from achieving and maintaining compliance with all federal, state, and local laws, ordinances, statutes, rules, and regulations. A copy of Contractor's WPCP shall be maintained onsite. When the WPCP or access to the construction site is requested by a representative of a federal, state, or local regulatory agency, Contractor shall make the WPCP available and Contractor shall immediately contact the Engineer. Requests from the public for the Contractor's WPCP shall be directed to the Engineer.
- B. Contractor's WPCP shall describe the Contractor's plan for managing runoff during each construction phase. Contractor's WPCP shall describe the Best Management Practices (BMPs) that will be implemented to control erosion, sediment, tracking, construction materials, construction wastes, and non-stormwater flows. BMP details shall be based upon California Stormwater Quality Association's 2009 California Stormwater Quality BMP Handbook Portal (<http://www.cabmphandbooks.com>) or the Caltrans Construction Site BMP Manual (<http://www.dot.ca.gov/hq/construc/stormwater/manuals.htm>). Contractor's WPCP shall describe installation, operation, inspection, maintenance, and monitoring activities that will be implemented for compliance with the Municipal Permit and all applicable federal, state, and local laws, ordinances, statutes, rules, and regulations related to the protection of water quality.

- C. The Contractor's WPCP preparer shall have been trained to prepare WPCPs or SWPPPs and shall have previous experience with preparing SWPPP or WPCP requirements on a previous project.

The Contractor shall designate a Water Pollution Control Manager that shall have been trained to implement WPCP or SWPPP requirements. Contractor's Water Pollution Control Manager shall:

1. Be responsible for all water pollution control work.
2. Be the Engineer's primary contact for all water pollution control work.
3. Have the authority to mobilize resources (crews, supplies, equipment, etc.) to make immediate repairs of water pollution control measures or to supplement water pollution control measures to maintain compliance with all federal, state, and local laws, ordinances, and regulations related to the protection of water quality, including the Municipal Permit.

The WPCP shall contain all required and applicable certifications and evidence of training for the Water Pollution Control Manager, WPCP Developer, and all other employees working on the project receiving formal training or certification.

- D. Water Pollution Control Training: Contractor shall provide water pollution control training to Contractor's employees and subcontractors prior to their performing work on the work site. The water pollution control training shall be appropriate to the employee or subcontractor function and area of responsibility and shall address (as applicable):

1. Erosion Control (water and wind)
2. Sediment Control
3. Tracking Control
4. Materials & Waste Management
5. Non-Stormwater Discharge Management

- E. Monitoring and Reporting: Observations and inspections conducted by the Contractor's Water Pollution Control Manager shall be documented on the Construction Site Inspection Checklist included in Contractor's WPCP. A copy of each completed Construction Site Inspection Checklist shall be submitted to the Engineer within 24 hours of conducting the inspection.

General Requirements:

In the event the County incurs any Administrative Civil Liability (fine) imposed by the CRWQCB – Santa Ana Region, the State Water Resources Control Board, or EPA, as a result of Contractor's failure to fully implement the provisions of "Stormwater and Non-Stormwater Pollution Control", the Engineer, may, in the exercise of his sole judgment and discretion, withhold from payments otherwise due Contractor a sufficient amount to cover the Administrative Civil Liability including County staff time, legal counsel, consultant support costs and all other associated cost.

The Contractor shall be responsible for all costs and for any liability imposed by law as a result of the Contractor's failure to comply with the requirements set forth in "Water Pollution Control", including but not limited to, compliance with the applicable provisions of the Caltrans Handbooks, Municipal Permit, Federal, State, and local regulations. For the purpose of this paragraph, costs and liabilities include, but not limited to, fines, penalties, damages, and costs associated with defending against

enforcement actions whether taken against the County or the Contractor, including those levied under the Federal Clean Water Act and the State Porter-Cologne Water Quality Act.

Within fifteen (15) working days after the award of the contract, the Contractor shall submit two (2) copies of the WPCP to the Engineer for review and approval. The Contractor shall allow ten (10) working days for the Engineer to review the WPCP. If revisions are required as determined by the Engineer, the Contractor shall revise and resubmit the WPCP within three (3) working days of receipt of the Engineer's comments and shall allow ten (10) working days for the Engineer to review the revisions. The Contractor shall submit four (4) copies of the approved WPCP to the Engineer prior to notice to proceed. The Contractor must have an approved WPCP prior to the notice to proceed. The Engineer may provide a letter of conditional approval of the Contractor's WPCP while minor revisions are made and may allow the Contractor to begin only those certain construction activities identified in the letter of conditional approval. In no case will the conditional approval extend beyond twenty-one (21) calendar days. The Engineer may suspend construction operations until the Contractor submits a revised WPCP that is reviewed and approved by the Engineer.

Unless otherwise directed by the Engineer or specified in these Special Provisions, the Contractor's responsibility for WPCP implementation shall continue throughout any temporary suspension of work ordered in accordance with Section 8-1.05, "Temporary Suspension of the Work", of the Standard Specifications. The Engineer may withhold progress payments or order the suspension of construction operations without an extension of the contract time, if the Contractor fails to comply with the requirements of "Water Pollution Control" as determined by the Engineer.

All BMP repairs shall be implemented by the Contractor within 72 hrs.

Method of Payment:

Payment for Water Pollution Control shall be on a lump sum basis and shall include full compensation for the work performed, including, developing, preparing, revising, obtaining approval of, and amending the WPCP, implementing, installing, constructing, operating, maintaining, and removing and disposing of temporary BMPs, performing the observations, inspections, sampling, analysis, reporting, and street sweeping, and as specified in the Caltrans Handbooks, Municipal Permit and these Special Provisions, and as directed by the Engineer.

STREET SWEEPING:

GENERAL

Summary

This work includes street sweeping.

The WPCP shall describe and include the use of street sweeping as a Water Pollution Control practice for sediment control and tracking control. Street sweeping shall also conform to all applicable AQMD requirements.

Submittals

At least 5 working days before starting clearing and grubbing, or other activities with the potential for tracking sediment or debris, submit:

- A. The number of street sweepers that will be used as described in the WPCP.
- B. Type of sweeper technology (or technologies).

Quality Control and Assurance

Retain the following records related to street sweeping and submit weekly to Engineer:

- A. Tracking Inspection Log
- B. Sweeping times and locations.
- C. Quantity of sweeping waste disposal.

CONSTRUCTION

Street Sweepers

Sweepers must use one of these technologies:

- A. Mechanical sweeper followed by a vacuum-assisted sweeper.
 - B. Vacuum-assisted dry (waterless) sweeper.
 - C. Regenerative-air sweeper.
- or
- D. Sweeping by hand is acceptable in lieu of A, B, and C above.

Operation

Street sweeping shall be conducted at:

- A. Paved roads at job site entrance and exit locations.
- B. Paved areas within the job site that flow to storm drains or water bodies.

Street sweeping shall be conducted, and sweeper(s) shall be available to operate at all times, for the following:

- A. During clearing and grubbing activities.
- B. During earthwork activities.
- C. During trenching activities.
- D. During roadway structural section activities.
- E. When vehicles are entering and leaving the job site.
- F. After soil disturbing activities.
- G. After observing offsite tracking of material.

Contractor's Water Pollution Control Manager shall inspect adjacent paved areas at job site entrances and exits and paved roadways within the job site on a minimum daily basis, and more frequently when activities that require street sweeping are being performed. Contractor's Water Pollution Control Manager shall maintain a "Tracking Inspection Log." Street sweeping shall be conducted:

A. Within 1 hour, if sediment or debris is observed on paved areas or paved roadways.

At least one sweeper, in good working order, must be available within 4 hours to be on the job site when sweeping work may be required.

Perform street sweeping to minimize dust. If dust generation is excessive or sediment pickup is ineffective, water may be used but shall be contained, collected (e.g. vacuum), and properly disposed.

Material collected during street sweeping must be removed and disposed of under Section 7-1.13, "Disposal of Material Outside the Highway Right of Way" of the Standard Specifications.

Method of Payment:

Full compensation to conform with the requirements of this section shall be considered as included in the contract lump sum price paid for Water Pollution Control including furnishing all labor, materials, tools, equipment, and incidentals and for doing all the work involved in street sweeping, including disposal of collected material, as shown on the plans, as specified in the Standard Specifications, these Special Provisions, and as directed by the Engineer. Therefore, no additional compensation will be allowed for street sweeping.

CLEARING AND GRUBBING:

Clearing and grubbing **including but not limited to removing vegetation, removing additional trees, tree stumps encountered within the project limits (right of way and private property), and removal of existing telephone pedestal foundation** shall conform to the provisions in Section 16 of the Standard Specifications.

Shrubs and bushes shall be removed as directed by the Engineer and disposed of completely.

Removed vegetation and hardscape shall be the property of the Contractor and shall be disposed of by the Contractor, as provided in Section 7-1.13 of the Standard Specifications.

Arundo donax (giant reed)

Arundo donax shall be removed by cutting the stems near the base, followed by treatment with an approved herbicide, "Aquamaster" manufactured by Monsanto Company or "Rodeo" manufactured by Dow AgroSciences. Such treatment shall be painting the cut stump with herbicide within five minutes of cutting. The cut stems shall be shredded and hauled away to a landfill. Remedial treatments of any resprouting Arundo donax may be necessary.

Method of Payment:

Full compensation, except as otherwise provided herein, for conforming to the requirements of this article including but not limited to **removing vegetation, removing additional trees, tree stumps encountered within the project limits (right of way and private property), and removal of existing telephone pedestal foundation** at the locations shown on the plans and as directed by the Engineer shall be paid for on a lump sum basis and no additional compensation will be allowed therefor.

REMOVE TREES:

Trees and bushes shall be removed as shown on the plan and/or as directed by the Engineer.

Removed trees and trimmings shall be the property of the Contractor and shall be disposed of by the Contractor, as provided in Section 7-1.13 of the Standard Specifications.

Regulatory Requirements

Attention is directed to the Federal Migratory Bird Treaty Act (15 USC 703-711) 50 CFR Part 21 and 50 CFR Part 10, and the California Department of Fish and Game Code Sections 3503, 3513 and 3800, that protect migratory birds, their occupied nests, and their eggs from disturbance or destruction.

Construction

Ground disturbance, tree, shrub and/or vegetation removal that occurs between February 15th and September 1st will not commence until a preconstruction survey for nesting birds has verified that no active nests have been located or the Engineer has approved the beginning of work. If an active nest is located, construction within 500 feet of the nest must be avoided until the nest has been vacated and the young are independent of their parents.

Between February 15th and September 1st, the Contractor shall notify the Engineer 15 working days prior to beginning work disturbing structures, the ground or vegetation. The Engineer will approve the beginning of work disturbing the ground or vegetation between February 15th and September 1st.

The Contractor shall use exclusion techniques directed by the Engineer to prevent migratory birds from nesting on the ground, on structures or in trees, shrubs or other vegetation within the project limits.

If evidence of bird nesting is discovered, the Contractor shall not disturb the nesting birds or nests until the birds have naturally left the nests. If evidence of migratory bird nesting is discovered after beginning work, the Contractor shall immediately stop work within 500 feet of the nests and notify the Engineer. Work shall not resume until the Engineer provides a written notification that work may begin at or adjacent areas of the discovered bird nest locations.

Attention is directed to Section 8-1.05, "Temporary Suspension of Work" of the Standard Specifications.

Nothing in this section shall relieve the Contractor from providing for public safety in conformance with the provisions in Section 7-1.09, "Public Safety" of the Standard Specifications.

Method of Payment and Penalties

If, in the opinion of the Engineer, completion of the work is delayed or interfered with by reason of the Engineer's delay in approving the disturbance structures, ground or vegetation, the Contractor will be compensated for resulting losses, and an extension of time will be granted, in the same manner as provided for in Section 8-1.09, "Right of Way Delays" of the Standard Specifications.

Preventing nesting by using appropriate exclusion techniques will be paid for as extra work as provided in Section 4-1.03D, "Extra Work" of the Standard Specifications.

Notwithstanding any other remedies authorized by law, the Department may retain or withhold monies due the Contractor under the contract, in an amount determined by the Department, up to and including the entire amount of penalties proposed, assessed, or levied as a result of the Contractor's violation of Federal or State law, regulations or requirements. Funds may be retained by the Department until final disposition has been made as to the penalties. The Contractor shall remain liable for the full amount of penalties until such time as they are finally resolved with the entity seeking the penalties. Upon final disposition, the Department shall inform the Contractor or the withheld amount.

Penalties as used in this section, "General Migratory Bird Protection" shall include fines, penalties, and damages whether proposed, assessed, or levied against the Department or the Contractor. Penalties shall also include payments or costs incurred in settlement for alleged violations of applicable laws, regulations, or requirements. Costs incurred could include sums spent instead of penalties, in mitigation or to remediate or correct violations.

Exclusion devices, nesting prevention measures, and nest removal that are ordered by the Engineer shall be compensated per Section 5-1.15 "Force Account Payment" of the General Provisions.

Full compensation, except as otherwise provided herein, for conforming to the requirements of this article, including all labor, equipment, materials and incidentals, to remove trees and bushes as shown on the plans or as directed by the engineer, shall be paid per each and no additional compensation will be allowed therefor.

ROADWAY EXCAVATION:

Roadway excavation shall conform to the provisions of Section 19 of the Standard Specifications and these Special Provisions. All large rocks and boulders larger than 1 foot in greatest dimension encountered during roadway excavation shall be considered unsuitable material and shall conform to Section 19-2.02 of the Standard Specifications.

At road connections and at limits of asphalt paving, existing pavement shall be header cut as shown on the plans or as directed by the Engineer. Full compensation for furnishing all labor, tools and doing all the work necessary including grinding, and sawcutting shall be considered as included in the contract prices paid per ton for the various asphalt concrete items and no additional compensation will be allowed therefor.

Existing pavement including any base material shall be cut back to neat lines and removed as shown on the plans or as directed by the Engineer. Excess material will become the property of the Contractor and will be disposed of as provided in Section 7-1.13 of the Standard Specifications.

Construction of curb and gutter, signal conduits, sidewalk, drieways, median, and other improvements will require the removal of 2-sack slurry cement backfill material found at existing reinforced concrete box storm drains on Ontario Avenue/Temescal Canyon Road approximately between Sta 11+15 and Sta 12+00.

Full compensation for the necessary removal of 2-sack slurry cement backfill material encountered during excavation shall be considered as included in the contract bid price paid per cubic yard for Roadway Excavation and no additional compensation will be allowed therefor.

Relative Compaction

Relative compaction shall conform to the provisions of Section 19-5.03, "Relative Compaction (95 Percent)" of the Standard Specifications, these Special Provisions and/or as directed by the Engineer.

Whenever relative compaction is specified to be determined by Test Method No. Calif. 216, the in-place density may be determined by Test Method No. Calif. 231. The in-place density required by Test Method No. Calif. 312 may be determined by Test Method No. 231. The wet weight or dry weight basis and English Units of Measurement may be used at the option of the Materials Engineer.

Method of Payment:

The contract unit bid price paid per cubic yard for Roadway Excavation shall include full compensation for furnishing all labor, materials, tools, equipment, and incidentals, and for doing all work involved including the compaction of the subgrade and the grading of the shoulder as directed by the Engineer and no additional compensation will be allowed therefor.

COLD PLANE AND WEDGE PLANE ASPHALT CONCRETE PAVEMENT:

The Contractor shall cold plane the asphalt concrete pavement to a depth as shown on the approved plans or as directed by the Engineer.

The Contractor shall wedge plane 6 feet adjacent to the concrete curb and gutter to a depth as shown on the plans below the lip of the gutter and a depth of 0.027 foot six feet from the gutter or as directed by the Resident Engineer.

The cold plane machine shall have a cutter head at least 72 inches wide and shall be operated so as not to produce fumes or smoke.

The depth, width and shape of the cut shall be as indicated on the plans. The outside lines of the planed area shall be neat and uniform. The road surfacing to remain in place shall not be damaged in any way.

The material planed from the roadway surface, including material deposited in existing gutters or on the adjacent traveled way shall become the property of the Contractor and shall be immediately removed from the site of the work and disposed of as provided in Section 7-1.13, "Disposal of Material Outside the Highway Right of Way", of the Standard Specifications. The removal crew shall follow within 50 feet of the planer, unless otherwise directed by the Engineer.

Nothing in these Special Provisions shall relieve the Contractor from his responsibilities as provided in Section 7-1.09, "Public Safety" of the Standard Specifications.

Method of Payment:

The contract unit bid price paid per square yard for Cold Plane Asphalt Concrete Pavement shall include full compensation for providing all labor, tools, equipment and disposing of the grindings, and no additional compensation will be allowed therefor.

ROUT AND SEAL RANDOM CRACKS:

All cracks will be filled with a rubberized asphalt material that has a minimum softening point temperature of 200 degrees Fahrenheit and a safe heating temperature of 380 degrees Fahrenheit, or as otherwise directed by the Engineer.

For cracks in size of 1/4 inch to 1/2 inch in width, the crack shall be widened using a router to form a sealant reservoir which is a minimum of 1/2 inch wide and 3/4 inch to 1 inch deep. The routed crack shall then be cleaned with compressed air to remove all dust and free moisture, and then sealed to service level. If a 3/8 inch asphalt concrete mix overlay is to be used, the filler material shall be deleted.

Cracks wider than 1/2 inch width shall be cleaned for the entire crack depth using sandblasting, brushing and air blowing techniques, as required to provide a crack free from all debris, dust, loose material and moisture. Gauging or plowing may be required to remove incompressible deep in the crack. The clean crack shall be filled with sealant, from the bottom up to surface level, in a manner which does not result in sealant bridging or entrapped air pockets. With deep cracks, settlement of sealant may occur, thus requiring application of a second layer of sealant material. For cracks with depressed surfaces on each side of the crack shall be over filled beyond level with pavement surface and then squeezed to fill in depressed area.

Cracks wider than 1 inch width shall be filled with pea-gravel and SS grade asphaltic emulsion as directed by the Engineer.

APPLICATION OF HERBICIDE AND WEED REMOVAL

Herbicide shall be applied to all visible weeds and vegetation, and to all cracks exceeding 1/4 inch in width, within the pavement areas at least 10 days prior to removal of weeds and vegetation, or longer if the manufacturer's recommendation is for a period of time in excess of 10 days. All weeds and vegetation shall be removed from the pavement areas.

The herbicide used shall meet all Federal, State and County health and safety requirements for the intended use of the product, as described herein. Contractor shall obtain specific approval from the Engineer for the use of the herbicide proposed by the Contractor.

Contractor shall provide all necessary protection to prevent injury to adjacent plant life or property from herbicide. The Contractor will be held responsible for any personal injury or property damage caused by the transportation, storage or application of herbicides.

The Contractor shall notify the Engineer two days in advance prior to any application of herbicide.

Herbicide shall be applied by a Contractor that is properly licensed to do this work.

Method of Payment:

Payment for Rout And Seal Random Cracks shall be considered as included in the Lump Sum bid priced paid for Clearing and Grubbing which shall include full compensation for furnishing all labor, materials, tools, equipment and incidentals required for cracks routing, cracks cleaning, sweeping and application of herbicide and sealant, as directed by the Engineer and no additional compensation will be allowed therefor.

AGGREGATED BASE:

Aggregate base shall be Class 2 and shall conform to the provisions in Section 26, "Aggregate Bases" of the Standard Specifications and these Special Provisions and shall meet the gradation requirements for ¾ inch maximum.

The first paragraph of Section 26-1.02A, "Class 2 Aggregate Base" shall be modified to read:

Aggregate for Class 2 aggregate base shall be free from organic matter and other deleterious matter, and shall be of such nature that it can be compacted readily under watering and rolling to form a firm and stable base. Aggregate may consist of broken and crushed asphalt concrete or Portland cement concrete and may contain crushed aggregate base or other rock materials. The material may contain no more than 3 percent brick by weight as determined by California Test Method 202 as modified: Brick material retained on a No.4 sieve shall be identified visually and separated manually. Brick quantification shall be based on total weight of dry sample. Also, material retained on the 4.75 mm (No.4) sieve shall contain no more than 15 percent of particles (gravel) that have no more than one fractured face.

The Quality Requirements contained in Section 26-1.02A shall be modified to read:

QUALITY REQUIREMENTS

Test	Contract Compliance
Resistance (R-Value)	
Virgin Rock	78 Minimum
Crushed Miscellaneous	80 Minimum
Sand Equivalent	
Virgin Rock	25 Minimum
Crushed Miscellaneous	35 Minimum
Durability Index	35 Minimum
Percentage Wear	
100 Revolutions	15 Maximum
500 Revolutions	52 Maximum

Parking Lot- Soil Sterilizer

An approved soil sterilizer shall be applied on the subgrade surface of the proposed parking lot area prior to the installation of Class 2 aggregate base. Payment for applying soil sterilizer over the parking lot area shall be considered as included in the contract price paid per cubic yard for Class 2 Aggregate Base and shall include full compensation for furnishing all labor, materials, tools, equipment and incidentals, as directed by the Engineer and no additional compensation will be allowed therefor.

Method of Payment:

Quantities of Aggregate Base will be paid for at the contract unit price per cubic yard and in accordance with the provisions of Sections 26-1.06 and 26-1.07 of the Standard Specifications.

HOT MIX ASPHALT CONCRETE (Type A):

The asphalt concrete shall be Type "A" and shall conform to the requirements of Section 39 of the Standard Specifications and the following:

Aggregate grading shall be three-quarter inch (3/4") maximum.

The asphalt lift thickness table, as shown in Section 39-6.01, "General Requirements" of the Standard Specifications, is revised as follows:

Total Thickness Shown on Plans	Minimum No. of Layers	Top Layer Thickness (foot)		Next Lower Layer Thickness (foot)		All Other Lower Layer Thickness (foot)	
		Min.	Max.	Min.	Max.	Min.	Max.
0.24-foot or less ^a	1	-	-	-	-	-	-
0.25-foot	2 ^b	0.12	0.13	0.12	0.13	-	-
0.26 - 0.46 foot	2	0.12	0.21	0.14	0.25	-	-
0.47-foot or more	3 or more	0.15	0.21	0.15	0.25	0.17	0.25

Footnotes to asphalt thickness table are revised as follows:

- a. No Change.
- b. One layer of 0.25 foot thick may be placed as approved by the Engineer. When the Traffic Index specified is 5.5 or below, two layers shall be placed.

Asphalts:

Asphalt shall conform to the provisions in this Section, "Asphalts". Section 92, "Asphalts" of the Standard Specifications shall not apply.

Asphalt shall consist of refined petroleum or a mixture of refined liquid asphalt and refined solid asphalt, prepared from crude petroleum. Asphalt shall be:

1. Free from residues caused by the artificial distillation of coal, coal tar, or paraffin;
2. Free from water;
3. Homogeneous.

General:

The Contractor shall furnish asphalt in conformance with the State of California Department of transportation's Certification Program for Suppliers of Asphalt". The Department maintains the program requirements, procedures, and a list of approved suppliers at <http://www.dot.ca.gov/hq/esc/Translab/fpmcoc.htm>.

The Contractor shall ensure the safe transportation, storage, use, and disposal of asphalt.

The Contractor shall prevent the formation of carbonized particles caused by overheating asphalt during manufacturing or construction.

Grade:

Performance graded (PG) asphalt binder shall conform to the following:

Property	AASHTO Test Method	Specification Grade		
		PG 64-10	PG 64-16	PG 70-10
Original Binder				
Flash Point, Minimum °C	T48	230	230	230
Solubility, Minimum % ^b	T44	99	99	99
Viscosity at 135 °C, Maximum, Pa s	T316	3.0	3.0	3.0
Dynamic Shear, Test Temp. at 10 rad/s, °C Minimum G*/sin(delta), kPa	T315	64 1.00	64 1.00	70 1.00
RTFO Test ^e , Mass Loss, Maximum, %	T240	1.00	1.00	1.00
RTFO Test Aged Binder				
Dynamic Shear, Test Temp. at 10 rad/s, °C Minimum G*/sin(delta), kPa	T315	64 2.20	64 2.20	70 2.20
Ductility at 25 °C Minimum, cm	T51	75	75	75
PAV ^f Aging, Temperature, °C	R28	100	100	110
RTFO Test and PAV Aged Binder				
Dynamic Shear, Test Temp. at 10 rad/s, °C Maximum G*/sin(delta), kPa	T315	31 ^d 5000	28 ^d 5000	34 ^d 5000
Creep Stiffness, Test Temperature, °C Maximum S-value, Mpa Minimum M-value	T313	0 300 0.300	-6 300 0.300	0 300 0.300

Notes:

- a. Not used.
- b. The Engineer will waive this specification if the supplier is a Quality Supplier as defined by Department's "Certification Program for Suppliers of Asphalt".
- c. The Engineer will waive this specification if the supplier certifies the asphalt binder can be adequately pumped and mixed at temperatures meeting applicable safety standards.
- d. Test the sample at 3 °C higher if it fails at the specified test temperature. G* sin(delta) shall remain 5000 kPa maximum.
- e. "RTFO Test" means the asphaltic residue obtained using the Rolling Thin Film Oven Test; AASHTO Test Method T240 or ASTM Designation: D2827.
- f. "PAV" means Pressurized Aging Vessel.

Performance graded polymer modified asphalt binder (PG Polymer Modified) is:

Performance Graded Polymer Modified Asphalt Binder ^a				
Property	AASHTO Test Method	Specification Grade		
		PG 58-34 PM	PG 64-28 PM	PG 76-22 PM
Original Binder				
Flash Point, Minimum °C	T 48	230	230	230
Solubility, Minimum % ^b	T 44 ^c	98.5	98.5	98.5
Viscosity at 135°C, ^d Maximum, Pa·s	T 316	3.0	3.0	3.0
Dynamic Shear, Test Temp. at 10 rad/s, °C Minimum G*/sin(delta), kPa	T 315	58 1.00	64 1.00	76 1.00
RTFO Test, Mass Loss, Maximum, %	T 240	1.00	1.00	1.00
RTFO Test Aged Binder				
Dynamic Shear, Test Temp. at 10 rad/s, °C Minimum G*/sin(delta), kPa	T 315	58 2.20	64 2.20	76 2.20
Dynamic Shear, Test Temp. at 10 rad/s, °C Maximum (delta), %	T 315	Note e 80	Note e 80	Note e 80
Elastic Recovery ^f , Test Temp., °C Minimum recovery, %	T 301	25 75	25 75	25 65
PAV ^g Aging, Temperature, °C	R 28	100	100	110
RTFO Test and PAV Aged Binder				
Dynamic Shear, Test Temp. at 10 rad/s, °C Maximum G*/sin(delta), kPa	T 315	16 5000	22 5000	31 5000
Creep Stiffness, Test Temperature, °C Maximum S-value, MPa Minimum M-value	T 313	-24 300 0.300	-18 300 0.300	-12 300 0.300

Notes:

- a. Do not modify PG Polymer Modifier using acid modification.
- b. The Engineer waives this specification if the supplier is a Quality Supplier as defined by the Department's "Certification Program for Suppliers of Asphalt".
- c. The Department allows ASTM D5546 instead of AASHTO T44.
- d. The Engineer waives this specification if the supplier certifies the asphalt binder can be adequately pumped and mixed at temperatures meeting applicable safety standards.
- e. Test temperature is the temperature at which G*/sin(delta) is 2.2 kPa. A graph of log G*/sin(delta) plotted against temperature may be used to determine the test temperature when G*/sin(delta) is 2.2 Kpa. A graph of (delta) versus temperature may be used to determine delta at the temperature when G*/sin(delta) is 2.2 kPa. The Engineer also accepts direct measurement of (delta) at the temperature when G*/sin(delta) is 2.2 kPa.
- f. Test without a force ductility clamp may be performed.
- g. "PAV" means Pressurized Aging Vessel.

Sampling:

The Contractor shall provide a sampling device in the asphalt feed line connecting the plant storage tanks to the asphalt weighing system or spray bar. The sampling device shall be accessible between 24 and 30 inches above the platform. The Contractor shall provide a receptacle for flushing the sampling device.

The sampling device shall include a valve:

1. With a diameter between 1/2 and 3/4 inches;
2. Manufactured in a manner that a one-quart sample may be taken slowly at any time during plant operations;
3. Maintained in good condition.

Replace Failed Valves:

In the presence of the Engineer, the Contractor shall take 2 one-quart samples per operating day. The Contractor shall provide round friction top containers with one-quart capacity for storing samples.

Applying Asphalt:

Unless otherwise specified, the Contractor shall heat and apply asphalt in conformance with the provisions in Section 93, "Liquid Asphalts" of the Standard Specifications.

Section 39-2.01, "Asphalts" is replaced in its entirety with the followings:

Asphalt binder to be mixed with aggregate shall conform to the provisions in "Asphalts" of these Special Provisions.

The grade of asphalt binder shall be PG 70-10.

Liquid asphalt for prime coat shall conform to the provisions in Section 93, "Liquid Asphalts" of the Standard Specifications and shall be Grade 64-10 unless otherwise designated by the contract item or otherwise specified in the Special Provisions.

Asphaltic emulsion for paint binder (tack coat) shall conform to the provisions in Section 94, "Asphaltic Emulsion" of the Standard Specifications for the rapid-setting or slow-setting type and grade approved by the Engineer.

Section 39-3.01B (1) shall be amended to include:

Aggregate of the 3/4 inch or 1/2 inch maximum size and aggregate for asphalt concrete base shall be separated into 3 or more sizes and each size shall be stored in separate bins. If 3 sizes are used, one bin shall contain that portion of the material which will pass the maximum size specified and be retained on a 3/8 inch sieve; one bin shall contain that portion of the material which will pass a 3/8

inch sieve and be retained on a No. 8 sieve; and one bin shall contain that portion of the material which will pass a No. 8 sieve.

Aggregate of 3/8 inch maximum size shall be separated into 2 sizes and each size shall be stored in separate bins. One bin shall contain that portion of the material which will pass the maximum size specified and be retained on a No. 8 sieve and one bin shall contain that portion of the material which will pass a No. 8 sieve.

The bin containing the fine material shall not contain more than 15 percent of material retained on the No. 8 sieve. The material in any of the other bins shall not contain more than 15 percent of material passing a No. 8 sieve. Failure to comply with this requirement shall be corrected immediately, and the material in the bins not meeting these requirements shall be re-screened or wasted.

All asphalt concrete for this project shall be supplied from one source unless approved by the Engineer. Said source shall be listed on the Contractors Source of Materials List as required in Section 6 of the Standard Specifications.

Asphaltic emulsion shall be furnished and applied as provided in Section 39-4.02.

In addition to the provisions in Section 39-5.01, "Spreading Equipment" of the Standard Specifications, asphalt paving equipment shall be equipped with automatic screed controls and a sensing device or devices.

When placing asphalt concrete to the lines and grades established by the Engineer, the automatic controls shall control the longitudinal grade and transverse slope of the screed. Grade and slope references shall be furnished, installed, and maintained by the Contractor. Should the Contractor elect to use a ski device, the minimum length of the ski device shall be 30 feet. The ski device shall be a rigid one piece unit and the entire length shall be utilized in activating the sensor.

When placing the initial mat of asphalt concrete on existing pavement, the end of the screed nearest the centerline shall be controlled by a sensor activated by a ski device not less than 30 feet. The end of the screed farthest from centerline shall be controlled by an automatic transverse slope device set to reproduce the cross slope designated by the Engineer, by a sensor activated by a similar ski device or as directed by the Engineer.

When paving contiguously with previously placed mats, the end of the screed adjacent to the previously placed mat shall be controlled by a sensor that responds to the grade of the previously placed mat and will reproduce the grade in the new mat within a 0.12 inch tolerance. The end of the screed farthest from the previously placed mat shall be controlled in the same way it was controlled when placing the initial mat.

Should the methods and equipment furnished by the Contractor fail to produce a layer of asphalt concrete conforming to the provisions, including straightedge tolerance, of Section 39-6.03, "Compacting" of the Standard Specifications or elsewhere in these Special Provisions, the paving operations shall be discontinued and the Contractor shall modify the equipment or methods, or furnish substitute equipment.

Should the automatic screed controls fail to operate properly during a day's work, the Contractor may manually control the spreading equipment for the remainder of that day. However, the equipment shall be corrected or replaced with alternative automatically controlled equipment conforming to the provisions in this section before starting another day's work.

General Criteria For Profiling:

In addition to the straightedge provisions in Section 39-6.03, "Compacting" of the Standard Specifications, asphalt concrete pavement shall conform to the surface tolerances specified herein.

The uppermost layer of asphalt concrete surfacing shall be profiled in the presence of the Engineer using a California Profilograph or equivalent in conformance with California Test 526 and as specified in these Special Provisions.

The California Profilograph or equivalent will not be required for the following areas of the pavement surface but shall conform to the straightedge requirements in Section 39-6.03, "Compacting" of the Standard Specifications:

1. Pavement with a total thickness less than 0.24 foot;
2. Pavement on horizontal curves with a centerline curve radius of less than 1,000 feet and the pavement within the superelevation transition on those curves;
3. Pavement placed in a single lift when required by the Special Provisions;
4. Pavement with extensive grade or cross slope correction which does not receive advance leveling operations in conformance with the provisions in Section 39-6.02, "Spreading" of the Standard Specifications;
5. Pavement for ramps and connectors with steep grades and high rates of superelevation, as determined by the Engineer;
6. Shoulders and miscellaneous areas.

The Contractor shall conform to California Test 526, except a zero (null) blanking band shall be used for determining the Profile Index. Prior to beginning profiles, the profilograph shall be calibrated in the presence of the Engineer. Two profiles shall be obtained within each traffic lane, 3 feet from and parallel with the edges of the lane.

Pavements profiled shall conform to the following Profile Index requirements:

1. Pavement on tangent alignment and pavement on horizontal curves having a centerline curve radius of 2,000 feet or more shall have a Profile Index of 0.16 foot or less for each 330 feet section profiled;
2. Pavement on horizontal curves having a centerline curve radius of 1,000 feet or more but less than 2,000 feet, including the pavement within the superelevation transition of these curves, shall have a Profile Index of 0.32 foot or less for each 330 feet section profile;

3. Pavement within any 330 feet section, containing high point areas with deviations in excess of 0.025 foot in a length of 25 feet or less, when tested in conformance with the requirements in California Test 526, shall be corrected by the Contractor regardless of the Profile Index.

The Contractor shall complete initial runs of the profilograph prior to opening the pavement to public traffic. If initial profiles cannot be made prior to opening the pavement to public traffic, the initial runs of the profilograph shall be made the next day that traffic control is permitted for the area to be profiled.

Areas of the top surface of the uppermost layer of asphalt concrete pavement that do not meet the specified surface tolerances shall be brought within tolerance by abrasive grinding.

Abrasive grinding shall be performed to reduce individual deviations in excess of 0.025 foot, and to reduce the Profile Index of the pavement to be within the specified tolerance. Areas which have been subjected to abrasive grinding shall receive a seal coat. Deviations in excess of 0.025 foot which cannot be brought into specified tolerance by abrasive grinding shall be corrected by either (1) removal and replacement or (2) placing an overlay of asphalt concrete. The corrective method for each area shall be selected by the Contractor and shall be approved by the Engineer prior to beginning the corrective work. Replacement or overlay pavement not meeting the specified tolerances shall be corrected by the methods specified above. Corrective work shall be at the Contractor's expense. The Contractor shall run profilograms on the areas that have received abrasive grinding or corrective work until the final profilograms indicate the Profile Index of the area is within the specified tolerance.

When abrasive grinding is used to bring the top surface of the uppermost layer of asphalt concrete surfacing within the specified surface tolerances, additional abrasive grinding shall be performed as necessary to extend the area ground in each lateral direction so that the lateral limits of grinding are at a constant offset from, and parallel with, the nearest lane line or pavement edge, and in each longitudinal direction so that the grinding begins and ends at lines normal to the pavement centerline, within a ground area. Ground areas shall be neat rectangular areas of uniform surface appearance.

The original of the final profilograms that indicate the pavement surface is within the Profile Index specified shall become the property of the County and shall be delivered to the Engineer prior to acceptance of the contract.

Method of Payment:

The contract bid price paid per ton for Hot mix Asphalt shall include full compensation for furnishing all labor, tools, materials, equipment, and incidentals, and for doing all the work involved including the furnishing and applying asphaltic emulsion (paint binder).

Asphalt Concrete for road pavement and asphalt concrete dike will be paid for at a unit price per ton as a combined item, including mineral aggregate and asphalt binder in place on the roadbed.

The placing of Asphalt Concrete dike shall be paid per linear foot, and the asphalt concrete material quantities used for dike will be paid at the contract price per ton for asphalt concrete.

At road connections and at limits of asphalt paving, existing pavement shall be header cut as shown on the plans or as directed by the Engineer. Full compensation for furnishing all labor, tools and

doing all the work necessary including grinding, and sawcutting shall be considered as included in the contract prices paid per ton for the various asphalt concrete items and no additional compensation will be allowed therefor.

COMPENSATION ADJUSTMENTS FOR PRICE INDEX FLUCTUATIONS:

The provisions of this section shall apply only to the following contract items:

ITEM CODE	ITEM
390130	Hot Mix Asphalt

The compensation payable for asphalt binder used in hot mix asphalt will be increased or decreased in conformance with the provisions of this section for paving asphalt price fluctuations exceeding 10 percent (I_u/I_b is greater than 1.10 or less than 0.90) which occur during performance of the work.

The adjustment in compensation will be determined in conformance with the following formulae when the item of asphalt concrete is included in a monthly estimate:

A. Total monthly adjustment = AQ

B. For an increase in paving asphalt price index exceeding 10 percent:

$$A = 0.90 (I_u/I_b - 1.10) I_b$$

C. For a decrease in paving asphalt price index exceeding 10 percent:

$$A = 0.90 (I_u/I_b - 0.90) I_b$$

D. Where:

A = Adjustment in dollars per ton of paving asphalt used to produce asphalt hot mix asphalt rounded to the nearest \$0.01.

I_u = The California Statewide Paving Asphalt Price Index which is in effect on the first business day of the month within the pay period in which the quantity subject to adjustment was included in the estimate.

I_b = The California Statewide Paving Asphalt Price Index for the month in which the bid opening for the project occurred.

Q = Quantity in tons of asphalt binder that was used in producing the quantity of hot mix asphalt shown under "This Estimate" on the monthly estimate using the amount of asphalt binder determined by the Engineer.

The adjustment in compensation will also be subject to the following:

- A. The compensation adjustments provided herein will be shown separately on payment estimates. The Contractor shall be liable to the State for decreased compensation adjustments and the Department may deduct the amount thereof from moneys due or that may become due the Contractor.
- B. Compensation adjustments made under this section will be taken into account in making adjustments in conformance with the provisions in Section 4-1.03B, "Increased or Decreased Quantities" of the Standard Specifications.
- C. In the event of an overrun of contract time, adjustment in compensation for paving asphalt included in estimates during the overrun period will be determined using the California Statewide Paving Asphalt Price Index in effect on the first business day of the month within the pay period in which the overrun began.

The California Statewide Paving Asphalt Price Index is determined each month on the first business day of the month by the Department using the median of posted prices in effect as posted by Chevron, Mobil, and Unocal for the Buena Vista, Huntington Beach, Kern River, Long Beach, Midway Sunset, and Wilmington fields.

In the event that the companies discontinue posting their prices for a field, the Department will determine an index from the remaining posted prices. The Department reserves the right to include in the index determination the posted prices of additional fields.

The California Statewide Paving Asphalt Price Index is available on the Division of Engineering Services website at: http://www.dot.ca.gov/hq/esc/oe/asphalt_index/astable.html.

FOG SEAL COAT OVER PARKING LOT:

A fog seal coat shall be applied over the parking lot in conformance with the provisions in Section 37, "Bituminous Seals" of the Standard Specifications.

Method of Payment:

Full compensation for furnishing all labor, tools, materials, equipment, and incidentals, and for doing all the work involved in the furnishing and applying fog seal coat over the parking lot shall be considered as included in the contract price paid per ton for Hot Mix Asphalt and no additional compensation shall be allowed therefor.

ASPHALT CONCRETE DIKE:

Asphalt concrete dikes shall be constructed in accordance to the plans, Standard Plans and Specifications, Riverside County Road Improvement Standards and Specifications, as specified and as directed by the Engineer.

The pay quantity of asphalt concrete dikes shall be for placement, and shall be paid for as a separate item of work in addition to the price paid for the asphalt concrete material.

The transition of AC dike shall be paid in the same manner as placement of AC dike.

The asphalt concrete shall be Type "A" and shall conform to the requirements of Section 39 of the Standard Specifications and aggregate grading shall be three-quarter inch (3/4") maximum.

Asphalt binder to be mixed with the aggregate shall be PG 70-10 in accordance with the Special Provision for Asphalt, or as directed by the Engineer.

For payment purposes, removal and disposal of existing asphalt concrete dike shall be considered as included in the contract bid price paid per cubic yard for Roadway Excavation. No additional compensation will be allowed.

Method of Payment:

The contract unit bid price paid per linear foot for Asphalt Concrete Dike shall include full compensation for furnishing all labor, material other than asphalt concrete, tools, and equipment and for doing all the work involved in placing and compacting the dikes, and no additional compensation will be allowed therefor.

MINOR CONCRETE CURB RAMPS, DRIVEWAY APPROACHES, CURBS, GUTTERS, SIDEWALKS, BUS PAD, AND BUS TURNOUT:

Concrete curb ramps, driveway approaches, curbs, gutters, sidewalks, bus pad, and bus turnout shall be constructed in accordance with the County of Riverside Road Improvement Standards and Specifications, in conformance with Sections 51, 73 and 90 of the Standard Specifications, as shown on the plans, and as directed by the Resident Engineer.

Class 2 concrete shall be used for Bus Pad and Bus Turnout.

Class 3 concrete shall be used curb ramps, driveway approaches, curbs, gutters, and sidewalks.

Construction of concrete improvements shall include all removal and restoration of the affected irrigation and landscaping, and related work, to return the area adjacent to the new improvements to its original condition and to conform the area to the new improvements.

The area behind and along the concrete improvements shall be filled and compacted with native or select material and graded to match and provide a smooth transition from the edge of the new improvements, to the satisfaction of the Engineer.

Preparation of subgrade for the concrete structures shall be done in conformance with the requirements of Section 73-1.02 of the Standard Specifications. Unless otherwise specified, all curbs and gutters will be backfilled as shown on the plans.

Excess material resulting from the excavation and/or removal of existing concrete curb, gutter, sidewalk, or ramp including the subgrade, as shown on the plans or as directed by the Resident Engineer, shall be disposed of as elsewhere provided in these Special Specifications.

Full compensation for all costs involved in disposing of materials as specified in this section, including all costs of hauling, shall be considered as included in the various Minor Concrete contract items of work and no additional compensation will be allowed therefor.

The Contractor is responsible for meeting requirements of all American with Disability Act (ADA).

Construction of curb ramps, driveway approaches, curbs, gutters, sidewalks, bus pad, and bus turnout shall include, but not be limited to, the following:

- 1) Removal and disposal of existing curb ramps, driveway approaches, curbs, gutters, sidewalks, bus pad, and bus turnout, and existing soil and aggregate as required;
- 2) Establishing grades, and assuring that all grades are met;
- 3) Performing all grading and compaction – including all required aggregate import, as directed by the Engineer and in accordance with County Standard 403;
- 4) Construction of new curb ramps, driveway approaches, curbs, gutters, sidewalks, bus pad, and bus turnout;
- 5) All scoring/grooving and required saw cutting;
- 6) Repair of existing asphalt and PCC surfacing;
- 7) Installing 1/2" wide expansion joints;
- 8) All landscaping, and related work, to return the area adjacent to the sidewalk, curb ramps, driveways, driveway approaches, curb and/or curb and gutter to its original condition and to conform the area to the new improvements;

At a minimum, the area from the BCR to ECR shall meet all required ADA standards. Therefore, to conform to existing conditions and/or to achieve the required four-foot level area (maximum of 2.0% crossfall) at the top portion of the curb ramp, it may be necessary to extend the work beyond the BCR/ECR in certain instances.

Full compensation for constructing or furnishing and installing curb ramp detectable warning surfaces shall be considered as included in the contract unit price paid for Minor Concrete (Curb Ramp) and no separate payment will be made therefor.

Construction of curb and gutter, signal conduits, sidewalk, driveways, median, and other improvements will require the removal of 2-sack slurry cement backfill material found at existing reinforced concrete box storm drains on Ontario Avenue/Temescal Canyon Road approximately between Sta 11+15 and Sta 12+00.

Full compensation for the necessary removal of 2-sack slurry cement backfill material encountered during excavation shall be considered as included in the contract bid price paid per cubic yard for Roadway Excavation and no additional compensation will be allowed therefor.

Method of Payment:

The contract unit bid prices paid per each for Minor Concrete (Curb Ramp); per linear foot for Minor Concrete (Curb and Gutter), and Minor Concrete (Type "D" Curb); and per square foot for Minor Concrete (Driveway Approach), Minor Concrete (Sidewalk), Minor Concrete (Bus Stop Pad), Minor Concrete (Bus Turnout); shall include full compensation for furnishing all labor, equipment, materials and tools, and incidentals, and for doing all the work involved in the construction and complete in place including the furnishing and placing of expansion joints.

MINOR CONCRETE COLORED STAMPED CONCRETE:

Colored stamped concrete shall be constructed in accordance with the plans and these specifications, or as directed by the Engineer and in conformance with Section 51, 52, 73 and 90 of Standard Specifications.

Class 3 concrete shall be used for the colored stamped concrete areas. Preparation of subgrade for the concrete structures shall be done in conformance with the requirements of Section 73-1.02 of the Standard Specifications.

The maximum size aggregate for the colored stamped concrete shall be 3/8 inch. Stamped concrete shall be imprinted with special tools while in the plastic stage to provide the pattern specific herein.

Pattern and Finish for the Colored Stamped Concrete:

Color:

Integral color shall be "Baja Red 160" by Davis Colors, or close approximation as approved by the Engineer. The listed product is intended as a guideline, and products from alternate manufacturers will be accepted provided that the product and color are close approximations as determined by the Engineer.

Pattern:

The stamped concrete pattern shall be "Ashler Stone – Random Interlocking Pattern, Order No. 400 A, B, or C" by Scofield Systems, or close approximation as approved by the Engineer. The listed product is intended as a guideline, and products from alternate manufacturers will be accepted provided that the product provides a pattern of the size and texture that is a close approximation to the guideline product.

The pattern shall be implanted, indented, imprinted or stamped into the surface by means of forms, molds, or other approved devices. The impressions shall be approximately 3/8 inch in width, and shall be ungrouted unless otherwise specified.

The Contractor shall install at least one test panel, in an area not to be incorporated into the work, for the specified color and pattern. The sample shall be a minimum of 16 square feet and 4 inches thick, which shall be subject to inspection and approval by the Engineer. If ordered by the Engineer, additional test panels shall be constructed and finished until a satisfactory representation is obtained. The approved test panel shall then be the standard of comparison for enhanced concrete paving. The Contractor shall dispose of the test panel when work is completed, unless otherwise directed by the Engineer.

The Contractor shall provide the Engineer with Certificates of Compliance for all materials used in the imprinting, texturing, coloring, curing, and sealing of decorative colored stamped concrete crossing paving installation, including: Product Name, Supplier, Product Type, and Date of Delivery.

All concrete slabs shall slope to drain. Depressions in the slab surface that hold water will not be accepted.

Expansion joints, joints fillers and joint sealants shall conform to Section 51-1.12 of the Standard Specifications. Joint filler shall be ½ inch wide, premolded, polyethylene expansion foam with a perforated removable top. Remove top of perforated foam filled expansion joint and apply uniform bead of sealant into the joint assuring complete wetting of the bonding surfaces. Thoroughly clean all joint surfaces and apply masking tape to all surfaces adjacent to joints to protect them from primer and sealant residue. Prime all expansion joints carefully. Do not apply primer to any adjacent surfaces.

The colored stamped concrete shall be protected against rapid drying and damage by rain. Keep moist for at least 7 days after placing and protect by wet burlap, canvas covering or liquid-curing compound. If weather is hot or surface has dried out, spray surface with fine mist of water, starting no later than 2 hours after final troweling. Wetting is considered emergency work and shall be performed on weekends and holidays if necessary.

A clear concrete sealer shall be applied between 14 days and 28 days after concrete placement, per manufacturer's written instructions and specifications. The sealed surface shall be finished using a fine brush, which removes residual dust from the surface.

No cutting removal or patching of work will be permitted to correct damaged or defective work; defective sections shall be removed and replaced. Repair of damaged facilities shall be performed by the Contractor within a reasonable amount of time. No extensions of time will be allowed for correcting defective work.

All colored stamped concrete construction shall be performed by qualified personnel. The Contractor shall provide written evidence demonstrating to the satisfaction of the Engineer that the installer has successfully performed concrete placement and finishing work similar to that specified herein. Such evidence shall include past project documentation and references.

Construction of colored stamped concrete shall include, but not be limited to, the following:

- 1) Removal and disposal of existing soil, asphalt and aggregate as required;
- 2) Furnishing and installing and compacting any fill material required under the stamped concrete;
- 3) Establishing grades, and assuring that all grades are met;
- 4) Performing all grading and compaction
- 5) Construction of new stamped colored concrete;
- 6) All scoring/grooving and required saw cutting;
- 7) Installing 1/2" wide expansion joints;
- 8) Reinforcing steel
- 9) Construction of the colored stamped concrete, including furnishing and incorporating color admixtures, furnishing and applying color hardeners, furnishing and placement of clear seal and other work as required herein,

Method of Payment:

Full compensation, except as otherwise provided herein, for conforming to the requirements of this article and plans, including furnishing all labor, tools, equipments, incidentals, furnishing and disposing 4-foot x 4-foot x 4-inch thick colored stamp concrete samples for the approval of the Resident Engineer and doing all the work involved in accordance with the contract documents shall be included in the unit price bid, per square foot for Minor Concrete (Stamped Concrete) and no additional compensation shall be allowed therefor.

UNDER SIDEWALK DRAIN:

Under sidewalk drain shall conform to the County of Riverside Road Improvement Standards and Specifications, and as directed by the Resident Engineer.

Method of Payment:

The contract unit bid price paid per each for Under Sidewalk Drain Cast in Place shall include full compensation for furnishing all labor, materials, tools, equipment, and complete in place and no additional compensation will be allowed therefor.

RELOCATE SIGN STRUCTURE:

The Contractor shall remove and relocate existing private sign (Alberto's restaurant) including foundation, to the location shown on the plans as directed by the Resident Engineer.

The sign shall be carefully removed, stored, and reinstalled. If the sign is damaged during the relocation operations, the Contractor shall replace the damaged sign at his own expense.

The Contractor shall reconnect the sign overhead electrical connection.

Method of Payment:

The contract price paid per each for Relocate Sign Structure shall include full compensation for furnishing all labor, materials, tools, equipment, and incidentals, and for doing all the work involved in removing and relocating the private sign as shown on the plans, and as specified in these special provisions, and as directed by the Engineer, including concrete footing, hardware, reconnecting the sign electrical connection, the removal and disposal of existing footing and resulting material.

REMOVE TRAFFIC STRIPE AND PAVEMENT MARKINGS:

Where blast cleaning/grinding is used for the removal of painted/thermoplastic traffic stripe and pavement marking or for removal of objectionable material, and such removal operation is being performed within 10 feet of a lane occupied by public traffic, the residue including dust shall be removed immediately after contact between the sand and the surface being treated. Such removal shall be by wet abrasive blasting, hydro-blasting or vacuum blasting, and shall comply with AQMD regulations.

Blast cleaning/grinding for removal of traffic stripe shall be feathered out to irregular and varying widths.

Pavement marking shall be removed by blast cleaning/grinding a rectangular area, rather than just lettering or markings, so the old message cannot be identified.

After removal of traffic stripes and pavement markings, a fog seal coat shall be applied in conformance with the provisions in Section 37, "Bituminous Seals" of the Standard Specifications and the following:

If removal of existing striping is performed more than 24 hours prior to final striping, the Contractor shall place reflective temporary striping tape throughout the limits of sandblasting, to provide channelization of traffic, for all lanes of travel.
Temporary striping tape shall be removed subsequent to final striping.

Nothing in these Special Provisions shall relieve the Contractor from his responsibilities as provided in Section 7-1.09, "Public Safety," of the Standard Specifications.

Method of Payment:

The price paid per square foot for Remove Traffic Stripe And Pavement Marking shall include full compensation for furnishing all labor, tools, materials, and equipment and no additional compensation will be allowed therefor.

THERMOPLASTIC STRIPE AND PAVEMENT MARKING:

Thermoplastic crosswalks and pavement markings shall conform to the provisions in Sections 84-1, "General," and 84-2, "Thermoplastic Traffic Stripes and Pavement Markings," of the Standard Specifications and these Special Provisions.

Newly painted pavement markings shall be protected from damage by public traffic or other causes until the thermoplastic is thoroughly dry. Any newly installed traffic markings which are damaged as a result of the construction, including wheel markings by public traffic and the construction equipment, shall be replaced by the Contractor and any associated removals shall be performed as called for in these Special Provisions.

Method of Payment:

The contract unit bid prices paid per square foot for Thermoplastic Stripe and Pavement Marking shall include full compensation for furnishing all labor, materials, tools, equipment, and incidentals and for doing all the work necessary and no additional compensation will be allowed therefor.

PAINT TRAFFIC STRIPE:

Painting traffic stripe shall conform to the provisions in Sections 84-1, "General", 84-3, "Painted Traffic Stripes and Pavement Markings" and 84-3.05, "Application" of the Standard Specifications and these Special Provisions.

Traffic striping shall be applied in two coats with airless equipment and shall be performed with a roadliner truck mounted striping machine. Where the configuration or location of a traffic stripe is such that the use of a roadliner truck mounted striping machine is unsuitable, traffic striping and glass spheres may be applied by other methods and equipment approved by the Engineer.

Newly painted traffic striping shall be protected from damage by public traffic or other causes until the paint is thoroughly dry. Any newly painted traffic striping which are damaged as a result of the construction, including wheel markings by public traffic and the construction equipment, shall be repainted by the Contractor and any associated removals shall be performed as called for in these Special Provisions.

The contract price paid per linear foot for Paint Traffic Stripe (2 Coats) shall include full compensation for furnishing all labor, materials, tools, equipment, and incidentals, and for doing all the work involved in painting traffic stripe (regardless of the number, widths, and types of individual stripes involved in each traffic stripe) including any necessary cat tracks, dribble lines any layout work, complete in place as shown on the plans, as specified in the Standard Specifications and these Special Provisions, and as directed by the Engineer.

REMOVE AND SALVAGE ROADSIDE SIGNS:

Existing roadside signs shall be removed and salvaged as shown on the plans.

Existing roadside signs at locations shown on the plans to be removed shall not be removed until replacement signs have been installed or until the existing signs are no longer required for direction of public traffic, unless otherwise directed by the Engineer.

The Contractor shall deliver County owned signs to be salvaged to the nearest County Maintenance Yard as directed by the Engineer.

Method of Payment:

The contract unit price paid per each for Remove Signs shall include full compensation for furnishing all labor, materials, tools, equipment and incidentals and for doing all the work including excavation and backfill as specified in the Standard Specification and these Special Provisions and no additional compensation will be allowed therefor.

RELOCATE SIGN:

Roadside signs (relocate) shall conform to the provisions in Section 56 of the Standard Specifications and as directed by the Engineer.

Existing roadside signs shall be removed and relocated to the new locations shown on the plans or where directed by the engineer.

Unless otherwise approved by the Engineer, each roadside sign shall be installed at the new location on the same day that the sign is removed from its original location.

All signs shall be installed using hex head bolts, washers, nuts and jam nuts in accordance with Standard Plans RS2 or as directed by the Engineer.

Method of Payment:

The contract unit price paid per each for Relocate Sign shall include full compensation for furnishing all labor, materials, tools, equipment, and incidentals and for doing all the work including all necessary concrete excavation and backfill as specified in the Standard Specification and these Special Provisions and no additional compensation will be allowed therefor.

ROADSIDE SIGN:

Roadside signs shall conform to the provisions in Section 56-2 "Roadside Signs" of the Standard Specifications and these special provisions.

The Contractor shall furnish and install roadside signs, in accordance with Standard Plans RS-2, at the locations shown on the plans or as directed by the Engineer.

Roadside signs with steel posts shall be installed at the location shown on the construction plans or where directed by the Engineer.

Roadside signs furnished by the Contractor shall be of the standard size specified in the State of California Department of Transportation Sign Specification Sheets, unless otherwise indicated on the construction plans.

Sheeting shall be guaranteed against defects for a period of ten years from the date of fabrication.

The base metal shall be new aluminum, 0.08 gauge, of alloys 6061-T6 or 5052-H38 conforming to the requirements of ASTM Designation: B209.

Any reflective sheeting supplied, as a part of this contract, whether as a legend or background, shall be FHWA FP-85 Type IIA or AASHTO M268 Type III.

Reflective sheeting shall be applied to the sign by a method approved by the manufacturer of the sheeting and shall produce a durable bond equal to or greater than the strength of the reflective sheeting. No air pockets or bubbles shall exist between the sheeting and aluminum backing.

The reflective material and screening inks or overlay film shall be graffiti proof. The graffiti proofing method shall be supplied by and/or approved by the sheeting manufacturer. Neither the color nor the reflective intensity of the finished sign shall be significantly diminished by the use of graffiti remover when used in a manner approved by the Transportation Department in conjunction with the sheeting manufacturer. Any sign graffiti with the use of over-the-counter spray paint or marking pens, which fail to be restored, shall be replaced by the sign sheeting manufacturer.

All letters and numerals shall be in accordance with the "Standard Alphabet of Highway Signs" as used by the State of California, Department of Transportation.

All signs shall be installed using hex head bolts, washers, nuts and jam nuts in accordance with Standard Plans RS2 or as directed by the Engineer.

Method of Payment:

The contract price paid per each for Roadside Sign-One Post and Install Sign (Strap and Saddle Bracket Method) shall include full compensation for furnishing all labor, materials, tools, equipment, incidentals and for doing all the work including excavation and backfill, and installation as specified in the Standard Specification and these Special Provisions and no additional compensation will be allowed therefor.

DELINEATORS

Delineators shall conform to the provisions in Section 82, "Markers and Delineators," of the Standard Specifications and these special provisions.

Flexible posts shall be made from a flexible white plastic which shall be resistant to impact, ultraviolet light, ozone, and hydrocarbons. Flexible posts shall resist stiffening with age and shall be free of burns, discoloration, contamination, and other objectionable marks or defects which affect appearance or serviceability.

Retroreflective sheeting for metal and flexible target plates shall be the retroreflective sheeting designated for channelizers, markers, and delineators conforming to the requirements in ASTM Designation: D 4956-95 .

Method of Payment:

The contract price paid per each Delineator (Class 1) shall include full compensation for furnishing all labor, materials, tools, equipment, incidentals and no additional compensation will be allowed therefor.

PAVEMENT MARKERS:

Pavement markers shall conform to the provisions in Section 85, "Pavement Markers" of the Standard Specifications and these Special Provisions.

Pavement markers shall be placed to the line established by the Engineer. All additional work necessary to establish satisfactory lines for markers shall be performed by the Contractor.

Pavement markers shall be installed where indicated on the plans in accordance with the indicated striping detail. Refer to Standard Plans A20-A through A20-D for striping and markings details.

Markers and adhesive removal shall be performed by a method approved by the Engineer. Any pavement scarring resulting from the markers removal shall be repaired to the satisfaction of the Engineer.

Method of Payment:

Payment for furnishing and placing Pavement Markers (Reflective) will be at the unit price bid and shall include full compensation for furnishing all labor, materials, tools, equipment and no additional compensation will be allowed therefor.

PARKING BUMPERS:

Parking bumpers shall be furnished and installed at the locations and in the manner shown on the plans, in conformance with Standard Plan A90A, these Special Provisions, and as directed by the Engineer.

Unless indicated otherwise, provide bumpers of 48-inch length.

Parking bumpers shall be precast with concrete and reinforced with two No. 4 deformed reinforcing bars, minimum.

Concrete shall be minor concrete conforming to the provisions in Section 90-10, "Minor Concrete," of the Standard Specifications. Concrete shall contain not less than 472 pounds of cementitious material per cubic yard. Parking bumpers may be commercially available precast concrete bumpers conforming to these specifications. Minor variations in cross section dimensions will be acceptable in commercially available units.

Each bumper to be installed on at-grade asphalt pavement shall be manufactured with two holes to accommodate the installation dowel.

Dowels shall be commercial quality reinforcing steel or mild steel rods. Precast parking bumpers shall be anchored and secured in position on at-grade asphalt pavement with two No. 5 epoxy-coated rebar and appropriate epoxy.

Adhesive for anchoring bumpers shall be an epoxy adhesive manufactured for the purpose, similar and equal to the adhesives specified in Section 95-2.04 or 95-2.05.

Parking bumpers will be measured by the unit as determined from actual count in place.

Method of Payment:

The contract unit price paid per each for Parking Bumper (Precast Concrete) shall include full compensation for furnishing all labor, materials, tools, equipment, and incidentals, and for doing all the work involved in installing precast concrete parking bumpers, complete in place, as shown on the plans, as specified in the Standard Specifications and these special provisions and as directed by the Engineer.

STEEL GUARD POST (CONCRETE FILLED):

Guard posts shall be furnished and installed at the locations and in the manner shown on the plans, in conformance with Standard Plan ES-7Q, these Special Provisions, and as directed by the Engineer.

Method of Payment:

Full compensation for conforming to the requirements of this article including all labor, equipment, materials and incidentals, to install concrete filled steel guard posts as shown on the plans or as directed by the Engineer, shall be included in the contract unit prices paid per each for Guard Post and no additional compensation will be allowed therefor.

REMOVE CHAIN LINK :

Existing fence shall be removed as shown on the plans and as directed by the Engineer, and disposed of in conformance with the provisions in Section 7-1.13, "Disposal of Material Outside the Highway Right of Way" of the Standard Specifications.

Trimming the existing chain link fence mesh and leaving it in place will not be allowed.

Ground disturbance, including holes and depressions, caused by the removal of the chain link fence shall be backfilled and repaired in conformance with the provisions in Section 15-1.02, "Preservation of Property" of the Standard Specifications.

Method of Payment:

The contract unit bid price paid per linear foot for Remove Chain Link Fence shall include full compensation for furnishing all labor, materials, tools, equipment, and incidentals and for doing all the work involved and no additional compensation will be allowed therefor.

CHAIN LINK FENCE AND PEDESTRIAN GATE:

Chain link fence shall be Type CL-6 and shall conform to the provisions in Section 80, "Fences", and Section 80-4, "Chain Link Fence", of the Standard Specifications.

Method of Payment:

The contract unit bid price paid per linear foot for Chain Link Fence (Type CL-6) shall include full compensation for furnishing all labor, equipment, materials and tools, and incidentals, and for doing all the work involved including the furnishing and installation of the Pedestrian Gate, any excavation and backfill with concrete and no additional compensation will be allowed therefor.

ROOT BARRIER:

Root barrier work shall consist of providing and installing 100 linear feet of root barrier along the leach bed field perimeter to prevent root intrusion as directed by the resident engineer.

The root barrier shall be "**UB 36-2**" by DeepRoot, or close approximation as approved by the Engineer. The listed product is intended as a guideline, and products from alternate manufacturers will be accepted provided that the product provides a pattern of the size and texture that is a close approximation to the guideline product.

Root barriers shall be an injection molded or extruded modular component made of high-density polypropylene or polyethylene plastic. Panels shall have a minimum thickness of 1/16 inch. Each panel shall have molded vertical ribs (four minimum) and locking strips or integral male/female sliding locks. Vertical root-deflecting ribs or channels shall be between 0.5 inch and 0.8 inch high, perpendicular to the panel, and between 6 inches and 8 inches apart. Panels shall be a minimum of **2 feet wide x 3 feet deep**.

Panels shall be installed 0.5 inch above finished grade and joined with locking strips or integral male/female sliding locks. Locking mechanism shall have a close tolerance to restrict slippage between panels. Barriers shall be installed with root deflectors facing outward.

Root barriers shall be measured by the total length of panels installed in the field, measured parallel to the ground surface.

Method of Payment:

The contract unit price paid per linear foot for root barriers shall include full compensation for furnishing all labor, materials, tools, equipment, and incidentals, and for doing all the work involved in installing root barriers, complete in place, as shown on the plans, as specified in the Standard Specifications and these special provisions, and as directed by the Engineer.

ONSITE WASTEWATER TREATMENT SYSTEM:

The Contractor installing the onsite wastewater treatment system (OWTS) is required to have a C42 license, Sanitation System Contractor license.

Work under this section involves abandonment of existing septic system and grease interceptor, furnishing and installing 1,200 gal commercial septic tank (traffic rated), 750 gal grease interceptor, and leach bed as specified in these Special Provisions, as shown on the plans and as directed by the Engineer.

The work includes all services, labor, materials, transportation and equipment necessary to perform the work indicated on the plans, as specified in these Special Provisions, and as directed by the Engineer.

All work will be inspected and approved by the Engineer and the County of Riverside Environmental Health Department.

Existing septic system and grease interceptor abandonment:

1. Existing tanks shall be pumped and cleared of all waste.
2. Tank bases shall be broken or cored to enable drainage. Perforations shall consist of 4 holes each consisting of at least 0.5 square feet.
3. Tops and walls shall be removed as required to facilitate any planned subsurface trenching or construction.
4. The tanks should be backfilled with approved native or imported soil compacted to at least 90% relative compaction or with sand-cement slurry having one-sack of cement per cubic yard.
5. The remainder of the excavation shall be backfilled with native or approved imported soil compacted to at least 90% relative compaction. Compaction of the upper 12 inches within planter areas may be waived upon approval of the Resident Engineer.

Septic Tank and Grease Interceptor:

1. Area must be prepared and cleared to 2 feet minimum surrounding entire tank.
2. The excavation's slope, benching or shoring shall comply with the requirements of OSHA 29 CFR 1926 Sub Part P.
3. Base must be level and even in all directions.
4. The excavation shall be bedded with suitable granular material and shall be compacted to 90% of the maximum dry density or to the requirements of the Resident Engineer.
5. Minimum setback for septic tank or grease interceptor is 5 feet from the building or property line.

Leach Bed Construction:

Clearing: Clearing should be limited to mowing and raking because the surface should be only minimally disturbed. Trees should be cut at the base of the trunk and removed without heavy machinery and the stumps ground out.

Excavation: To avoid potential soil damage during construction, the moisture content of the soil below the proposed infiltration surface elevation must be below the plastic limit. This

should be tested before excavation begins. Excavation should be scheduled only when the infiltration surface can be covered the same day. All efforts should be made to avoid any disturbance to the exposed infiltration surface. Equipment should be kept off the infiltration field. Before the gravel is placed, any smeared areas should be scarified and the surface gently raked. The infiltration surface shall be inspected prior to placement of gravel.

Root Barrier: Root barrier shall be installed as specified in the 'Root Barrier' section of these Special Provisions, as shown on the plans and as directed by the Resident Engineer.

Gravel: Gravel shall consist of clean 3/4" to 2-1/2" rock that is durable, resistant to slaking and dissolution, and free of fine particles. Gravel should be placed in the leachbed by using the backhoe bucket rather than dumping it directly from the truck. The gravel shall extend at least 12 inches below 4 inches above the distribution pipes. The gravel shall be covered with geotextile or untreated building paper prior to the placement or soil backfill.

Perforated Pipe: 4 inch diameter perforated plastic pipe is the most commonly used distribution piping for gravity flow systems. The piping shall be smooth-walled rigid polyvinyl chloride (PVC) or Acrylonitrile-butadiene-styrene (ABS) perforated with two rows of holes or slots spaced 12 inches on center. The piping shall be laid level in gravel with the holes or slots at the bottom as depicted on the plans. The piping shall be inspected prior to placing cover.

Backfilling: Before leaving the site, the area around the site should be graded to divert surface runoff from the leachbed area. The backfill over the infiltration surface should be mounded slightly to account for settling and eliminate depressions over the system that enable ponded water. The area should be covered with 3" layer or 3/4" rock over a breathable fabric or weed mat.

Distribution Box: The structure shall be a Jenson Precast D 30 with a single inlet or approved equal. Individual outlets at the same elevation for each distribution line. An above grade cover allows access to the inside of the box. The "D-Box" must be laid level on a sound, frost-proof footing.

Method of Payment:

The contract price paid per lump sum for Onsite Wastewater Treatment System [Including Abandonment of Existing Septic System and Grease Interceptor, Furnishing and Installing 1,200 gal Commercial Septic Tank (Traffic Rated), 750 gal Grease Interceptor, and Leach Bed] shall include full compensation for furnishing all labor, tools, materials, equipment and incidentals, and for doing all the work involved in installing Onsite Wastewater Treatment System complete in place, as shown on the plans, as specified in these Special Provisions, and as directed by the Engineer, and no additional compensation will be allowed therefor.

Full compensation for the material needed to complete the work under this section including but not limited to 1,200 gal. septic tank, 750 gal. grease interceptor, all pipe and fittings, risers to grade (grade rings), cast iron rings and lids, distribution box, 3/4" to 2-1/2" rock, and effluent filters shall be considered as included in the contract price paid per lump sum for Onsite Wastewater Treatment System and no additional compensation will be allowed therefor.

MISCELLANEOUS DIRECTED WORK:

Miscellaneous directed work shall consist of necessary work that is not included in other contract bid items, as determined by the Engineer. Miscellaneous directed work shall be performed as directed by the Engineer and in accordance with the applicable standards and specifications.

Method of Payment:

Payment for implementing miscellaneous directed work will be paid for on a force account basis, in accordance with Section 9-1.03 of the Standard Specifications, up to the fixed bid price, for the work performed.

DE-MOBILIZATION:

De-mobilization shall consist of the completion of all final construction, cleanup work, incidentals to the project site(s), and administrative work required to secure the project for termination and acceptance by the Engineer, including, but not limited to the following:

1. Satisfactory completion of Finishing Roadway in accordance with Section 22 "Finishing Roadway" of the Standard Specifications.
2. Removal of all temporary facilities, temporary utilities, plant, equipment, surplus material, construction debris and similar from project limits and adjacent property, as required and as directed by the Engineer.
3. Restoration of all temporary roads and haul routes and construction storage and office areas, etc. to original or better condition.
4. Completion of record of drawings (as-builts), to the satisfaction of the Engineer.
5. Submission of final certified payroll documents to the Engineer.
6. Submission of property owner releases, as required by the Engineer.
7. Completion of the requirements of permits issued by other agencies.
8. Satisfactory completion of punch list items, all construction and administrative items of work.

De-Mobilization shall include the satisfactory completion of all items of work, but shall not be interpreted as being a separate payment for work that is paid under separate contract items. The contract item for De-Mobilization is intended for project close-out activities.

Method of Payment:

Payment for De-Mobilization will be made on a lump-sum basis in the amount of the fixed bid price after satisfactory completion of the above listed items. Payment for De-Mobilization will be included in the final pay estimate and payment. No partial payments will be made for De-Mobilization.

SIGNAL AND LIGHTING

A. General

Furnishing and installing traffic signal and highway lighting systems, and payment shall conform to the provisions in Section 86, "Signals, Lighting and Electrical Systems", of the latest edition Standard Specifications, amendments to the Standard Specifications, and these Special Provisions.

B. Start of Work

Location where signalization and highway lighting work is to be performed:

	Location	Area
1.	Ontario Ave / Temescal Cyn & El Cerrito Rd / Minnesota Rd	City of Corona

C. County Furnished Equipment

County furnished equipment shall conform to the provisions in Section 6-1.02, "State Furnished Materials", of the Standard Specifications and these Special Provisions.

The County of Riverside will furnish the following equipment and materials to the Contractor for installation:

1. Signal and Lighting Standards and Anchor Bolts
2. 10' Galvanized Steel IISNS Mast Arms

The Contractor shall pick up County furnished equipment and materials from the following location(s), or as directed by the Engineer, and transport them to the project site(s):

Traffic Signal Shop
Riverside County Transportation Department
McKenzie Highway Operations Center
2950 Washington Street
Riverside, California 92504
Telephone (951) 955-6894

Any County furnished equipment that is damaged after the Contractor has taken possession of the items shall be repaired to the satisfaction of the Engineer. If the damaged equipment is considered irreparable, it shall be replaced meeting the requirements stated in the Standard Specifications and these special provisions at the Contractor's cost.

D. Equipment Orders

The Contractor shall furnish all equipment and materials specified in plans and these special provisions that are not furnished by the County. All equipment shall be new and purchased by the Contractor for this project only.

The Contractor shall furnish the Engineer written statements from vendors stating that they have accepted the order for the said equipment within twenty-one (21) calendar days of the date that the County of Riverside Board of Supervisors awarded this contract. Delay in equipment delivering shall not be considered as justification for the suspension of the construction contract.

In addition to the liquidated damages set forth in Section 4 of these contract documents, the Contractor shall pay to the County of Riverside the sum of \$XXX same as project LD per day for each and every calendar day delay in receiving all of the below listed equipment, onto the job site or the contractors storage facility, and available for installation, within sixty (60) calendar days if standards/ posts, anchor bolts and IISNS mast arms were furnished by the County; otherwise, one hundred (100) calendar days of the contract award:

1. Traffic Signal Controller Assemblies
2. Service Equipment Enclosures
3. Traffic Signal and Pedestrian Signal Heads
4. LED Modules
5. Edge-Lit Internally Illuminated Street Name Signs and Mounting Brackets

E. Equipment List and Drawings

Equipment list and drawings shall conform to the provisions in Section 86-1.04, "Equipment List and Drawings", of the Standard Specifications and these Special Provisions.

The Contractor shall furnish four complete cabinet wiring diagrams for each furnished controller assembly, battery backup system, video detection system, and emergency vehicle preemption system. The cabinet wiring diagram shall include an approximately 6 inches x 8 inches or larger schematic drawing of the project intersection and on a separate 8 ½" x 11" sheet of paper, which shall include the following information, at a minimum:

1. North arrow
2. Street names
3. Pavement delineation and markings
4. Signal poles
5. Traffic signal heads with phase designations
6. Pedestrian signal heads with phase designations
7. Loop detectors with input file designations

F. Warranties, Guaranties, Instruction Sheets, and Manuals

Warranties, guaranties and instruction sheets shall conform to these Special Provisions.

- a. LED modules shall have five (5) years of manufacturer warranty.
- b. Battery Backup System (BBS) shall have five (5) years of manufacturer warranty. The first three (3) years shall be termed the "Advanced Replacement Program". Under this program, the manufacturer will send out a replacement within two business days of the call notifying them of an issue. The replacement unit may be either a new unit or a re-manufactured unit that is up to the latest revision. The last two years of the warranty will be factory-repair warranty for parts and labor on the BBS.
- c. Video Detection System shall have three (3) years of manufacturer warranty. During the warranty period, technical support from factory-certified personnel or factory-certified installers shall be available via telephone within four (4) hours of the time when a service call is made.
- d. Edge Lit LED internally illuminated street name sign shall have two (2) year of manufacturer warranty.
- e. All other equipment and systems shall have at least one (1) year of manufacturer warranty.

Furnish the manufacturer's standard written warranty pertaining to defects in materials and workmanship for all equipment, and two (2) sets of user, operation, and maintenance manuals, written in English, on all equipments and components for the traffic signal and highway lighting system to the Engineer.

G. Maintaining Existing and Temporary Electrical Systems

Maintaining existing and temporary electrical systems shall conform to the provisions in Section 86-1.06 "Maintaining Existing and Temporary Electrical Systems", of the Standard Specifications and these Special Provisions.

Authorization and coordination from the Engineer is required for each traffic signal system shutdown. Traffic signal system shutdowns shall be limited to periods between the hours of 9:00 A.M. and 3:00 P.M.

The Contractor may request authorization from the Engineer to use temporary overhead conductors for temporary traffic signal operation.

Equip existing flashing beacons with portable flashing beacons during flashing beacon shutdown. Portable flashing beacons shall conform to the provisions in Section 12-3.05, "Portable Flashing Beacons" of the Standard Specifications or as directed by the Engineer.

If directed by the Engineer, a generator shall be furnished, connected, and maintained to keep traffic signal or flashing beacon system running in normal operation. All matters pertaining to the operation

of existing traffic signal equipment shall be coordinated and cooperated with Riverside County's traffic signal operation division.

Temporary "Stop" signs furnished and installed shall be 48 inches in size.

Temporary "Stop Ahead" signs furnished and installed shall be equipped with portable flashing beacons.

H. Foundations

Foundations shall conform to the provisions in Section 51, "Concrete Structures", and Section 86-2.03, "Foundations", of the Standard Specifications and these Special Provisions.

Portland cement concrete shall conform to Section 90-10, "Minor Concrete", of the Standard Specifications and shall be Class 3 except pole foundations shall be Class 2.

Construct Type 332 controller cabinet foundation per Standard Plans ES-3C.

Vibrate all foundation concrete to eliminate air pockets.

I. Standards, Steel Pedestals and Posts

Standards, steel pedestals, and posts shall conform to the provisions in Section 86-2.04, "Standards, Steel Pedestals and Posts", of the Standard Specifications and these Special Provisions.

Type 1A pole material shall be spun aluminum unless otherwise specified.

Poles installed at the near-right approach of each intersection shall be banded conforming to the strap and saddle method per Standard Plans RS4 for the emergency installation of stop signs.

Signal mast arms shall be installed in accordance with the "Signal Arm Connection Details" of the Standard Plans unless otherwise specified.

Internally Illuminated Street name sign (IISNS) mast arm shall be 10 foot long galvanized steel mast arm constructed to prevent deformation or failure when subjected to 100 mph wind loads. IISNS mast arm shall extend from the shaft of the pole above and parallel to the signal mast arm in accordance with County Standard No. 1200. Two set-bolt /set-screw shall be used to assure the mast arm will not change position after it is installed and aligned.

If required by the serving electric utility, and confirmed by the Engineer, State Certified Electric Workers shall be utilized for the installation of standards, steel pedestals, and posts in accordance with State of California High Voltage Safety Orders.

J. Conduits

Conduit shall conform to the provisions in Section 86-2.05, "Conduit", of the Standard Specifications and these Special Provisions.

Conduits shall be Type 3, Schedule 80 Polyvinyl Chloride (PVC) conforming to requirements in UL Publication 651 for Rigid Non-Metallic Conduit, for underground installation only.

Conduit depth shall not exceed 60 inches below finish grade.

Conduit size shall be 2 inches minimum unless otherwise specified. New conduit shall not pass through foundations or standards.

Conduit bends shall be factory bends. Bend radius for signal interconnect conduits shall be 3 feet minimum.

A pull rope and a bare #12 AWG wire shall be installed in conduits intended for future use.

Bell bushings are required for all conduit ends. The ends of conduits terminating in pull boxes and controller cabinets shall be sealed with sealing compound approved by the Engineer after conductors have been installed.

Conduits shall be installed via jacking or drilling method per Section 86-2.05C, "Installation", of the Standard Specifications.

Pot-holing shall be performed prior to all conduit installation to determine utility underground location, including service laterals, to avoid damage to utility owner facilities.

Trenching Installation

The Engineer shall approve trenching installation on a case-by-case basis where conduit cannot be installed by jacking or drilling. Jacking or Drilling shall be attempted a minimum of three times prior to requesting trenching installation.

If ordered by the Engineer, all pavements shall be cut to a depth of 3 inches with an abrasive type saw or with a rock cutting excavator specifically designed for this purpose. Cuts shall be neat and true with no shatter surface outside the removal area.

Trench shall be 2 inches wider than the outside diameter of the conduit being installed however not exceeding 6 inches in total width. The conduit shall be placed in the bottom of the trench. Conduit depth shall be at a minimum of 30 inches below finished grade, with a minimum of 26 inches cover over the conduit.

The trench shall be backfilled with two-sack slurry to the finish grade before final paving. Prior to final paving, grind pavement centered along the length of the trench a minimum width of 3 feet and depth of 0.10 feet, and excavate backfilled to a depth of 0.30 feet below the final pavement surface. Final paving with commercial Type A ½" PG64-10 asphalt concrete.

If directed by the Engineer, the two-sack slurry backfill can be installed to a depth of 0.30 feet below the final pavement surface and cured for a minimum of two days prior to final paving if the trench area is not open to traffic.

K. Pull Boxes

Pull boxes shall conform to the provisions in Section 86-2.06, "Pull Boxes", of the Standard Specifications and these Special Provisions.

Traffic pull boxes shall conform to the provisions in Section 86-2.07, "Traffic Pull Boxes", of the Standard Specifications and these Special Provisions.

Pull boxes shall have a "Fibrelyte" or equivalent cover and bolt down design. Cover shall have a non-skid surface.

Pull box covers shall be marked in accordance with Standard Plans ES-8 without the word "CALTRANS" unless the project is on State of California right of way.

Pull boxes shall be placed with their tops flush with surrounding finish grade or as directed by the Engineer.

Pull boxes shall be installed behind the curb or as shown on the plans and shall be spaced at no more than 500 feet intervals. The Engineer shall determine the exact locations.

Pull boxes installed in unimproved areas, locations not protected by concrete curb and gutter, shall be traffic pull box and marked with Type L markers.

L. Conductors and Wiring

Conductors shall conform to the provisions in Section 86-2.08, "Conductors", of the Standard Specifications and these Special Provisions.

Wiring shall conform to the provisions in Section 86-2.09, "Wiring", of the Standard Specifications and these Special Provisions.

Specific cabling and wiring requirements for various systems or components shall be in accordance with the Special Provisions entitled to each herein.

Signal cable shall be installed continuously without splicing from the controller cabinet to each traffic signal pole. Traffic signal conductors, multiple circuit conductors, and signal cable conductors shall not be spliced unless otherwise shown.

All outer cable jacket for 12 conductor cable shall be removed from the traffic signal standard hand hole to the terminal block located at the side mount traffic signal head.

Where splice is required, Type C or Type T splice shall be used and insulated as shown in the Standard Plans, ES-13A.

Where splice is required, "Liquid Electrical Tape" or equivalent in black color shall be used to provide a watertight electrical insulating coating with "Method B" as shown in the Standard Plans, ES-13A.

Minimum luminaire wiring shall be No. 10 AWG, including wiring within poles and mast arms.

M. Blank

N. Bonding and Grounding

Bonding and grounding shall conform to the provisions in Section 86-2.10, "Bonding and Grounding", of the Standard Specifications and these Special Provisions.

Grounding jumper shall be attached by a 3/16 inch or larger brass bolt in the signal standard or controller pedestal and shall be run to the conduit, ground rod or bonding wire in the adjacent pull box.

Grounding jumper shall be visible after cap has been poured on foundation.

For equipment grounding jumper a No. 8 bare copper wire shall run continuously in all circuits except a No. 12 bare copper wire shall run continuously in conduits that contain only signal interconnect cable and/or loop detector cable.

O. Service

Service shall conform to the provisions in Section 86-2.11, "Service", of the Standard Specifications and these Special Provisions.

Service equipment enclosure shall be Type III-CF, as shown on the Standard Plans, ES-2F, and shall conform to the following:

1. 120 / 240 volt, 2 meter service unless otherwise shown on the plans.
2. Circuit breakers required:
 - 2 - 100 Amp 2 pole (signal main and lighting main)
 - 1 - 30 Amp 1 pole (luminaires)
 - 1 - 20 Amp 1 pole (illuminated street name signs)
 - 1 - 30 Amp 1 pole (signals)
 - 1 - 15 Amp 1 pole (luminaire photoelectric control)
 - 1 - 15 Amp 1 pole (street name sign photoelectric control)
 - 1 - 15 Amp 1 pole (for video detection cameras)
 - 1 - 20 Amp 1 pole (for each beacon, if applicable)

3. Cabinet shall be fabricated from aluminum sheeting and finish shall be anodic coating in accordance with Section 86-3.04A "Cabinet Construction".
4. Circuit breakers shall be marked with identifying labels for each circuit breaker.

Type V photoelectric control contactor and test switch assembly shall be installed in the service cabinet. Photoelectric control contactors shall be as follows:

1. Luminaires - 60 Amp electrically held contact
2. Street name signs - 30 Amp electrically held contact

A GFCI outlet shall be installed on the interior side of service cabinet door and an eight (8) position terminal strip for termination of Video Cameras.

Photo Electric Control assembly shall be installed within the circuit breaker compartment of the service equipment enclosure, and accessible to the County after installation of electrical meters.

Direct burial service conductors are not allowed.

The Contractor shall be responsible for contacting the power company, arranging and providing for the electrical service connection, and ensuring that adequate notice is provided to the serving electric company in advance of need. *The County of Riverside will pay all electric company fees required.*

The service equipment enclosure shall be a minimum of 15 feet from the controller cabinet, and a minimum of 10 feet from all utility poles, unless otherwise directed by the Engineer.

Service Identification

The service address shall be shown on the front upper panel of the service equipment enclosure, and the meters shall be labeled "LS3" (lighting meter) and "TC1" (signal meter) by lettering applied to the exterior of the enclosure in accordance with these special provisions, or as directed by the Engineer.

Lettering markings shall be black with a two-inch minimum size in block letter form. Markings shall be applied to a brushed aluminum, stainless steel, or other non-corroding metallic plate, as approved by the Engineer. Plate shall be white in color. All paint and markings shall conform in all respects to Federal Specification TT-E-489, latest revision, Class A, Air Drying. Said plate shall be affixed in a permanent manner by riveting or with stainless steel bolts and nuts. Bolts shall be peened after tightening. All materials used for affixing address plate shall be non-corroding. The Engineer shall approve all alternate materials and methods prior to installation.

P. Testing

Testing and Field Testing shall conform to the provisions in Section 86-2.14, "Testing", of the Standard Specifications and these Special Provisions.

Specific testing requirements for various systems and components shall be in accordance with the Special Provisions entitled to each herein.

The complete controller assembly and Battery Backup System shall be delivered to the following location or location as directed by the Engineer for testing:

Traffic Signal Shop
Riverside County Transportation Department
McKenzie Highway Operations Center
2950 Washington Street
Riverside, California 92504
Telephone (951) 955-6894

A minimum of 15 working days for operational testing and adjustment is required. An additional 15 working days period shall be allowed for retesting should the equipment fail.

The conflict monitor unit shall be tested in the field before signal turn on.

Q. Controller Assembly

Controller assembly shall conform to the provisions in Section 86-3, "Controller Assemblies", of the Standard Specifications and these Special Provisions.

Controller assembly shall be Model 170 controller assembly consisting of the additional features:

1. Model 332L controller cabinet:
 - Anodic coating for both interior and exterior finish
 - A Corbin No. 2 door lock
2. An interior fluorescent lamp with an on/off switch and a door switch that will automatically turn on the lamp when cabinet door is opened.
3. A interior thermostatically controlled, 24 volt electric fan with ball or roller bearing that has capacity rating of 100 cubic feet per minute minimum.
4. Rack mounted push buttons for manual actuation of the following:
 - 8 vehicular phases,
 - 4 pedestrian phases,
 - 4 Emergency Vehicle Preemption (EVP) phases; and,
 - 2 Railroad preemption phases.
5. Model 170E local controller unit:
 - Dual Asynchronous Communications Interface Adaptor (ACIA) capability. ACIA shall be integral to the controller unit. Horizontal printed circuit board controllers will not be accepted.
 - A Model 412F Program Module with 32K 27256 EPROM, 16K RAM, and 8K zero power RAM (memory method two, memory select four).
 - Bitrans Systems, Inc. 233RV2.5 or latest version firmware, test program and a loopback cable.

6. If required, provide a Model 170E field master controller unit that has the same features as the 170E local controller except the firmware shall be Bitrans Systems, Inc. No. 245 FM. It shall be mounted above the local controller unit.
7. A pullout shelf/drawer assembly made of aluminum with telescoping drawer guides for full extension installed below the local controller unit. The top shall have a non-slip plastic laminate permanently attached. The non-slip laminate shall not be attached with silicon adhesive.

8. Load Switches:

Switching circuit shall be contained in a replacement module (cube type) sealed in epoxy and rated at 15 amperes load (25 Amp triac). Pin 11 on all load switch sockets shall be wired to AC. Input and output indicators shall be installed on all load switches.

All load switch sockets shall have individual wire terminals. Printed circuit boards will not be allowed.

9. Flasher units:

Switching circuit shall be contained in a replacement module (cube type) sealed in epoxy and rated at 15 amperes load (25 Amps triac).

10. Conflict monitor shall be EDI Model 2010ECL or equivalent with a red monitor assembly circuit board and capable of monitoring green, amber and red indications.

11. Loop detector sensor unit shall be Model 222:

- Detector unit shall have delay timers adjustable from zero to a minimum of 30 seconds and extension timers adjustable from zero to a minimum of 7 seconds.
- Delay timers shall delay calls only during display of the associated red or yellow indications. If a vehicle departs the area of detection prior to expiration of the assigned delay period, the timer shall reset and no call shall be placed upon the controller. During display of the associated green indication, detectors shall operate in the present mode and calls shall not be delayed.

12. Power Distribution Assembly shall be Model PDA-2.

13. A twelve-position interconnect terminal strip.

The contractor shall furnish the following spare equipments / components:

Description	Model	Quantity
Cabinet	332	0
Controller Unit (local)	170E	0

Controller Unit (master)	170E	0
Switch Pack	200	0
Flasher Unit	204	0
Conflict Monitor Unit	2010	0
2-Channel Loop Detector	222	0
2-Channel DC Isolator	242	0
Modem Module	400	0
Program Module	412F	0

Spare equipments or components shall be delivered to the following location or as directed by the Engineer:

Traffic Signal Shop
Riverside County Transportation Department
McKenzie Highway Operations Center
2950 Washington Street
Riverside, California 92504
Telephone (951) 955-6894

The controller unit and controller cabinet shall be manufactured and furnished by the same manufacturer to form a complete functional controller system capable of providing the traffic signal operation specified. All traffic control equipment to be furnished shall be listed on the California Department of Transportation Qualified Products List.

The controller unit and controller cabinet manufacturer or supplier shall perform operational and functional testing of the supplied controller assembly and additional supplied equipment in accordance with the State of California Department of Transportation's Transportation Electrical Equipment specifications (TEES), and a Certificate of Compliance shall be issued for each successfully tested controller assembly and additional supplied equipment.

Modify traffic signal controller assembly if necessary and provide any necessary auxiliary equipment and cabling to achieve the intended traffic signal operation as shown on the plans. The Contractor shall make all field wiring connections to the terminal blocks inside the controller cabinet.

A technician who is qualified to work on the controller assembly from the controller manufacturer or their representative shall install the program module and program the signal controller in accordance with County the Engineer provided signal timing sheets, and to be present when the equipment is turned on.

R. Vehicle Signal Assemblies

Vehicle signal assemblies and auxiliary equipment shall conform to the provisions in Section 86-4.01 "Vehicle Signal Faces", Section 86-4.01B (1), "Metal Signal Sections", Section 86-4.01D "Visors",

Section 86-4.04, "Backplates", and Section 86-4.08 "Signal Mounting Assemblies" of the Standard Specifications and these Special Provisions.

Signal sections, backplates, visors and signal mounting assemblies shall be the metal type and shall be made from the same manufacturer. The section assemblies shall be uniform in appearance and alignment.

Backplates shall be louvered. Visors shall be the "tunnel" type. Top opening of signal sections shall be sealed with neoprene gaskets.

Vehicle signal indications shall be 12-inch diameter Light Emitting Diode (LED) modules in accordance with the following:

1. All circular LED modules shall comply with Institute of Transportation Engineers (ITE) Vehicle Traffic Control Signal Heads (VETCH) - LED Circular Supplement, Adopted June 27, 2005.
2. All arrow LED modules shall comply with ITE VETCH - LED Vehicle Arrow Traffic Signal Supplement, Adopted July 1, 2007.
3. All modules shall fit in existing signal housings without the use of special tools.
4. All modules shall be certified in the Intertek LED Traffic Signal Modules Certification Program and be labeled with the ETL Verified Label as follows:



5. Luminous intensity requirements of the VTCSH must be met across the entire temperature range from -40°C to +74°C, (-40°F to +165°F).
6. The following cable colors shall be used for the AC power leads on all modules: white for common, red for the red module line, yellow for the yellow module line, and brown for the green module line.
7. The AC power leads shall exit the module via a rubber grommet strain relief, and shall be terminated with quick connect terminals with spade tab adapters. The leads shall be separate at the point at which they leave the module.
8. All external wiring used in the module shall be anti-capillary type cable to prevent the wicking of moisture to the interior of the module.
9. All power supplies shall be coated for additional moisture and thermal protection.

10. The module shall have an incandescent, non-pixelated appearance when illuminated.
11. Nominal power usage is measured at 25°C, 120 VAC. For the 8 inch modules, it shall not exceed 8 watts for Red, 8 watts for Yellow, and 8 watts for Green modules. For the 12 inch modules, it shall not exceed 10 watts for Red, 19 watts for Yellow, and 11 watts for Green modules. For the arrows, it shall not exceed 6 watts for any color.
12. All modules shall use LEDs that have been manufactured with materials that have industry acceptance as being suitable for uses in outdoor applications. At no time is the use of LEDs that utilize AlGaAs technology acceptable.
13. The external lens shall have a smooth outer surface to prevent the buildup of dirt and dust and shall be designed to minimize the potential for sun phantom signals.
14. The circular LED module lens material must be tinted. A tinted transparent film or coating is not permitted.
15. A module shall be sealed against dust and moisture intrusion, including rain and blowing rain per Mil-Std-810F Method 506.4, Procedure 1.
16. Arrow modules shall be clearly marked with the phrase "Suitable for mounting in any orientation".
17. Modules shall be repaired or replaced if the module fails to function as intended due to workmanship or material defects within warranty period.
18. Modules shall be repaired or replaced if the module exhibit luminous intensities less than the minimum specified values within 60 months of the date of delivery.
19. The Manufacturer shall clearly disclose the country in which the factory of module origin is located, the name of the company or organization that owns the factory including all of its parent companies and/or organizations, and their respective country of corporate citizenship.

S. Pedestrian Signal Assemblies

Pedestrian signals assemblies shall conform to the provisions in Section 86-4.06, "Pedestrian Signal Faces", of the Standard Specifications and these Special Provisions.

Pedestrian Signal Mounting Assemblies and Pedestrian Signal Housings shall be made from the same manufacturer and the section assemblies shall be uniform in appearance and alignment.

Pedestrian signals shall be provided with a polycarbonate egg crate or Z-crate screen.

Pedestrian signals shall be equipped with light emitting diode countdown pedestrian module in accordance to the following:

1. It shall comply with ITE specification: Pedestrian Traffic Control Signal Indications (PTCSI) Part 2: LED Pedestrian Traffic Signal Modules, Adopted March 19, 2004.
2. All modules shall fit in existing signal housings without the use of special tools.
3. All modules shall be certified in the Intertek LED Traffic Signal Modules Certification Program and be labeled with the ETL Verified Label as follows:

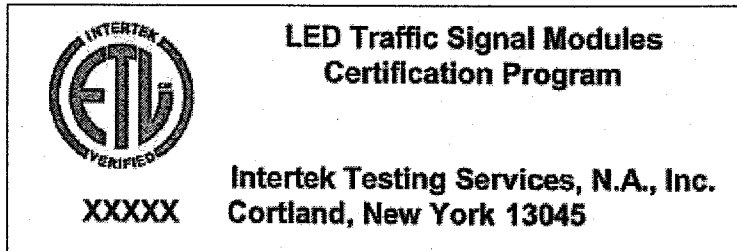

The PTCSI does not cover the countdown features of countdown pedestrian signal LED modules. The countdown features shall incorporate the following:

1. Fully compliant to NEMA TS-1, NEMA TS-2, Type 170, and Type 2070 traffic signal controller specifications.
2. The countdown portion of the pedestrian (ped) module shall have a high off-state input impedance so as not to provide a load indication to conflict monitors and interfere with the monitoring of the pedestrian signal. The input impedance of the countdown circuitry shall maintain a voltage reading above 25 VAC to the conflict monitor for up to four units connected on the same channel.
3. The countdown drive circuitry shall not be damaged when subjected to defective load switches providing a half wave signal input.
4. The countdown ped module shall have an internal conflict monitor circuit preventing any possible conflicts between the Hand, Person, and Countdown signal indications. It shall be impossible for the display to countdown during a solid Hand indication.
5. Per CA MUTCD Manual, section 4E.07: “ The countdown pedestrian signal shall display the number of seconds remaining until the termination of the pedestrian change interval. Countdown displays shall not be used during the walk interval or during the red clearance interval of a concurrent vehicular phase”.
6. The countdown ped module shall have a micro-processor capable of recording its own time when connected to a traffic controller. It shall be capable of displaying the digits 0 through 99.
7. When power is first applied or restored to the ped module, the countdown display will be blank during the initial cycle while it records the countdown time using the walk (person) and don't walk (flashing hand) signal indications. The normal hand and person icons shall be displayed during this cycle.

8. The countdown ped module shall continuously monitor the traffic controller for any changes to the pedestrian phase time and re-program itself automatically if needed.
9. The countdown ped module shall register the time for the walk and clearance intervals individually and shall begin counting down at the beginning of the pedestrian clearance interval. The digits shall not flash during the countdown.
10. When the flashing hand becomes solid, the ped module shall display 0 for one second and then blank-out. The display shall remain dark until the beginning of the next countdown.
11. In the event of a pre-emption, the countdown ped module shall skip the remaining time, reach 0 at the same time as the flashing Hand becomes solid, and remain dark until the next cycle.
12. In the cycle following preemption call, the signal shall display the correct time and not be affected by the reduced previous cycle. The countdown shall remain synchronized with the signal indications and always reach 0 at the same time as the flashing Hand becomes solid.
13. If a pedestrian button is activated during the clearance interval, some controllers can change to a second walk cycle without a don't walk phase. The countdown module shall also be capable of consecutive walk cycles. The display digits will be blank during the second walk and countdown properly during the second flashing hand.
14. The countdown ped module shall not display an erroneous or conflicting time when subjected to defective load switches. Should there be a short power interruption during the ped clearance interval or if voltage is applied to both the hand and person simultaneously the display will go to "0" then blank.
15. The countdown ped module shall have accessible dip-switches for the user selectable options. The unit shall have a removable plug on the rear allowing easy access to control the user selectable functions. The countdown is disabled when all the switches are in the "ON" position. The unit shall be shipped from the factory with the specified default setting.
16. Switch 1 – Blank Cycle Following a Timing Change – Factory default is "OFF". When this switch is "OFF" the unit will allow the time to be displayed normally during the cycle following a truncated timing such as a preemption call. The countdown shall be capable of displaying the correct time and not affected by the previous reduced cycle. The unit will require 2 consecutive reduced cycles of identical value to validate and record a new time setting. If the timing is extended, the unit will record it immediately. In the "ON" position when a change in timing is detected the unit will blank out during the following cycle while the new cycle time is measured and recorded if confirmed.
17. Switch 2 – Disables Auto-sync Mode- Factory default setting is "OFF". When this switch is in the "OFF" position the auto-sync is enabled. When the clearance interval begins and the initial flash of the hand is not in sync with the walk signal the unit will measure the offset and reduce the duration of the first second by the value of the offset. This will ensure the countdown reached zero at the same time as the flashing hand becomes solid. In the "ON" position there is no time correction when the flashing hand is in offset with the walk signal.

The duration of the first second will not be reduced and the hand will appear solid shortly before the countdown reaches zero.

18. Switch 3 – Countdown Starts with Flashing Hand Signal – Factory default setting is “ON”. When this switch is “ON” the countdown begins when the hand signal is turned on. With this switch “ON” and the auto-sync mode enabled a short power interruption will have no effect on the countdown display. With switch 3 in the “OFF” position the countdown begins when the walk signal is turned off. This eliminates the effect of an offset hand signal. When switch 3 is in the “OFF” position the auto-sync switch 2 has no effect on the countdown. In this mode if the power to the walk signal is interrupted, the unit will interpret this as the start of the clearance interval and will display the countdown time for 2 seconds before the operation is cancelled. The countdown will resume with the normal ending of the walk signal.
19. Switch 4 – Stores Time Value in Memory, Immediate. Restart. - Factory default setting is “OFF”. When this switch is in the “OFF” position and power is removed from the unit, the time value stored in the unit is erased. The unit will need to run a dark cycle before it can display the countdown again. In the “ON” position the countdown timing is stored in memory. Following a power interruption, the unit will restart with the stored value and not remain dark during the learning cycle. If the value is different after restart, it will be recorded and displayed correctly at the following cycle.
20. Switch 5 – All LEDs “ON”, Test Mode – Factory default setting is “OFF”. With this switch in the “ON” position all LEDs are turned on simultaneously. With both switches 4 and 5 in the “ON” position the LED test mode will also scan the 7 individual segments of both digits.
21. The countdown shall be disabled when all switches are placed in the “ON” position.
22. Nominal power usage for Ped Modules at 25°C (77°F), 120 VAC input shall not exceed the values shown in Table 1.

Table 1 -- Nominal Power of Pedestrian Signals

Size	Description	Wattage @ 25°C		
		Hand	Person	Countdown ¹
16"x18"	Side by Side Hand & Person	8	7	N/A
16"x18"	Hand & Person Overlay with Countdown	9	7	5

¹ Wattage for the countdown is measured when the digits 18 are displayed.

23. All wiring shall meet the requirements of Section 13.02 of the VTCSH standard. Secured, color coded, 600V, 18 AWG jacketed wires, 1 meter (39 in) in length, conforming to the NFPA 70, National Electrical Code, and rated for service at +105°C, shall be provided.
24. The following color scheme shall be used for the ped module’s AC power leads: Orange for the upraised hand, Blue for the walking person, and White for common. The countdown

- portion of the LED ped module shall be internally wired to the hand and walking person power.
25. The AC power leads shall exit the ped module via a rubber grommited strain relief, and shall be terminated with insulated female quick connect terminals with spade / tab adapters. The leads shall be separate at the point at which they leave the ped module.
 26. All external wiring utilized in the ped modules shall be anti-capillary type wire to prevent the wicking of moisture to the interior of the ped module.
 27. The Hand and Person Icons shall utilize separate power supplies. On countdown products, the countdown ped module must have its own power supply but may take the incoming AC power from the hand / person AC signal lines. All power supplies shall be located inside the ped module.
 28. All power supplies shall be conformally coated for additional protection.
 29. Off State Voltage Decay: When the hand or person icon is switched from the On state to the Off state the terminal voltage shall decay to a value less than 10 VAC RMS in less than 100 milliseconds when driven by a maximum allowed load switch leakage current of 10 milliamps peak (7.1 milliamps AC).
 30. For a minimum period of 60 months, measured at 80 to 135 VAC RMS and over the ambient temperatures of -40°C to $+74^{\circ}\text{C}$ (-40°F to $+165^{\circ}\text{F}$), the minimum maintained luminance values for the ped modules, when measured normal to the plane of the icon surface, shall not be less than:
 - Walking Person, White: $2,200\text{ cd/m}^2$
 - Upraised Hand, Portland Orange: $1,400\text{ cd/m}^2$
 - Countdown Digits, Portland Orange: $1,400\text{ cd/m}^2$
 31. The external lens shall have a textured outer surface to reduce glare.
 32. Icons that are printed on the lens shall be on the interior surfaces in order to prevent scratching and abrasion to the icons.
 33. All icons and numbers shall have a uniform incandescent non-pixelated appearance.
 34. All exposed components of a ped module shall be suitable for prolonged exposure to the environment, without appreciable degradation that would interfere with function or appearance. As a minimum, selected materials shall be rated for service for a period of a minimum of 60 months in a south-facing Arizona Desert installation.
 35. All LEDs used to illuminate the ped module shall use material that has industry acceptance for use in outdoor applications. At no time is the use of LEDs that utilize AlGaAs technology acceptable.

36. The countdown display shall consist of two 7 segment digits as shown below. All countdown display digits shall be 9 inches in height for use in all size crosswalks in compliance with MUTCD recommendations.

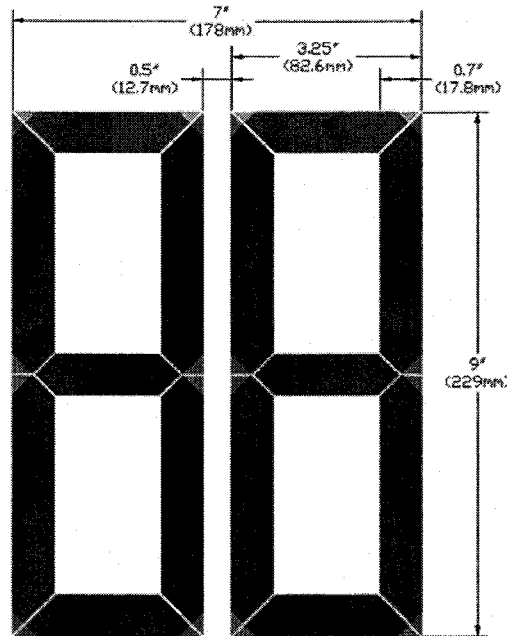

Figure 2: Countdown Display

37. Ped modules shall be repaired or replaced if the ped module fails to function as intended due to workmanship or material defects within warranty period.
38. Ped modules shall be repaired or replaced if the ped module exhibit luminous intensities less than the minimum specified values within 60 months of the date of delivery.
39. The manufacturer shall clearly disclose the country in which the factory of ped module origin is located, the name of the company or organization that owns the factory including all of its parent companies and organizations, and their respective country of corporate citizenship.

T. Pedestrian, Bicycle and Equestrian Push Buttons

Pedestrian, bicycle, and equestrian push buttons shall conform to the provisions in Section 86-5.02, "Pedestrian Push Button Assemblies", of the Standard Specifications and these Special Provisions.

Push button assembly shall be Type B per Standard Plans ES-5C.

Push button housing shall be die-cast or permanent mold cast aluminum powder coated frame with stainless steel inserts and sign screws.

Push button sign shall be white powder coat base with black heat cured ink. Right and left arrow signs shall be doubled sided.

Push button shall be Polara Engineering, Inc. model BDLM2-Y, or approved equal.

Push button shall utilize solid state Piezo switch technology, pressure activated, two-tone audible, visual LED confirmation of actuation and shall be ADA compliant.

The equestrian push buttons (EPB) shall be installed at 6 feet above finish grade or as directed by the Engineer. The Engineer shall approve the EPB placement on each pole prior to installation.

U. Detectors

Detectors shall conform to the provisions in Section 86-5, "Detectors", of the Standard Specifications and these Special Provisions.

Delay timers shall delay calls only during display of the associated red or yellow indications. If a vehicle departs the area of detection prior to expiration of the assigned delay period, the timer shall reset and no call shall be placed upon the controller. During display of the associated green indication, detectors shall operate in the present mode and calls shall not be delayed.

Inductive Loops

Detector loop configuration shall be Type E per Standard Plans ES-5B unless otherwise shown on the construction plan, in the Special Provisions, or as directed by the Engineer.

Limit Line detector loop configuration shall be modified Type E with diagonal saw cuts and wire winding conforming to Type D loop configuration.

Detector loop wire shall be Type 2.

Detector loop lead-in cable shall be Type B.

Detector loop curb terminations shall be Type A in accordance with Standard Plans ES-5D.

Loop sealant shall be the Hot-Melt Rubberized Asphalt sealant type, unless otherwise directed by the Engineer. Loop conductors and sealant shall be installed on the same day the loop slots are cut.

All detector loops shall be tested sequentially by the following methods:

- impedance (measured by megaohms)
- resistance (measured by ohms)
- inductance (measured in microhenries)

Video Detection

The contractor shall furnish and install video detection cameras (VDC), video detection processors (VDP), extension modules (EM), an industry standard 3-button USB mouse, a drawer mounted 17 inch LCD monitor, surge suppressors, and all necessary cabling and auxiliary equipment to make the video detection systems fully functional for the intended

operation. The Contractor shall furnish a spare VDC, a spare EM, and a spare VDP to the Engineer.

All equipment supplied shall come from and qualified by the VDP supplier to ensure proper system operation.

The VDC shall attach to the top of luminaire mast arm using mounting bracket provided by manufacturer, or the backside of signal mast arm using Pelco Astrobrac with 6' extension or approved equal. The Engineer shall approve the final camera placements.

The video detection systems shall be installed by supplier factory certified installers per recommended method provided in the supplier's installation manuals. Proof of factory certification shall be provided.

Video Detection Zones:

Placement of detection zones shall be done by using the supplied USB mouse connected to the VDP. Detection zones are drawn on the video image from the video camera displayed on a video monitor using the menu and graphical interface built into the VDP. The menu shall facilitate placement of detection zones and setting of zone parameters or to view system parameters.

Detection zone setup shall not require site-specific information such as latitude, longitude, date and time to be entered into the system. No separate computer shall be required to program the detection zones.

Each detection zone shall be user definable in size and shape to suit the site and the desired vehicle detection region. A detection zone shall be approximately the width and length of one car.

A single detection zone shall be able to replace multiple inductive loops and the detection zones shall be OR'ed as the default or may be AND'ed together to indicate vehicle presence on a single phase of traffic movement.

The VDP shall provide a minimum of 24 channels of vehicle presence detection/detection zones per camera through a standard detector rack edge connector and one or more EMs.

Functional Capabilities:

System must have a single point access to multiple rack-mounted video detection units. The access device shall provide interface capabilities to enable multiple rack-mounted video detection processors to be locally and remotely accessed from a single point via one set of user interface devices.

The camera shall be able to transmit the composite video signal, with minimal signal degradation, up to 1000 feet under ideal conditions.

The EM shall be plugged into the appropriate slot in the detector rack to avoid the need of rewiring the detector rack. The extension module shall be connected to the VDP by an 8-wire cable with modular connectors.

The EM and VDP communications shall be accommodated by methods using differential signals to reject electrically coupled noise. The EM shall be available in both 2 and 4 channel configurations programmable from the VDP.

The VDP shall have video input in NTSC composite video format and shall be digitized and analyzed in real time.

The VDP shall have a nine-pin RS232 port that is multi-drop compatible for communications with an external computer. The VDP shall be able to accept new detector patterns from and send its detection patterns to an external computer through this RS-232 port. A Windows™ based software designed for local or remote connection for uploading and downloading data, and providing video capture, real-time detection indication and detection zone modification capability shall be provided with the system.

The VDP shall store up to three different detection zone patterns within the VDP memory. The VDP's memory shall be non-volatile to prevent data loss during power outages. The VDP shall continue to operate (e.g. detect vehicles) using the existing zone configurations even when the operator is defining/modifying a zone pattern. The new zone configuration shall not go into effect until the operator saves the configuration. Each configuration can be uniquely labeled for identification and the current configuration letter is displayed on the monitor. The selection of the detection zone pattern for current use shall be done through a local menu selection or remote computer via RS-232 port. It shall be possible to activate a detection zone pattern for a camera from VDP memory and have that detection zone pattern displayed within 1 second of activation.

The VDP shall provide dynamic zone reconfiguration to enable normal detector operation of existing channels except the one where a zone is being added or modified during the setup process. The VDP shall output a constant call on any detection channel corresponding to a zone being modified.

The VDP shall detect vehicles in real time as they travel across each detector zone.

The VDP shall output a constant call for each enabled detector output channel if a loss of video signal occurs. The VDP shall output a constant call during the background learning period. The background learning period shall be not more than three minutes.

The VDP shall be capable of detecting a low-visibility condition automatically, such as fog, and place all defined detection zones in a constant call mode. The VDP shall automatically revert to normal detection mode when the low-visibility condition no longer exists. A user-selected output shall be active during the low-visibility condition that can be used to modify the controller operation if connected to the appropriate controller input modifier(s).

Detection shall be at least 98% accurate in good weather conditions and at least 96% accurate under adverse weather conditions (rain, snow, or fog). Detection accuracy is dependent upon

site geometry; camera placement, camera quality and detection zone location, and these accuracy levels do not include allowances for occlusion or poor video due to camera location or quality.

Detection zone outputs shall be configurable to allow the selection of presence, pulse, extend, and delay outputs. Timing parameters of pulse, extend, and delay outputs shall be user definable between 0.1 to 25.0 seconds.

Up to six detection zones shall be capable to count the number of vehicles detected. The count value shall be internally stored for later retrieval through the RS-232 port. The data collection interval shall be user definable in periods of 5, 15, 30 or 60 minutes.

System software shall

- Utilize a dual redundant hybrid tracking algorithm to enhance vehicle presence detection and data collection.
- Include a moving shadow and occlusion rejection algorithm that is activated by selection of a drop down menu tab.
- Include a menu selectable zone type labeled "Bike" that is specifically designed to detect bicycles.
- Include a virtual QWERTY keyboard that is present when performing any labeling functions for the detection zones and cameras.
- Include the ability to copy completed zones with one mouse click, drag and drop single zones, rows of zones together and entire detection configurations.

VDP & EM Hardware:

The VDP and EM shall be specifically designed to mount in a standard NEMA TS-1, TS-2, 2070 ATC, 170 type detector rack, using the edge connector to obtain power and provide contact closure outputs. No adapters shall be required to mount the VDP or EM in a standard detector rack. Detector rack rewiring shall not be required or shall be minimized.

Both VDP and EM shall operate in a temperature range from -34°C to +74°C and a humidity range from 0% RH to 95% RH, non-condensing.

Both VDP and EM shall be powered by 12 or 24 volts DC. These modules shall automatically compensate for the different input voltages.

Both VDP and EM shall include detector output pin out compatibility with industry standard detector racks.

Both VDP and EM shall have a detector test switch on the front panel to allow the user to place calls on each channel. The test switch shall be able to place either a constant call or a momentary call depending on the position of the switch.

The VDP power consumption shall not exceed 300 milliamps at 24 VDC. The EM power consumption shall not exceed 120 milliamps at 24 VDC.

The VDP shall utilize flash memory technology to enable the loading of modified or enhanced software through the RS232 port without modifying the VDP hardware.

The VDP shall include the following on the front panel:

- A multi-drop compatible RS232 port, a 9-pin "D" subminiature connector, for serial communications with a remote computer.
- Detection indication such as LED for each channel of detection that display detector outputs in real time when the system is operational.
- One or two BNC video input connection suitable for RS170 video inputs as required. The video input shall include a switch selectable 75-ohm or high impedance termination to allow camera video to be routed to other devices, as well as input to the VDP for vehicle detection. Video must be inputted via a BNC connector on the front face of the processor. RCA type connectors/jacks for video input are not allowed. Video shall not be routed via the edge connectors of the processor.
- One BNC video output providing real time video output that can be routed to other devices. A RCA type connector/jack for video output is not allowed.

Video Detection Camera:

The camera shall be housed in a weather-tight sealed enclosure consists of the following:

1. The enclosure shall be made of 6061 anodized aluminum.
2. The enclosure shall be field rotatable to allow proper alignment between the camera and the traveled road surface.
3. The enclosure shall be equipped with a sunshield. The sunshield shall include a provision for water diversion to prevent water from flowing in the camera's field of view. The camera enclosure with sunshield shall be less than 6" diameter, less than 18" long, and shall weigh less than 6 pounds when the camera and lens are mounted inside the enclosure.
4. The enclosure shall be design so that the pan, tilt and rotation of the camera assembly can be accomplished independently without affecting the other settings.
5. The enclosure shall include a proportionally controlled Indium Tin Oxide heater design that maximizes heat transfer to the lens. The output power of the heater shall vary with temperature, to assure proper operation of the lens functions at low temperatures and prevent moisture condensation on the optical faceplate of the enclosure.
6. The glass face on the front of the enclosure shall have:
 - a. An anti-reflective coating to minimize light and image reflections.
 - b. A special coating to minimize the buildup of environmental debris such as dirt and water.

The camera shall produce a useable video image of the bodies of vehicles under all roadway lighting conditions, regardless of time of day. The minimum range of scene luminance over which the camera shall produce a useable video image shall be the minimum range from nighttime to daytime, but not less than the range 1.0 lux to 10,000 lux.

The imager luminance signal to noise ratio shall be more than 50 dB. In harsh backlit conditions, vehicles can be detected flawlessly with >100dB of dynamic range.

The camera shall be digital signal processor based and shall use a CCD sensing element and shall output color video with resolution of not less than 540 TV lines. The CCD imager shall have a minimum effective area of 811(h) x 508(v) pixels.

The camera shall include an electronic shutter control based upon average scene luminance and shall be equipped with an auto-iris lens that operates in tandem with the electronic shutter.

The camera shall utilize automatic white balance.

The camera shall include a variable focal length lens with variable focus that can be adjusted, without opening up the camera housing, to suit the site geometry by means of a portable interface device designed for that purpose and manufactured by the detection system supplier.

The horizontal field of view shall be adjustable from 5.4 to 50.7 degrees. This camera configuration may be used for the majority of detection approaches in order to minimize the setup time and spares required by the user. The lens shall have a 27x zoom.

The lens shall also have an auto-focus feature with a manual override to facilitate ease of setup.

The camera shall incorporate the use of preset positioning that store zoom and focus positioning information. The camera shall have the capability to recall the previously stored preset upon application of power.

The camera electronics shall include automatic gain control to produce a satisfactory image at night.

When mounted outdoors in the enclosure, the camera shall operate satisfactorily in a temperature range from -34 °C to +60 °C and a humidity range from 0% RH to 100% RH. Measurement of satisfactory video shall be based upon VDP system operation.

The camera shall be powered by 120-240 VAC 50/60 Hz. Power consumption shall be 30 watts or less under all conditions.

The camera shall view approaching vehicles at a distance not to exceed 350 feet for reliable detection (height to distance ratio of 1:10). Camera placement and field of view shall be unobstructed and as noted in the installation documentation provided by the supplier.

There shall be at least 2 options for camera set up, diagnostic testing, and viewing video when it is mounted on mast arm or pole using lens adjustment module supplied by the VDP supplier:

1. Connected directly to the camera.
2. Connected to the coaxial cable from the cabinet.

The video signal shall be fully isolated from the camera enclosure and power
Cable terminations at the camera for video and power shall not require crimping tools.

No BNC or other connector shall be used for the coaxial video cable termination at the camera.

The power connection at the camera shall use connector terminations that only require the use of wire strippers and a standard screwdriver. No special crimping tools or other types of terminations shall be used.

A weather-proof protective cover shall be provided shall be provided to protect all terminations at the camera. No special tooling shall be required to remove or install the protective cap.

Cabling and Cable Connections:

The coaxial cable to be used between the camera and the VDP in the traffic cabinet shall be Belden 8281. The coax cable shall be a continuous unbroken run from the camera to the VDP. This cable shall be suitable for installation in conduit or overhead with appropriate span wire. A BNC plug connector shall be used at the cabinet end. The coaxial video cable shall be stripped and terminated at the camera and cabinet per manufacturers' instructions (no BNC or other connector shall be used at the camera). The coaxial cable, BNC connector used at the cabinet termination, and crimping tool shall be approved by the supplier of the video detection system and the manufacturer's instructions must be followed to ensure proper connection.

The power cable shall be three 16 AWG conductor cable with a minimum outside diameter of 0.325 inch and a maximum diameter of 0.490 inch. The power cable shall be terminated at the camera per manufacturers' instructions and shall only require standard wire strippers and a screw driver for installation (no special connectors or crimping tools shall be used for installation). The cabling shall comply with the National Electric Code, as well as local electrical codes. Cameras shall not acquire power from the luminaire.

A Din Rail mounted AC power panel assembly shall be supplied by the video detection manufacturer that will include a minimum of one convenience receptacle, four camera chassis ground connections, four camera AC neutral (AC-) connections, four 2 amp camera circuit breakers for hot (AC+) connections, and one AC source connection for Line, Neutral and Ground wires. A Din Rail video surge suppression protection panel assembly shall also be supplied by the video detection manufacture. One panel shall accommodate up to six EDCO surge suppressors.

Maintenance and Support:

The supplier shall maintain an adequate inventory of parts to support maintenance and repair of the system. These parts shall be available for delivery within 30 days of placement of an acceptable order at the supplier's then current pricing and terms of sale for said parts.

The supplier shall maintain an ongoing program of technical support for the access unit and video detection system. This technical support shall be available via telephone, or via personnel sent to the installation site upon placement of an acceptable order at the supplier's then current pricing and terms of sale for on-site technical support services.

Installation or training support shall be provided by factory-authorized representative.

All product documentation shall be written in the English language.

V. Luminaries

Luminaires shall conform to the provisions in Section 86-6, "Lighting", of the Standard Specifications and these Special Provisions.

Luminaires shall be of the cutoff type and shall be 200, 250 or 400 Watt High Pressure Sodium Vapor as shown on the plans. The fixtures shall be constructed with flat lenses, integral ballasts, and detachable power unit assemblies. The power unit assemblies shall contain the ballast, starter board, capacitors, and a heavy-duty terminal block.

Each luminaire shall be furnished without the photoelectric unit receptacle.

Each luminaire shall have a 5-amp inline fuse installed inside the standard's hand hole.

W. Blank

X. Internally Illuminated Street Name Sign

Internally illuminated street name signs (IISNS) shall conform to the provisions in Section 86-6.09, "Internally Illuminated Street Name Signs", of the Standard Specifications and these Special Provisions.

The sign fixture, panels, and mounting assemblies shall be designed and constructed to prevent deformation, warp or failure when subjected to a minimum of 100 mph wind loads, as set forth in the latest AASHTO publication, "Standard Specifications for Structural Supports of Highway Signs, Luminaires, and Traffic Signals", and amendments thereto. The IISNS manufacturer shall submit a certificate of compliance conforming to the provisions in Section 6-1.07, "Certificates of Compliance", with each lot of IISNSs delivered.

The IISNS shall be double-faced Edge-lit LED sign with white translucent diamond grade reflective border, arrows, and lettering using 12" uppercase and 9" lowercase Clearview Series 5-W fonts. The background shall be green match color no. 14109 of FED-STD-595.

The standard IISNS height shall be 2' and length shall be 6', 8' or 10' attached to the 10 feet IISNS mast arm with Pelco SE-5015 mast arm sign bracket, or approved equal, per County Standard No. 1200.

Y. Photoelectric Controls

Photoelectric controls shall conform to the provisions in Section 86-6.07, "Photoelectric Controls", of the Standard Specifications and these Special Provisions.

Photoelectric controls shall be a dual Type V for luminaires and internally illuminated street name signs conforming to the County Standards No. 1207.

Photoelectric units shall be the delay type.

Z. Emergency Vehicle Preemption System

Furnish and install complete and functioning emergency vehicle preemption (EVP) system as intended per plans, the manufacturer, and these special provisions.

The EVP system shall consist of the following equipments or components:

- Optical detector for each approach, as shown on the plans
- Rack-mounted 2-channel phase selectors for 8-phase operation
- Detector cable

The Contractor shall furnish the following spare EVP equipments or components:

- One (1) rack-mounted 2-channel phase selector
- One (1) optical detector

The EVP system shall be designed to prevent simultaneous pre-emption by two or more emergency vehicles on separate approaches to the intersection.

The Engineer shall approve EVP sequence of operation prior to timing and turn-on of each respective traffic signal.

At locations where optical detectors are not to be installed, EVP cable shall be installed for future use. The following also apply:

1. EVP cable shall be installed, without splices, between the controller cabinet and each mast arm traffic signal pole.
2. EVP cable shall be connected to the EVP rack terminals within the controller cabinet.
3. Each mast arm EVP detector mounting shall be drilled and tapped in its ultimate location. In lieu of the detector, install approved water tight UL listed electrical box. EVP cable shall be

installed to terminate within the mast arm mounted electrical box. Excess cable shall be coiled within the electrical box sufficient for future installation of the EVP system.

Optical Detector

The optical detector shall be mounted on the indicated signal mast arm per County Standard No. 1202.

Each optical detector shall be waterproof unit capable of receiving optical energy from a single direction. The reception angle for each optical detector unit shall be a minimum of eight (8) degrees in all directions about the aiming axis of the unit.

Internal circuitry shall be solid state and electrical power shall be provide by the associated discrimination module.

Each optical detector unit shall have a minimum of a ½ inch NPT opening used for mounting and for bringing the connecting cable into the terminal block located within the assembly. The housing shall be provided with weep holes to permit drainage of condensed moisture.

Each optical detector shall be installed, wired, and aimed as specified by the manufacturer.

Cable

Optical detector cable shall meet the requirements of IPCEA-S-61-402/NEMA WC 5, Section 7.4, 600 V Control cable, 75 degrees C, Type B, and the following:

1. The cable shall contain 3 conductors, each of which shall be AWG# 20 (7 x 28) stranded, tinned copper. Insulation of individual conductors shall be color-coded: 1-Yellow, 1-Orange, and 1-Blue.
2. The shield shall be either tinned copper braid or aluminized polyester film with a nominal 20% overlap. When film is used, an AWG# 20 (7 x 28) stranded, tinned, bare drain wire shall be placed between the insulated conductors and the shield and in contact with the conductive surface of the shield.
3. The jacket shall be marked as required by IPCEA/NEMA.

The cable run between each detector and the Traffic Controller cabinet shall be continuous without splices.

Phase Selector

Each phase selector shall conform to the requirements of Chapter I of the State of California, Department of Transportation, "Traffic Signal Control Equipment Specifications", shall be compatible and usable with a Model 170E or 2070 controller unit, and shall be mounted in the input file of a Model 332 or Model 333 JP controller cabinet.

Each phase selector shall be capable of operating at least two or more channels, each of which shall provide an independent output for each separate input.

Each phase selector, when used with its associated optical detectors, shall perform as a minimum, the following:

1. Receive Class I and Class II signals.
2. Decode the signals based on optical frequency, at 9.639 Hz + or -0.119 Hz for Class I signals and 14.035 Hz + or -0.255 Hz for Class II signals.
3. Establish the validity of received signals based on optical frequency and length of time received. A signal shall be considered valid only when received for more than 0.50 second. No combination of Class I signals shall be recognized as a Class II signal regardless of the number of signals being received, up to a maximum of 10 signals. Once a valid signal has been recognized, the effect shall be held by the module, in the event of temporary loss of signal for a minimum period of 4.0 seconds.
4. Provide an output for each channel that will result in a "low" or grounded condition of the appropriate input of a Model 170 controller unit. For a Class I signal, the output shall be a 6.25 Hz + or - 0.1 %, rectangular waveform with a 50 % duty cycle. For Class II signal, the output shall be steady.

Each phase selector shall receive power from the controller cabinet at either 12 VDC or 120 VAC.

Auxiliary inputs for each channel may enter each module through a front panel connector or by a parallel hook-up of the associated detector cables at the input location.

The phase selector shall provide an optically isolated output for each channel to the Model 170 controller unit. All output signals shall comply with NEMA signal level definitions and shall be compatible with the Model 170 controller assemblies' inputs.

Each phase selector shall be provided with means of preventing transients received by the detector from affecting the Model 170 controller assembly.

Each phase selector shall have a single connector board and shall occupy one slot of the input file. The front panel of each phase selector module shall have a handle to facilitate withdrawal and have the following controls and functions for each channel:

1. Range adjustments for both class I and Class II signals.
2. A 3-position, center off, momentary contact switch, one position (down) labeled for test operation of Class I signals, and one position (up) labeled for test operation of Class II signals.
3. A "signal" indication and a "call" indication each for Class I and for Class II signals. The "signal" indications denote that a signal, which is not valid, has been received; a "call"

indication denotes a steady, valid signal has been received. These 2 indications may be accomplished with a single indication lamp.

In addition, the front panel shall be provided with additional connectors or ports used to perform other functions as specified by the manufacturer.

Cabinet Wiring

Wiring for a Model 332 cabinet shall conform to the following:

1. Slots 12 and 13 of input file "J" shall be wired to accept either a 2 channel or a 4 channel module.
2. Field wiring for the primary detectors, except the 24 VDC power, shall terminate on either terminal block TB-9 in the controller cabinet or on the rear of input file "J", depending on cabinet configuration. Where TB-9 is used, position assignments shall be as follows:
 - a. TB-9 - 1 = Not Used
 - b. TB-9 - 2 = + 24 VDC Out (Orange)
 - c. TB-9 - 3 = + 24 VDC Out (Orange)
 - d. TB-9 - 4 = EVA Detector (Yellow)
 - e. TB-9 - 5 = EVC Detector (Yellow)
 - f. TB-9 - 6 = DC Common Out (Blue)
 - g. TB-9 - 7 = EVB Detector (Yellow)
 - h. TB-9 - 8 = EVD Detector (Yellow)
 - i. TB-9 - 9 = DC Common Out (Blue)

Assuming TB9 - 2 and TB9 - 3 are unused on the "J" File, move wires on J11-J & J11-K (Twisted Pair) to J12-E & J13-E, respectively.

Field wiring for auxiliary detectors may terminate on terminal board TB-0 (If unused) in the controller cabinet. Use manufactures recommended wiring for these connections.

System Operation

The contractor shall demonstrate that the components of each system are compatible and will perform satisfactorily as a system. Satisfactorily performance shall be determined using the following test procedure during the functional test period:

1. Each system to be used for testing shall consist of an optical detector, an optical detector cable and a phase selector module.
2. The phase selector shall be installed in the proper input file slot of the Model 332 or 333 controller cabinet assembly.
3. Two tests shall be conducted; one using a Class I signal emitter and a distance of 1000 feet between the emitter and the detector, the other using a Class II signal emitter and a

distance of 1800 feet between the emitter and the detector. Range adjustments on the phase selector shall be set to "Maximum" for each test.

4. During the tests of the Class I and Class II emitters, the proper response from the Model 170E and 2070 controller unit during the "ON" interval and there shall be no improper operation of the Model 170E or 2070 controller unit or the monitor during the "OFF" interval.

Arrange for a technician from the EVP manufacturer, to be present for the first day of the traffic signal and lighting function test to insure proper installation and functioning of the EVP equipment.

Arrange for a technician from the controller assembly manufacturer to perform any controller modifications required for the installation, or operation, of the EVP equipment.

AA. Blank

BB. Battery Backup System

This special provision establishes the minimum requirements for a battery backup system (BBS) that shall provide power to a traffic signal system in the event of a power failure or interruption.

The BBS shall be designed for outdoor applications, in accordance with the current edition of Chapter 1, Section 8 requirements of Transportation Electrical Equipment Specifications (TEES).

The BBS batteries shall be external to the traffic signal controller cabinet as specified under "External Battery Cabinet Option" herein unless specified otherwise.

BBS cabinet shall be listed on the current Caltrans pre-qualified product list. The BBS shall include, but not limited to the following:

- cabinet,
- utility line/generator switch,
- inverter/charger,
- power transfer relay,
- a separate manually operated non-electronic bypass switch,
- batteries,
- all necessary hardware, shelving, and interconnect wiring.

The following figure shows BBS components interconnecting with each other and the controller cabinet to ensure interchangeability between all BBS manufacturers.

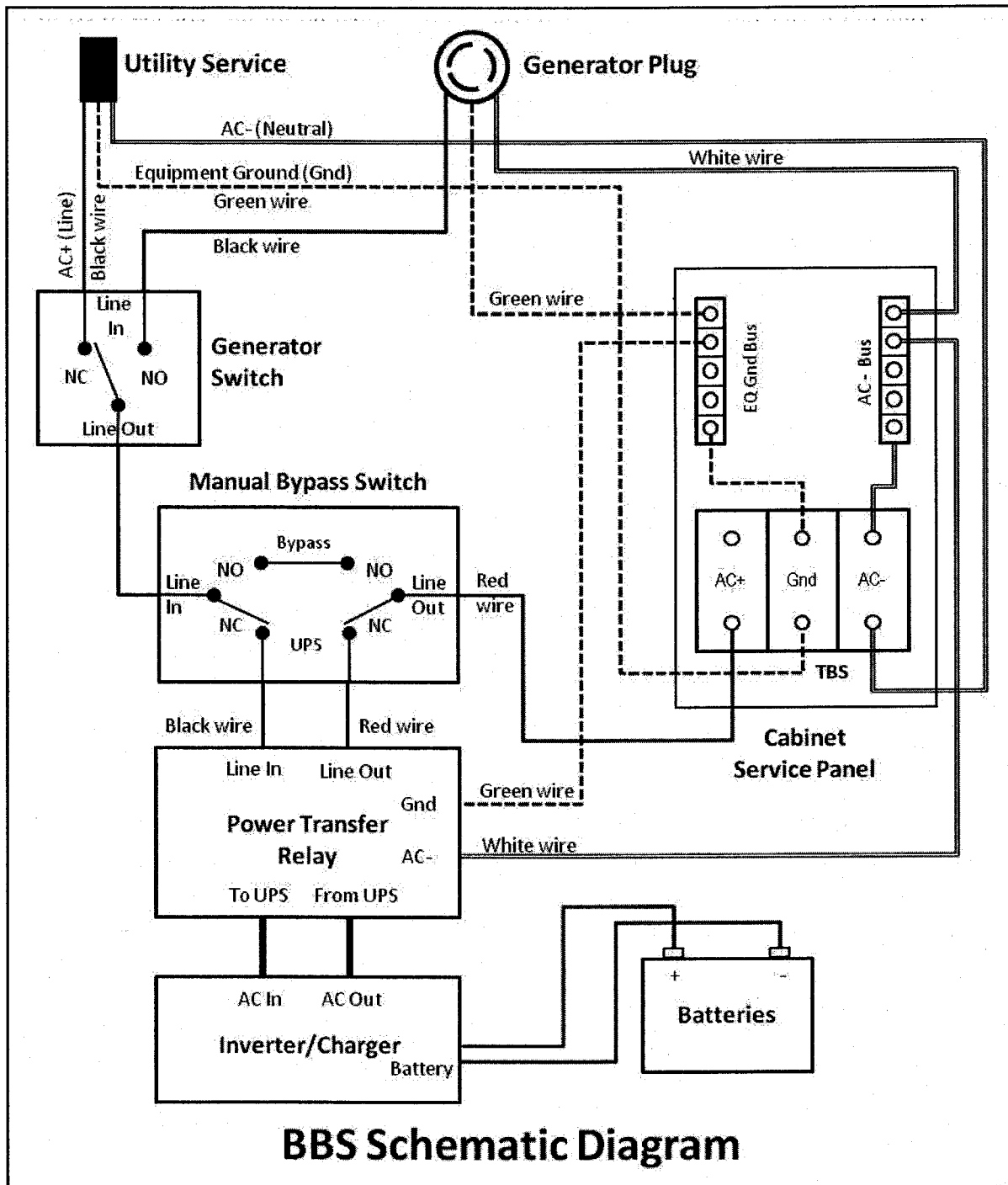

BBS Schematic Diagram

Operation

The BBS shall provide a minimum two (2) hours of full run-time operation for an intersection equipped with all LED traffic signal indications (minimum 1100W active output capacity, with 80% minimum inverter efficiency); and 2 (2) hours of flashing operation.

The maximum transfer time allowed, from disruption of normal utility line voltage to stabilized inverter line voltage from batteries, shall be 65 milliseconds. The same maximum allowable transfer time shall also apply when switching from inverter line voltage to utility line voltage.

The BBS shall provide the user with six (6)-sets of fully programmable normally open (NO) and normally closed (NC) single-pole double-throw (SPDT) dry relay contact closures, available on a panel-mounted terminal block, rated at a minimum 120V/1A, and labeled so as to identify each contact. See below figure for typical configuration.

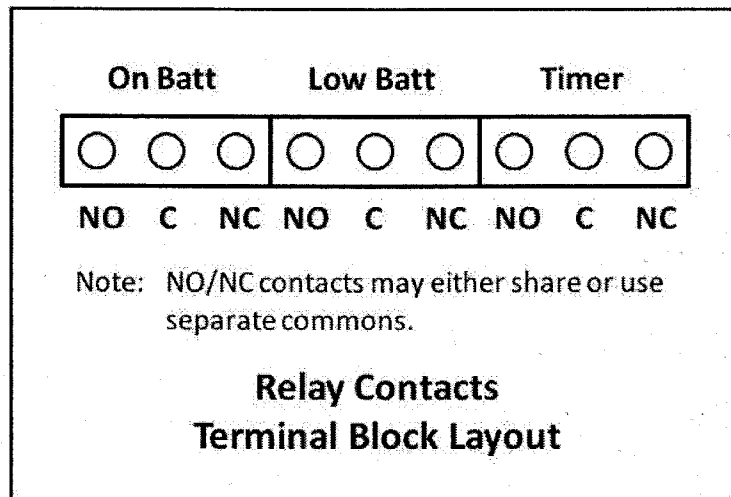

The first set of NO and NC contact closures shall be energized whenever the unit switches to battery power. Contact shall be labeled or marked "On Batt".

The second set of NO and NC contact closures shall be energized whenever the battery approaches approximately 40% of remaining useful capacity. Contact shall be labeled or marked "Low Batt".

The third set of NO and NC contact closures shall be energized two hours after the unit switches to battery power. Contact shall be labeled or marked "Timer".

The six programmable NO and NC contact closures shall be independently configured to activate under any of the following conditions: On Battery, Low Battery, Timer, Alarm, or Fault.

Operating temperature for inverter/charger, power transfer relay and manual bypass switch shall be -37°C to $+74^{\circ}\text{C}$.

Both the Power Transfer Relay and Manual Bypass Switch shall be rated at 240VAC/30 amps, minimum.

The BBS shall use a temperature-compensated battery charging system. The charging system shall compensate over a range of 2.5 – 4.0 mV/ $^{\circ}\text{C}$ per cell.

The temperature sensor shall be external to the inverter/charger unit. The temperature sensor shall come with 10' of wire.

Batteries shall not be recharged when battery temperature exceeds $50\text{ }^{\circ}\text{C} \pm 3\text{ }^{\circ}\text{C}$.

BBS shall bypass the utility line power whenever the utility line voltage is outside of the following voltage range: 100VAC to 130VAC ($\pm 2\text{VAC}$).

When utilizing battery power, the BBS output voltage shall be between 110 VAC and 125 VAC, pure sine wave output, $\leq 3\%$ THD, $60\text{Hz} \pm 3\text{Hz}$.

BBS shall be compatible with NEMA and Model 332 and 333JP Cabinets, and Model 170, 390 & 2070 Controllers and cabinet components for full time operation.

In cases of low (below 100VAC) or absent utility line power, when the utility line power has been restored at above $105\text{ VAC} \pm 2\text{ VAC}$ for more than 30 seconds, the BBS shall transfer from battery backed inverter mode back to utility line mode.

In cases of high utility line power (above 130VAC), when the utility line power has been restored at below $125\text{VAC} \pm 2\text{ VAC}$ for more than 30 seconds, the BBS shall transfer from battery backed inverter mode back to utility line mode.

The BBS shall have an automatic tap to step up or step down the output voltage by 10 percent. The resulting output voltages shall remain within the above prescribed voltage range: 100VAC to 130VAC. This capability will extend BBS range for operating on input AC and not reverting to battery power.

BBS shall be equipped to prevent a malfunction feedback to the cabinet or from feeding back to the utility service.

In the event of inverter/charger failure, battery failure or complete battery discharge, the power transfer relay shall revert to the NC (and de-energized) state, where utility line power is connected to the cabinet.

Recharge time for the battery, from "protective low-cutoff" to 80% or more of full battery charge capacity, shall not exceed twenty (20) hours.

Mounting / Configuration

Generator Switch, Inverter/Charger, Power Transfer Relay and manually operated Bypass Switch shall fit inside a typical fully equipped traffic signal controller cabinet.

Mounting method inside the 332 and 333JP cabinet shall be shelf-mount, rack-mount or combination of either. Available rack space for front-mounted inside the 332 and 333JP cabinet is 3U or approximately 6 inches.

All interconnect wiring provided between Generator Switch, Inverter/Charger, Power Transfer Relay, Bypass Switch and Cabinet Terminal Service Block shall be no less than 9 feet of UL Style 1015 CSA TEW with the following characteristics:

- AWG Rating: 10 AWG
- Stranding: 105 strands of 30 10 AWG tinned copper
- Rating: 600 V, 105 °C, PVC Insulation

Relay contact wiring provided for each set of NO/NC relay contact closure terminals shall be 9 feet of UL Style 1015 CSA TEW 18 AWG wire, same ratings as above, except 16 strands of 30 18 AWG tinned copper.

All necessary hardware for mounting (shelf angles, rack, etc) shall be included in the **contract price paid** for the BBS, and no additional compensation will be allowed therefor.

Internal mounted battery option

(Allowed only if requested on the plans)

The controller cabinet shall be equipped with a generator twist lock flanged inlet receptacle, manual transfer switch and bypass switch.

The twist lock flanged inlet receptacle shall be Hubbell 2615, NEMA L5-30P Twist Lock Flanged Male Inlet Rated for 30A/125VAC or approved equal. Receptacle shall be mounted flush to the cabinet in a weatherproof lift cover plate made of impact-resistant thermoplastic and gray in color.

The bypass switch shall transfer the load, including the UPS to the twist lock inlet receptacle. The manual transfer switch shall be wired to prevent any back feed to the utility service. Both the bypass switch and manual transfer switch shall be rack mounted independently in the controller cabinet meeting industry standards.

Batteries shall be mounted on swing-tray mounted below the controller shelf. A minimum of six (6) bolts/fasteners shall be used to secure swing-trays to the 332 Cabinet standard EIA 19" rack. All bolts/fasteners and washers shall meet the following requirements:

- Screw type: Pan Head Phillips machine screw
- Size and Thread pitch: 10-32
- Material: 18-8 stainless steel (Type 316 stainless steel is acceptable as an alternate)
- Washer: Use one 18-8 stainless steel flat washer under the head of each 10-32 screw; lock washers are unnecessary provided that the screws are properly tightened.

Number of screws per swivel bracket: minimum six (6) screws per swivel bracket. Screws are to be spaced evenly along bracket, with one screw near each end. Batteries may be shelf mounted in area behind controller so long as shelf and batteries do not interfere with controller unit and C1 plug.

External battery cabinet option

Batteries shall be housed in an external cabinet mounted to the side of the controller cabinet as shown in the following figure or as directed by the Engineer with a minimum of eight (8) bolts:

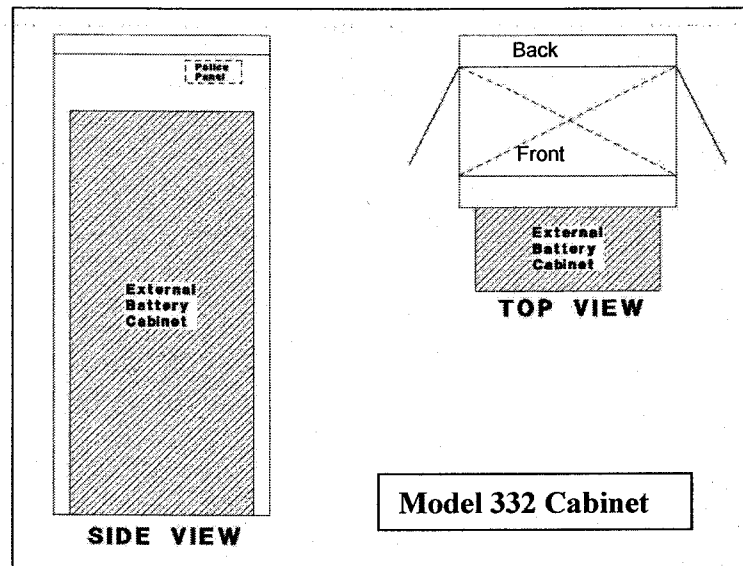

If BBS is installed at the back of controller cabinet, the modification shall include a minimum of 36 inches wide concrete walkway access to the BBS without encroaching outside the right-of-way. BBS shall be installed at the front of the controller cabinet (in locations where the back of the controller cabinet has limited ROW or conflicting structures and facilities and other obstructions), the BBS cabinet shall not cover the police panel. The BBS cabinet shall also not hinder the access ramp's compliance with ADA requirements.

Four shelves shall be provided within the battery cabinet. There shall be a minimum of 12 inches clearance between shelves. Each shelf shall be a minimum of 9" X 25", and capable of supporting a minimum of 125 lbs. Batteries shall be mounted on individual shelves.

The external battery cabinet shall be NEMA 3R rated in accordance to Section 2-Housings of the Chapter 7 of TEES, for the construction of the cabinet and anodic coating finish.

The external battery cabinet shall be ventilated through the use of louvered vents, filter, and one thermostatically controlled fan in accordance to Section 2-Housings of the Chapter 7 of TEES.

External battery cabinet fan shall be AC operated from the same line output of the Manual Bypass Switch that supplies power to the controller cabinet.

The external battery cabinet shall have a door opening to the entire cabinet. The door shall be attached to the cabinet through the use of a continuous stainless steel piano hinge or four, two-bolts per leaf, hinges in accordance to Section 2-Housings of the Chapter 7 of TEES. The door shall use a three-point, roller locking mechanism and standard #2 key lock to lock the door. The door shall have a stainless steel handle.

The external cabinet shall be equipped with a generator twist lock flanged inlet receptacle, manual transfer switch and bypass switch.

The twist lock flanged inlet receptacle shall be Hubbell 2615, NEMA L5-30P, Twist Lock Flanged Male Inlet Rated for 30A/125V or approved equal. Receptacle shall be mounted flush to

the cabinet in a weatherproof lift cover plate made of impact-resistant thermoplastic and gray in color.

The bypass switch shall transfer the load, including the UPS to the twist lock inlet receptacle. The manual transfer switch shall be wired to prevent any back feed to the utility service. Both the bypass switch and manual transfer switch shall be rack mounted independently in BBS cabinet meeting industry standards.

The BBS with external battery cabinet shall come with all bolts, conduits and bushings, gaskets, shelves, and hardware needed for mounting.

Maintenance, Displays, Controls and Diagnostics

The BBS shall include a 2 line by 40 character LCD display to indicate current battery charge status, input/output voltages, time and settings of various conditions. The same parameters shall be available via RS232 or USB interfaces on the face of the BBS.

The BBS shall have lightning surge protection compliant with IEEE/ANSI C.62.41.

The BBS shall be capable of accepting firmware upgrades of the non-volatile, read-only memory via serial port communications. The updates shall be accomplished by uploading the software to the BBS over the RS232 serial port located on the face of the BBS.

The BBS shall be equipped with an integral system to prevent battery from destructive discharge and overcharge.

The BBS shall be capable of performing a SELF-TEST, locally from the BBS front panel LCD, or remotely via RS232 or USB interface. The duration of the SELF-TEST shall be programmable in 1-minute increments from 1 minute to 255 minutes.

The BBS and batteries shall be easily replaced with all needed hardware and shall not require any special tools for installation.

The BBS shall include a re-settable inverter event counter to indicate the number of times the BBS was activated and the total number of hours the unit has operated on battery power, accessible via the LCD screen or remotely via RS232 or USB.

The BBS shall be equipped with an event log that stores for a minimum the last 100 events. The events shall be time and date stamped. The event log shall be retrievable vial RS232, USB or from the BBS LCD screen. The event log shall be display and print out in plain English when output the RS232 or USB ports.

Battery System

Individual battery shall be 12V, rated 105 amp-hour for 20 hours @ 77°F to 1.70 VPC, deep cycle, sealed prismatic lead-calcium based Absorbed Glass Mat/ Valve Regulated Lead Acid (AGM/VRLA) battery and shall be easily replaced and commercially available off the shelf.

The manufacturer shall certify batteries to operate over a temperature range of -25°C to $+74^{\circ}\text{C}$. The batteries shall be provided with appropriate interconnect wiring and corrosion-resistant mounting trays and/or brackets appropriate for the cabinet into which they will be installed.

Batteries shall indicate maximum recharge data and recharging cycles.

Furnish four (4) batteries for the BBS.

Battery Harness

Battery interconnect wiring shall be via two-part modular harness:

- Part I shall be equipped with red (+) and black (-) cabling that can be permanently connected to the positive and negative posts of each battery. Each red and black pair shall be terminated into a Molex, polarized – keyed battery cable connector or equivalent. The length of the harness between batteries shall be a minimum of 12 inches.
- Part II shall be equipped with the mating Power Pole style connector for the batteries and a single, insulated Power Pole style connection to the inverter/charger unit. Harness shall be fully insulated and constructed to allow batteries to be quickly and easily connected in any order to ensure proper polarity and circuit configuration. The length of the battery interconnect harness shall be a minimum of 60 inches from the Inverter/Charger plug to the first battery in the string.

Power Pole connectors may be either one-piece or two-piece. If a two-piece connector is used, a locking pin shall be used to prevent the connectors from separating.

All battery interconnect harness wiring shall be UL Style 1015 CSA TEW or Welding Style Cable or equivalent, all of proper gauge with respect to design current and with sufficient strand count for flexibility and ease of handling.

Battery terminals shall be covered and insulated with molded boots to prevent accidental shorting.

BBS Quality Assurance

Each Battery Backup System (BBS) shall be manufactured in accordance with a manufacturer Quality Assurance (QA) program. The QA program shall include two Quality Assurance procedures:

1. Design QA - The manufacturer, or an independent testing lab hired by the manufacturer, shall perform Design Qualification Testing on new BBS system(s) offered, and when any major design change has been implemented on an existing design. A major design change is defined as any modification - material, electrical, physical, or theoretical, that changes any performance characteristics of the system, or results in a different circuit configuration. Where a dispute arises in determining if a system is a new design or if the system has had a major design change, the County will make the final determination if Design Qualification Testing is required prior to production consideration.

2. Production QA - The Production QA shall include statistically controlled routine tests to ensure minimum performance levels of BBS units built to meet this specification and a documented process of how problems are to be resolved.

QA process and test results documentation shall be kept on file for a minimum period of seven years.

Battery Backup System designs not satisfying Design QA Testing and Production QA Testing requirements shall not be labeled, advertised, or sold as conforming to this specification.

A technician whom is qualified to work on the battery backup system and employed by the battery backup system manufacturer or the manufacturer authorized distributor, shall be present at the time the equipment is turned on.

It shall be the responsibility of the Contractor to implement and fund any traffic signal controller assembly modifications required to achieve the traffic signal operation as shown on the construction plans and as required in the Special Provisions.

CC. Blank

DD. Payment Method

See Signal and Lighting subsection O, "Service" for payment of all electric company fees required.

The contract price paid **per Lump Sum** for Signal and Lighting shall include full compensation for furnishing all labor, materials, tools, equipment, additional load switch auxiliary bay, foundations, pole and mast arm mounted regulatory signs, documents, programming, testing, potholing required for utility verification prior to conduit installation and incidents and for doing all the work specified herein, elsewhere in these Special Provisions, and plans including the complete installation of an operational traffic signal and lighting system and no additional compensation shall be allowed therefor.

REFERENCE DRAWINGS

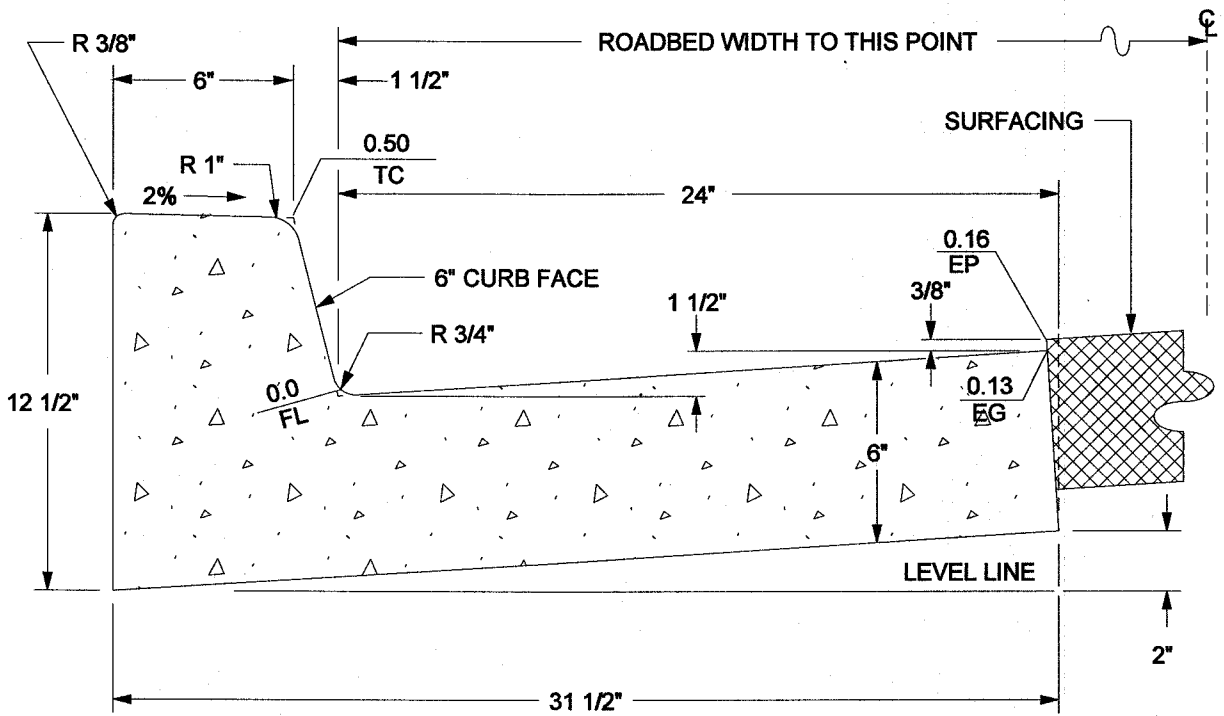

CLASS "B" CONCRETE

1.601 CU. FT. / L.F.

1 CU. YD. = 16.86 L.F.

ABBREVIATIONS:

TC = TOP OF CURB

FL = FLOWLINE

EG = EDGE OF GUTTER

EP = EDGE OF PAVEMENT

APPROVED BY:

George A. Johnson
 DIRECTOR OF TRANSPORTATION
 GEORGE A. JOHNSON, RCE 42328

DATE: 05/01/07



COUNTY OF RIVERSIDE

TYPE A-6 CURB

REVISIONS	REV.	BY:	APR'D	DATE	REV.	BY:	APR'D	DATE
8-71, 9-88	1				4			
2-90, 11-04	2				5			
	3				6			

STANDARD NO. 200

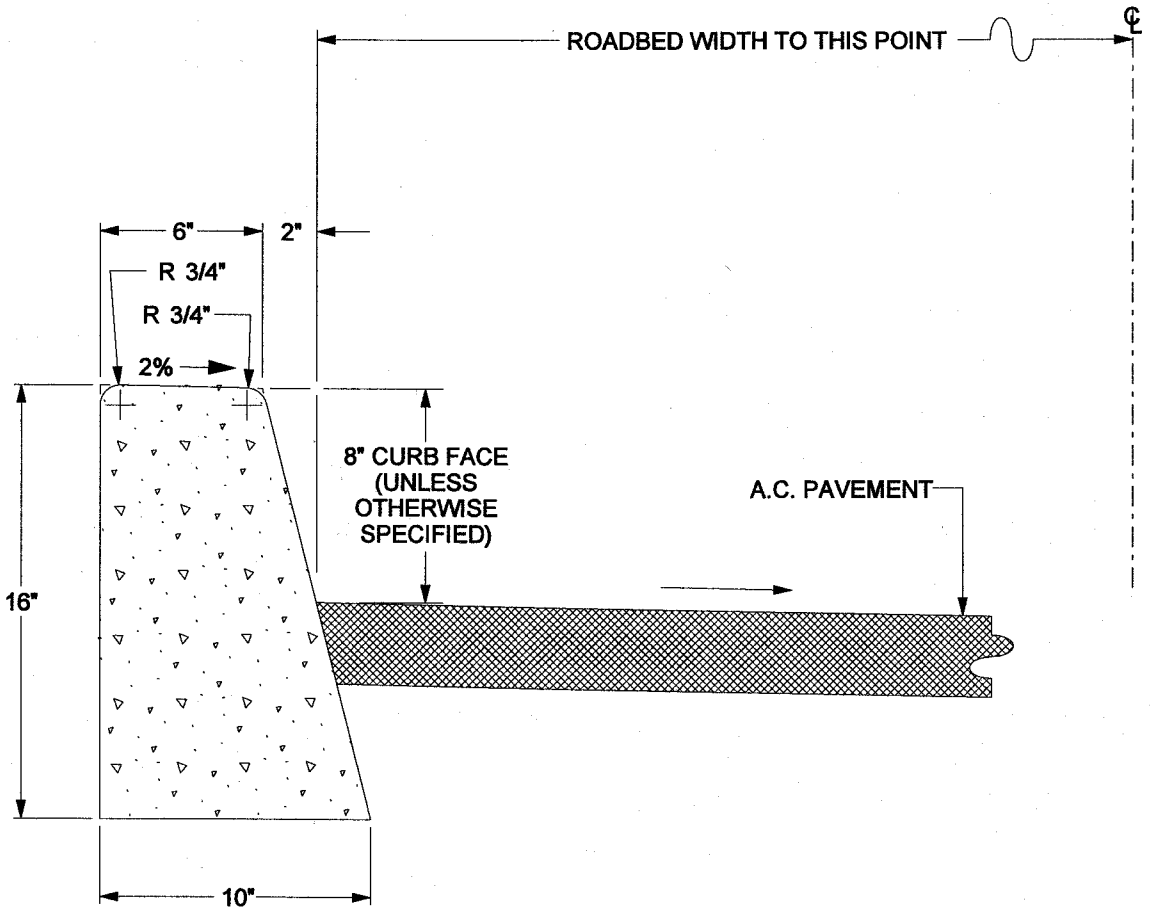

CLASS "B" CONCRETE

0.888 CU FT. / L.F.

1 CU. YD. = 30.41 L.F.

APPROVED BY:

George A. Johnson

DATE: 05/01/07

DIRECTOR OF TRANSPORTATION
GEORGE A. JOHNSON, RCE 42328

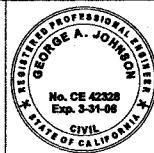

COUNTY OF RIVERSIDE

TYPE "D" CURB

STANDARD NO. 204

REVISIONS		REV.	BY:	APR'D	DATE	REV.	BY:	APR'D	DATE
8-71, 2-90		1				4			
11-04		2				5			
		3				6			

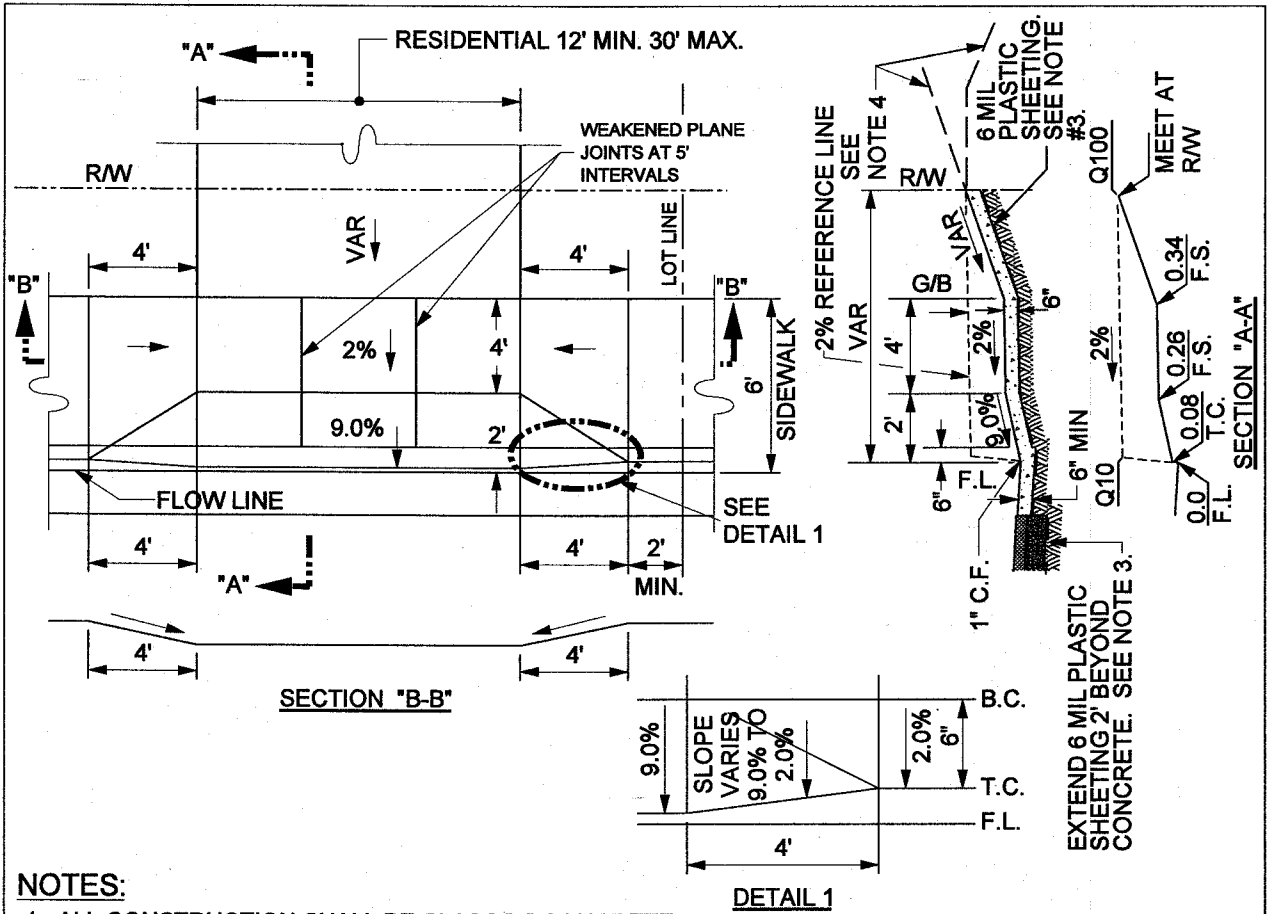

NOTES:

1. ALL CONSTRUCTION SHALL BE CLASS "3" CONCRETE.
2. 20' OF FULL-HEIGHT CURB REQUIRED BETWEEN DRIVEWAYS WITHIN ANY ONE PROPERTY FRONTAGE.
3. USE 6 MIL PLASTIC SHEETING WHEN ABUTTING SOIL HAS A HIGH SULFATE CONTENT, SPECIAL CONSIDERATIONS ARE REQUIRED. SEE SPECIFICATIONS (SECTION 16.04).
4. CONSTRUCT THE PROFILE GRADE OF THE PRIVATE ON-SITE DRIVEWAY SO THAT IT PROVIDES SMOOTH VEHICLE ACCESS OVER THE DRIVE APPROACH.

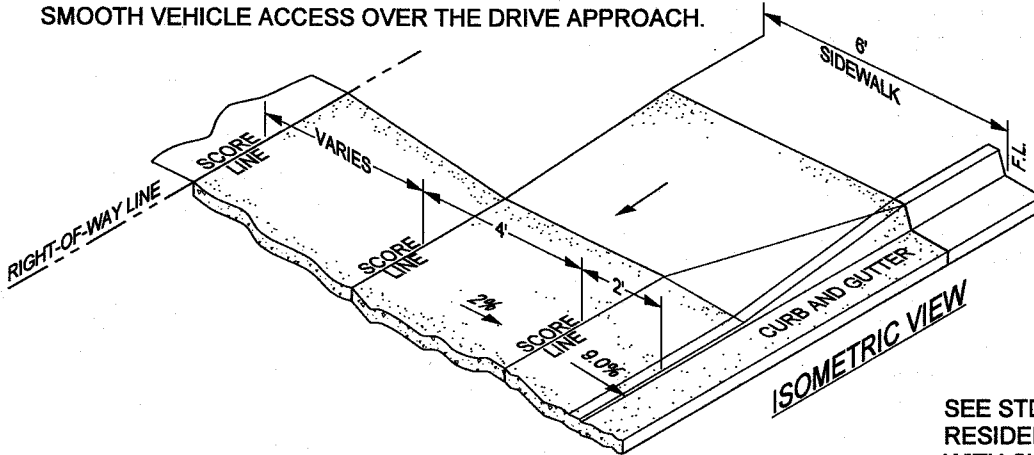

NOT TO SCALE

SEE STD NO. 213 FOR RESIDENTIAL DRIVEWAY WITH SIDEWALK AT RW

APPROVED BY:

George A. Johnson
 DIRECTOR OF TRANSPORTATION
 GEORGE A. JOHNSON, RCE 42328

DATE: 11/15/04

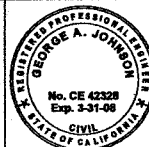

COUNTY OF RIVERSIDE

RESIDENTIAL DRIVEWAY WITH SIDEWALK AT CURB

REVISIONS		REV.	BY:	APR'D	DATE	REV.	BY:	APR'D	DATE
8-71, 8-77	11-04	1				4			
5-80, 2-82		2				5			
2-90, 12-97		3				6			

STANDARD NO. 207

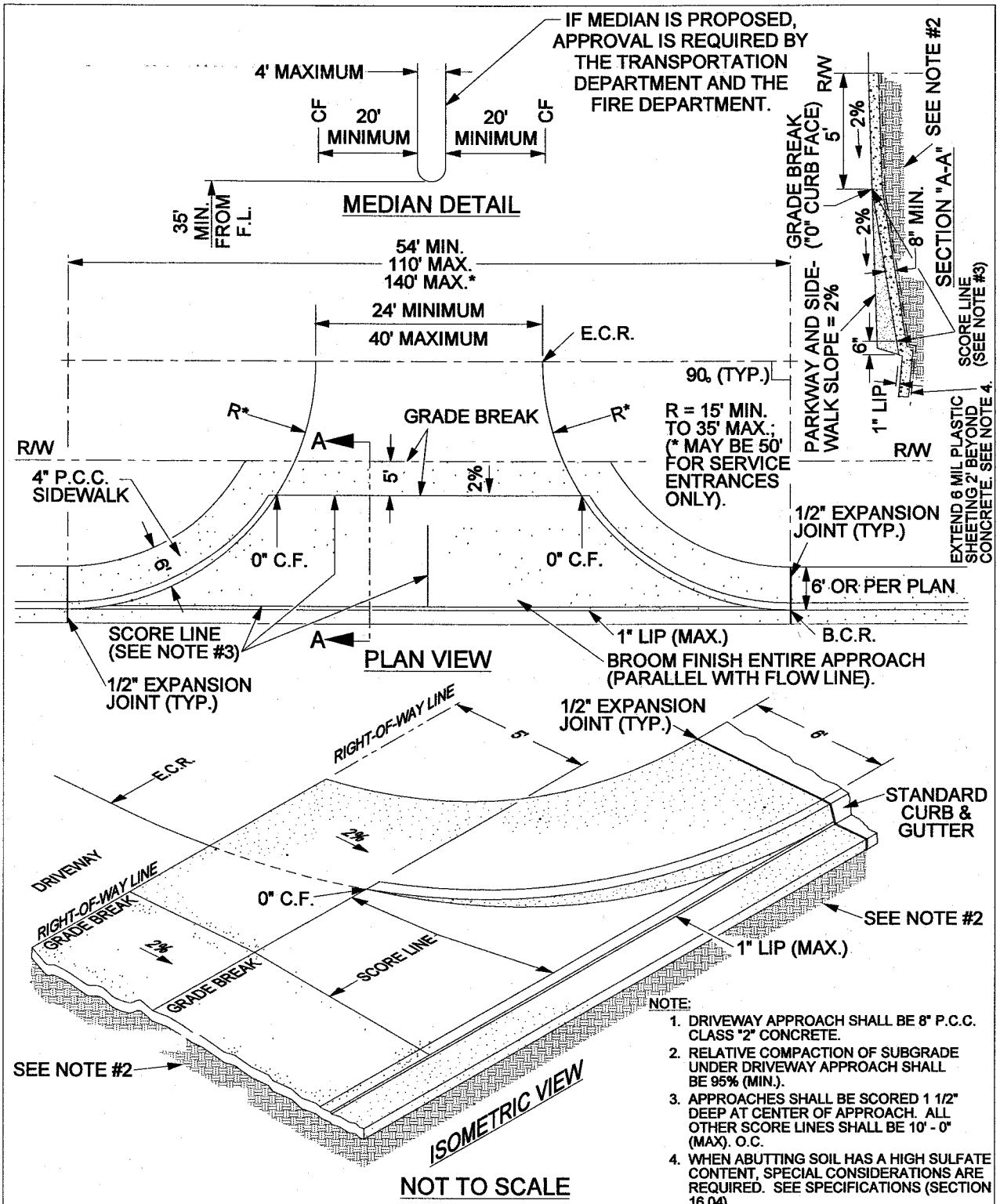

APPROVED BY:				COUNTY OF RIVERSIDE			
<i>George A. Johnson</i>				DATE: 11/15/04			
DIRECTOR OF TRANSPORTATION							
GEORGE A. JOHNSON, RCE 42328							
REVISIONS		REV.	BY:	APR'D	DATE	REV.	BY:
11-04		1				4	
		2				5	
		3				6	
				COMMERCIAL DRIVEWAY (WITH SIDEWALK AT CURB)			
				STANDARD NO. 207A (1 OF 2)			

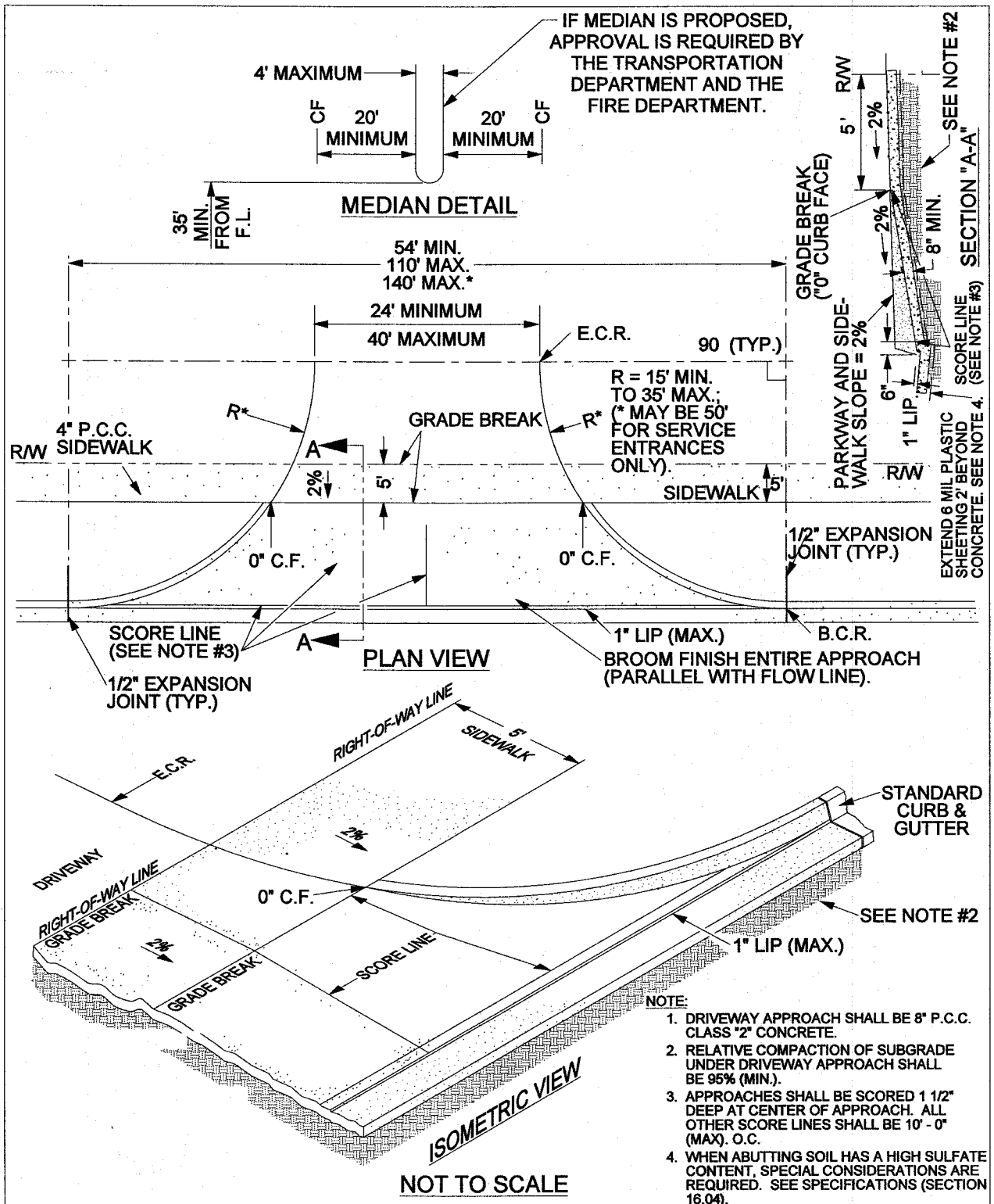

APPROVED BY:

George A. Johnson
 DIRECTOR OF TRANSPORTATION
 GEORGE A. JOHNSON, RCE 42328

DATE: 11/15/04

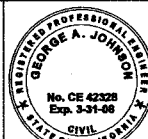

COUNTY OF RIVERSIDE

**COMMERCIAL DRIVEWAY
 (WITH SIDEWALK AT R/W)**

REVISIONS	REV.	BY:	APR'D	DATE	REV.	BY:	APR'D	DATE
11-04	1				4			
	2				5			
	3				6			

STANDARD NO. 207A (2 OF 2)

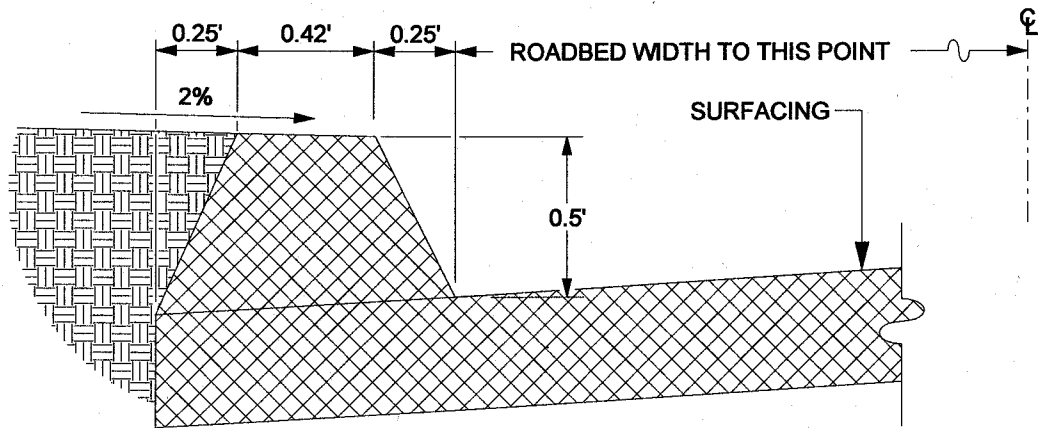

6" A.C. DIKE

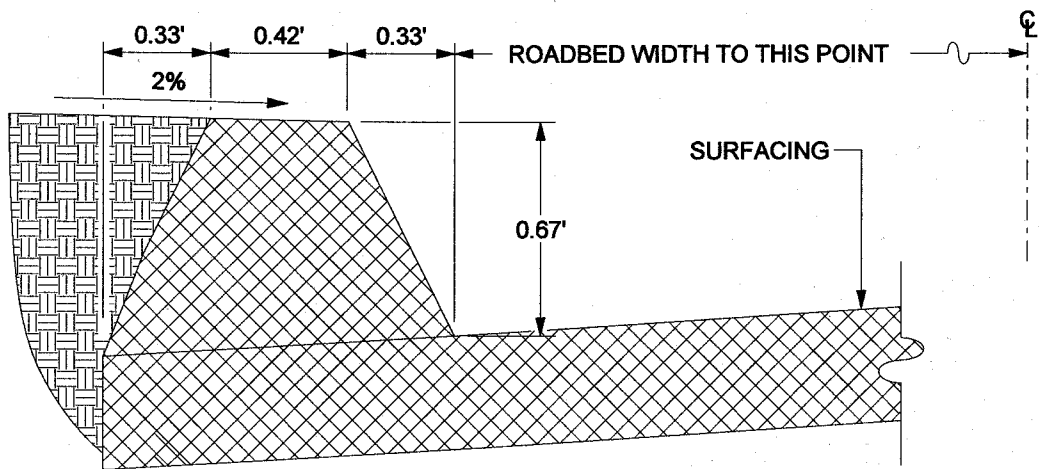

8" A.C. DIKE

NOT TO SCALE

NOTE: A.C. DIKE REQUIRED WHERE FILL SLOPES ARE STEEPER THAN 4:1, MATERIAL IS SUSCEPTIBLE TO EROSION, OR WHERE ROADWAY GRADIENT EXCEEDS 3%.

APPROVED BY:

George A. Johnson
 DIRECTOR OF TRANSPORTATION
 GEORGE A. JOHNSON, RCE 42328

DATE: 05/01/07

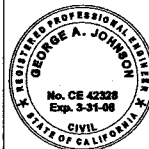

COUNTY OF RIVERSIDE

**ASPHALT CONCRETE
 DIKES**

REVISIONS				REV.	BY:	APR'D	DATE	REV.	BY:	APR'D	DATE
				1				4			
				2				5			
				3				6			

STANDARD NO. 212

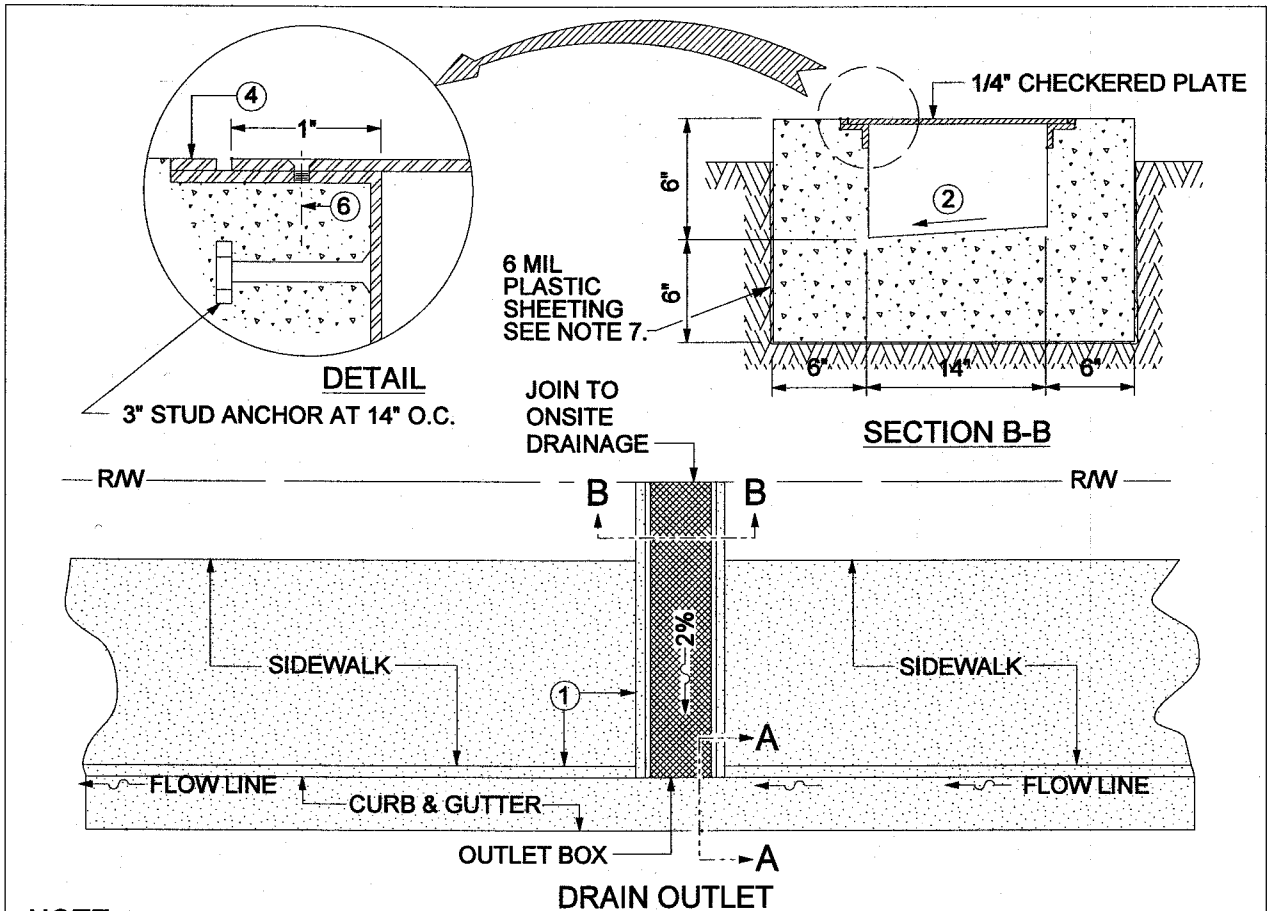

NOTE

- ① UNDER SIDEWALK DRAIN TO BE CONSTRUCTED AT 90°. VARIATIONS FROM 90° REQUIRE THE APPROVAL OF THE DIRECTOR OF TRANSPORTATION.
- ② SLOPE TO DRAIN TO ONE SIDE.
- ③ ALL EXPOSED METAL PARTS TO BE GALVANIZED AFTER FABRICATION.
- ④ 1 1/2" X 1 1/2" X 1/4" "L" FRAME WITH 3/8" X 1/4" STEEL STRIP WELDED TO FRAME.
- ⑤ CHECKERED PLATE SHALL BE GALVANIZED STEEL, MAXIMUM WIDTH 36".
- ⑥ FASTEN WITH 1/4" COARSE-THREAD COUNTERSINK METAL SCREWS AT 12" O.C..
- ⑦ WHEN ABUTTING SOIL HAS A HIGH SULFATE CONTENT, SPECIAL CONSIDERATIONS ARE REQUIRED. SEE SPECIFICATIONS (SECTION 16.04).

NOT TO SCALE

APPROVED BY:

George A. Johnson
 DIRECTOR OF TRANSPORTATION
 GEORGE A. JOHNSON, RCE 42328

DATE: 05/01/07

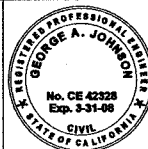

COUNTY OF RIVERSIDE

**UNDER SIDEWALK
 DRAIN
 CAST IN PLACE**

STANDARD NO. 309

REVISIONS		REV.	BY:	APR'D	DATE	REV.	BY:	APR'D	DATE
11-04		1				4			
		2				5			
		3				6			

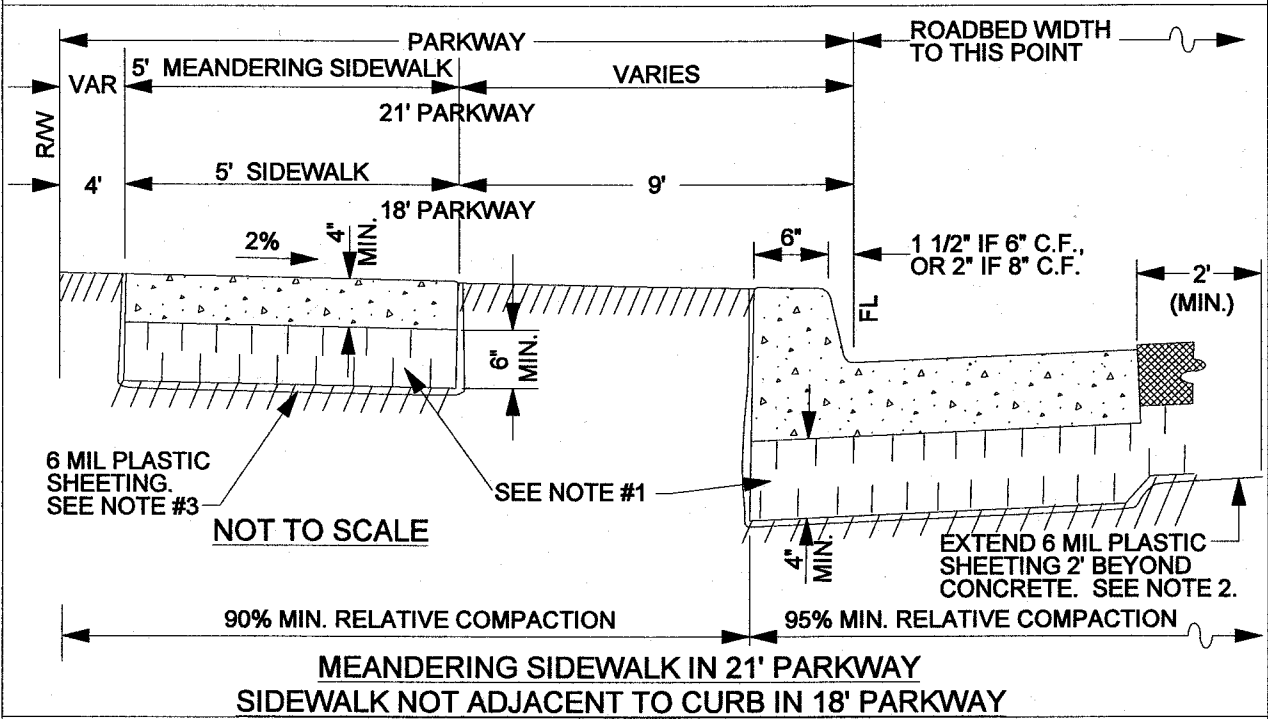
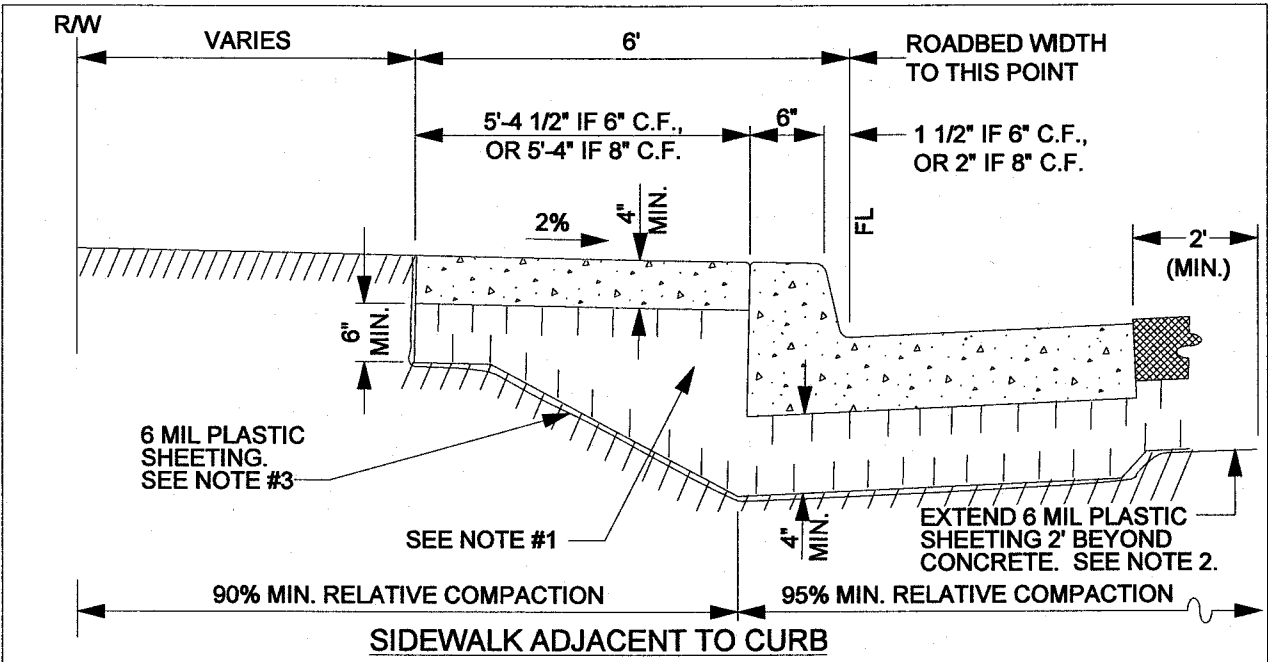

NOTE:

1. AGGREGATE BASE OR APPROVED SELECT MATERIAL WHEN SOILS REPORT INDICATES PRESENCE OF EXPANSIVE SOIL CONDITIONS.
2. ALL CONSTRUCTION SHALL BE CLASS "B" CONCRETE.
3. WHEN ABUTTING SOIL HAS A HIGH SULFATE CONTENT, SPECIAL CONSIDERATIONS ARE REQUIRED. SEE SPECIFICATIONS (SECTION 16.04).

APPROVED BY:

 DATE: 05/01/07
 DIRECTOR OF TRANSPORTATION
 GEORGE A. JOHNSON, RCE 42328



COUNTY OF RIVERSIDE

SIDEWALK AND CURB

REVISONS	REV.	BY:	APR'D	DATE	REV.	BY:	APR'D	DATE
8-71, 11-77	1				4			
8-82, 9-88	2				5			
4-90, 11-04	3				6			

STANDARD NO. 401

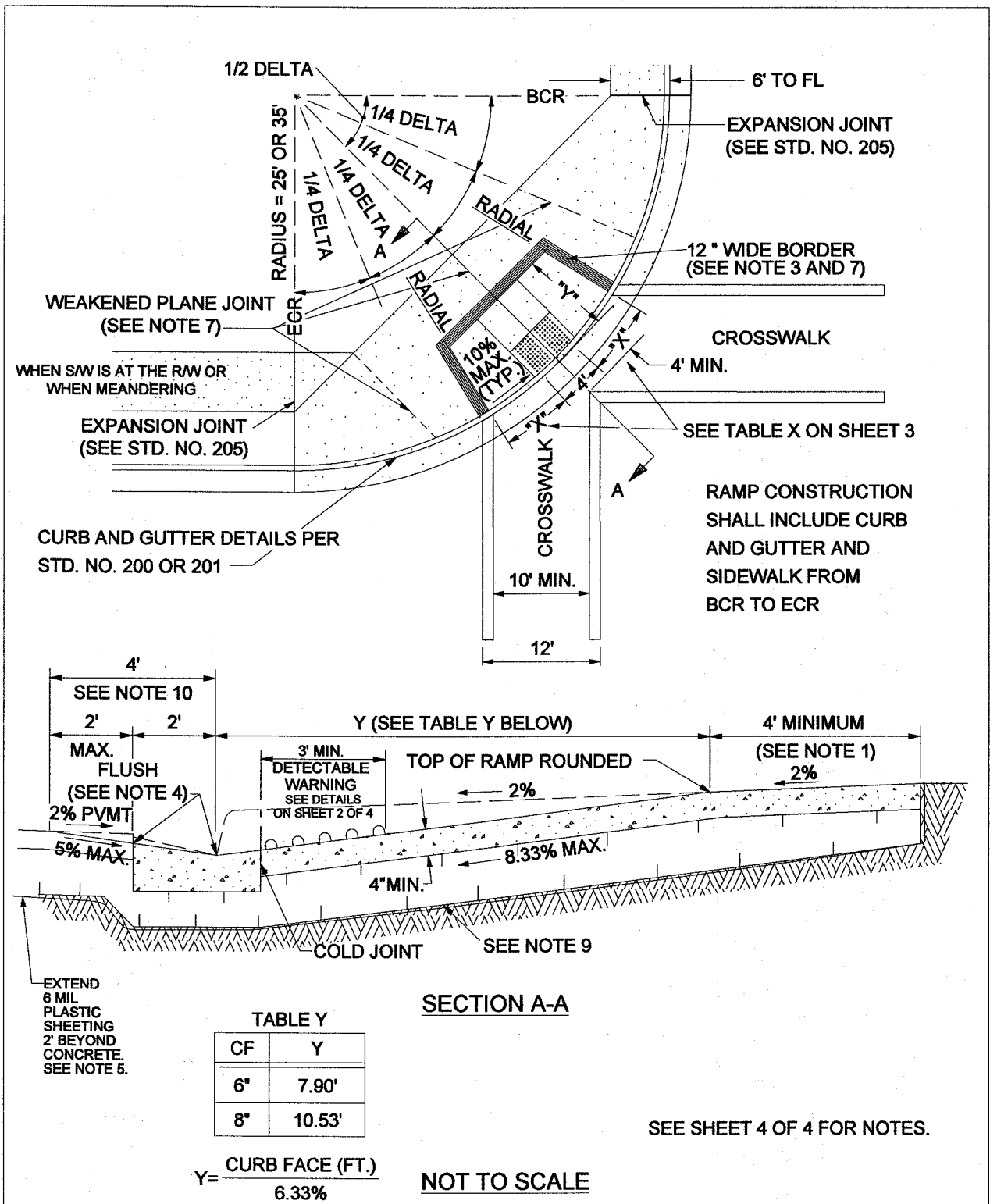

SEE SHEET 4 OF 4 FOR NOTES.

APPROVED BY:

George A. Johnson
 DIRECTOR OF TRANSPORTATION
 GEORGE A. JOHNSON, RCE 42328

DATE: 11/15/04

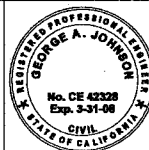

COUNTY OF RIVERSIDE

**CURB RAMP
 CASE A**

REVISIONS		REV.	BY:	APR'D	DATE	REV.	BY:	APR'D	DATE
8-77, 5-80	11-04	1				4			
10-81, 6-82		2				5			
9-88, 2-90		3				6			

STANDARD NO. 403 (1 OF 4)

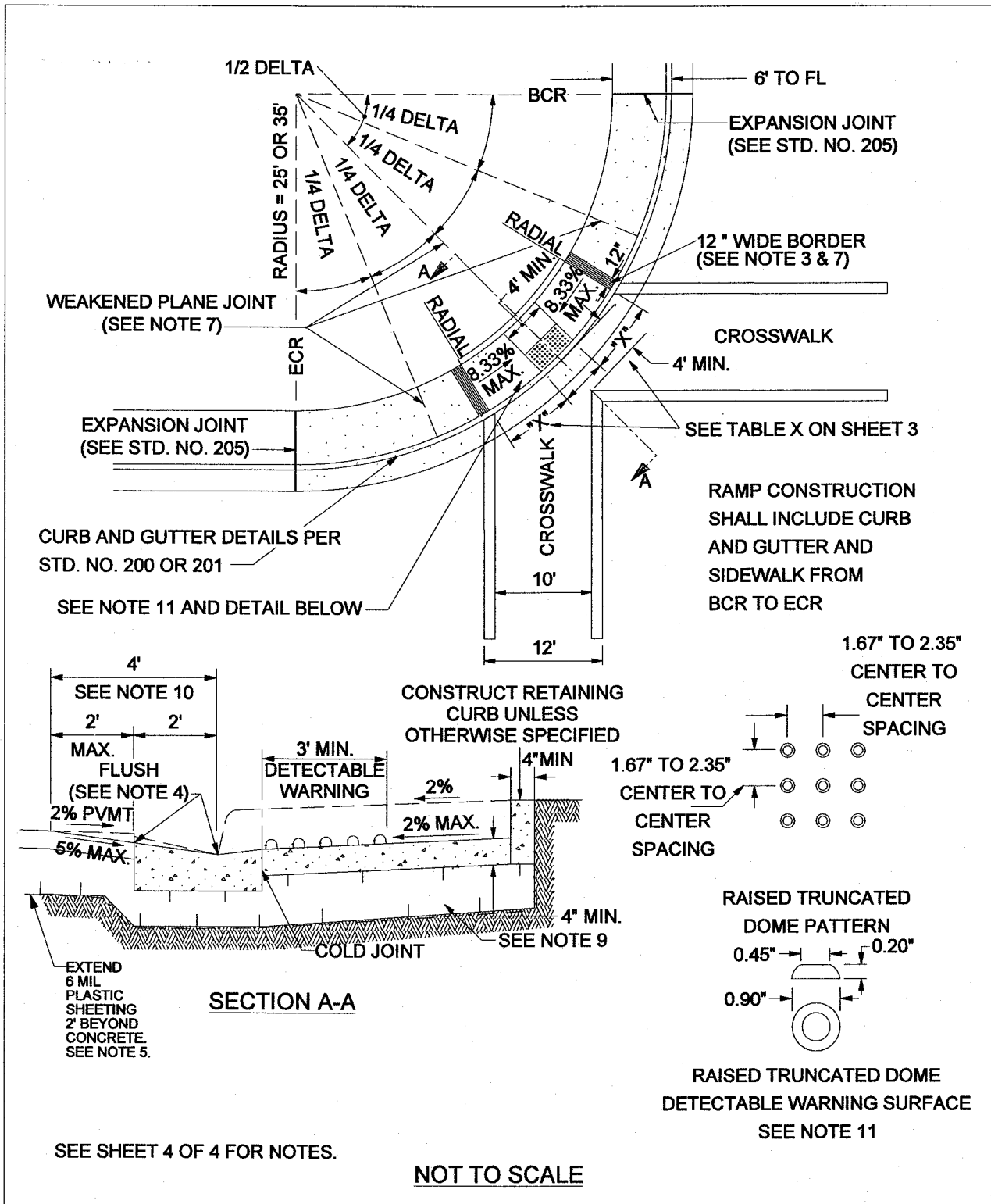

APPROVED BY:

George A. Johnson
 DIRECTOR OF TRANSPORTATION
 GEORGE A. JOHNSON, RCE 42328

DATE: 11/15/04



COUNTY OF RIVERSIDE

**CURB RAMP
 CASE B**

REVISIONS		REV.	BY:	APR'D	DATE	REV.	BY:	APR'D	DATE
8-77, 5-80	11-04	1				4			
10-81, 6-82		2				5			
9-88, 2-90		3				6			

12-97

STANDARD NO. 403 (2 OF 4)

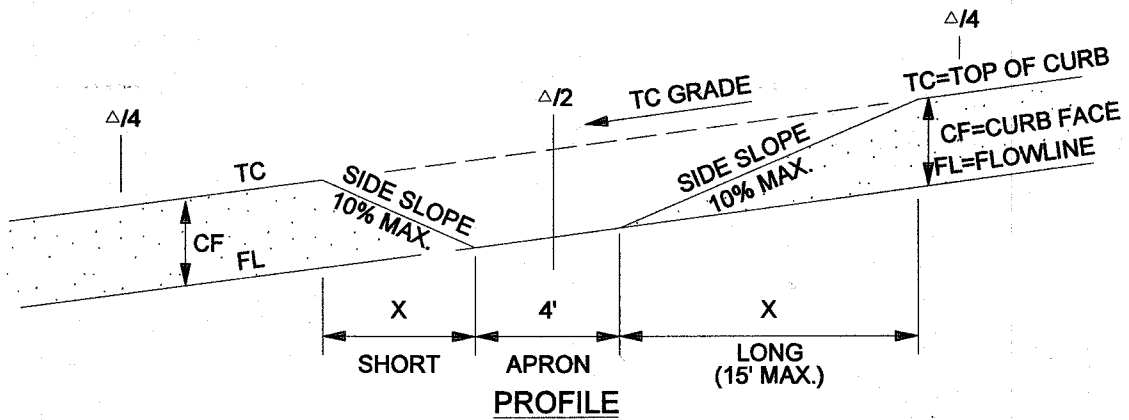

TABLE X

CF (IN)	RADIUS (FT)	SIDE SLOPE	X	TC GRADE (ALONG CURB RETURN)					
				1%	2%	3%	4%	5%	6%
6"	35'	10%	X _S	4.6	4.2	3.9	3.6	3.4	3.2
			X _L	5.6	6.3	7.2	8.4	10.0	12.5
8"	35'	10%	X _S	6.1	5.6	5.2	4.8	4.5	4.2
			X _L	7.5	8.4	9.6	11.2	13.4	15.0

TO CALCULATE "X" DIMENSION:

SHORT SIDE (DOWN SLOPE): $X_S (FT) = \frac{\text{CURB FACE (FT)}}{\text{SIDE SLOPE} + \text{TC GRADE}}$

LONG SIDE (UP SLOPE): $X_L (FT) = \frac{\text{CURB FACE (FT)}}{\text{SIDE SLOPE} - \text{TC GRADE}}$

ENGINEER TO SHOW X_S AND X_L ON IMPROVEMENT PLANS

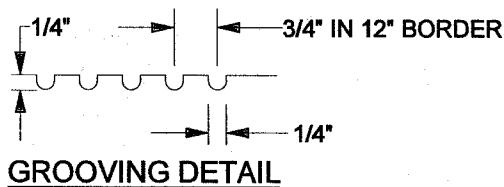

APPROVED BY:

George A. Johnson
 DIRECTOR OF TRANSPORTATION
 GEORGE A. JOHNSON, RCE 42328

DATE: 05/05/07

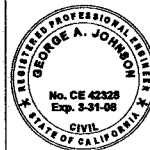

COUNTY OF RIVERSIDE

CURB RAMP

REVISIONS		REV.	BY:	APR'D	DATE	REV.	BY:	APR'D	DATE
8-77, 5-80	11-04	1				4			
10-81, 6-82		2				5			
9-88, 2-90		3				6			

STANDARD NO. 403 (3 OF 4)

CONSTRUCTION NOTES:

1. IF DISTANCE FROM CURB TO BACK OF SIDEWALK IS TOO SHORT TO ACCOMODATE RAMP AND 4' LANDING, THEN USE THE CASE "B" RAMP.
2. IF SIDEWALK IS LESS THAN 6' WIDE, THE FULL WIDTH OF THE SIDEWALK SHALL BE DEPRESSED AS SHOWN IN CASE B. MINIMUM SIDEWALK WIDTH IS 4' FROM BACK OF CURB.
3. THE RAMP SHALL HAVE A 12" WIDE BORDER WITH GROOVES 1/4" WIDE AND 1/4" DEEP APPROXIMATELY 3/4" ON CENTER. SEE GROOVING DETAIL.
4. TRANSITIONS FROM RAMPS TO WALKS, GUTTERS, OR STREETS SHALL BE FLUSH AND FREE OF ABRUPT CHANGES.
5. WHEN ABUTTING SOIL HAS A HIGH SULFATE CONTENT, SPECIAL CONSIDERATIONS ARE REQUIRED. SEE SPECIFICATIONS (SECTION 16.04).
6. RAMP SIDE SLOPE VARIES UNIFORMLY FROM A MAXIMUM OF UP TO 10% AT CURB TO CONFORM WITH LONGITUDINAL SIDEWALK SLOPE ADJACENT TO TOP OF THE RAMP (EXCEPT IN CASE B).
7. CONSTRUCT WEAKENED PLANE JOINTS AT 1/4 DELTAS WHEN RADIUS EQUALS 35' AND AT INSIDE EDGE OF GROOVED BORDER WHEN RADIUS EQUALS 25'.
8. IF EXPANSIVE SOIL IS ENCOUNTERED, THEN RAMP SHALL BE CONSTRUCTED OVER CLASS 2 AGGREGATE MATERIAL.
9. CONCRETE SHALL BE CLASS B.
10. MAXIMUM SLOPES OF ADJOINING GUTTERS: THE ROAD SURFACE IMMEDIATELY ADJACENT TO THE CURB RAMP AND CONTINUOUS PASSAGE TO THE CURB RAMP SHALL NOT EXCEED 5% WITHIN 4' OF THE BOTTOM OF THE CURB RAMP.
11. DETECTABLE WARNING SURFACES ARE REQUIRED ON ALL CURB RAMPS THAT ENTER INTO A VEHICULAR TRAVEL WAY.

APPROVED BY:

George A. Johnson

DATE: 11/15/04

DIRECTOR OF TRANSPORTATION
GEORGE A. JOHNSON, RCE 42328

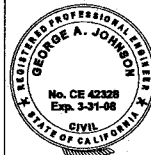

COUNTY OF RIVERSIDE

**CURB RAMP
CONSTRUCTION NOTES**

REVISIONS		REV.	BY:	APR'D	DATE	REV.	BY:	APR'D	DATE
8-77, 5-80	11-04	1				4			
10-81, 6-82		2				5			
9-88, 2-90		3				6			

12-97

STANDARD NO. 403 (4 OF 4)

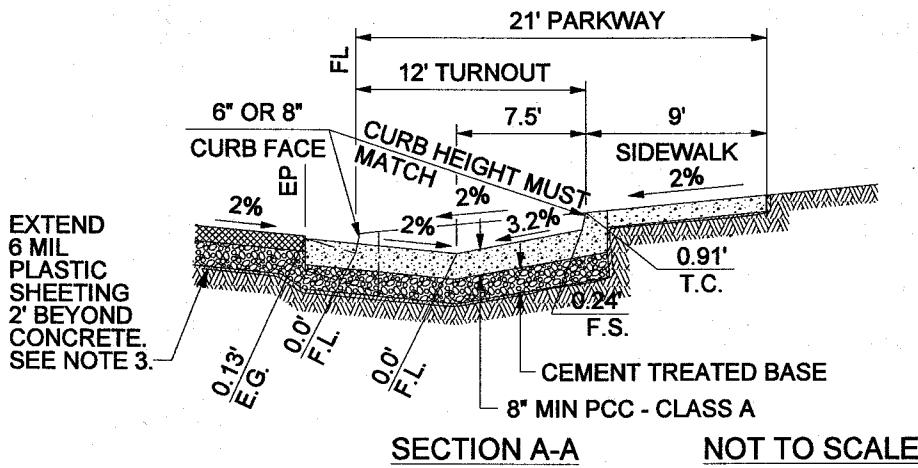
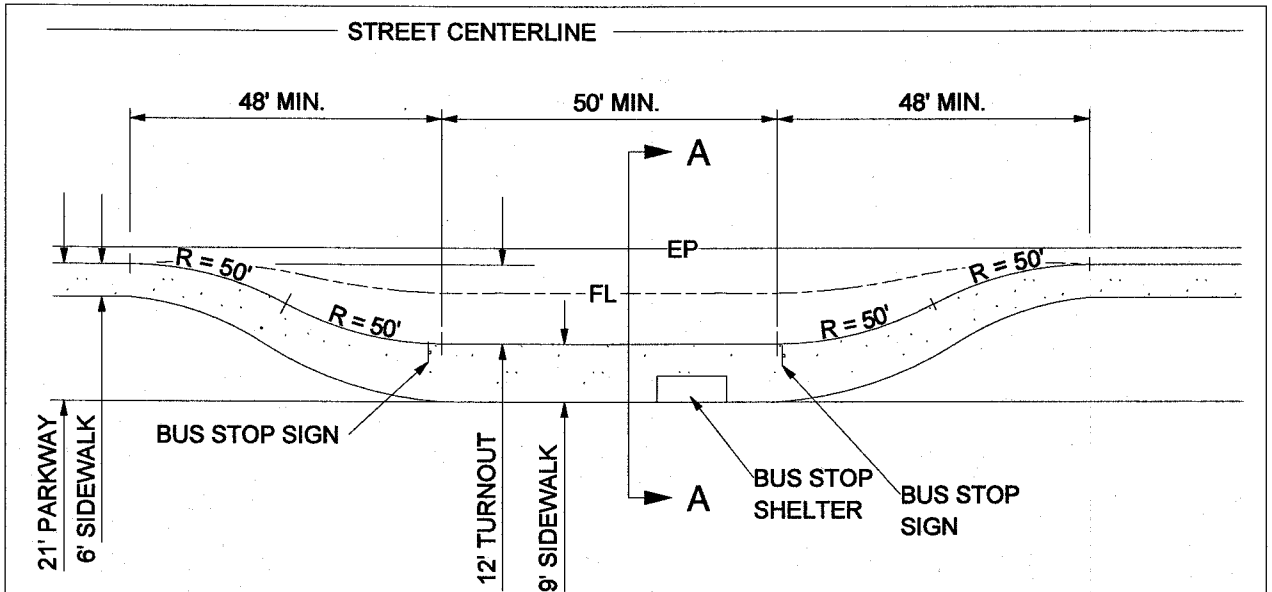

CURB DATA

R = 50'
 $\Delta = 28^\circ 21' 27''$
 L = 24.75'
 T = 12.63'

NOTES:

1. THICKNESS OF PCC AND BASE DEPENDS UPON ADT VOLUME AND SOIL TYPE. STRUCTURAL SECTION CALCULATIONS ARE REQUIRED.
2. LOCATION OF BUS TURNOUT SHOULD BE AS APPROVED BY THE TRANSPORTATION DEPARTMENT, AND IN CONSULTATION WITH THE APPROPRIATE TRANSIT AGENCY. (FAR SIDE BUS TURNOUT IS THE PREFERRED LOCATION):

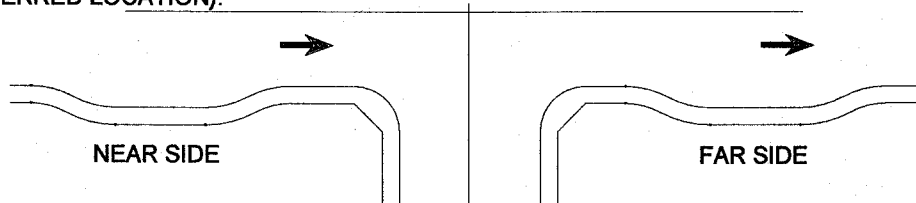

3. WHEN ABUTTING SOIL HAS A HIGH SULFATE CONTENT, SPECIAL CONSIDERATIONS ARE REQUIRED. SEE SPECIFICATIONS (SECTION 16.04).

APPROVED BY:

George A. Johnson
 DIRECTOR OF TRANSPORTATION
 GEORGE A. JOHNSON, RCE 42328

DATE: 05/01/07

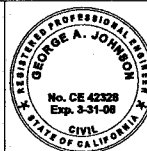

COUNTY OF RIVERSIDE

BUS TURNOUT

REVISIONS		REV.	BY:	APR'D	DATE	REV.	BY:	APR'D	DATE
11-04		1				4			
		2				5			
		3				6			

12-97

STANDARD NO. 814

