

209B



SUBMITTAL TO THE FLOOD CONTROL AND WATER CONSERVATION DISTRICT BOARD OF SUPERVISORS COUNTY OF RIVERSIDE, STATE OF CALIFORNIA

FROM: General Manager-Chief Engineer

SUBMITTAL DATE:
June 16, 2015

SUBJECT: Adopt Resolution No. F2015-26 - Setting a Public Hearing for the North Norco Channel, Stage 11 Project Pursuant to Section 18 of the District Act, Project No. 2-0-000140-11, District 2 [\$0]

RECOMMENDED MOTION: That the Board of Supervisors:

1. Adopt Resolution No. F2015-26 which sets July 21, 2015 as the date for a public hearing concerning the approval of the above referenced project in accordance with Section 18 of the District Act; and
2. Direct the Clerk of the Board to advertise and post said notice of public hearing to approve the project in accordance with Section 18 of the Riverside County Flood Control and Water Conservation District Act.

BACKGROUND:

Summary

Section 18 of the Riverside County Flood Control and Water Conservation District Act requires the Board of Supervisors to hold a public hearing for the purpose of considering all comments regarding any proposed facilities before authorizing the construction of such facilities.

JMV:mcv
P8\170164

WARREN D. WILLIAMS
General Manager-Chief Engineer

FINANCIAL DATA	Current Fiscal Year:	Next Fiscal Year:	Total Cost:	Ongoing Cost:	POLICY/CONSENT (per Exec. Office)
COST	\$ N/A	\$ N/A	\$ N/A	\$ N/A	Consent <input type="checkbox"/> Policy <input type="checkbox"/>
NET DISTRICT COST	\$ N/A	\$ N/A	\$ N/A	\$ N/A	

SOURCE OF FUNDS: N/A	Budget Adjustment: N/A
	For Fiscal Year: N/A

C.E.O. RECOMMENDATION:

County Executive Office Signature

MINUTES OF THE FLOOD CONTROL AND WATER CONSERVATION DISTRICT

On motion of Supervisor Ashley, seconded by Supervisor Benoit and duly carried by unanimous vote, IT WAS ORDERED that the above matter is approved as recommended, and is set for public hearing on Tuesday, July 21, 2015, at 10:30 a.m.

Ayes: Jeffries, Tavaglione, Washington, Benoit and Ashley
Nays: None
Absent: None
Date: June 16, 2015
xc: Flood, COB

Kecia Harper-Ihem
Clerk of the Board
By
Deputy

Prev. Agn. Ref.:

District: 2nd

Agenda Number:

11-2

FORM APPROVED BY COUNTY COUNSEL
BY:
DATE: 6-2-15
ANITA C. WILLIS

Departmental Concurrence

- A-30
- Positions Added
- 4/5 Vote
- Change Order

**SUBMITTAL TO THE FLOOD CONTROL AND WATER CONSERVATION DISTRICT
BOARD OF SUPERVISORS, COUNTY OF RIVERSIDE, STATE OF CALIFORNIA**

FORM 11: Adopt Resolution No. F2015-26 - Setting a Public Hearing for the North Norco Channel, Stage 11 Project Pursuant to Section 18 of the District Act, Project No. 2-0-000140-11, District 2 [\$0]

DATE: June 16, 2015

PAGE: Page 2 of 2

BACKGROUND:

Summary (continued)

The Riverside County Flood Control and Water Conservation District (District) proposes to construct, operate and maintain the North Norco Channel, Stage 11 Project (project). The project area is currently served by an unlined flood control channel that does not have 100-year flood capacity. Therefore, the project is designed to provide 100-year flood protection, allow revision of the Federal Emergency Management Agency mapping of Flood Hazard Areas and provide safe access across the road crossings at Sixth Street, Valley View Avenue and Corona Avenue. The proposed facilities consist of improvements to an aboveground channel (the North Norco Channel, or mainline) and installation of several underground storm drains (or laterals) that would feed into the channel. The project totals approximately 5,912 lineal feet of drainage improvements. These facilities would be constructed in phases; however, for the purpose of the environmental assessment, are collectively referred to as the North Norco Channel, Stage 11 Project. The cost of implementing the project is estimated at \$7,690,000 and is included in the District's Zone 2 budget.

In accordance with the California Environmental Quality Act, the District prepared and circulated an Initial Study for this project, which analyzes potential impacts it may have on the environment. The result of the Initial Study shows this project, with the incorporation of feasible mitigation, will not significantly impact the environment and a Mitigated Negative Declaration (MND) is proposed. On July 21, 2015, the date of the Section 18 public hearing, the Board will consider the MND under Resolution No. F2015-27.

Impact on Residents and Businesses

N/A

ATTACHMENTS (if needed, in this order):

1. Resolution No F2015-26
2. Project Map (Attachment "A")
3. Channel and Storm Drain Cross-Sections (Attachment "B")
4. Engineer's Statement (Attachment "C")

P8\170164

1
2 Board of Supervisors

Riverside County Flood Control
and Water Conservation District

3 **RESOLUTION NO. F2015-26**
4 **SETTING A PUBLIC HEARING DATE FOR**
5 **NORTH NORCO CHANNEL, STAGE 11 PROJECT**
6 **IN ACCORDANCE WITH SECTION 18 OF THE**
7 **RIVERSIDE COUNTY FLOOD CONTROL AND**
8 **WATER CONSERVATION DISTRICT ACT**

9 WHEREAS, Act 6642 of the State Legislature, Section 18 of the Riverside County Flood
10 Control and Water Conservation District Act ("District Act") requires that the Riverside County
11 Flood Control and Water Conservation District ("District") give public notice and conduct a
12 public hearing prior to undertaking construction of District facilities; and

13 WHEREAS, this Board of Supervisors ("Board") intends to undertake a project within
14 the city of Norco designated as the North Norco Channel, Stage 11 Project ("Project"); and

15 WHEREAS, the Project is generally bounded to the south by Mulberry Lane, to the west
16 by Sierra Avenue, to the north by Seventh Street, and to the east by Temescal Avenue; and

17 WHEREAS, the Project consists of the replacement of the existing interim earthen
18 channel with a combination of soft-bottom concrete-lined trapezoidal/concrete rectangular open
19 channels and construction of underground storm drains Line N-2, Line NC and Lateral NC-1
20 designed to provide 100-year flood protection; and

21 WHEREAS, reference is made to a Section 18 Map, dated June 2015 (Attachment "A"),
22 bearing the name and showing the general location and typical cross sections (Attachment "B")
23 of the Project which are also on file with the Clerk of the Board; and

24 WHEREAS, reference is made to the engineering cost estimate of the Project, entitled
25 "Engineer's Statement" (Attachment "C") on file with the Clerk of the Board; and
26
27
28

FORM APPROVED COUNTY COUNSEL
BY: Aaron C. Gettis 6-2-15
DATE

1 WHEREAS, in accordance with the California Environmental Quality Act (CEQA), the
2 District prepared an Initial Study which demonstrates that, with the incorporation of required
3 mitigation, the Project will not have a significant physical impact on the environment and,
4 therefore, a Mitigated Negative Declaration (MND) is proposed; and

5 WHEREAS, the Initial Study and MND (SCH No. 2015041069) were circulated for a 30-
6 day public review period from April 21, 2015 through May 20, 2015 pursuant to CEQA; and

7 WHEREAS, on July 21, 2015, the date of the Section 18 Public Hearing, the Board will
8 consider the MND under Resolution No. F2015-27; and

9 WHEREAS, the Section 18 map and the Engineer's Statement for the Project are posted
10 on the District's website at <http://rcflood.org> under the CEQA/Section 18 tab and may be
11 inspected at the District's office located at 1995 Market Street, Riverside, California 92501 or at
12 Norco Public Library located at 3954 Old Hamner Road, Norco, California 92860; and

13 WHEREAS, pursuant to Section 18 of the District Act, prior to making a decision on the
14 Project, this Board will consider all written and oral comments; and

15 WHEREAS, pursuant to Section 18 of the District Act, any person wishing to comment
16 on the Project may do so in writing between the date of this notice and the public hearing, or may
17 appear and be heard at the time and place noted below.

18 NOW, THEREFORE, BE IT RESOLVED, DETERMINED AND ORDERED by the
19 Board of Supervisors of the Riverside County Flood Control and Water Conservation District in
20 regular session assembled on June 16, 2015 that:

21 1. A public hearing pertaining to the North Norco Channel, Stage 11 Project will be
22 held in accordance with Section 18 of the District Act on July 21, 2015 at 10:30 a.m., or as soon
23 as possible thereafter, at the meeting room of this Board, 1st Floor, County Administrative
24
25
26
27
28

1 Center, 4080 Lemon Street, Riverside, California, 92501 at which time all public comments shall
2 be heard.

3 2. The District shall cause a copy of this resolution and copies of the map and
4 Engineer's Statement to be posted at least 21 days before said hearing at the Norco Public
5 Library located at 3954 Old Hamner Road, Norco, California 92860.

6 3 The District shall cause a copy of this resolution and copies of the map and
7 Engineer's Statement to be posted at least 21 days before said hearing at the Riverside County
8 Flood Control and Water Conservation District located at 1995 Market Street, Riverside,
9 California 92501.

10 4. The District shall cause a copy of this resolution to be posted at least 21 days before
11 said hearing at the Riverside County Clerk and Recorder's Office, 2724 Gateway Drive,
12 Riverside, California 92507.

13 5. The Clerk of this Board is directed to cause a copy of this resolution to be published
14 twice, once at least 21 days before said hearing and once 7 days following the initial publication,
15 in a newspaper of general circulation in accordance with Section 18 of the District Act.

16 ROLL CALL:

17 Ayes: Jeffries, Tavaglione, Washington, Benoit and Ashley
18 Nays: None
19 Absent: None

20 The foregoing is certified to be a true copy of a resolution duly
21 adopted by said Board of Supervisors on the date therein set forth.

22
23 KECIA HARPER IHEM, Clerk of said Board
24 By  Deputy

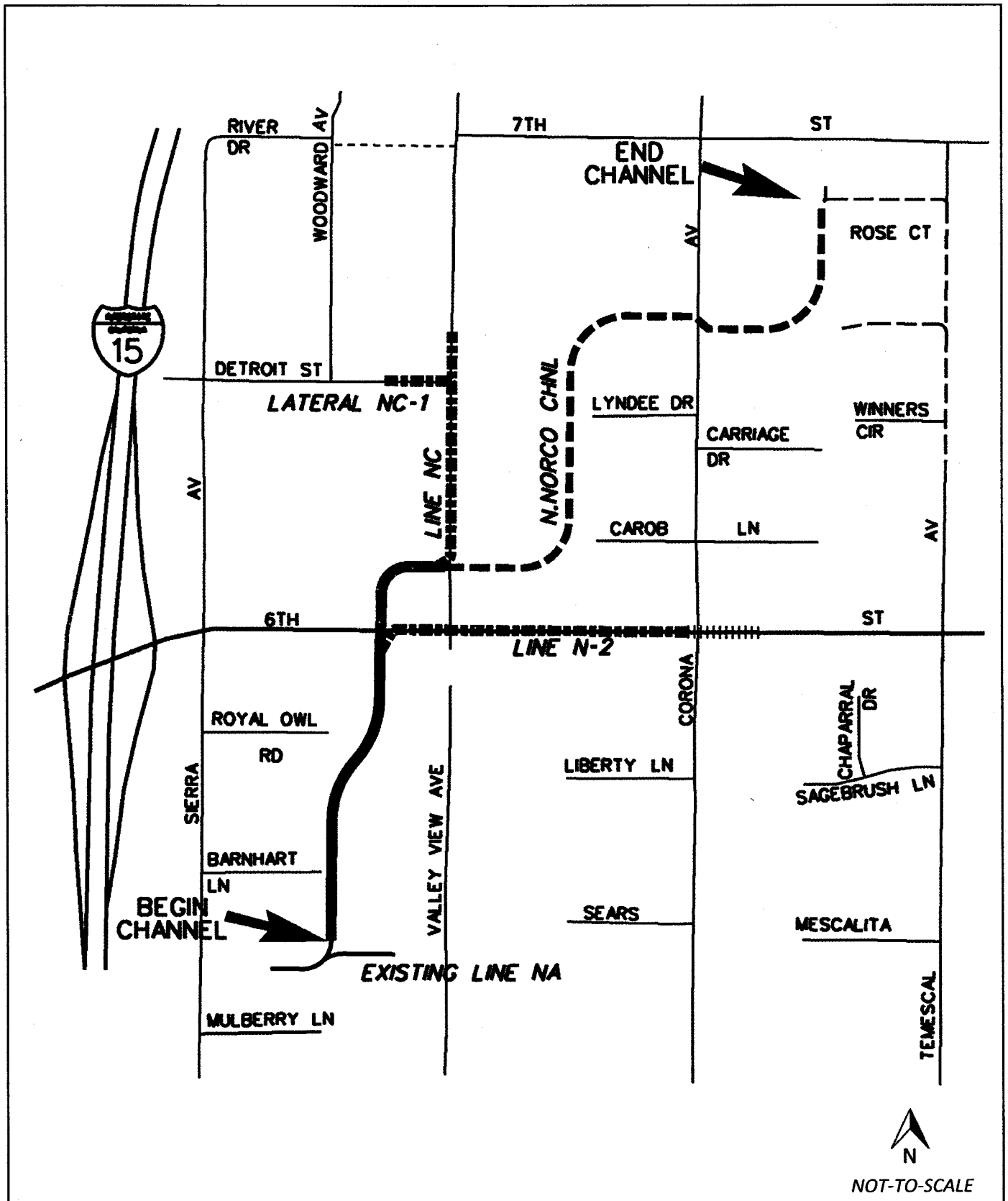

SECTION 18 MAP

North Norco Channel, Stage 11
 PROJECT NUMBER: 2-8-00140-11-30-0000-000

June 2015

LEGEND

- SOFT-BOTTOM TRAP. CHNL
- CONCRETE RECT. CHNL
- STORM DRAIN CONCRETE BOX
- STORM DRAIN CONCRETE PIPE

Typical Trapezoidal Channel Section

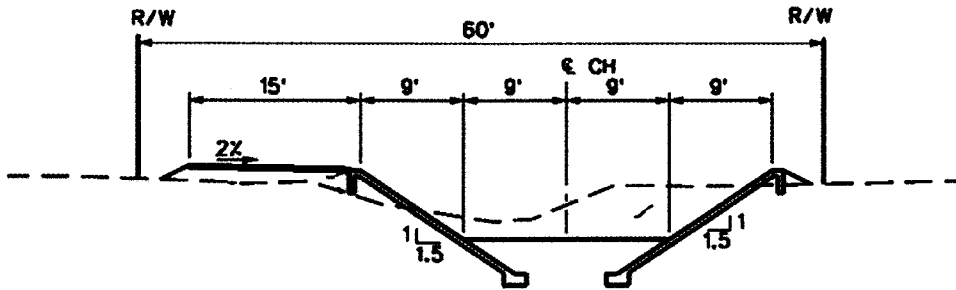

Typical Rectangular Channel Section

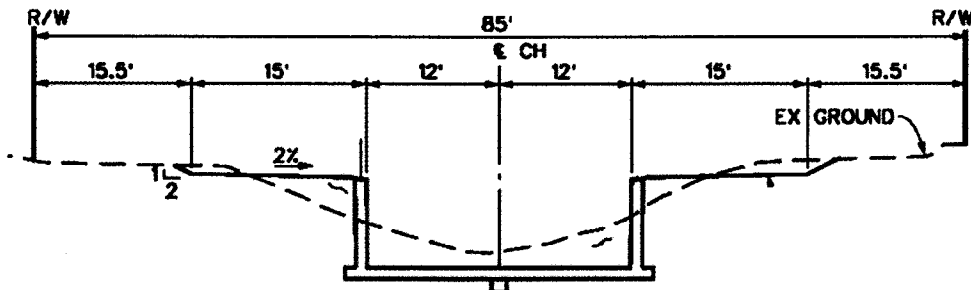

Typical Reinforced Concrete Box Section

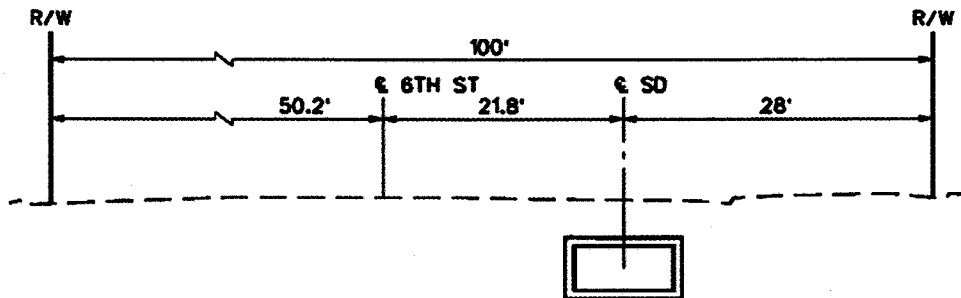

Typical Reinforced Concrete Pipe Section

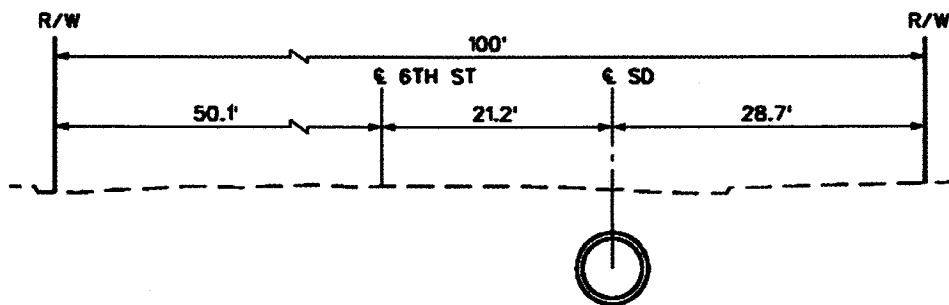

NOT-TO-SCALE



SECTION 18 CROSS SECTIONS

North Norco Channel, Stage 11

PROJECT NUMBER: 2-8-00140-11-30-0000-000

June 2015

Engineer's Statement

North Norco Channel, Stage 11	222-2-8-00140-11
North Norco Channel, Line N-2, Stage 1	222-2-8-00144-01
Norco MDP, Line NC, Stage 1	222-2-8-00078-01
Norco MDP, Lateral NC-1, Stage 1	222-2-8-00080-01

The proposed projects are located in the City of Norco, Riverside County, California. North Norco Channel Stage 11 is an ultimate storm drain system designed to collect runoff from an 817- acre watershed located north of the confluence with Line NA. When complete, North Norco Channel will provide 100-year flood protection.

The main line of proposed North Norco Channel consists of approximately 5,912 lineal feet of channel. Downstream of Valley View Avenue, approximately 2,384 lineal feet of reinforced concrete lined rectangular channel is proposed with 8 feet high walls and a base width of 24 feet. Upstream of Valley View Avenue, approximately 3,527 lineal feet of concrete lined revetment with earthen bottom is proposed and ranges in height from 7 to 6 feet, width of 18 feet and side slopes of 1.5 to 1.

North Norco Channel – Line N-2 Stage 1 is an ultimate storm drain system designed to collect runoff from a 45-acre watershed located along 6th Street from Valley View Avenue to Corona Avenue and convey it to the improved North Norco Channel. MDP Line N-2 Stage 1 consists of approximately 1,500 lineal feet of 9-feet wide by 4-feet high reinforced concrete box culvert, approximately 150 lineal feet of 7-feet wide by 4-feet high reinforced concrete box culvert and 170 feet of 48-inch reinforced concrete pipe. When complete, Line N-2 Stage 1 storm drain will provide 100-year flood protection.

Norco MDP Line NC Stage 1 is an ultimate storm drain system designed to collect runoff from a 147-acre watershed along Valley View Avenue and convey it to the improved North Norco Channel. The proposed Norco MDP Line NC Stage 1 consists of 985 lineal feet of 8-feet wide by 4-feet high reinforced concrete box and 255 lineal feet of 5-feet wide by 4-feet high reinforced concrete box. When complete and once the existing streets are improved with curb and gutter, Line NC Stage 1 storm drain will provide 100-year flood protection.

Norco MDP Lateral NC-1 Stage 1 is an ultimate storm drain system designed to collect runoff from a 46-acre watershed located along Detroit Avenue and convey it to the proposed Line NC. The proposed Norco MDP Lateral NC-1 Stage 1 consists of 265 lineal feet of a 6-feet wide by 3-feet high reinforced concrete box. When complete and once the existing streets are improved with curb and gutter, Lateral NC-1 Stage 1 storm drain will provide 100-year flood protection.

The cost of the combined projects is approximately \$7,690,000.



The Riverside County Record Newspaper

Western Riverside County's Only Hometown Newspaper

Since 1955

Post Office Box 3187 • Riverside, California 92519

951685-6191 • FAX 951685-2961

e-mail: recorddhab@aol.com

INVOICE

June 25, 2015

Riverside County
Clerk of the Board
P.O. Box 1147
Riverside, CA 92502- 1147

Attn: Kecia Harper-Ihem

Legal Advertising,

Notice to Public Hearing

Your# Flood Control and Water Conservation District
Resolution No. F2015-26
Our # 0497

47.50 column inches x \$8.94 = \$424.65 x 2 = \$849.30

Publish: two (2) week: June 25, 2015;
July 2, 2015

Amount Due: \$849.30

Thank You,

Cathy Sypin-Barnes

Flood
11-2 of 06/16/15

Affidavit of Publication

(2015.5 C.C.P.)

County of Riverside

State of California

Catherine Sy-pin-Barnes, being first duly sworn, deposes and says all times hereinafter, mentioned that she was a citizen of the United States...

RIVERSIDE COUNTY RECORD NEWSPAPER

of which the annexed is a printed copy, published and printed in said newspaper in at least 2 weekly issue, as follows:

June 25, 2015; July 2, 2015

I certify (or declare) under penalty of perjury that the foregoing is true and correct.

Signature of Catherine Sy-pin-Barnes

Dated: July 2, 2015 at Riverside, California

NOTICE OF PUBLICATION, SUPERVISORS OF THE COUNTY OF RIVERSIDE, STATE OF CALIFORNIA...

The following persons are: (1) Home Helping Hands, (2) H.H.H., (3) H.H.H.C. 6800 Indiana Ave. Suite 200, Milwan Corporation, 15830 Rawhide Lane, Riverside, CA...

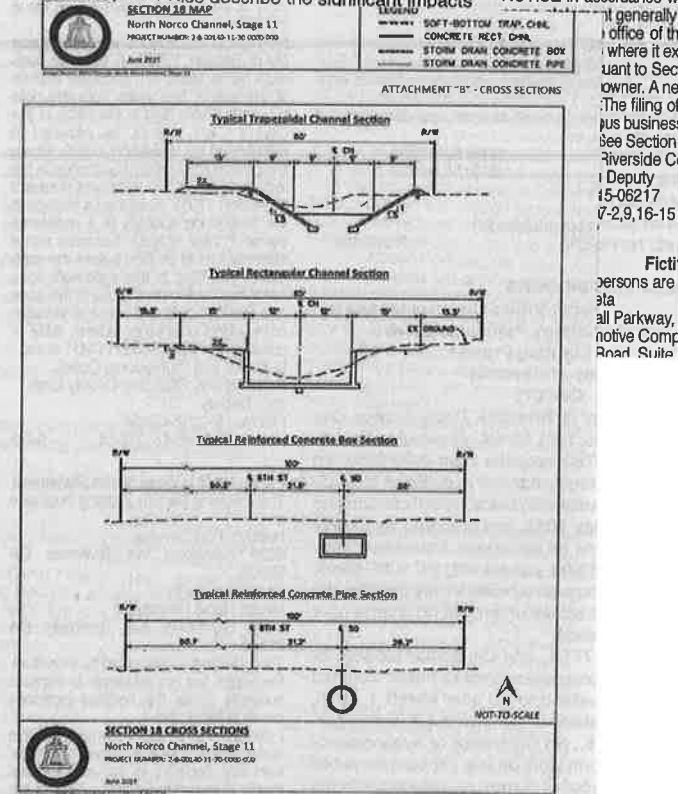

Engineer's Statement: North Norco Channel, Stage 1 (222-2-8-00140-11), North Norco Channel, Line N-2, Stage 1 (222-2-8-00144-01), Norco MDP, Line NC, Stage 1 (222-2-8-00078-01), Norco MDP, Lateral NC-1, Stage 1 (222-2-8-00080-01). The proposed projects are located in the City of Norco, Riverside County, California...