

SUBMITTAL TO THE BOARD OF SUPERVISORS
COUNTY OF RIVERSIDE, STATE OF CALIFORNIA

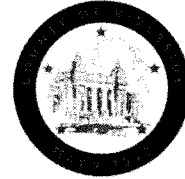

ITEM
3.34
(ID # 6540)

MEETING DATE:

Tuesday, April 10, 2018

FROM : TLMA-TRANSPORTATION:

SUBJECT: TRANSPORTATION AND LAND MANAGEMENT AGENCY - TRANSPORTATION

DEPARTMENT: Approve Addenda to the Plans and Specifications, Accept the Low Bid and Award the Contract for the Construction of Mecca Area Sidewalks Project, in the Community of Mecca. 4th District; [\$536,546 total cost]; State Funds 90%, Local Funds 10%.

RECOMMENDED MOTION: That the Board of Supervisors:

1. Approve two addenda to the plans and specifications issued prior to the February 7, 2018, bid opening; and
2. Accept the low bid of CT&T Concrete Paving, Inc. of Brea, CA in the amount of \$536,546; and
3. Award the contract to CT&T Concrete Paving, Inc. and authorize the Chairman of the Board to execute the contract documents.

ACTION: Policy

Patricia Romo, Director of Transportation 3/12/2018

MINUTES OF THE BOARD OF SUPERVISORS

On motion of Supervisor Jeffries, seconded by Supervisor Perez and duly carried by unanimous vote, IT WAS ORDERED that the above matter is approved as recommended.

Ayes: Jeffries, Tavaglione, Washington, Perez and Ashley
Nays: None
Absent: None
Date: April 10, 2018
xc: Transp.

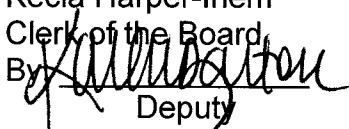
Kecia Harper-Ihem
Clerk of the Board
By 
Deputy

**SUBMITTAL TO THE BOARD OF SUPERVISORS COUNTY OF RIVERSIDE,
STATE OF CALIFORNIA**

FINANCIAL DATA	Current Fiscal Year:	Next Fiscal Year:	Total Cost:	Ongoing Cost
COST	\$ 536,546	\$ 0	\$ 536,546	\$ 0
NET COUNTY COST	\$ 0	\$ 0	\$ 0	\$ 0
SOURCE OF FUNDS: Gas Tax / HUTA (10%), Active Transportation Plan (ATP) (90%). There are no General Funds used in this project.			Budget Adjustment: No	
			For Fiscal Year: 17/18	

C.E.O. RECOMMENDATION: Approve

BACKGROUND:

Summary

By Minute Order dated January 9, 2018 (Agenda Item 3.33), the County of Riverside (County) Board of Supervisors authorized the Clerk of the Board to advertise for the construction of the Mecca Area Sidewalks Project, in the Community of Mecca of the County of Riverside. The following roads will be improved with this project.

1. 6th Street (Date Palm Street to Dale Kiler Road)
2. Brown Street (5th Street to 6th Street)
3. Dale Kiler Road (5th Street to 7th Street)

The work includes constructing sidewalk including curb and gutter, driveways and Americans with Disabilities Act (ADA) compliant curb ramps.

Additional improvements will include removal and replacement of existing curb, gutter and sidewalk, reconstruction of driveways, cross gutter, removal of trees, relocation of roadside signs, placement of painted traffic stripe and thermoplastic pavement marking and other associated work.

During the advertisement period, two addenda were issued to all registered plan holders as a supplement to the plans and specifications. Bidders were required to acknowledge and take into account all issued addenda on their contractor's Bid in order to be considered for award. The Addendum 1 was issued to extend the bid receipt date and Addendum 2 was issued to clarify and modify the approved contract documents. The addenda are attached and designated as Addendum No. 1 and Addendum No. 2.

The contractor, CT&T, Inc. is qualified to perform the work as outlined in the bid, has executed the contract, and has provided bonds and insurance documents which meet the requirements of the Contract.

Project No.: C6-0069
State project No. ATPL-5956(258)

**SUBMITTAL TO THE BOARD OF SUPERVISORS COUNTY OF RIVERSIDE,
STATE OF CALIFORNIA**

Impact on Residents and Businesses

The project is intended to provide improvements to the disadvantaged community of Mecca to enhance public health, increase mobility for non-motorized users, increase public safety, and reduce greenhouse gases effect through active modes of transportation. The construction of improved pedestrian routes on 6th Street, Brown Street, and Dale Kiler Road will benefit many residents in the area who walk to the Churches and Sports Complex in the immediate vicinity, as well as connectivity to the existing sidewalks that leads to downtown for services including the schools, bus stops, market place, medical clinic, library, post office and Boys & Girls Club.

The work is scheduled to begin in Spring of 2018 and will take approximately two months to complete.

SUPPLEMENTAL:

Additional Fiscal Information

The contract is recommended to be awarded to CT&T, Inc. for the total amount of \$536,546.

The project will be funded with Gas Tax / HUTA and Active Transportation Plan (ATP) funds for which the Transportation Department successfully completed.

The project is expected to be finished within the existing budget as shown on Attachment "A".

There is no General Funds used in this project.

Contract History and Price Reasonableness

Six bids were received ranging from \$536,546 to \$948,827. The basis for the selection of a contractor is the lowest responsive and responsible bid.

All received bids were responsive to the bidding requirements set forth for the project. The lowest responsible bid was submitted by CT&T, Inc. in the amount of \$536,546 which is \$13,866 (2.5%) below the Engineer's Estimate.

ATTACHMENTS:

- Vicinity Map
- Attachment A
- Contract/Lease/Purchase Summary Data
- Summary of Bids
- Addendum No. 1 and 2
- Contract/Bonds/Insurance
- Contractor's Bid Proposal

SUBMITTAL TO THE BOARD OF SUPERVISORS COUNTY OF RIVERSIDE,
STATE OF CALIFORNIA

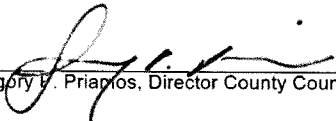

Gregory V. Priaplos, Director County Counsel 3/15/2018

COUNTY OF RIVERSIDE
TRANSPORTATION DEPARTMENT

MECCA AREA

SIDEWALKS

**6TH ST FROM DATE PALM ST TO DALE KILER RD
BROWN ST FROM 5TH ST TO 6TH ST
DALE KILER RD FROM 5TH ST TO 7TH ST**

COMMUNITY OF MECCA

WO No. C6-0069

TO BE SUPPLEMENTED BY CALTRANS STANDARD PLANS DATED 2015 AND
COUNTY OF RIVERSIDE ROAD IMPROVEMENT STANDARDS DATED 12-20-2007

STATE PROJECT No. ATPL-5956 (258)

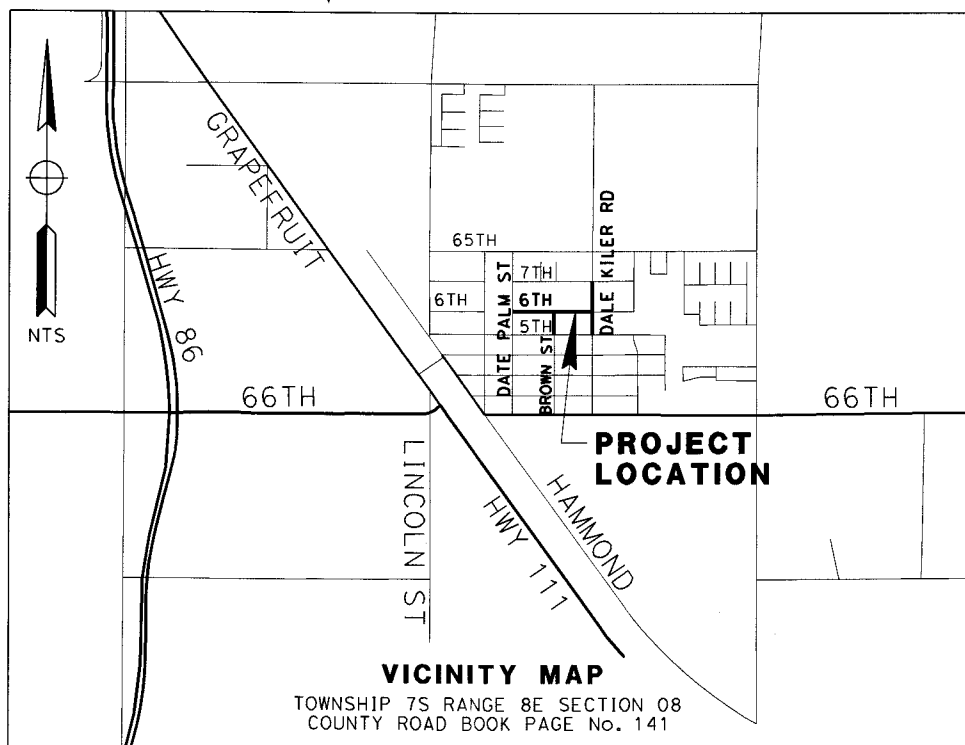
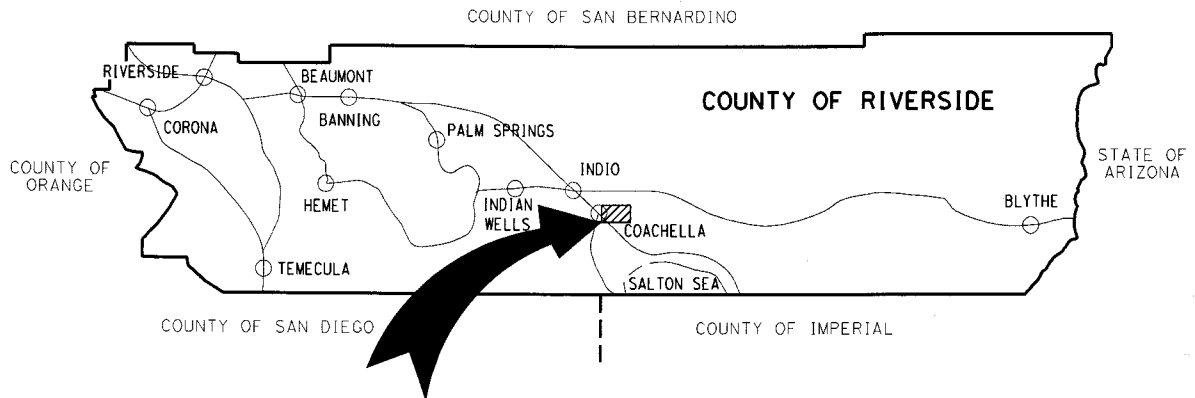

Attachment "A"

Riverside County Transportation Department

Project: **MECCA AREA
SIDEWALKS**

Project No.(s): **C6-0069**

Expenses as of: **2/26/2018**

Project Costs and Budget

Activity	Incurred Costs	Projected Costs	Total Costs	Existing Budget
Preliminary Survey	35,504		36,000	33,000
Environmental	4,305		5,000	1,000
Design	99,013		100,000	126,000
Right-of-way				
Utilities				
Construction		536,546		
Construction Contingency 10.0%		53,655	591,000	680,000
Construction Engineering & Inspection		91,000	91,000	91,000
Construction Survey		45,000	45,000	45,000
Totals:	138,822	726,201	868,000	976,000

Project Funding

Code	Name	Existing Budget
221	Gas Tax/HUTA	125,000
256	Active Transportation Plan (ATP) - State	851,000
Totals		976,000

Comments

Riverside County Transportation Department
Summary of Bids

Advertised: January 9, 2018 (Agenda Item: 3.33)
 Addenda: 1 (1/25/2018), 2(2/2/2018)
 Bids Open: 2 pm Date: Wednesday, February 7, 2018

PROJECT:
 Mecca Area Sidewalks Project
 Community of Mecca
 Project No. C6-0069
 State Project No. ATPL-5956(258)

BASE BID SCHEDULE		COUNTY'S ESTIMATE				CT&T Concrete Paving, Inc. Diamond Bar, CA 91765		
ITEM NO.	ITEM CODE	CONTRACT ITEM	UNITS	QUANTITY	UNIT PRICE	ENG ESTIMATE	BID UNIT PRICE	BID ESTIMATE
1	066102	DUST ABATEMENT	LS	1	5,000.00	5,000.00	5,000.00	5,000.00
2	074020	WATER POLLUTION CONTROL	LS	1	5,000.00	5,000.00	2,000.00	2,000.00
3	100100	DEVELOP WATER SUPPLY	LS	1	5,000.00	5,000.00	4,500.00	4,500.00
4	120100	TRAFFIC CONTROL SYSTEM	LS	1	15,000.00	15,000.00	6,000.00	6,000.00
5	170103	CLEARING AND GRUBBING	LS	1	5,000.00	5,000.00	8,000.00	8,000.00
6	011503	UNDER SIDEWALK DRAIN CAST IN PLACE (CRS 309)	EA	6	2,000.00	12,000.00	200.00	1,200.00
7	190101	ROADWAY EXCAVATION	CY	180	45.00	8,100.00	79.00	14,220.00
8	260203	CLASS 2 AGGREGATE BASE	CY	1,880	45.00	84,600.00	25.00	47,000.00
9	390130	HOT MIX ASPHALT	TON	390	120.00	46,800.00	112.00	43,680.00
10	015602	FUNDING AWARENESS SIGN	EA	5	1,000.00	5,000.00	750.00	3,750.00
11	017302	MINOR CONCRETE (CROSS-GUTTER) (CRS 209)	SQFT	1,000	7.00	7,000.00	12.00	12,000.00
12	017303	MINOR CONCRETE (SPANDREL) (CRS 209)	SQFT	2,000	15.00	30,000.00	14.00	28,000.00
13	017304	MINOR CONCRETE (CURB AND GUTTER) (CRS 200)	LF	3,500	20.00	70,000.00	40.00	140,000.00
14	017310	MINOR CONCRETE (DRIVEWAY APPROACH) (CRS 207)	SQFT	6,000	8.00	48,000.00	7.00	42,000.00
15	017315	MINOR CONCRETE (CURB RAMP) (CRS 403 - CASE A)	EA	3	2,800.00	8,400.00	3,000.00	9,000.00
16	017316	MINOR CONCRETE (CURB RAMP) (CRS 403 - CASE B)	EA	4	2,800.00	11,200.00	3,400.00	13,600.00
17	731516	MINOR CONCRETE (DRIVEWAY)	SQFT	2,035	8.00	16,280.00	7.00	14,245.00
18	731521	MINOR CONCRETE (SIDEWALK)	SQFT	16,000	8.00	128,000.00	5.65	90,400.00
19	803050	REMOVE (AND REPLACE) CHAIN LINK FENCE	LF	275	5.00	1,375.00	40.00	11,000.00
20	810230	PAVEMENT MARKER (RETROREFLECTIVE)	EA	6	4.00	24.00	99.00	594.00
21	820610	RELOCATE ROADSIGN SIGNS	EA	10	200.00	2,000.00	242.00	2,420.00
22	840519	THERMOPLASTIC CROSSWALK AND PAVEMENT MARKING	SQFT	260	5.00	1,300.00	6.60	1,716.00
23	840656	PAINT TRAFFIC STRIPE (2-COAT)	LF	1,110	0.30	333.00	1.10	1,221.00
24	010602	MISCELLANEOUS WORK (AS DIRECTED)	FA	1	35,000.00	35,000.00	35,000.00	35,000.00
TOTAL, ITEMS 1 - 24						550,412.00		536,546.00

Riverside County Transportation Department
Summary of Bids

Advertised: January 9, 2018 (Agenda Item: 3.33)

Addenda: 1 (1/25/2018), 2(2/2/2018)

Bids Open: 2 pm Date: Wednesday, February 7, 2018

PROJECT:

Mecca Area Sidewalks Project
 Community of Mecca
 Project No. C6-0069
 State Project No. ATPL-5956(258)

BASE BID SCHEDULE		CONTRACT ITEM	UNITS	QUANTITY	Tri Star Contracting II, Inc. Desert Hot Springs, CA 92240		All American Asphalt Corona, CA 92878	
ITEM NO.	ITEM CODE				BID UNIT PRICE	BID ESTIMATE	BID UNIT PRICE	BID ESTIMATE
1	066102	DUST ABATEMENT	LS	1	35,091.00	35,091.00	29,566.00	29,566.00
2	074020	WATER POLLUTION CONTROL	LS	1	4,844.00	4,844.00	21,514.00	21,514.00
3	100100	DEVELOP WATER SUPPLY	LS	1	1,211.00	1,211.00	2,909.00	2,909.00
4	120100	TRAFFIC CONTROL SYSTEM	LS	1	38,510.00	38,510.00	22,026.00	22,026.00
5	170103	CLEARING AND GRUBBING	LS	1	18,969.00	18,969.00	4,605.00	4,605.00
6	011503	UNDER SIDEWALK DRAIN CAST IN PLACE (CRS 309)	EA	6	6,057.00	36,342.00	4,248.00	25,488.00
7	190101	ROADWAY EXCAVATION	CY	180	70.00	12,600.00	108.00	19,440.00
8	260203	CLASS 2 AGGREGATE BASE	CY	1,880	38.00	71,440.00	56.90	106,972.00
9	390130	HOT MIX ASPHALT	TON	390	139.00	54,210.00	183.60	71,604.00
10	015602	FUNDING AWARENESS SIGN	EA	5	909.00	4,545.00	1,099.00	5,495.00
11	017302	MINOR CONCRETE (CROSS-GUTTER) (CRS 209)	SQFT	1,000	13.55	13,550.00	13.70	13,700.00
12	017303	MINOR CONCRETE (SPANDREL) (CRS 209)	SQFT	2,000	13.55	27,100.00	13.70	27,400.00
13	017304	MINOR CONCRETE (CURB AND GUTTER) (CRS 200)	LF	3,500	19.12	66,920.00	18.70	65,450.00
14	017310	MINOR CONCRETE (DRIVEWAY APPROACH) (CRS 207)	SQFT	6,000	7.79	46,740.00	11.3000	67,800.00
15	017315	MINOR CONCRETE (CURB RAMP) (CRS 403 - CASE A)	EA	3	3,114.00	9,342.00	7,018.20	21,054.60
16	017316	MINOR CONCRETE (CURB RAMP) (CRS 403 - CASE B)	EA	4	2,348.00	9,392.00	5,912.10	23,648.40
17	731516	MINOR CONCRETE (DRIVEWAY)	SQFT	2,035	6.48	13,186.80	11.20	22,792.00
18	731521	MINOR CONCRETE (SIDEWALK)	SQFT	16,000	5.20	83,200.00	6.60	105,600.00
19	803050	REMOVE (AND REPLACE) CHAIN LINK FENCE	LF	275	55.00	15,125.00	49.60	13,640.00
20	810230	PAVEMENT MARKER (RETROREFLECTIVE)	EA	6	13.00	78.00	33.00	198.00
21	820610	RELOCATE ROADSIGN SIGNS	EA	10	376.00	3,760.00	241.80	2,418.00
22	840519	THERMOPLASTIC CROSSWALK AND PAVEMENT MARKING	SQFT	260	14.70	3,822.00	6.60	1,716.00
23	840656	PAINT TRAFFIC STRIPE (2-COAT)	LF	1,110	2.20	2,442.00	1.10	1,221.00
24	010602	MISCELLANEOUS WORK (AS DIRECTED)	FA	1	35,000.00	35,000.00	35,000.00	35,000.00
TOTAL, ITEMS 1 - 24						607,419.80		711,257.00

Riverside County Transportation Department
Summary of Bids

Advised: January 9, 2018 (Agenda Item: 3.33)

Addenda: 1 (1/25/2018), 2(2/2/2018)

Bids Open: 2 pm Date: Wednesday, February 7, 2018

PROJECT:

Mecca Area Sidewalks Project
 Community of Mecca
 Project No. C6-0069
 State Project No. ATPL-5956(258)

BASE BID SCHEDULE		4		5				
ITEM NO.	ITEM CODE	CONTRACT ITEM	UNITS	QUANTITY	BID UNIT PRICE	BID ESTIMATE	BID UNIT PRICE	BID ESTIMATE
1	066102	DUST ABATEMENT	LS	1	6,761.90	6,761.90	25,026.00	25,026.00
2	074020	WATER POLLUTION CONTROL	LS	1	7,000.00	7,000.00	14,000.00	14,000.00
3	100100	DEVELOP WATER SUPPLY	LS	1	5,000.00	5,000.00	5,000.00	5,000.00
4	120100	TRAFFIC CONTROL SYSTEM	LS	1	37,000.00	37,000.00	30,000.00	30,000.00
5	170103	CLEARING AND GRUBBING	LS	1	40,000.00	40,000.00	5,000.00	5,000.00
6	011503	UNDER SIDEWALK DRAIN CAST IN PLACE (CRS 309)	EA	6	1,500.00	9,000.00	6,500.00	39,000.00
7	190101	ROADWAY EXCAVATION	CY	180	76.76	13,816.80	80.00	14,400.00
8	260203	CLASS 2 AGGREGATE BASE	CY	1,880	76.76	144,308.80	100.00	188,000.00
9	390130	HOT MIX ASPHALT	TON	390	123.00	47,970.00	115.00	44,850.00
10	015602	FUNDING AWARENESS SIGN	EA	5	1,000.00	5,000.00	600.00	3,000.00
11	017302	MINOR CONCRETE (CROSS-GUTTER) (CRS 209)	SQFT	1,000	13.00	13,000.00	18.00	18,000.00
12	017303	MINOR CONCRETE (SPANDREL) (CRS 209)	SQFT	2,000	13.00	26,000.00	18.00	36,000.00
13	017304	MINOR CONCRETE (CURB AND GUTTER) (CRS 200)	LF	3,500	35.35	123,725.00	35.00	122,500.00
14	017310	MINOR CONCRETE (DRIVEWAY APPROACH) (CRS 207)	SQFT	6,000	8.50	51,000.00	12.00	72,000.00
15	017315	MINOR CONCRETE (CURB RAMP) (CRS 403 - CASE A)	EA	3	4,000.00	12,000.00	3,000.00	9,000.00
16	017316	MINOR CONCRETE (CURB RAMP) (CRS 403 - CASE B)	EA	4	4,000.00	16,000.00	2,000.00	8,000.00
17	731516	MINOR CONCRETE (DRIVEWAY)	SQFT	2,035	8.50	17,297.50	12.00	24,420.00
18	731521	MINOR CONCRETE (SIDEWALK)	SQFT	16,000	6.50	104,000.00	11.00	176,000.00
19	803050	REMOVE (AND REPLACE) CHAIN LINK FENCE	LF	275	60.00	16,500.00	60.00	16,500.00
20	810230	PAVEMENT MARKER (RETROREFLECTIVE)	EA	6	40.00	240.00	10.00	60.00
21	820610	RELOCATE ROADSIGN SIGNS	EA	10	234.00	2,340.00	310.00	3,100.00
22	840519	THERMOPLASTIC CROSSWALK AND PAVEMENT MARKING	SQFT	260	7.00	1,820.00	12.10	3,146.00
23	840656	PAINT TRAFFIC STRIPE (2-COAT)	LF	1,110	2.00	2,220.00	1.80	1,998.00
24	010602	MISCELLANEOUS WORK (AS DIRECTED)	FA	1	35,000.00	35,000.00	35,000.00	35,000.00
TOTAL, ITEMS 1 - 24						737,000.00		894,000.00

**Riverside County Transportation Department
Summary of Bids**

Advertised: January 9, 2018 (Agenda Item: 3.33)

Addenda: 1 (1/25/2018), 2(2/2/2018)

Bids Open: 2 pm Date: Wednesday, February 7, 2018

PROJECT:
Mecca Area Sidewalks Project
Community of Mecca
Project No. C6-0069
State Project No. ATPL-5956(258)

6

**General Consolidated Const, Inc.
Perris, CA 92570**

BASE BID SCHEDULE									
ITEM NO.	ITEM CODE	CONTRACT ITEM	UNITS	QUANTITY	BID UNIT PRICE	BID ESTIMATE			
1	066102	DUST ABATEMENT	LS	1	24,000.00	24,000.00			
2	074020	WATER POLLUTION CONTROL	LS	1	3,700.00	3,700.00			
3	100100	DEVELOP WATER SUPPLY	LS	1	3,500.00	3,500.00			
4	120100	TRAFFIC CONTROL SYSTEM	LS	1	86,000.00	86,000.00			
5	170103	CLEARING AND GRUBBING	LS	1	45,000.00	45,000.00			
6	011503	UNDER SIDEWALK DRAIN CAST IN PLACE (CRS 309)	EA	6	3,300.00	19,800.00			
7	190101	ROADWAY EXCAVATION	CY	180	125.00	22,500.00			
8	260203	CLASS 2 AGGREGATE BASE	CY	1,880	99.00	186,120.00			
9	390130	HOT MIX ASPHALT	TON	390	180.00	70,200.00			
10	015602	FUNDING AWARENESS SIGN	EA	5	1,230.00	6,150.00			
11	017302	MINOR CONCRETE (CROSS-GUTTER) (CRS 209)	SQFT	1,000	16.00	16,000.00			
12	017303	MINOR CONCRETE (SPANDREL) (CRS 209)	SQFT	2,000	15.00	30,000.00			
13	017304	MINOR CONCRETE (CURB AND GUTTER) (CRS 200)	LF	3,500	50.00	175,000.00			
14	017310	MINOR CONCRETE (DRIVEWAY APPROACH) (CRS 207)	SQFT	6,000	8.00	48,000.00			
15	017315	MINOR CONCRETE (CURB RAMP) (CRS 403 - CASE A)	EA	3	3,800.00	11,400.00			
16	017316	MINOR CONCRETE (CURB RAMP) (CRS 403 - CASE B)	EA	4	3,000.00	12,000.00			
17	731516	MINOR CONCRETE (DRIVEWAY)	SQFT	2,035	8.00	16,280.00			
18	731521	MINOR CONCRETE (SIDEWALK)	SQFT	16,000	7.00	112,000.00			
19	803050	REMOVE (AND REPLACE) CHAIN LINK FENCE	LF	275	41.00	11,275.00			
20	810230	PAVEMENT MARKER (RETROREFLECTIVE)	EA	6	682.00	4,092.00			
21	820610	RELOCATE ROADSIGN SIGNS	EA	10	410.00	4,100.00			
22	840519	THERMOPLASTIC CROSSWALK AND PAVEMENT MARKING	SQFT	260	13.00	3,380.00			
23	840656	PAINT TRAFFIC STRIPE (2-COAT)	LF	1,110	3.00	3,330.00			
24	010602	MISCELLANEOUS WORK (AS DIRECTED)	FA	1	35,000.00	35,000.00			
TOTAL, ITEMS 1 - 24						948,827.00			



Patricia Romo, P.E.
Director of Transportation

COUNTY OF RIVERSIDE

TRANSPORTATION AND LAND MANAGEMENT AGENCY

Mojahed Salama, P.E.
Deputy for Transportation/Capital Projects
Richard Lantis, P.L.S.
Deputy for Transportation/Planning and
Development

Transportation Department

ADDENDUM NUMBER 1

Dated January 25, 2018

to the
Specifications and Contract Documents
for the construction of

Mecca Area Sidewalks Project
Community of Mecca
Project No. C6-0069
State Project No. – ATPL-5956(258)

Bids Due: (Revised)
Wednesday, February 7, 2018; 2:00 p.m.
14th Street Transportation Annex
3525 14th Street; Riverside, CA 92501
(951) 955-6780

This Addendum is issued pursuant to the Instructions to Bidders, Item No. 8, of the Contract Documents for the reference project. This Addendum is issued as a supplement to the specification and special provisions for the referenced project. The revisions to the specifications shall become a part of the Contract Documents, and each bidder shall acknowledge receipt thereof on the Bid (Proposal). Bidders are directed to sign this addendum as acknowledged, and attach the signed addendum to the contractor's submitted proposal.

Note: During the advertisement period of this project, this document and attachments (if any) are available upon request at the office of the Transportation Department, and are available as a free download at the Transportation Department's website:

<http://rctlma.org/trans/Contractors-Corner/Notices-Inviting-Bids>

MODIFICATIONS / CLARIFICATIONS TO SPECIAL PROVISIONS:

Item 1: The new designated date and time for the receipt and opening of bids is revised as follows:

Wednesday, February 7, 2018; 2:00 p.m.
14th Street Transportation Annex
3525 14th Street; Riverside, CA 92501
(951) 955-6780

Prepared by: _____

Joel Jimenez, PE; Senior Civil Engineer, Contracts/Bidding Unit

1/25/18

Acknowledged: _____

Date: _____

(Contractor)

JRJ:sb



Patricia Romo, P.E.
Director of Transportation

COUNTY OF RIVERSIDE

TRANSPORTATION AND LAND MANAGEMENT AGENCY

Mojahed Salama, P.E.
Deputy for Transportation/Capital Projects
Richard Lantis, P.L.S.
Deputy for Transportation/Planning and
Development

Transportation Department

ADDENDUM NUMBER 2

Dated February 2, 2018

to the
Specifications and Contract Documents
for the construction of

Mecca Area Sidewalks Project
Community of Mecca
Project No. C6-0069
State project No. ATPL-5956(258)

Bids Due: Wednesday, February 7, 2018; 2:00 p.m.
14th Street Transportation Annex
3525 14th Street; Riverside, CA 92501
(951) 955-6780

This Addendum is issued pursuant to the Instructions to Bidders, Item No. 8, of the Contract Documents for the reference project. This Addendum is issued as a supplement to the specification and special provisions for the referenced project. The revisions to the specifications shall become a part of the Contract Documents, and each bidder shall acknowledge receipt thereof on the Bid (Proposal). Bidders are directed to sign this addendum as acknowledged, and attach the signed addendum to the contractor's submitted proposal.

Note: During the advertisement period of this project, this document and attachments (if any) are available upon request at the office of the Transportation Department, and are available as a free download at the Transportation Department's website:

<http://rctlma.org/trans/Contractors-Corner/Notices-Inviting-Bids>

MODIFICATIONS / CLARIFICATIONS TO SPECIAL PROVISIONS:

Item 1: Revised Proposal

Refer to "Proposal" page B2. Delete and replace "Proposal" (page B2) with "Proposal (Revised)" attached herewith as **Attachment "A"**.

a. The quantities of following bid items has been revised in the bid proposal.

Item# 7; ROADWAY EXCAVATION
Item# 8; CLASS 2 AGGREGATE BASE
Item# 9; HOT MIX ASPHALT

MODIFICATIONS / CLARIFICATIONS TO THE PLANS

Item 2: Plan sheet Replacement.

Remove and replace plan sheets 2 through 5 with revised plan sheets 2 through 5 issued by this addendum as **Attachment B**.

Note: The revised plan sheet 2 -5 are posted on the County website and is available for download during the advertisement period.

<http://rctlma.org/trans/Contractors-Corner/Notices-Inviting-Bids>

This addendum has been prepared under the direction of the following registered Civil Engineer(s):

Recommended by:

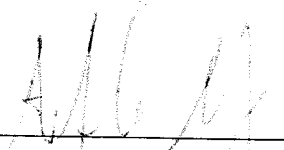
_____ 2/2/18

Alfredo Martinez, PE
County Project Manager

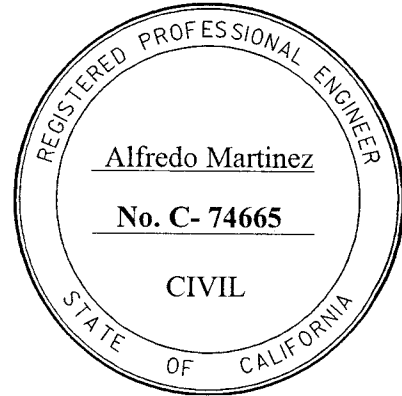

Concurrence:

_____ 2/2/18

Khalid Nasim, PE
Engineering Division Manager

Acknowledged: _____ **Date:** _____
(Contractor)

JRJ:jrj:sb

Note: Refer to Instruction to Bidders Item No. 8, "Addenda". Submission of all addendum pages and non-bidding document attachments of addendum are not necessary for Bid submittal. Submittal of this acknowledgement page is adequate for Bid reception. Bidders are reminded to list addendum number(s) received on the first page of the Bid form (Proposal).

ATTACHMENTS

A – Revised Proposal

B – Revised Plan Sheets (2-5)

**Mecca Area Sidewalks Project
Community of Mecca
Project No. C6-0069
State Project No. ATPL-5956(258)**

PROPOSAL (REVISED)

ITEM No.	ITEM CODE	ITEM	UNIT	ESTIMATED QUANTITY	ITEM PRICE (IN FIGURES)	TOTAL (IN FIGURES)
1	066102	DUST ABATEMENT	LS	1		
2	074020	WATER POLLUTION CONTROL	LS	1		
3	100100	DEVELOP WATER SUPPLY	LS	1		
4	120100	TRAFFIC CONTROL SYSTEM	LS	1		
5	170103	CLEARING AND GRUBBING	LS	1		
6	011503	UNDER SIDEWALK DRAIN CAST IN PLACE (CRS 309)	EA	6		
7	190101	ROADWAY EXCAVATION	CY	180		
8	260203	CLASS 2 AGGREGATE BASE	CY	1,880		
9	390130	HOT MIX ASPHALT	TON	390		
10	015602	FUNDING AWARENESS SIGN	EA	5		
11	017302	MINOR CONCRETE (CROSS-GUTTER) (CRS 209)	SQFT	1,000		
12	017303	MINOR CONCRETE (SPANDREL) (CRS 209)	SQFT	2,000		
13	017304	MINOR CONCRETE (CURB AND GUTTER) (CRS 200)	LF	3,500		
14	017310	MINOR CONCRETE (DRIVEWAY APPROACH) (CRS 207)	SQFT	6,000		
15	017315	MINOR CONCRETE (CURB RAMP) (CRS 403 - CASE A)	EA	3		
16	017316	MINOR CONCRETE (CURB RAMP) (CRS 403 - CASE B)	EA	4		
17	731516	MINOR CONCRETE (DRIVEWAY)	SQFT	2,035		
18	731521	MINOR CONCRETE (SIDEWALK)	SQFT	16,000		
19	803050	REMOVE (AND REPLACE) CHAIN LINK FENCE	LF	275		
20	810230	PAVEMENT MARKER (RETROREFLECTIVE)	EA	6		
21	820610	RELOCATE ROADSIGN SIGNS	EA	10		
22	840519	THERMOPLASTIC CROSSWALK AND PAVEMENT MARKING	SQFT	260		
23	840656	PAINT TRAFFIC STRIPE (2-COAT)	LF	1,110		
24	010602	MISCELLANEOUS WORK (AS DIRECTED)	FA	1	35,000.00	35,000.00

PROJECT
TOTAL:
ITEMS 1-24

"WORDS"

\$

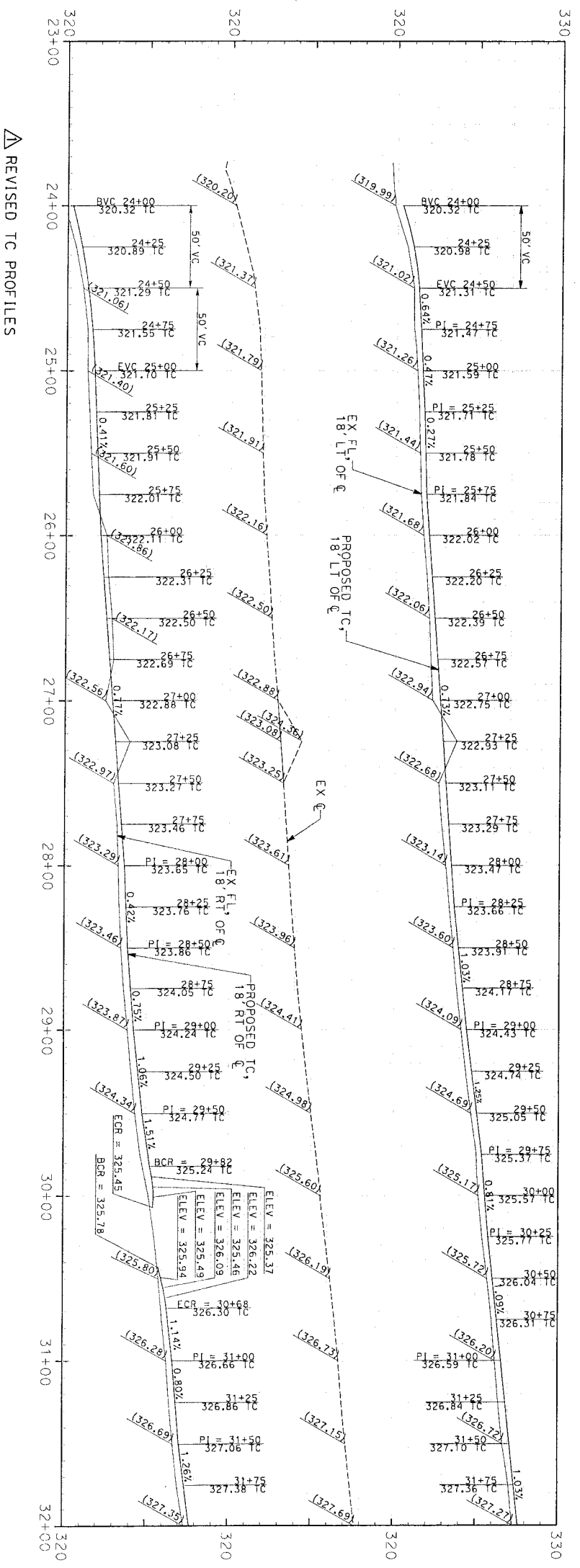

CONSTRUCTION NOTES:

- 1 PROTECT
- 2 MATCH EXISTING
- 3 SAWCUT
- 4 ADJUST EXISTING WATER METER TO GRADE BY CWDV FORCES
- 5 CONSTRUCT UNDER SIDEWALK DRAIN PER STD NO. 309
- 6 REMOVE ASPHALT CONCRETE AND AGGREGATE BASE TO A DEPTH OF 1.50'; MOISTURE CONDITION UNDERLYING BASE MATERIAL AND RECOMPACT TO 95%
- 7 REMOVE AND REPLACE SIDEWALK PANEL
- 8 RECONSTRUCT EXISTING CONCRETE CROSS GUTTER PER STD NO. 209
- 9 REMOVE TREE(S)
- 10 SALVAGE EXISTING SIGN AND INSTALL NEW SIGN PER STD NO. 1222
- 11 REMOVE AND REPLACE CHAIN LINK FENCE TO RIGHT OF WAY
- 12 REMOVE AND REPLACE CURB RAMP, CASE A, PER STD NO. 403 (8' TIE-INS)
- 13 REMOVE AND REPLACE EXISTING THEMOPLASTIC PAVEMENT MARKINGS PER CALTRANS STD DETAIL A240 - A24E
- 14 RELOCATE EXISTING BLOWOFF VALVE BY CWDV FORCES
- 15 RELOCATE POWER POLE / LIGHT POLE BY IID
- 16 CONSTRUCT TYPE A-6 CURB AND GUTTER PER STD NO. 200
- 17 CONSTRUCT 10' CURB AND GUTTER TRANSITION, A-6 TO A-8
- 18 CONSTRUCT SIDEWALK PER STD NO. 401
- 19 CONSTRUCT CURB RAMP, CASE A, PER STD NO. 403
- 20 CONSTRUCT CURB RAMP, CASE B, PER STD NO. 403
- 21 CONSTRUCT GROSS CUTTER AND SPANDREL PER STD NO. 209
- 22 NOT USED
- 23 CONSTRUCT DRIVEWAY APPROACH PER STD NO. 207
- 24 PLACE 0.50' OF HMA TYPE "A" PG64-10.74" OVER 1.00' OF AGGREGATE BASE
- 25 CONSTRUCT PCC DRIVEWAY TIE-IN
- 26 CONSTRUCT CURB AND GUTTER TRANSITION IN SIDEWALK WING, A-8 TO A-6
- 27 RELOCATE FIRE HYDRANT BY CWDV FORCES
- 28 RELOCATE TRANSFORMER BY IID
- 29 CONTRACTOR TO COORDINATE WITH CWDV (CWDV TO ABANDON)
- 30 REPLACE WATER METER BOX BY CWDV
- 31 REPAIR ASPHALT CONCRETE

△ REVISED TC PROFILES

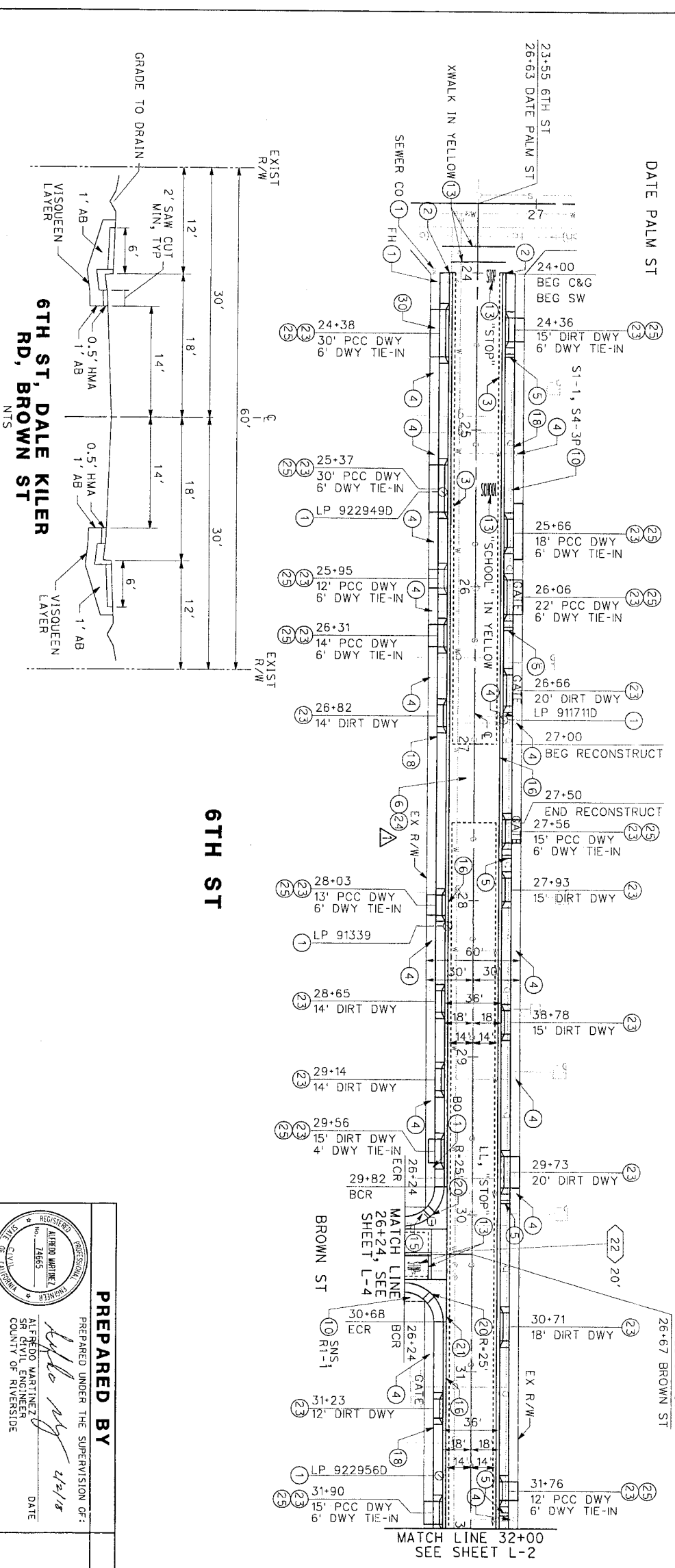

6TH ST

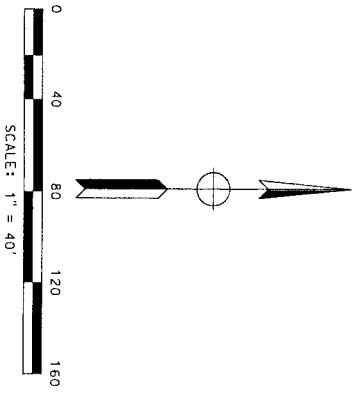

PREPARED BY

PREPARED UNDER THE SUPERVISION OF:
 ALFREDO MARTINEZ
 SR CIVIL ENGINEER
 COUNTY OF RIVERSIDE
 DATE: 2/2/18

LAYOUT SHEET NO.

6TH STREET SIDEWALK
 24+00 TO 32+00
L-1
 SHEET 2 OF 5

CONSTRUCTION NOTES:

- ① PROTECT
- ② MATCH EXISTING
- ③ SAWCUT
- ④ ADJUST EXISTING WATER METER TO GRADE BY CVWD FORCES
- ⑤ CONSTRUCT UNDER SIDEWALK DRAIN PER STD No. 309
- ⑩ SALVAGE EXISTING SIGN AND INSTALL NEW SIGN PER STD No. 1222
- ⑪ REMOVE AND REPLACE CHAIN LINK FENCE TO RIGHT OF WAY
- ⑫ REMOVE AND REPLACE CURB RAMP, CASE A, PER STD No. 403 (8" TIE-INS)
- ⑬ REMOVE AND REPLACE EXISTING THERMOPLASTIC PAVEMENT MARKINGS PER CALTRANS STD DETAIL A240 - A24E
- ⑯ CONSTRUCT TYPE A-6 CURB AND GUTTER PER STD No. 200
- ⑰ CONSTRUCT 10' CURB AND GUTTER TRANSITION, A-6 TO A-8
- ⑱ CONSTRUCT SIDEWALK PER STD No. 401
- ⑲ CONSTRUCT CURB RAMP, CASE B, PER STD No. 403
- ⑳ CONSTRUCT CROSS CUTTER AND SPANDREL PER STD No. 209
- ㉑ CONSTRUCT DRIVEWAY APPROACH PER STD No. 207
- ㉒ CONSTRUCT PCC DRIVEWAY TIE-IN
- ㉓ CONTRACTOR TO COORDINATE WITH CVWD (CVWD TO ABANDON)
- ⓧ PAINT PAVEMENT MARKERS AND TRAFFIC LINES PER CALTRANS STDS A20A - A20D

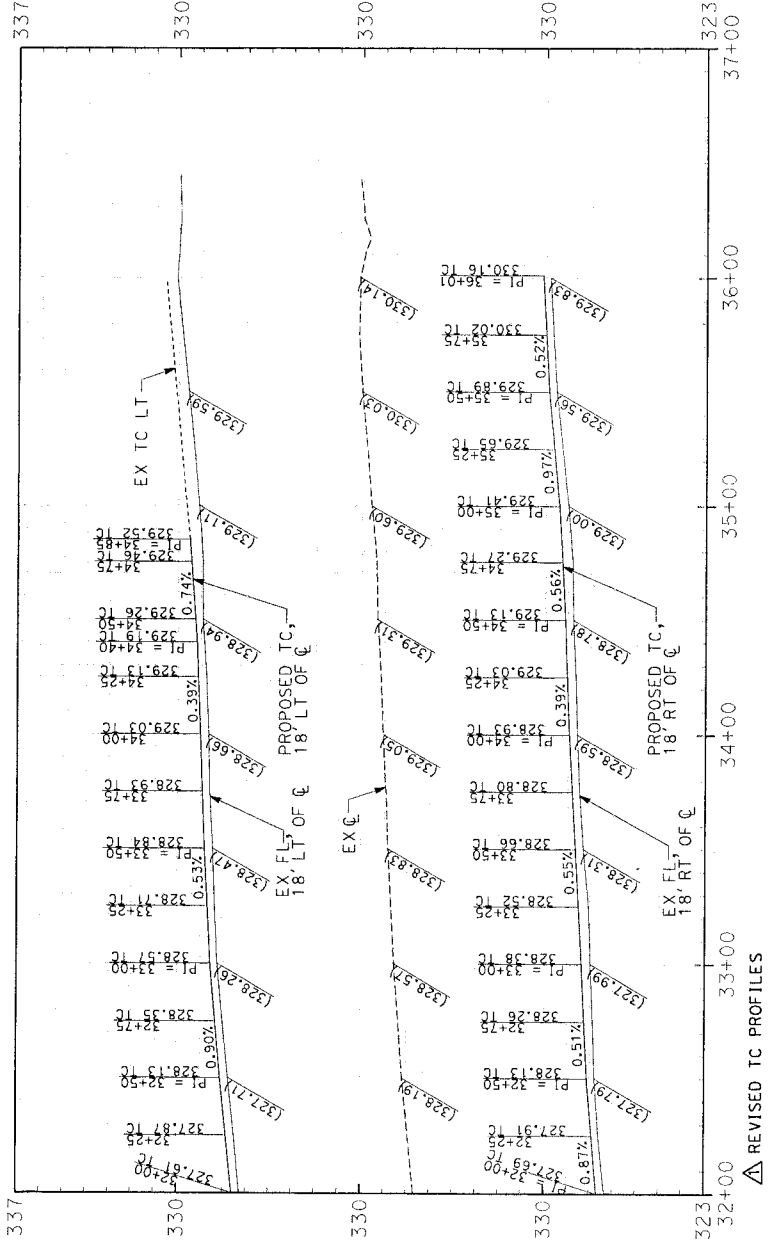

△ REVISED TC PROFILES

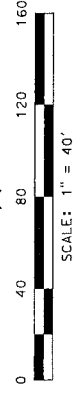
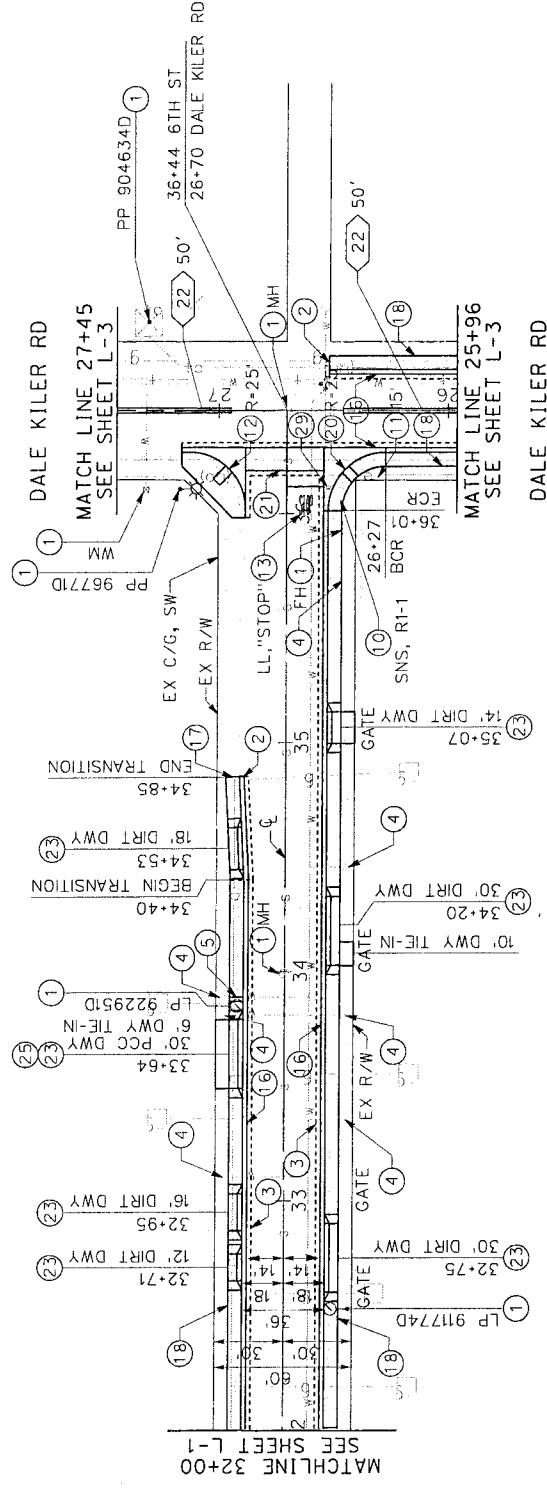

6TH ST

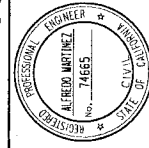
PREPARED BY	LAYOUT	SHEET No.
PREPARED UNDER THE SUPERVISION OF:  Alfredo Martinez SR CIVIL ENGINEER COUNTY OF RIVERSIDE DATE: 2/21/15	6TH STREET SIDEWALK	L-2
	32+00 TO 36+44	SHEET 3 OF 5

Bid

Date: 02/07/2018

To: County of Riverside, hereafter called "County";

Bidder: CT&t Concrete Paving, Inc.
(hereafter called "Contractor")

The undersigned, Contractor, having carefully examined the site and the Contract Documents for the construction of **Mecca Area Sidewalks Project, Community of Mecca, Project No. C6-0069, State Project No. ATPL-5956(258)** hereby proposes to construct the work in accordance with the Contract Documents, including **Addenda Number(s)** 1-2 (Fill in addenda numbers if addenda have been issued.) for the amount stated in this Bid.

By submitting this Bid, Contractor agrees with County:

1. That unless withdrawn in person by Contractor or some person authorized in writing by Contractor (not by telephone or facsimile) before the time specified in the Notice Inviting Bids for the public opening of bids, this Bid constitutes an irrevocable offer for 90 calendar days after that date.
2. County has the right to reject any or all Bids and to waive any irregularities or informalities contained in a Bid.
3. To execute the Contract and deliver the Performance Bond, Payment Bond and Insurance Certificate with endorsements, that comply with the requirements set forth in the Instruction to Bidders and General Conditions within ten (10) business days of the date of the Notice of Acceptance of Bid and Intent to Award as issued by the County.
4. That the contract shall be awarded upon a resolution or minute order to that effect duly adopted by the governing body of County; and that execution of the Contract shall constitute a written memorial thereof.
5. To submit to the County such information as County may require determining whether a particular Bid is the lowest responsible bid submitted.
6. That the accompanying Bid Bond, certified check or cashier's check is in an amount not less than 10% of the total bid submitted and constitutes a guarantee that if awarded the contract, Contractor will execute the Contract and deliver the required bonds within ten (10) business days after notice of award. If Contractor fails to execute and deliver said documents, the bond or check is to be charged with the costs of the resultant damages to the County, including but not limited to: publication costs, the difference in money between the amount bid and the amount in excess of the bid which it costs County to do or cause to be done for the work involved, lease and rental costs, additional salaries and overhead, increased interest and costs of funding the project, attorney expense, additional engineering and architectural expense and cost of maintaining or constructing alternate facilities occasioned by the failure to execute and deliver said documents.
7. By signing this Bid the Contractor certifies that the representations made therein are made under penalty of perjury.

**Mecca Area Sidewalks Project
Community of Mecca
Project No. C6-0069
State Project No. ATPL-5956(258)**

PROPOSAL (REVISED)

ITEM No.	ITEM CODE	ITEM	UNIT	ESTIMATED QUANTITY	ITEM PRICE (IN FIGURES)	TOTAL (IN FIGURES)
1	066102	DUST ABATEMENT	LS	1	5,000.00	5,000.00
2	074020	WATER POLLUTION CONTROL	LS	1	2,000.00	2,000.00
3	100100	DEVELOP WATER SUPPLY	LS	1	4,500.00	4,500.00
4	120100	TRAFFIC CONTROL SYSTEM	LS	1	6,000.00	6,000.00
5	170103	CLEARING AND GRUBBING	LS	1	8,000.00	8,000.00
6	011503	UNDER SIDEWALK DRAIN CAST IN PLACE (CRS 309)	EA	6	200.00	1,200.00
7	190101	ROADWAY EXCAVATION	CY	180	79.00	14,220.00
8	260203	CLASS 2 AGGREGATE BASE	CY	1,880	25.00	47,000.00
9	390130	HOT MIX ASPHALT	TON	390	112.00	43,680.00
10	015602	FUNDING AWARENESS SIGN	EA	5	750.00	3,750.00
11	017302	MINOR CONCRETE (CROSS-GUTTER) (CRS 209)	SQFT	1,000	12.00	12,000.00
12	017303	MINOR CONCRETE (SPANDREL) (CRS 209)	SQFT	2,000	14.00	28,000.00
13	017304	MINOR CONCRETE (CURB AND GUTTER) (CRS 200)	LF	3,500	40.00	140,000.00
14	017310	MINOR CONCRETE (DRIVEWAY APPROACH) (CRS 207)	SQFT	6,000	7.00	42,000.00
15	017315	MINOR CONCRETE (CURB RAMP) (CRS 403 - CASE A)	EA	3	3,000.00	9,000.00
16	017316	MINOR CONCRETE (CURB RAMP) (CRS 403 - CASE B)	EA	4	3,400.00	13,600.00
17	731516	MINOR CONCRETE (DRIVEWAY)	SQFT	2,035	7.00	14,245.00
18	731521	MINOR CONCRETE (SIDEWALK)	SQFT	16,000	5.65	90,400.00
19	803050	REMOVE (AND REPLACE) CHAIN LINK FENCE	LF	275	40.00	11,000.00
20	810230	PAVEMENT MARKER (RETROREFLECTIVE)	EA	6	99.00	594.00
21	820610	RELOCATE ROADSIGN SIGNS	EA	10	242.00	2,420.00
22	840519	THERMOPLASTIC CROSSWALK AND PAVEMENT MARKING	SQFT	260	6.60	1,716.00
23	840656	PAINT TRAFFIC STRIPE (2-COAT)	LF	1,110	1.10	1,221.00
24	010602	MISCELLANEOUS WORK (AS DIRECTED)	FA	1	35,000.00	35,000.00

PROJECT TOTAL: Five Hundred Thirty Six Thousand Five Hundred Forty Six Dollars \$ 536,546.00
ITEMS 1-24 "WORDS"

Bidder Data and Signature

Name of Bidder: CT&T Concrete Paving, Inc.

Type of organization: Corporation

Person(s) authorized to sign for Bidder: 

Jose Carvajal , President , Vice President, Secretary , Manager

Jacqueline Carvajal , Treasurer

Note:

If Bidder is a **Corporation**, state legal name of Corporation and also names of the president, vice-president, secretary, treasurer and manager thereof.

If Bidder is a **Co-Partnership**, state true name of firm and also names of all individual co-partners composing firm.

If Bidder is a sole proprietorship or an **Individual**, state first and last name(s) in full.

If Bid is signed by an agent other than an owner, partner or corporate officer, Bid shall be accompanied by a power-of-attorney.

Business Street Address: 324 S Diamond Bar Blvd
(Please include business address even if P.O. Box is used.)

Business City, State, Zip Code: Diamond Bar , CA 91765

P.O. Box- Number: PMB 275

P.O. Box- City, State, Zip Code: Diamond Bar , CA 91765

Phone: (909) 629-8000

Facsimile: (909) 629 -8001

E-mail: jose.cttinc@gmail.com

Contractor's license number: 875627

License Classification(s): C8, C12

Expiration date: 04/05/2018

Department of Industrial Relations Registration Number: 1000025154

Bidder Data and Signature (continued)

Accompanying this Bid is a certified check, cashier check or bid bond in an amount equal to at least ten (10) percent of the total bid for:

Mecca Area Sidewalks Project

Community of Mecca

Project No. C6-0069

State Project No. ATPL-5956(258)

By my signature on this Bid, I certify, under penalty of perjury under the laws of the State of California, that all the information on this form is true and correct.

IN WITNESS WHERE OF Bidder/Contractor executed this Bid as of the date set forth on page B1 of this Bid.

Signature:

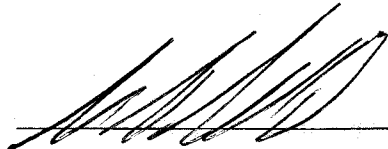

Name (printed):

Jose Carvajal

Title:

President

“Contractor”

Subcontractor List

Bidder/Contractor submits the following complete list of each Subcontractor who will perform work, labor or render service in or about the construction in an amount in excess of 1/2 of 1% of the total bid or \$10,000 whichever is greater.

Check box on right side of row if any construction item, for the listed Subcontractor, is partial work. If partial work is to be performed within a certain construction item or trade, the Bidder/Contractor shall specify the portion(s) of the work to be performed by the different subcontractors or Bidder/Contractor will be subject to provisions of Public Contract Code Section 4106.

Name of Bidder (Prime/General Contractor): CT&T Concrete Paving, Inc.

	Subcontractor Name	License Number	DIR Registration Number	Business Address (City, State)	Construction Item(s) [Item Number and Description]	Check if Partial Work
1.	PCI	823802	1000005687	975 W 1st Street Azusa , CA	20-23	<input checked="" type="checkbox"/>
2.						<input type="checkbox"/>
3.						<input type="checkbox"/>
4.						<input type="checkbox"/>
5.						<input type="checkbox"/>
6.						<input type="checkbox"/>

Additional Subcontractor List(s) may be attached to the Bid.
(A copy of this form may be attached with additional Subcontractor information.)

Percent of work to be performed by Subcontractors: _____%

Note: A minimum of 50% of the work is required to be performed by the prime/general Contractor.

Non-Collusion Declaration

To be executed by bidder and submitted with bid.
(Title 23 United States Code Section 112 and Public Contract Code Section 7106)

The undersigned declares: Jose Carvajal

I am the President (Title) of CT&T Concrete Paving, Inc. (Company),
the party making the foregoing bid.

The bid is not made in the interest of, or on behalf of, any undisclosed person, partnership, company, association, organization, or corporation. The bid is genuine and not collusive or sham. The bidder has not directly or indirectly induced or solicited any other bidder to put in a false or sham bid. The bidder has not directly or indirectly colluded, conspired, connived, or agreed with any bidder or anyone else to put in a sham bid, or that anyone shall refrain from bidding. The bidder has not in any manner, directly or indirectly, sought by agreement, communication, or conference with anyone to fix the bid price of the bidder or any other bidder, or to fix any overhead, profit, or cost element of the bid price, or of that of any other bidder.

All statements contained in the bid are true. The bidder has not, directly or indirectly, submitted his or her bid price of any breakdown thereof, or the contents thereof, or divulged information or data relative thereto, to any corporation, partnership, company, association, organization, bid depository, or to any member or agent thereof to effectuate a collusive or sham bid, and has not paid, and will not pay, any person or entity for such purpose.

Any person executing this declaration on behalf of a bidder that is a corporation, partnership, joint venture, limited liability company, limited liability partnership, or any other entity, hereby represents that he or she has full power to execute, and does execute, this declaration on behalf of the bidder.

I declare under penalty of perjury under the applicable laws that the foregoing is true and correct and that this declaration is executed on

February (Month) 07 (Day) of 2018 (Year),
at Pomomna (City), CA (State).

Signature of Declarant:

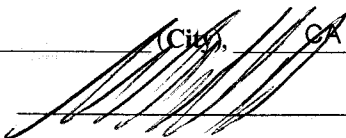

Printed name of Declarant: Jose Carvajal

Name of Bidder (Company): CT&T Concrete Paving, Inc.

Title or Office: President

Note: Notarization of signature required.
 Check box if attachment is included.

ALL-PURPOSE CERTIFICATE OF ACKNOWLEDGMENT

A notary public or other officer completing this certificate verifies only the identity of the individual who signed the document to which this certificate is attached, and not the truthfulness, accuracy, or validity of that document.

State of California)

County of Los Angeles)

On February 1st, 2018 before me, Amy Elise Moody, Notary Public,
(Here insert name and title of the officer)

personally appeared, Jose Guadalupe Carvajal,
 who proved to me on the basis of satisfactory evidence to be the person(s) whose name(s) ~~is~~ are subscribed to the within instrument and acknowledged to me that ~~he~~ she/they executed the same in ~~his~~ her/their authorized capacity(ies), and that by ~~his~~ her/their signature(s) on the instrument the person(s), or the entity upon behalf of which the person(s) acted, executed the instrument.

I certify under PENALTY OF PERJURY under the laws of the State of California that the foregoing paragraph is true and correct.

WITNESS my hand and official seal.

Amy E. Moody
 Signature _____ (Seal)

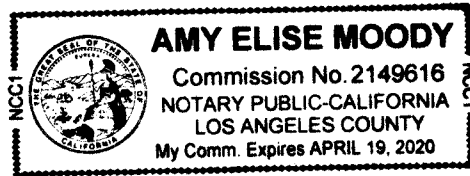

ADDITIONAL OPTIONAL INFORMATION

DESCRIPTION OF THE ATTACHED DOCUMENT
NDN COLLISION
(Title or description of attached document)

(Title or description of attached document continued)

Number of Pages _____ Document Date _____

CAPACITY CLAIMED BY THE SIGNER

Individual (s)

Corporate Officer
President
(Title)

Partner(s)

Attorney-in-Fact

Trustee(s)

Other _____

INSTRUCTIONS FOR COMPLETING THIS FORM

This form complies with current California statutes regarding notary wording and, if needed, should be completed and attached to the document. Acknowledgments from other states may be completed for documents being sent to that state so long as the wording does not require the California notary to violate California notary law.

- State and County information must be the State and County where the document signer(s) personally appeared before the notary public for acknowledgment.
- Date of notarization must be the date that the signer(s) personally appeared which must also be the same date the acknowledgment is completed.
- The notary public must print his or her name as it appears within his or her commission followed by a comma and then your title (notary public).
- Print the name(s) of document signer(s) who personally appear at the time of notarization.
- Indicate the correct singular or plural forms by crossing off incorrect forms (i.e. ~~he~~/she/~~they~~, is /are) or circling the correct forms. Failure to correctly indicate this information may lead to rejection of document recording.
- The notary seal impression must be clear and photographically reproducible. Impression must not cover text or lines. If seal impression smudges, re-seal if a sufficient area permits, otherwise complete a different acknowledgment form.
- Signature of the notary public must match the signature on file with the office of the county clerk.
 - ❖ Additional information is not required but could help to ensure this acknowledgment is not misused or attached to a different document.
 - ❖ Indicate title or type of attached document, number of pages and date.
 - ❖ Indicate the capacity claimed by the signer. If the claimed capacity is a corporate officer, indicate the title (i.e. CEO, CFO, Secretary).
- Securely attach this document to the signed document with a staple.

Iran Contracting Act
(Public Contract Code sections 2200-2208)

Prior to bidding on, submitting a proposal or executing a contract or renewal for a County of Riverside contract for goods or services of **\$1,000,000 or more**, a Contractor must either:

- a) Certify it is not on the current list of persons engaged in investment activities in Iran created by the California Department of General Services ("DGS") pursuant to Public Contract Code section 2203(b) and is not a financial institution extending twenty million dollars (\$20,000,000) or more in credit to another person, for 45 days or more, if that other person will use the credit to provide goods or services in the energy sector in Iran and is identified on the current list of persons engaged in investment activities in Iran created by DGS; or
- b) Demonstrate it has been exempted from the certification requirement for that solicitation or contract pursuant to Public Contract Code section 2203(c) or (d).

To comply with this requirement, please insert your Contractor or financial institution name and Federal ID Number (if available) and complete one of the options below. Please note: California law establishes penalties for providing false certifications, including civil penalties equal to the greater of \$250,000 or twice the amount of the contract for which the false certification was made; contract termination; and three-year ineligibility to bid on contracts. (Public Contract Code section 2205.)

Option #1 – Certification

I, the official named below, certify I am duly authorized to execute this certification on behalf of the vendor/financial institution identified below, and the vendor/financial institution identified below is **not** on the current list of persons engaged in investment activities in Iran created by DGS and is not a financial institution extending twenty million dollars (\$20,000,000) or more in credit to another person/vendor, for 45 days or more, if that other person/vendor will use the credit to provide goods or services in the energy sector in Iran and is identified on the current list of persons engaged in investment activities in Iran created by DGS.

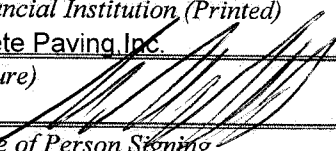
<i>Contractor Name/Financial Institution (Printed)</i> CT&T Concrete Paving, Inc.		<i>Federal ID Number (or n/a)</i> 20-2642225
<i>By (Authorized Signature)</i> 		
<i>Printed Name and Title of Person Signing</i> Jose Carvajal, President		
<i>Date Executed</i> 02/07/2018	<i>Executed in</i> Pomona, CA	

Option #2 – Exemption

Pursuant to Public Contract Code sections 2203(c) and (d), a public entity may permit a Contractor/financial institution engaged in investment activities in Iran, on a case-by-case basis, to be eligible for, or to bid on, submit a proposal for, or enters into or renews, a contract for goods and services.

If you have obtained an exemption from the certification requirement under the Iran Contracting Act, please fill out the information below, and **attach documentation demonstrating the exemption approval.**

<i>Contractor Name/Financial Institution (Printed)</i>		<i>Federal ID Number (or n/a)</i>
<i>By (Authorized Signature)</i>		
<i>Printed Name and Title of Person Signing</i>		
<i>Date Executed</i>	<i>Executed in</i>	

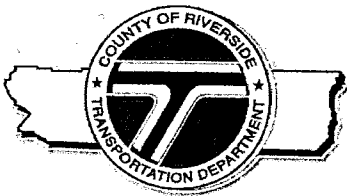

Patricia Romo, P.E.
Director of Transportation

COUNTY OF RIVERSIDE TRANSPORTATION AND LAND MANAGEMENT AGENCY

Mojahed Salama, P.E.
Deputy for Transportation/Capital Projects
Richard Lantis, P.L.S.
Deputy for Transportation/Planning and
Development

Transportation Department

ADDENDUM NUMBER 1

Dated January 25, 2018

to the
Specifications and Contract Documents
for the construction of

Mecca Area Sidewalks Project
Community of Mecca
Project No. C6-0069
State Project No. – ATPL-5956(258)

Bids Due: (Revised)
Wednesday, February 7, 2018; 2:00 p.m.
14th Street Transportation Annex
3525 14th Street; Riverside, CA 92501
(951) 955-6780

This Addendum is issued pursuant to the Instructions to Bidders, Item No. 8, of the Contract Documents for the reference project. This Addendum is issued as a supplement to the specification and special provisions for the referenced project. The revisions to the specifications shall become a part of the Contract Documents, and each bidder shall acknowledge receipt thereof on the Bid (Proposal). Bidders are directed to sign this addendum as acknowledged, and attach the signed addendum to the contractor's submitted proposal.

Note: During the advertisement period of this project, this document and attachments (if any) are available upon request at the office of the Transportation Department, and are available as a free download at the Transportation Department's website:

<http://rctlma.org/trans/Contractors-Corner/Notices-Inviting-Bids>

MODIFICATIONS / CLARIFICATIONS TO SPECIAL PROVISIONS:

Item 1: The new designated date and time for the receipt and opening of bids is revised as follows:

Wednesday, February 7, 2018; 2:00 p.m.
14th Street Transportation Annex
3525 14th Street; Riverside, CA 92501
(951) 955-6780

Prepared by:  1/25/18
Joel Jimenez, PE; Senior Civil Engineer, Contracts/Bidding Unit

Acknowledged:  Date: 2-07-18
(Contractor)

JRJ:sb



Patricia Romo, P.E.
Director of Transportation

COUNTY OF RIVERSIDE

TRANSPORTATION AND LAND MANAGEMENT AGENCY

Mojahed Salama, P.E.
Deputy for Transportation/Capital Projects
Richard Lantis, P.L.S.
Deputy for Transportation/Planning and
Development

Transportation Department

ADDENDUM NUMBER 2

Dated February 2, 2018

to the
Specifications and Contract Documents
for the construction of

Mecca Area Sidewalks Project
Community of Mecca
Project No. C6-0069
State project No. ATPL-5956(258)

Bids Due: Wednesday, February 7, 2018; 2:00 p.m.
14th Street Transportation Annex
3525 14th Street, Riverside, CA 92501
(951) 955-6780

This Addendum is issued pursuant to the Instructions to Bidders, Item No. 8, of the Contract Documents for the reference project. This Addendum is issued as a supplement to the specification and special provisions for the referenced project. The revisions to the specifications shall become a part of the Contract Documents, and each bidder shall acknowledge receipt thereof on the Bid (Proposal). Bidders are directed to sign this addendum as acknowledged, and attach the signed addendum to the contractor's submitted proposal.

Note: During the advertisement period of this project, this document and attachments (if any) are available upon request at the office of the Transportation Department, and are available as a free download at the Transportation Department's website:

<http://rctlma.org/trans/Contractors-Corner/Notices-Inviting-Bids>

MODIFICATIONS / CLARIFICATIONS TO SPECIAL PROVISIONS:

Item 1: Revised Proposal

Refer to "Proposal" page B2. Delete and replace "Proposal" (page B2) with "Proposal (Revised)" attached herewith as Attachment "A".

- a. The quantities of following bid items has been revised in the bid proposal.

Item# 7; ROADWAY EXCAVATION
Item# 8; CLASS 2 AGGREGATE BASE
Item# 9; HOT MIX ASPHALT

MODIFICATIONS / CLARIFICATIONS TO THE PLANS

Item 2: Plan sheet Replacement.

Remove and replace plan sheets 2 through 5 with revised plan sheets 2 through 5 issued by this addendum as **Attachment B**.

Note: The revised plan sheet 2 -5 are posted on the County website and is available for download during the advertisement period.

<http://rctlma.org/trans/Contractors-Corner/Notices-Inviting-Bids>

This addendum has been prepared under the direction of the following registered Civil Engineer(s):

Recommended by:

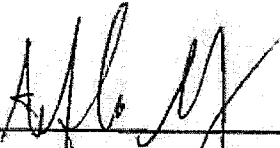

Alfredo Martinez, PE
County Project Manager

2/2/18

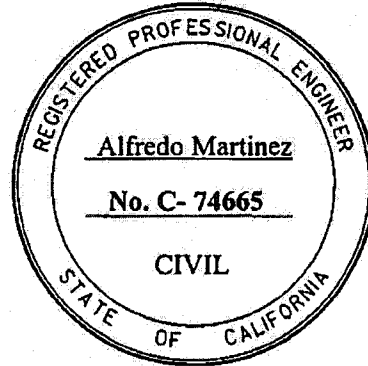

Concurrence:

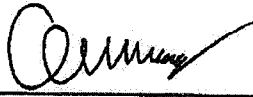

Khalid Nasim, PE
Engineering Division Manager

2/2/18

Acknowledged:

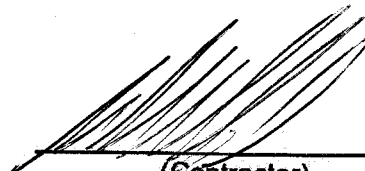

(Contractor)

Date: 02/07/2018

JRJ:jrj:sb

Note: Refer to Instruction to Bidders Item No. 8, "Addenda". Submission of all addendum pages and non-bidding document attachments of addendum are not necessary for Bid submittal. Submittal of this acknowledgement page is adequate for Bid reception. Bidders are reminded to list addendum number(s) received on the first page of the Bid form (Proposal).

ATTACHMENTS

A – Revised Proposal

B – Revised Plan Sheets (2-5)

Bid Bond

Recitals:

1. CT&T Concrete Paving, Inc. "Contractor", has submitted his/her Contractor's Proposal to County of Riverside, "County", for the construction of public work for Mecca Area Sidewalks Project, Community of Mecca, Project No. C6-0069, State Project No. ATPL-5956(258) in accordance with a Notice Inviting Bids from the County.
2. Contractors Bonding and Insurance Company a Illinois corporation, hereafter called "Surety", is the surety of this bond.

Agreement:

We, Contractor as Principal and Surety as Surety, jointly and severally agree and state as follows:

1. The amount of the obligation of this bond is 10% of the amount of the Contractor's Proposal, including bid alternates, and inures to the benefit of County.
2. This Bond is exonerated by (1) County rejecting said Proposal or, in the alternate, (2) if said Proposal is accepted, Contractor executes the Contract and furnishes the Bonds as agreed to in its Proposal, otherwise it remains in full force and effect for the recovery of loss, damage and expense of County resulting from failure of Contractor to act as agreed to in its Proposal. Some types of possible loss, damage and expense are specified in the Contractor's Proposal.
3. Surety, for value received, stipulates and agrees that its obligations hereunder shall in no way be impaired or affected by any extension of time within which County may accept the Proposal and waives notice of any such extension.
4. This Bond is binding on our heirs, executors, administrators, successors and assigns.

Dated: February 7, 2018
Signatures:

<u>Contractors Bonding and Insurance Company</u>	<u>CT&T Concrete Paving, Inc.</u>
By: <u>[Signature]</u>	By: <u>[Signature]</u>
Title: <u>Yung T. Mullick</u> <u>Attorney in Fact</u> <u>"Surety"</u>	Title: <u>"Contractor"</u>

STATE OF See Attached
COUNTY California } ss. SURETY'S ACKNOWLEDGEMENT
OF California

On Los Angeles before me, Amy Elise Moody, Notary Public
personally appeared, February 7th 2018 known to me, or proved to me on the basis
of satisfactory evidence, to be the person whose name is subscribed to the within instrument and
acknowledged to me that he/she executed the same in his/her authorized capacities, and that by his/her
signature on the instrument the person, or the entity upon behalf of which the person acted, executed the
instrument.

WITNESS my hand and official seal.
Amy E. Moody
Signature of Notary Public

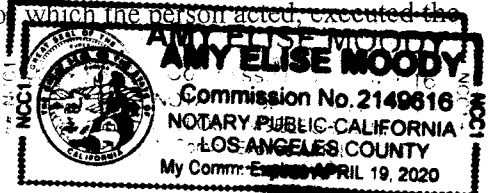

Notary Public (Seal)

Note: This Bond must be executed by both Contractor and Surety with corporate seal affixed. All signatures must be notarized. (Attach acknowledgements).

CALIFORNIA ALL-PURPOSE ACKNOWLEDGMENT

A notary public or other officer completing this certificate verifies only the identity of the individual who signed the document to which this certificate is attached, and not the truthfulness, accuracy, or validity of that document.

STATE OF CALIFORNIA

County of Orange }

On February 7, 2018 before me, Irene Luong, Notary Public,
Date Insert Name of Notary exactly as it appears on the official seal

personally appeared Yung T. Mullick
Name(s) of Signer(s)

who proved to me on the basis of satisfactory evidence to be the person(s) whose name(s) is/are subscribed to the within instrument and acknowledged to me that he/she/they executed the same in his/her/their authorized capacity(ies), and that by his/her/their signature(s) on the instrument the person(s), or the entity upon behalf of which the person(s) acted, executed the instrument.

I certify under PENALTY OF PERJURY under the laws of the State of California that the foregoing paragraph is true and correct.

Witness my hand and official seal.

Signature Irene Luong
Signature of Notary Public Irene Luong

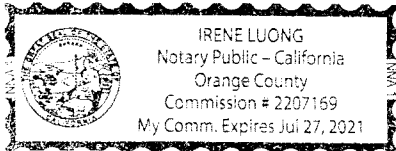

Place Notary Seal Above

OPTIONAL

Though the information below is not required by law, it may prove valuable to persons relying on the document and could prevent fraudulent removal and reattachment of the form to another document.

Description of Attached Document

Title or Type of Document: _____

Document Date: _____ Number of Pages: _____

Signer(s) Other Than Named Above: _____

Capacity(ies) Claimed by Signer(s)

Signer's Name: _____

- Individual
- Corporate Officer — Title(s): _____
- Partner Limited General
- Attorney in Fact
- Trustee
- Guardian or Conservator
- Other: _____

**RIGHT THUMBPRINT
OF SIGNER**

Top of thumb here

Signer is Representing:

Signer's Name: _____

- Individual
- Corporate Officer — Title(s): _____
- Partner Limited General
- Attorney in Fact
- Trustee
- Guardian or Conservator
- Other: _____

**RIGHT THUMBPRINT
OF SIGNER**

Top of thumb here

Signer is Representing:

POWER OF ATTORNEY

RLI Insurance Company Contractors Bonding and Insurance Company

9025 N. Lindbergh Dr. Peoria, IL 61615
Phone: 800-645-2402

Know All Men by These Presents:

That this Power of Attorney is not valid or in effect unless attached to the bond which it authorizes executed, but may be detached by the approving officer if desired.

That **RLI Insurance Company** and/or **Contractors Bonding and Insurance Company**, each an Illinois corporation, (separately and together, the "Company") do hereby make, constitute and appoint:

James W. Moilanen, Yung T. Mullick, Stephanie Hoang, jointly or severally

in the City of Mission Viejo, State of California its true and lawful Agent(s) and Attorney(s) in Fact, with full power and authority hereby conferred, to sign, execute, acknowledge and deliver for and on its behalf as Surety, in general, any and all bonds and undertakings in an amount not to exceed Twenty Five Million Dollars (\$25,000,000.00) for any single obligation.

The acknowledgment and execution of such bond by the said Attorney in Fact shall be as binding upon the Company as if such bond had been executed and acknowledged by the regularly elected officers of the Company.

RLI Insurance Company and/or **Contractors Bonding and Insurance Company**, as applicable, have each further certified that the following is a true and exact copy of a Resolution adopted by the Board of Directors of each such corporation, and is now in force, to-wit:

"All bonds, policies, undertakings, Powers of Attorney or other obligations of the corporation shall be executed in the corporate name of the Company by the President, Secretary, any Assistant Secretary, Treasurer, or any Vice President, or by such other officers as the Board of Directors may authorize. The President, any Vice President, Secretary, any Assistant Secretary, or the Treasurer may appoint Attorneys in Fact or Agents who shall have authority to issue bonds, policies or undertakings in the name of the Company. The corporate seal is not necessary for the validity of any bonds, policies, undertakings, Powers of Attorney or other obligations of the corporation. The signature of any such officer and the corporate seal may be printed by facsimile."

IN WITNESS WHEREOF, the **RLI Insurance Company** and/or **Contractors Bonding and Insurance Company**, as applicable, have caused these presents to be executed by its respective Vice President with its corporate seal affixed this 18th day of January, 2018.

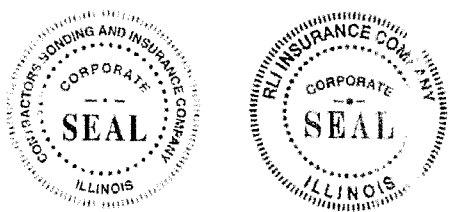

RLI Insurance Company
Contractors Bonding and Insurance Company
By: B. W. Davis
Barton W. Davis Vice President

State of Illinois }
County of Peoria } SS

CERTIFICATE

On this 18th day of January, 2018, before me, a Notary Public, personally appeared Barton W. Davis, who being by me duly sworn, acknowledged that he signed the above Power of Attorney as the aforesaid officer of the **RLI Insurance Company** and/or **Contractors Bonding and Insurance Company** and acknowledged said instrument to be the voluntary act and deed of said corporation.

I, the undersigned officer of **RLI Insurance Company** and/or **Contractors Bonding and Insurance Company**, do hereby certify that the attached Power of Attorney is in full force and effect and is irrevocable; and furthermore, that the Resolution of the Company as set forth in the Power of Attorney, is now in force. In testimony whereof, I have hereunto set my hand and the seal of the **RLI Insurance Company** and/or **Contractors Bonding and Insurance Company** this 7th day of February, 2018.

By: Gretchen L. Johnigk
Gretchen L. Johnigk Notary Public

RLI Insurance Company
Contractors Bonding and Insurance Company
By: Jean M. Stephenson
Jean M. Stephenson Corporate Secretary



STATE OF CALIFORNIA
DEPARTMENT OF INSURANCE
SAN FRANCISCO

Amended

Certificate of Authority

THIS IS TO CERTIFY that, pursuant to the Insurance Code of the State of California,

Contractors Bonding and Insurance Company

of Illinois, organized under the laws of Illinois, subject to its Articles of Incorporation or other fundamental organizational documents, is hereby authorized to transact within this State, subject to all provisions of this Certificate, the following classes of insurance:

**Fire, Marine, Surety, Plate Glass, Liability,
Boiler and Machinery, Burglary, Sprinkler,
Team and Vehicle, Automobile, Legal, and Miscellaneous**

as such classes are now or may hereafter be defined in the Insurance Laws of the State of California.

THIS CERTIFICATE is expressly conditioned upon the holder hereof now and hereafter being in full compliance with all, and not in violation of any, of the applicable laws and lawful requirements made under authority of the laws of the State of California as long as such laws or requirements are in effect and applicable, and as such laws and requirements now are, or may hereafter be changed or amended.

IN WITNESS WHEREOF, effective as of the 20th day of March, 2015, I have hereunto set my hand and caused my official seal to be affixed this 20th day of March, 2015.

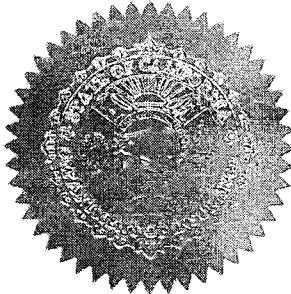

Dave Jones
Insurance Commissioner

Valerie Sarfaty
for Nettie Hoge
Chief Deputy

By

NOTICE:

Qualification with the Secretary of State must be accomplished as required by the California Corporations Code promptly after issuance of this Certificate of Authority. Failure to do so will be a violation of Insurance Code section 701 and will be grounds for revoking this Certificate of Authority pursuant to the covenants made in the application therefor and the conditions contained herein.

ALL-PURPOSE CERTIFICATE OF ACKNOWLEDGMENT

A notary public or other officer completing this certificate verifies only the identity of the individual who signed the document to which this certificate is attached, and not the truthfulness, accuracy, or validity of that document.

State of California)

County of LOS ANGELES)

On February 7, 2018 before me, Amy Elise Moody, Notary Public
(Here insert name and title of the officer)

personally appeared, Jose Guadalupe Carraval,
 who proved to me on the basis of satisfactory evidence to be the person(s) whose name(s) is are subscribed to the within instrument and acknowledged to me that he/she/they executed the same in his/her/their authorized capacity(ies), and that by his/her/their signature(s) on the instrument the person(s), or the entity upon behalf of which the person(s) acted, executed the instrument.

I certify under PENALTY OF PERJURY under the laws of the State of California that the foregoing paragraph is true and correct.

WITNESS my hand and official seal.

Amy E. Moody
 Signature _____ (Seal)

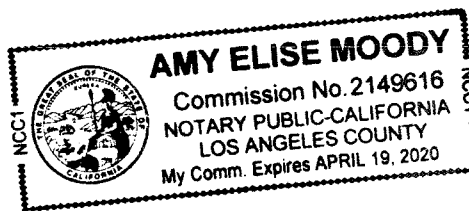

ADDITIONAL OPTIONAL INFORMATION

DESCRIPTION OF THE ATTACHED DOCUMENT
Bid Bond
(Title or description of attached document)

(Title or description of attached document continued)

Number of Pages _____ Document Date _____

CAPACITY CLAIMED BY THE SIGNER

Individual (s)

Corporate Officer
President
(Title)

Partner(s)

Attorney-in-Fact

Trustee(s)

Other _____

INSTRUCTIONS FOR COMPLETING THIS FORM

This form complies with current California statutes regarding notary wording and, if needed, should be completed and attached to the document. Acknowledgments from other states may be completed for documents being sent to that state so long as the wording does not require the California notary to violate California notary law.

- State and County information must be the State and County where the document signer(s) personally appeared before the notary public for acknowledgment.
- Date of notarization must be the date that the signer(s) personally appeared which must also be the same date the acknowledgment is completed.
- The notary public must print his or her name as it appears within his or her commission followed by a comma and then your title (notary public).
- Print the name(s) of document signer(s) who personally appear at the time of notarization.
- Indicate the correct singular or plural forms by crossing off incorrect forms (i.e. ~~he~~ she/~~they~~ is /are) or circling the correct forms. Failure to correctly indicate this information may lead to rejection of document recording.
- The notary seal impression must be clear and photographically reproducible. Impression must not cover text or lines. If seal impression smudges, re-seal if a sufficient area permits, otherwise complete a different acknowledgment form.
- Signature of the notary public must match the signature on file with the office of the county clerk.
 - ❖ Additional information is not required but could help to ensure this acknowledgment is not misused or attached to a different document.
 - ❖ Indicate title or type of attached document, number of pages and date.
 - ❖ Indicate the capacity claimed by the signer. If the claimed capacity is a corporate officer, indicate the title (i.e. CEO, CFO, Secretary).
- Securely attach this document to the signed document with a staple.



- Company Profile
- Company Search
- Company Search Results
- Company Information
- Old Company Names
- Agent for Service
- Reference Information
- NAIC Group List
- Lines of Business
- Workers' Compensation
- Complaint and Request for Action/Appeals
- Contact Information
- Financial Statements PDF's
 - Annual Statements
 - Quarterly Statements
- Company Complaint
 - Company Performance & Comparison Data
 - Company Enforcement Action
 - Composite Complaints Studies
- Additional Info
 - Find A Company Representative In Your Area
 - View Financial Disclaimer

COMPANY PROFILE

Company Information

CONTRACTORS BONDING AND INSURANCE COMPANY
9025 N. LINDBERGH DRIVE
PEORIA, IL 61615

Old Company Names	Effective Date
CONTRACTORS BONDING AND INSURANCE COMPANY DBA CBIC BONDING AND INSURANCE COMPANY	12/31/1992

Agent For Service

LISA SIRMAN
 801 S. FIGUEROA STREET
 SUITE 200
 LOS ANGELES CA 90017

Reference Information

NAIC #:	37206
California Company ID #:	3000-7
Date Authorized in California:	05/31/1985
License Status:	UNLIMITED-NORMAL
Company Type:	Property & Casualty
State of Domicile:	ILLINOIS

back to top

NAIC Group List

NAIC Group #: 0783 RLI INS GRP

Lines Of Business

The company is authorized to transact business within these lines of insurance. For an explanation of any of these terms, please refer to the glossary.

- AUTOMOBILE
- BOILER AND MACHINERY
- BURGLARY
- FIRE
- LEGAL INSURANCE
- LIABILITY
- MARINE
- MISCELLANEOUS
- PLATE GLASS
- SPRINKLER
- SURETY
- TEAM AND VEHICLE

Riverside County Contract No. 18-03-004

Contract

THIS CONTRACT is entered into at Riverside, California as of the date set forth below is between County of Riverside hereafter called "County" and CT & T Concrete Paving, Inc., hereafter called "Contractor".

WITNESSETH

Recitals:

1. Contractor has submitted to County his Contractor's Proposal for the construction of County Project, Mecca Area sidewalks Project, Community of Mecca, Project No. C6-0069, State Project No. ATPL-5956(258), in strict accordance with the Contract Documents identified below and County has accepted said Proposal.
2. Contractor states that he has reexamined his Contractor's Proposal and found it to be correct, has ascertained that his subcontractors are properly licensed and possess the requisite skill and forces, has reexamined the site and Contract Documents and is of the opinion that he can presently do the work in accordance with the Contract Documents for the money set forth in his Proposal to be paid as provided in the Contract Documents.

Agreement:

It is agreed by the parties as follows:

1. Contract Documents

The entire Contract consists of the following: (a) The Construction Contract, (b) The Notice to Bidders, (c) The Instruction to Bidders, (d) The Bid, (e) The Bid Bond, (f) The Payment Bond, (g) The Performance Bond, (h) The General Conditions, (i) The Special Provisions, (j) The Standard Specifications of the State of California Department of Transportation edition of 2015 as modified in other portions of the Contract Documents and as amended by the State of California Department of Transportation, (k) The Standard Plans of the Department of Transportation identified on the plans or in the Special Provisions, (l) The Plans, (m) Addenda 1, 2, (n) The Determination of Prevailing Wage Rates for Public Works, (o) Any Change Orders issued, and (p) Any additional or supplemental specifications, notice, instructions and drawings issued in accordance with the provisions of the Contract Documents. All of said Documents presently in existence are by this reference incorporated herein with like effect as if here set forth in full and upon the proper issuance of other documents they shall likewise be deemed incorporated. The Bid Bond is exonerated upon execution of this Contract, the Payment Bond and Performance Bond.

2. The Work

Contractor shall do all tasks necessary to construct the work generally described in Recital No. 1 in accordance with the Contract Documents.

3. Prosecution, Progress and Liquidated Damages

Attention is directed to the provisions in Section 8-1.04, "Start of Job Site Activities", Section 8-1.05, "Time", and in Section 8-1.10 "Liquidated Damages" of the Standard Specifications and these Special Provisions.

Standard Specification Section 8-1.04B, "Standard Start" is modified to read as follows:

The Contractor shall begin work within fifteen (15) calendar days, or as revised in the Special Provisions, of the date stated within the written "Notice to Proceed".

The Contractor shall notify the Engineer, in writing, of the Contractor's intent to begin work at least 72 hours before work is begun. If the project has more than one (1) location of work, Contractor shall submit a separate notice for each location. The notice shall be delivered to the Transportation Department's Construction Engineer and shall specify the date the Contractor intends to start at said location.

Should the Contractor begin work in advance of receiving a written "Notice to Proceed", any work performed by the Contractor in advance of the date stated in the "Notice to Proceed" shall be considered as having been done by the Contractor at his own risk and as a volunteer and subject to the following:

- A. The Contractor shall, on commencing operations, take all precautions required for public safety and shall observe all the provisions in the Specifications and the Special Provisions.
- B. All work done according to the Contract, prior to the issuance of the "Notice to Proceed", will be considered authorized work and will be paid for as provided in the contract.
- C. The Contractor shall not be entitled to any additional compensation or an extension of time for any delay, hindrance or interference caused by or attributable to commencement of work prior to the issuance of the "Notice to Proceed".

4. Compensation

Contractor shall be paid in the manner set forth in the Contract Documents the amount of his Proposal as accepted by County, the above rates, subject to additions and deductions as provided in the Contract Documents. Said Proposal is on file in the Office of the Clerk of the Board of Supervisors of County.

Mecca Area Sidewalks Project
Community of Mecca
Project No. C6-0069
State Project No. ATPL-5956(258)

Contract

ITEM No.	ITEM CODE	ITEM	UNIT	ESTIMATED QUANTITY	ITEM PRICE (IN FIGURES)	TOTAL (IN FIGURES)
1	066102	DUST ABATEMENT	LS	1	5,000.00	5,000.00
2	074020	WATER POLLUTION CONTROL	LS	1	2,000.00	2,000.00
3	100100	DEVELOP WATER SUPPLY	LS	1	4,500.00	4,500.00
4	120100	TRAFFIC CONTROL SYSTEM	LS	1	6,000.00	6,000.00
5	170103	CLEARING AND GRUBBING	LS	1	8,000.00	8,000.00
6	011503	UNDER SIDEWALK DRAIN CAST IN PLACE (CRS 309)	EA	6	200.00	1,200.00
7	190101	ROADWAY EXCAVATION	CY	180	79.00	14,220.00
8	260203	CLASS 2 AGGREGATE BASE	CY	1,880	25.00	47,000.00
9	390130	HOT MIX ASPHALT	TON	390	112.00	43,680.00
10	015602	FUNDING AWARENESS SIGN	EA	5	750.00	3,750.00
11	017302	MINOR CONCRETE (CROSS-GUTTER) (CRS 209)	SQFT	1,000	12.00	12,000.00
12	017303	MINOR CONCRETE (SPANDREL) (CRS 209)	SQFT	2,000	14.00	28,000.00
13	017304	MINOR CONCRETE (CURB AND GUTTER) (CRS 200)	LF	3,500	40.00	140,000.00
14	017310	MINOR CONCRETE (DRIVEWAY APPROACH) (CRS 207)	SQFT	6,000	7.00	42,000.00
15	017315	MINOR CONCRETE (CURB RAMP) (CRS 403 - CASE A)	EA	3	3,000.00	9,000.00
16	017316	MINOR CONCRETE (CURB RAMP) (CRS 403 - CASE B)	EA	4	3,400.00	13,600.00
17	731516	MINOR CONCRETE (DRIVEWAY)	SQFT	2,035	7.00	14,245.00
18	731521	MINOR CONCRETE (SIDEWALK)	SQFT	16,000	5.65	90,400.00
19	803050	REMOVE (AND REPLACE) CHAIN LINK FENCE	LF	275	40.00	11,000.00
20	810230	PAVEMENT MARKER (RETROREFLECTIVE)	EA	6	99.00	594.00
21	820610	RELOCATE ROADSIGN SIGNS	EA	10	242.00	2,420.00
22	840519	THERMOPLASTIC CROSSWALK AND PAVEMENT MARKING	SQFT	260	6.60	1,716.00
23	840656	PAINT TRAFFIC STRIPE (2-COAT)	LF	1,110	1.10	1,221.00
24	010602	MISCELLANEOUS WORK (AS DIRECTED)	FA	1	35,000.00	35,000.00

PROJECT TOTAL:
ITEMS 1-24

Five hundred thirty six thousand, five hundred forty six dollars and zero cents

\$536,546.00

"WORDS"

Mecca Area Sidewalks Project
Community of Mecca
Project No. C6-0069
State Project No. ATPL-5956(258)

IN WITNESS WHEREOF the parties hereto have executed this Contract as of the date set forth below.

COUNTY OF RIVERSIDE

CT & T CONCRETE PAVING, INC.

BY: 

BY: 

CHUCK WASHINGTON
Chairman, Board of Supervisors

DATED: APR 10 2018

TITLE: President
(If Corporation, affix Seal)

ATTEST:

ATTEST:

Kecia Harper-Ihem, Clerk of the Board

BY: 

TITLE: _____

Deputy

Licensed in accordance with an act providing
for the registration of Contractors,

License No.: 875627

Federal Employer Identification Number:

20-2642225

FORM APPROVED COUNTY COUNSEL

BY: 

3/14/18
DATE

KRISTINE BELL-VALDEZ

Department of Industrial Relations Registration Number:

1000025154

BY _____

"County"

"Corporation"
(Seal)

ALL - PURPOSE CERTIFICATE OF ACKNOWLEDGMENT

A notary public or other officer completing this certificate verifies only the identity of the individual who signed the document to which this certificate is attached, and not the truthfulness, accuracy, or validity of that document.

State of California)

County of Los Angeles)

On February 15, 2018 before me, Amy Elise Moody, Notary Public,
(Here insert name and title of the officer)

personally appeared, Jose Guadalupe Carvajal,
 who proved to me on the basis of satisfactory evidence to be the person(s) whose name(s) ~~is~~ are subscribed to the within instrument and acknowledged to me that ~~he~~ she/they executed the same in ~~his~~ her/their authorized capacity(ies), and that by ~~his~~ her/their signature(s) on the instrument the person(s), or the entity upon behalf of which the person(s) acted, executed the instrument.

I certify under PENALTY OF PERJURY under the laws of the State of California that the foregoing paragraph is true and correct.

WITNESS my hand and official seal.

Amy E. Moody (Seal)
 Signature

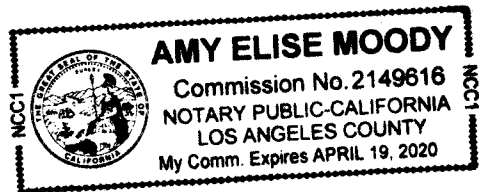

ADDITIONAL OPTIONAL INFORMATION

DESCRIPTION OF THE ATTACHED DOCUMENT

(Title or description of attached document)

(Title or description of attached document continued)

Number of Pages _____ Document Date _____

CAPACITY CLAIMED BY THE SIGNER

- Individual (s)
- Corporate Officer
President
(Title)
- Partner(s)
- Attorney-in-Fact
- Trustee(s)
- Other _____

INSTRUCTIONS FOR COMPLETING THIS FORM

This form complies with current California statutes regarding notary wording and, if needed, should be completed and attached to the document. Acknowledgments from other states may be completed for documents being sent to that state so long as the wording does not require the California notary to violate California notary law.

- State and County information must be the State and County where the document signer(s) personally appeared before the notary public for acknowledgment.
- Date of notarization must be the date that the signer(s) personally appeared which must also be the same date the acknowledgment is completed.
- The notary public must print his or her name as it appears within his or her commission followed by a comma and then your title (notary public).
- Print the name(s) of document signer(s) who personally appear at the time of notarization.
- Indicate the correct singular or plural forms by crossing off incorrect forms (i.e. ~~he/she/they~~ is /are) or circling the correct forms. Failure to correctly indicate this information may lead to rejection of document recording.
- The notary seal impression must be clear and photographically reproducible. Impression must not cover text or lines. If seal impression smudges, re-seal if a sufficient area permits, otherwise complete a different acknowledgment form.
- Signature of the notary public must match the signature on file with the office of the county clerk.
 - ❖ Additional information is not required but could help to ensure this acknowledgment is not misused or attached to a different document.
 - ❖ Indicate title or type of attached document, number of pages and date.
 - ❖ Indicate the capacity claimed by the signer. If the claimed capacity is a corporate officer, indicate the title (i.e. CEO, CFO, Secretary).
- Securely attach this document to the signed document with a staple.

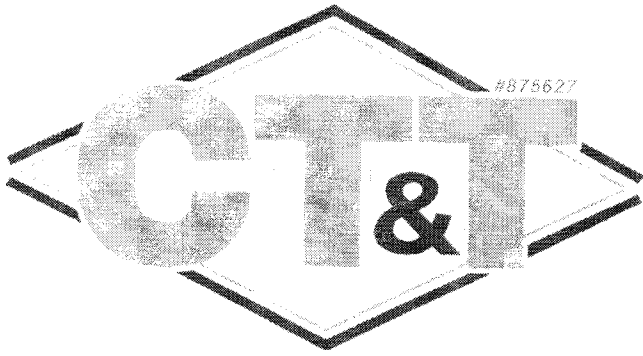

Concrete Paving, Inc.

CORPORATE RESOLUTION OF SIGNING AUTHORITY

RESOLUTION OF: CT&T Concrete Paving, Inc.

RESOLVED that the execution of Deeds, powers of attorney, transfers, assignments, contracts, obligations, certificates, and other instruments of whatever nature entered into by the Company directly or through a transfer agent or registrar for any stock company, acting in its capacity as a corporate director or exercising any and all other powers conferred upon it by the letters Patent incorporating it or by the law pertaining to such matters, shall be signed by any one of the persons listed below:

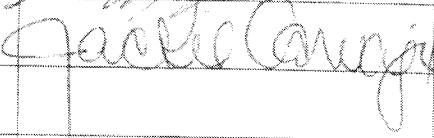
Name	Title	Specimen/Signature
Jose Carvajal	President	
Jackie Carvajal	Treasurer	

I, Jose Carvajal, the undersigned Secretary of CT&T Concrete Paving, Inc. **HEREBY CERTIFY** that the foregoing is a true and correct copy of a Resolution of the Board of Directors of said Company passed by a resolution of the said board dated on 10/27/2017 and that said Resolution is still in full force and effect.

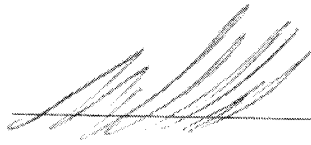
Secretary

CERTIFICATION OF RESOLUTION OF
BOARD OF DIRECTORS AND SHAREHOLDERS
OF CT&T CONCRETE PAVING, INC.

A California Corporation

I certify that:

I am the duly qualified and acting Secretary of CT&T Concrete Paving, Inc., a California Corporation.

Attached to this Certification and marked as Exhibit "A" is a true and correct copy of resolutions duly adopted by the Board of Directors of the corporation by unanimous written consent without a meeting, as authorized by California Corporations Code Section 307(b) and Section 603.

These resolutions have not been modified or rescinded and are in full force and effect at the date of this certificate.

Dated: September 1, 2015

Secretary Jose G. Carvaja

ANNUAL ORGANIZATION AND ACTION BY
UNANIMOUS WRITTEN CONSENT OF
SHAREHOLDERS AND DIRECTORS OF
CT&T CONCRETE PAVING, INC.

The undersigned, constituting all of the Directors and Shareholders of CT&T Concrete Paving, Inc., a California corporation, acting by unanimous written consent without a meeting, in accordance with California Corporations Code Section 307(b) and Section 603, and the bylaws of this corporation, hereby adopt the following annual resolutions for the corporation's 2015 year:

IT IS UNANIMOUSLY RESOLVED AS FOLLOWS:

1. Election of Directors.

The following persons are duly elected to the Board of Directors to serve in said office until their respective successors are properly designated or elected:

Name

Jose G. Carvajal

2. Election of Officers.

The following persons are duly elected to the offices indicated after the names of each, to serve in said office until their respective successors are properly designated or elected:

Name

Office

Jose G. Carvajal

President

Jose G. Carvajal

Secretary

Jaqueline Carvajal

Treasurer

3. Financial Statements

The Fiscal Year End Statements for 2015 were presented and approved by the Board Director and Shareholder.

4. Ratification.

All acts of the officers of the Corporation, Shareholders and Board of Directors of the Corporation since the last annual meeting or Annual Organization and Action By Unanimous Written Consent of the Directors and Shareholders be, and the same hereby are, ratified, confirmed, and approved in all respects.

5. Certification.

The corporate Secretary is directed to certify these resolutions and to deliver the certification in support of the authority of the officers named above to act on behalf of this corporation.

Dated: September 1, 2015

DIRECTORS:

Jose G. Carvajal

SHAREHOLDERS:

Jose G. Carvajal

Performance Bond

Recitals:

1. **CT & T Concrete Paving, Inc.** (Contractor) has entered into a Contract with COUNTY OF RIVERSIDE (County) for construction of public work known as **Mecca Area sidewalks Project, Community of Mecca, Project No. C6-0069, State Project No. ATPL-5956(258).**
2. Contractors Bonding and Insurance Company a Illinois corporation (Surety), is the Surety under this Bond.

Agreement:

We, Contractor as Principal and Surety as Surety, jointly and severally agree, state, and are bound unto County, as obligee, as follows:

1. The amount of the obligation of this Bond is 100% of the estimated contract price for the Project of **\$536,546.00 (Five hundred thirty six thousand, five hundred forty six dollars and zero cents)** and inures to the benefit of County.
2. This Bond is exonerated by Contractor doing all things to be kept and performed by it in strict conformance with the Contract Documents for this project, otherwise it remains in full force and effect for the recovery of loss, damage and expense of County resulting from failure of Contractor to so act. All of said Contract Documents are incorporated herein.
3. This obligation is binding on our successors and assigns.
4. For value received, Surety stipulates and agrees that no change, time extension, prepayment to Contractor, alteration or addition to the terms and requirements of the Contract Documents or the work to be performed thereunder shall affect its obligations hereunder and waives notice as to such matters, except the total contract price cannot be increased by more than 10% without approval of Surety.

THIS BOND is executed as of February 14, 2018

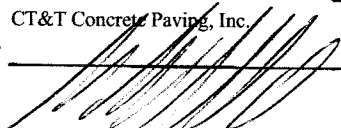
CT&T Concrete Paving, Inc.
 By 
 By _____

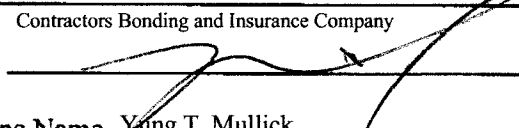
Contractors Bonding and Insurance Company
 By 
 Type Name Yang T. Mullick

Title President
 "Contractor"

Its Attorney in Fact
"Surety"

(Corporate Seal)

(Corporate Seal)

NOTE: This Bond must be executed by both parties with corporate seal affixed. All signatures must be acknowledged. (Attach acknowledgements).

CALIFORNIA ALL-PURPOSE ACKNOWLEDGMENT

A notary public or other officer completing this certificate verifies only the identity of the individual who signed the document to which this certificate is attached, and not the truthfulness, accuracy, or validity of that document.

STATE OF CALIFORNIA

County of Orange }

On February 14, 2018 before me, Irene Luong, Notary Public,
Date Insert Name of Notary exactly as it appears on the official seal

personally appeared Yung T. Mullick
Name(s) of Signer(s)

who proved to me on the basis of satisfactory evidence to be the person(s) whose name(s) is/are subscribed to the within instrument and acknowledged to me that he/she/they executed the same in his/her/their authorized capacity(ies), and that by his/her/their signature(s) on the instrument the person(s), or the entity upon behalf of which the person(s) acted, executed the instrument.

I certify under PENALTY OF PERJURY under the laws of the State of California that the foregoing paragraph is true and correct.

Witness my hand and official seal.

Signature Irene Luong
Signature of Notary Public Irene Luong

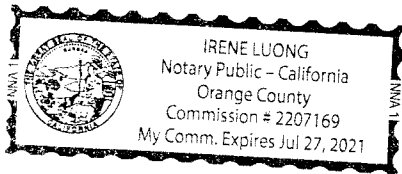

Place Notary Seal Above

OPTIONAL

Though the information below is not required by law, it may prove valuable to persons relying on the document and could prevent fraudulent removal and reattachment of the form to another document.

Description of Attached Document

Title or Type of Document: _____

Document Date: _____ Number of Pages: _____

Signer(s) Other Than Named Above: _____

Capacity(ies) Claimed by Signer(s)

Signer's Name: _____

- Individual
- Corporate Officer — Title(s): _____
- Partner Limited General
- Attorney in Fact
- Trustee
- Guardian or Conservator
- Other: _____

**RIGHT THUMBPRINT
OF SIGNER**

Top of thumb here

Signer is Representing:

Signer's Name: _____

- Individual
- Corporate Officer — Title(s): _____
- Partner Limited General
- Attorney in Fact
- Trustee
- Guardian or Conservator
- Other: _____

**RIGHT THUMBPRINT
OF SIGNER**

Top of thumb here

Signer is Representing:

POWER OF ATTORNEY

RLI Insurance Company Contractors Bonding and Insurance Company

9025 N. Lindbergh Dr. Peoria, IL 61615
Phone: 800-645-2402

Know All Men by These Presents:

That this Power of Attorney is not valid or in effect unless attached to the bond which it authorizes executed, but may be detached by the approving officer if desired.

That **RLI Insurance Company** and/or **Contractors Bonding and Insurance Company**, each an Illinois corporation, (separately and together, the "Company") do hereby make, constitute and appoint:

James W. Moilanen, Yung T. Mullick, Stephanie Hoang, jointly or severally

in the City of Mission Viejo, State of California its true and lawful Agent(s) and Attorney(s) in Fact, with full power and authority hereby conferred, to sign, execute, acknowledge and deliver for and on its behalf as Surety, in general, any and all bonds and undertakings in an amount not to exceed Twenty Five Million Dollars (\$25,000,000.00) for any single obligation.

The acknowledgment and execution of such bond by the said Attorney in Fact shall be as binding upon the Company as if such bond had been executed and acknowledged by the regularly elected officers of the Company.

RLI Insurance Company and/or **Contractors Bonding and Insurance Company**, as applicable, have each further certified that the following is a true and exact copy of a Resolution adopted by the Board of Directors of each such corporation, and is now in force, to-wit:

"All bonds, policies, undertakings, Powers of Attorney or other obligations of the corporation shall be executed in the corporate name of the Company by the President, Secretary, any Assistant Secretary, Treasurer, or any Vice President, or by such other officers as the Board of Directors may authorize. The President, any Vice President, Secretary, any Assistant Secretary, or the Treasurer may appoint Attorneys in Fact or Agents who shall have authority to issue bonds, policies or undertakings in the name of the Company. The corporate seal is not necessary for the validity of any bonds, policies, undertakings, Powers of Attorney or other obligations of the corporation. The signature of any such officer and the corporate seal may be printed by facsimile."

IN WITNESS WHEREOF, the **RLI Insurance Company** and/or **Contractors Bonding and Insurance Company**, as applicable, have caused these presents to be executed by its respective Vice President with its corporate seal affixed this 18th day of January, 2018.



RLI Insurance Company
Contractors Bonding and Insurance Company

By: B. W. Davis
Barton W. Davis Vice President

State of Illinois }
County of Peoria } SS

CERTIFICATE

On this 18th day of January, 2018, before me, a Notary Public, personally appeared Barton W. Davis, who being by me duly sworn, acknowledged that he signed the above Power of Attorney as the aforesaid officer of the **RLI Insurance Company** and/or **Contractors Bonding and Insurance Company** and acknowledged said instrument to be the voluntary act and deed of said corporation.

I, the undersigned officer of **RLI Insurance Company** and/or **Contractors Bonding and Insurance Company**, do hereby certify that the attached Power of Attorney is in full force and effect and is irrevocable; and furthermore, that the Resolution of the Company as set forth in the Power of Attorney, is now in force. In testimony whereof, I have hereunto set my hand and the seal of the **RLI Insurance Company** and/or **Contractors Bonding and Insurance Company** this 14 day of February, 2018.

By: Gretchen L. Johnnigk
Gretchen L. Johnnigk Notary Public

RLI Insurance Company
Contractors Bonding and Insurance Company

By: Jean M. Stephenson
Jean M. Stephenson Corporate Secretary



ALL-PURPOSE CERTIFICATE OF ACKNOWLEDGMENT

A notary public or other officer completing this certificate verifies only the identity of the individual who signed the document to which this certificate is attached, and not the truthfulness, accuracy, or validity of that document.

State of California)

County of Los Angeles)

On February 15, 2018 before me, Amy Elise Moody, Notary Public
(Here insert name and title of the officer)

personally appeared, Jose Guadalupe Carvajal,
 who proved to me on the basis of satisfactory evidence to be the person(s) whose name(s) is are subscribed to the within instrument and acknowledged to me that he/she/they executed the same in his/her/their authorized capacity(ies), and that by his/her/their signature(s) on the instrument the person(s), or the entity upon behalf of which the person(s) acted, executed the instrument.

I certify under PENALTY OF PERJURY under the laws of the State of California that the foregoing paragraph is true and correct.

WITNESS my hand and official seal.

Amy E. Moody
 Signature _____ (Seal)

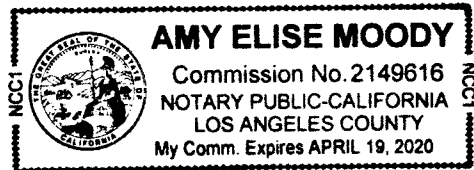

ADDITIONAL OPTIONAL INFORMATION

DESCRIPTION OF THE ATTACHED DOCUMENT

(Title or description of attached document)

(Title or description of attached document continued)

Number of Pages _____ Document Date _____

CAPACITY CLAIMED BY THE SIGNER

Individual (s)

Corporate Officer
President
(Title)

Partner(s)

Attorney-in-Fact

Trustee(s)

Other _____

INSTRUCTIONS FOR COMPLETING THIS FORM

This form complies with current California statutes regarding notary wording and, if needed, should be completed and attached to the document. Acknowledgments from other states may be completed for documents being sent to that state so long as the wording does not require the California notary to violate California notary law.

- State and County information must be the State and County where the document signer(s) personally appeared before the notary public for acknowledgment.
- Date of notarization must be the date that the signer(s) personally appeared which must also be the same date the acknowledgment is completed.
- The notary public must print his or her name as it appears within his or her commission followed by a comma and then your title (notary public).
- Print the name(s) of document signer(s) who personally appear at the time of notarization.
- Indicate the correct singular or plural forms by crossing off incorrect forms (i.e. ~~he~~/she/~~they~~ is /are) or circling the correct forms. Failure to correctly indicate this information may lead to rejection of document recording.
- The notary seal impression must be clear and photographically reproducible. Impression must not cover text or lines. If seal impression smudges, re-seal if a sufficient area permits, otherwise complete a different acknowledgment form.
- Signature of the notary public must match the signature on file with the office of the county clerk.
 - ❖ Additional information is not required but could help to ensure this acknowledgment is not misused or attached to a different document.
 - ❖ Indicate title or type of attached document, number of pages and date.
 - ❖ Indicate the capacity claimed by the signer. If the claimed capacity is a corporate officer, indicate the title (i.e. CEO, CFO, Secretary).
- Securely attach this document to the signed document with a staple.

Payment Bond
(Public Works - Civil Code §9550 et seq.)

The makers of this Bond are CT & T Concrete Paving, Inc., as Principal and Original Contractor and Contractors Bonding and Insurance Company, a corporation, authorized to issue Surety Bonds in California, as Surety, and this Bond is issued in conjunction with that certain public works contract to be executed between Principal and COUNTY OF RIVERSIDE a public entity, as Owner, for \$536,546.00 (Five hundred thirty six thousand, five hundred forty six dollars and zero cents), the total amount payable. The amount of this bond is one hundred percent (100%) of said sum. Said contract is for public work generally consisting Mecca Area sidewalks Project, Community of Mecca, Project No. C6-0069, State Project No. ATPL-5956(258).

The beneficiaries of this Bond are as is stated in 9554 of the Civil Code and requirements and conditions of this Bond are as is set forth in 9554, 9558, 9560 and 9564 of said code. Without notice, Surety consents to extension of time for performance, change in requirements, amount of compensation, or prepayment under said contract.

Dated: February 14th 2018

CT&T Concrete Paving, Inc.
Original Contractor – Principal

Contractors Bonding and Insurance Company
Surety

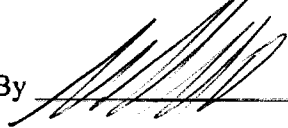
By 

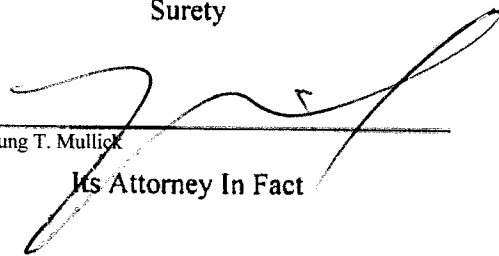
By 
Yung T. Mullick
Its Attorney In Fact

Title President
(If corporation, affix seal)

(Corporate Seal)

(Corporate Seal)

STATE OF _____ }
COUNTY OF _____ } ss. SURETY'S ACKNOWLEDGEMENT

On _____ before me, _____ personally appeared, _____, known to me, or proved to me on the basis of satisfactory evidence, to be the person whose name is subscribed to the within instrument and acknowledged to me that he executed the same in his authorized capacities, and that by his signature on the instrument the person, or the entity upon behalf of which the person acted, executed the instrument.

WITNESS my hand and official seal.

Signature of Notary Public

Notary Public (Seal)

NOTE: This Bond must be executed by both parties with corporate seal affixed. All signatures must be acknowledged. (Attach acknowledgements).

CALIFORNIA ALL-PURPOSE ACKNOWLEDGMENT

A notary public or other officer completing this certificate verifies only the identity of the individual who signed the document to which this certificate is attached, and not the truthfulness, accuracy, or validity of that document.

STATE OF CALIFORNIA

County of Orange }

On February 14, 2018 before me, Irene Luong, Notary Public,
Date Insert Name of Notary exactly as it appears on the official seal

personally appeared Yung T. Mullick
Name(s) of Signer(s)

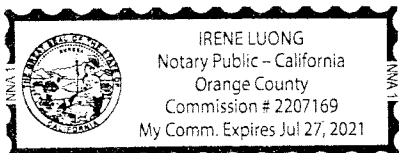

Place Notary Seal Above

who proved to me on the basis of satisfactory evidence to be the person(s) whose name(s) is/are subscribed to the within instrument and acknowledged to me that he/she/they executed the same in his/her/their authorized capacity(ies), and that by his/her/their signature(s) on the instrument the person(s), or the entity upon behalf of which the person(s) acted, executed the instrument.

I certify under PENALTY OF PERJURY under the laws of the State of California that the foregoing paragraph is true and correct.

Witness my hand and official seal.

Signature Irene Luong
Signature of Notary Public Irene Luong

OPTIONAL

Though the information below is not required by law, it may prove valuable to persons relying on the document and could prevent fraudulent removal and reattachment of the form to another document.

Description of Attached Document

Title or Type of Document: _____

Document Date: _____ Number of Pages: _____

Signer(s) Other Than Named Above: _____

Capacity(ies) Claimed by Signer(s)

Signer's Name: _____

- Individual
- Corporate Officer — Title(s): _____
- Partner Limited General
- Attorney in Fact
- Trustee
- Guardian or Conservator
- Other: _____



Signer is Representing: _____

Signer's Name: _____

- Individual
- Corporate Officer — Title(s): _____
- Partner Limited General
- Attorney in Fact
- Trustee
- Guardian or Conservator
- Other: _____

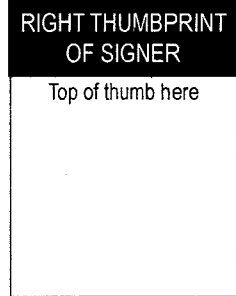

Signer is Representing: _____

POWER OF ATTORNEY

RLI Insurance Company Contractors Bonding and Insurance Company

9025 N. Lindbergh Dr. Peoria, IL 61615
Phone: 800-645-2402

Know All Men by These Presents:

That this Power of Attorney is not valid or in effect unless attached to the bond which it authorizes executed, but may be detached by the approving officer if desired.

That **RLI Insurance Company** and/or **Contractors Bonding and Insurance Company**, each an Illinois corporation, (separately and together, the "Company") do hereby make, constitute and appoint:

James W. Moilanen, Yung T. Mullick, Stephanie Hoang, jointly or severally

in the City of Mission Viejo, State of California its true and lawful Agent(s) and Attorney(s) in Fact, with full power and authority hereby conferred, to sign, execute, acknowledge and deliver for and on its behalf as Surety, in general, any and all bonds and undertakings in an amount not to exceed Twenty Five Million Dollars (\$25,000,000.00) for any single obligation.

The acknowledgment and execution of such bond by the said Attorney in Fact shall be as binding upon the Company as if such bond had been executed and acknowledged by the regularly elected officers of the Company.

RLI Insurance Company and/or **Contractors Bonding and Insurance Company**, as applicable, have each further certified that the following is a true and exact copy of a Resolution adopted by the Board of Directors of each such corporation, and is now in force, to-wit:

"All bonds, policies, undertakings, Powers of Attorney or other obligations of the corporation shall be executed in the corporate name of the Company by the President, Secretary, any Assistant Secretary, Treasurer, or any Vice President, or by such other officers as the Board of Directors may authorize. The President, any Vice President, Secretary, any Assistant Secretary, or the Treasurer may appoint Attorneys in Fact or Agents who shall have authority to issue bonds, policies or undertakings in the name of the Company. The corporate seal is not necessary for the validity of any bonds, policies, undertakings, Powers of Attorney or other obligations of the corporation. The signature of any such officer and the corporate seal may be printed by facsimile."

IN WITNESS WHEREOF, the **RLI Insurance Company** and/or **Contractors Bonding and Insurance Company**, as applicable, have caused these presents to be executed by its respective Vice President with its corporate seal affixed this 18th day of January, 2018.



RLI Insurance Company
Contractors Bonding and Insurance Company

By: B. W. Davis
Barton W. Davis Vice President

State of Illinois }
County of Peoria } SS

CERTIFICATE

On this 18th day of January, 2018, before me, a Notary Public, personally appeared Barton W. Davis, who being by me duly sworn, acknowledged that he signed the above Power of Attorney as the aforesaid officer of the **RLI Insurance Company** and/or **Contractors Bonding and Insurance Company** and acknowledged said instrument to be the voluntary act and deed of said corporation.

I, the undersigned officer of **RLI Insurance Company** and/or **Contractors Bonding and Insurance Company**, do hereby certify that the attached Power of Attorney is in full force and effect and is irrevocable; and furthermore, that the Resolution of the Company as set forth in the Power of Attorney, is now in force. In testimony whereof, I have hereunto set my hand and the seal of the **RLI Insurance Company** and/or **Contractors Bonding and Insurance Company** this 14 day of February, 2018.

By: Gretchen L. Johnigk
Gretchen L. Johnigk Notary Public

RLI Insurance Company
Contractors Bonding and Insurance Company

By: Jean M. Stephenson
Jean M. Stephenson Corporate Secretary



ALL-PURPOSE CERTIFICATE OF ACKNOWLEDGMENT

A notary public or other officer completing this certificate verifies only the identity of the individual who signed the document to which this certificate is attached, and not the truthfulness, accuracy, or validity of that document.

State of California)

County of Los Angeles)

On February 15, 2018 before me, Amy Elise Moody, Notary Public
(Here insert name and title of the officer)

personally appeared, Jose Guadalupe Carvajal,
 who proved to me on the basis of satisfactory evidence to be the person(s) whose name(s) is are subscribed to the within instrument and acknowledged to me that he she/they executed the same in his her/their authorized capacity(ies), and that by his her/their signature(s) on the instrument the person(s), or the entity upon behalf of which the person(s) acted, executed the instrument.

I certify under PENALTY OF PERJURY under the laws of the State of California that the foregoing paragraph is true and correct.

WITNESS my hand and official seal.

Amy E. Moody
 Signature (Seal)

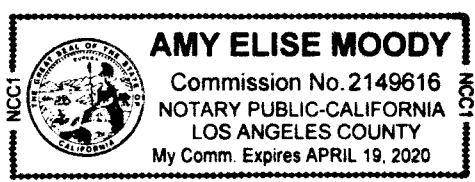

ADDITIONAL OPTIONAL INFORMATION

DESCRIPTION OF THE ATTACHED DOCUMENT

(Title or description of attached document)

(Title or description of attached document continued)

Number of Pages _____ Document Date _____

INSTRUCTIONS FOR COMPLETING THIS FORM

This form complies with current California statutes regarding notary wording and, if needed, should be completed and attached to the document. Acknowledgments from other states may be completed for documents being sent to that state so long as the wording does not require the California notary to violate California notary law.

- State and County information must be the State and County where the document signer(s) personally appeared before the notary public for acknowledgment.
- Date of notarization must be the date that the signer(s) personally appeared which must also be the same date the acknowledgment is completed.
- The notary public must print his or her name as it appears within his or her commission followed by a comma and then your title (notary public).
- Print the name(s) of document signer(s) who personally appear at the time of notarization.
- Indicate the correct singular or plural forms by crossing off incorrect forms (i.e. ~~he~~/she/~~they~~ - is /are) or circling the correct forms. Failure to correctly indicate this information may lead to rejection of document recording.
- The notary seal impression must be clear and photographically reproducible. Impression must not cover text or lines. If seal impression smudges, re-seal if a sufficient area permits, otherwise complete a different acknowledgment form.
- Signature of the notary public must match the signature on file with the office of the county clerk.
 - ❖ Additional information is not required but could help to ensure this acknowledgment is not misused or attached to a different document.
 - ❖ Indicate title or type of attached document, number of pages and date.
 - ❖ Indicate the capacity claimed by the signer. If the claimed capacity is a corporate officer, indicate the title (i.e. CEO, CFO, Secretary).
- Securely attach this document to the signed document with a staple.

CAPACITY CLAIMED BY THE SIGNER

Individual (s)

Corporate Officer
President
 (Title)

Partner(s)

Attorney-in-Fact

Trustee(s)

Other _____



- Company Profile
- Company Search
- Company Search Results
- Company Information
- Old Company Names
- Agent for Service
- Reference Information
- NAIC Group List
- Lines of Business
- Workers' Compensation
- Complaint and Request for Action/Appeals
- Contact Information
- Financial Statements PDF's
- Annual Statements
- Quarterly Statements
- Company Complaint
- Company Performance & Comparison Data
- Company Enforcement Action
- Composite Complaints Studies
- Additional Info
- Find A Company Representative In Your Area
- View Financial Disclaimer

COMPANY PROFILE

Company Information

CONTRACTORS BONDING AND INSURANCE COMPANY

9025 N. LINDBERGH DRIVE
PEORIA, IL 61615

Old Company Names

Effective Date

CONTRACTORS BONDING AND INSURANCE COMPANY DBA CBIC BONDING AND INSURANCE COMPANY 12/31/1992

Agent For Service

LISA SIRMAN
801 S. FIGUEROA STREET
SUITE 200
LOS ANGELES CA 90017

Reference Information

NAIC #:	37206
California Company ID #:	3000-7
Date Authorized in California:	05/31/1985
License Status:	UNLIMITED-NORMAL
Company Type:	Property & Casualty
State of Domicile:	ILLINOIS

back to top

NAIC Group List

NAIC Group #: 0783 RLI INS GRP

Lines Of Business

The company is authorized to transact business within these lines of insurance. For an explanation of any of these terms, please refer to the glossary.

- AUTOMOBILE
- BOILER AND MACHINERY
- BURGLARY
- FIRE
- LEGAL INSURANCE
- LIABILITY
- MARINE
- MISCELLANEOUS
- PLATE GLASS
- SPRINKLER
- ✓ SURETY
- TEAM AND VEHICLE



CERTIFICATE OF LIABILITY INSURANCE

DATE (MM/DD/YYYY)
02/27/2018

THIS CERTIFICATE IS ISSUED AS A MATTER OF INFORMATION ONLY AND CONFERS NO RIGHTS UPON THE CERTIFICATE HOLDER. THIS CERTIFICATE DOES NOT AFFIRMATIVELY OR NEGATIVELY AMEND, EXTEND OR ALTER THE COVERAGE AFFORDED BY THE POLICIES BELOW. THIS CERTIFICATE OF INSURANCE DOES NOT CONSTITUTE A CONTRACT BETWEEN THE ISSUING INSURER(S), AUTHORIZED REPRESENTATIVE OR PRODUCER, AND THE CERTIFICATE HOLDER.

IMPORTANT: If the certificate holder is an ADDITIONAL INSURED, the policy(ies) must be endorsed. If SUBROGATION IS WAIVED, subject to the terms and conditions of the policy, certain policies may require an endorsement. A statement on this certificate does not confer rights to the certificate holder in lieu of such endorsement(s).

PRODUCER PATRICK MCRAE INSURANCE SERVICES 1265 N. MANASSERO SUITE 303 ANAHEIM HILLS, CA 92807	LICENSE NO. 0637431	CONTACT NAME: PATRICK MCRAE PHONE (A/C, No, Ext): (714) 779-6999 E-MAIL ADDRESS: p.mcrae@sbcglobal.net	FAX (A/C, No): (714) 779-6903
	INSURER(S) AFFORDING COVERAGE		NAIC #
INSURED PERSONNEL STAFFING GROUP, LLC DBA KBS STAFFING CT & T CONCRETE PAVING INC. 324 S DIAMOND BAR BLVD. PMB 275 DIAMOND BAR CA 91765	INSURER A: GEMINI INSURANCE COMPANY		10833
	INSURER B: WESCO INSURANCE COMPANY		25011
	INSURER C: NATIONAL UNION FIRE INSURANCE CO. OF		19445
	INSURER D: GREAT AMERICAN INSURANCE CO. OF NY		22136
	INSURER E: PROTECTIVE INSURANCE COMPANY		12416
	INSURER F:		

COVERAGES **CERTIFICATE NUMBER:** **REVISION NUMBER:**

THIS IS TO CERTIFY THAT THE POLICIES OF INSURANCE LISTED BELOW HAVE BEEN ISSUED TO THE INSURED NAMED ABOVE FOR THE POLICY PERIOD INDICATED. NOTWITHSTANDING ANY REQUIREMENT, TERM OR CONDITION OF ANY CONTRACT OR OTHER DOCUMENT WITH RESPECT TO WHICH THIS CERTIFICATE MAY BE ISSUED OR MAY PERTAIN, THE INSURANCE AFFORDED BY THE POLICIES DESCRIBED HEREIN IS SUBJECT TO ALL THE TERMS, EXCLUSIONS AND CONDITIONS OF SUCH POLICIES. LIMITS SHOWN MAY HAVE BEEN REDUCED BY PAID CLAIMS.

INSR LTR	TYPE OF INSURANCE	ADDL INSD	SUBR WVD	POLICY NUMBER	POLICY EFF (MM/DD/YYYY)	POLICY EXP (MM/DD/YYYY)	LIMITS
A	<input checked="" type="checkbox"/> COMMERCIAL GENERAL LIABILITY <input type="checkbox"/> CLAIMS-MADE <input checked="" type="checkbox"/> OCCUR <input checked="" type="checkbox"/> XCU <input checked="" type="checkbox"/> OCP GEN'L AGGREGATE LIMIT APPLIES PER: <input type="checkbox"/> POLICY <input checked="" type="checkbox"/> PRO-JECT <input type="checkbox"/> LOC OTHER:	X	X	VCGP023097	06/09/2017	06/09/2018	EACH OCCURRENCE \$ 1,000,000 DAMAGE TO RENTED PREMISES (Ea occurrence) \$ 50,000 MED EXP (Any one person) \$ 5,000 PERSONAL & ADV INJURY \$ 1,000,000 GENERAL AGGREGATE \$ 2,000,000 PRODUCTS - COMP/OP AGG \$ 2,000,000 EBL \$ \$1,000,000
B	<input checked="" type="checkbox"/> AUTOMOBILE LIABILITY <input checked="" type="checkbox"/> ANY AUTO <input type="checkbox"/> ALL OWNED AUTOS <input type="checkbox"/> SCHEDULED AUTOS <input checked="" type="checkbox"/> HIRED AUTOS <input checked="" type="checkbox"/> NON-OWNED AUTOS	X	X	WPP1556836 00	06/23/2017	06/23/2018	COMBINED SINGLE LIMIT (Ea accident) \$ 1,000,000 BODILY INJURY (Per person) \$ BODILY INJURY (Per accident) \$ PROPERTY DAMAGE (Per accident) \$ \$
C	<input type="checkbox"/> UMBRELLA LIAB <input checked="" type="checkbox"/> OCCUR <input checked="" type="checkbox"/> EXCESS LIAB <input type="checkbox"/> CLAIMS-MADE DED RETENTION \$			EBU 051521406	06/09/2017	06/09/2018	EACH OCCURRENCE \$ 5,000,000 AGGREGATE \$ 5,000,000 CRISIS RESPONSE \$ 250,000
E	<input checked="" type="checkbox"/> WORKERS COMPENSATION AND EMPLOYERS' LIABILITY ANY PROPRIETOR/PARTNER/EXECUTIVE OFFICER/MEMBER EXCLUDED? (Mandatory in NH) If yes, describe under DESCRIPTION OF OPERATIONS below		X	WD001486	01/01/2018	06/30/2018	<input checked="" type="checkbox"/> PER STATUTE <input type="checkbox"/> OTHER E.L. EACH ACCIDENT \$ 1,000,000 E.L. DISEASE - EA EMPLOYEE \$ 1,000,000 E.L. DISEASE - POLICY LIMIT \$ 1,000,000
D	<input checked="" type="checkbox"/> INLAND <input type="checkbox"/> MARINE/PROPERTY			IMP5021860	04/27/2017	04/27/2018	\$61,386 SCHEDULED EQUIPMENT, \$250,000 BUILDING \$20,000 BPP

DESCRIPTION OF OPERATIONS / LOCATIONS / VEHICLES (ACORD 101, Additional Remarks Schedule, may be attached if more space is required)
 EMPLOYEES ASSIGNED TO CT & T CONCRETE PAVING, INC. 324 S DIAMOND BAR BL., PMB275 DIAMOND BAR, CA 91765 - (applies only to the workers compensation)

THE COUNTY OF RIVERSIDE, ITS AGENCIES, SPECIAL DISTRICTS AND DEPARTMENTS, THEIR RESPECTIVE DIRECTOR, OFFICERS, BOARD OF SUPERVISORS, ELECTED AND APPOINTED OFFICIALS, EMPLOYEES, AGENTS, AND REPRESENTATIVES ARE NAMED AS ADDITIONAL INSURED WITH RESPECTS TO THE ABOVE MENTIONED POLICIES PER ATTACHED ENDORSEMENT(S). COVERAGE IS PRIMARY & NON-CONTRIBUTORY AS REQUIRED BY WRITTEN CONTRACT, PER ATTACHED ENDORSEMENT FORMS. WAIVER OF SUBROGATION APPLIES, IF REQUIRED BY WRITTEN CONTRACT.

* SHOULD ANY OF THE ABOVE DESCRIBED POLICIES BE CANCELLED BEFORE THE EXPIRATION DATE THEREOF, A 30 DAY WRITTEN NOTICE WILL BE ISSUED.

RE: MECCA AREA SIDEWALKS PROJECT, COMMUNITY OF MECCA, PROJECT NO. C6-0069, STATE PROJECT NO. ATPL -5956(258)

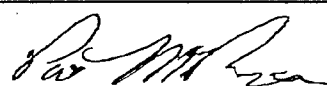
CERTIFICATE HOLDER COUNTY OF RIVERSIDE TRANSPORTATION DEPARTMENT ATTN: CONTRACTS/BIDDING UNIT 3525 14TH STREET RIVERSIDE, CA 92501	CANCELLATION SHOULD ANY OF THE ABOVE DESCRIBED POLICIES BE CANCELLED BEFORE THE EXPIRATION DATE THEREOF, NOTICE WILL BE DELIVERED IN ACCORDANCE WITH THE POLICY PROVISIONS. AUTHORIZED REPRESENTATIVE 
--	---

THIS ENDORSEMENT CHANGES THE POLICY. PLEASE READ IT CAREFULLY.

**PRIMARY AND NONCONTRIBUTORY –
OTHER INSURANCE CONDITION**

This endorsement modifies insurance provided under the following:

The following is added to the **Other Insurance** Condition and supersedes any provision to the contrary:

Primary And Noncontributory Insurance

This insurance is primary to and will not seek contribution from any other insurance available to an additional insured under your policy provided that:

- (1) The additional insured is a Named Insured under such other insurance; and
- (2) You have agreed in writing in a contract or agreement that this insurance would be primary and would not seek contribution from any other insurance available to the additional insured.



THIS ENDORSEMENT CHANGES THE POLICY. PLEASE READ IT CAREFULLY.

ADDITIONAL INSURED – OWNERS, LESSEES OR CONTRACTORS – COMPLETED OPERATIONS

This endorsement modifies insurance provided under the following:

SCHEDULE

Name Of Additional Insured Person(s) Or Organization(s)	Location And Description Of Completed Operations
As required by written contract.	Any Location

Information required to complete this Schedule, if not shown above, will be shown in the Declarations.

A. Section II – Who Is An Insured is amended to include as an additional insured the person(s) or organization(s) shown in the Schedule, but only with respect to liability for "bodily injury" or "property damage" caused, in whole or in part, by "your work" at the location designated and described in the Schedule of this endorsement performed for that additional insured and included in the "products-completed operations hazard".

However:

1. The insurance afforded to such additional insured only applies to the extent permitted by law; and
2. If coverage provided to the additional insured is required by a contract or agreement, the insurance afforded to such additional insured will not be broader than that which you are required by the contract or agreement to provide for such additional insured.

B. With respect to the insurance afforded to these additional insureds, the following is added to Section III – Limits Of Insurance:

If coverage provided to the additional insured is required by a contract or agreement, the most we will pay on behalf of the additional insured is the amount of insurance:

1. Required by the contract or agreement; or
2. Available under the applicable Limits of Insurance shown in the Declarations; whichever is less.

This endorsement shall not increase the applicable Limits of Insurance shown in the Declarations.

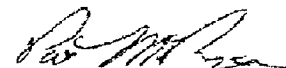

THIS ENDORSEMENT CHANGES THE POLICY. PLEASE READ IT CAREFULLY.

**ADDITIONAL INSURED – OWNERS, LESSEES OR
CONTRACTORS – SCHEDULED PERSON OR
ORGANIZATION**

This endorsement modifies insurance provided under the following:

SCHEDULE

Name Of Additional Insured Person(s) Or Organization(s)	Location(s) Of Covered Operations
As required by written contract.	Any Location
Information required to complete this Schedule, if not shown above, will be shown in the Declarations.	

- A. Section II – Who Is An Insured** is amended to include as an additional insured the person(s) or organization(s) shown in the Schedule, but only with respect to liability for "bodily injury", "property damage" or "personal and advertising injury" caused, in whole or in part, by:
1. Your acts or omissions; or
 2. The acts or omissions of those acting on your behalf;
- in the performance of your ongoing operations for the additional insured(s) at the location(s) designated above.
- However:
1. The insurance afforded to such additional insured only applies to the extent permitted by law; and
 2. If coverage provided to the additional insured is required by a contract or agreement, the insurance afforded to such additional insured will not be broader than that which you are required by the contract or agreement to provide for such additional insured.
- B.** With respect to the insurance afforded to these additional insureds, the following additional exclusions apply:
- This insurance does not apply to "bodily injury" or "property damage" occurring after:
1. All work, including materials, parts or equipment furnished in connection with such work, on the project (other than service, maintenance or repairs) to be performed by or on behalf of the additional insured(s) at the location of the covered operations has been completed; or
 2. That portion of "your work" out of which the injury or damage arises has been put to its intended use by any person or organization other than another contractor or subcontractor engaged in performing operations for a principal as a part of the same project.
- C.** With respect to the insurance afforded to these additional insureds, the following is added to **Section III – Limits Of Insurance**:

If coverage provided to the additional insured is required by a contract or agreement, the most we will pay on behalf of the additional insured is the amount of insurance:

1. Required by the contract or agreement; or
 2. Available under the applicable Limits of Insurance shown in the Declarations;
- whichever is less.

This endorsement shall not increase the applicable Limits of Insurance shown in the Declarations.

A handwritten signature in black ink, appearing to be "De M. H. 2000", located in the bottom right corner of the page.

THIS ENDORSEMENT CHANGES THE POLICY. PLEASE READ IT CAREFULLY.

**WAIVER OF TRANSFER OF RIGHTS OF RECOVERY
AGAINST OTHERS TO US**

This endorsement modifies insurance provided under the following:

SCHEDULE

Name Of Person Or Organization:

As required by written contract.

Information required to complete this Schedule, if not shown above, will be shown in the Declarations.

The following is added to Paragraph 8. **Transfer Of Rights Of Recovery Against Others To Us** of **Section IV – Conditions**:

We waive any right of recovery we may have against the person or organization shown in the Schedule above because of payments we make for injury or damage arising out of your ongoing operations or "your work" done under a contract with that person or organization and included in the "products-completed operations hazard". This waiver applies only to the person or organization shown in the Schedule above.



Policy Number: WPP1556836 00

COMMERCIAL AUTO
CA990187 0715

This Endorsement Changes The Policy. Please Read It Carefully

BUSINESS AUTO COVERAGE EXPANSION ENDORSEMENT

This endorsement modifies insurance provided by the following:

BUSINESS AUTO COVERAGE FORM

With respect to coverage provided by this endorsement, the provisions of the COVERAGE FORM apply unless modified by the endorsement.

A. Newly Acquired or Formed Organizations, Employee Hired Car Liability and Blanket Additional Insured Status for Certain Entities.

Item 1. Who is an Insured of Paragraph A. Coverage under SECTION II – COVERED AUTOS LIABILITY COVERAGE is amended to add:

- d. Any organization you newly acquire or form, other than a partnership, joint venture or limited liability company, and over which you maintain ownership of a majority interest (greater than 50%), will qualify as a Named Insured; however,
 - (1) coverage under this provision is afforded only until the 180th day after you acquire or form the organization or the end of the policy period, whichever is earlier;
 - (2) coverage does not apply to "bodily injury", "property damage" or "covered pollution cost or expense" that results from an "accident" which occurred before you acquired or formed the organization; and
 - (3) coverage does not apply if there is other similar insurance available to that organization, or if similar insurance would have been available but for its termination or the exhaustion of its limits of insurance.

This insurance does not apply if coverage for the newly acquired or formed organization is excluded either by the provisions of this coverage form or by endorsement.

- e. An "employee" of yours is an "insured" while operating an "auto" hired or rented under a contract or agreement in that "employee's" name, with your permission, while performing duties related to the conduct of your business.

- f. Any person or organization you are required by written contract or agreement to name as an additional "insured", but only with respect to liability created in whole or in part by such agreement.

B. Increase Of Loss Earnings Payment

Subpart (4) of a. Supplementary Payments of Item 2. Coverage Extensions of Paragraph A. Coverage under SECTION II – COVERED AUTOS LIABILITY COVERAGE is amended to read:

- (4) We will pay reasonable expenses incurred by the "insured" at our request, including actual loss of earnings up to \$1,000 per day because of time off from work.

C. Fellow Employee Injured By Covered Auto You Own Or Hire

Item 5. Fellow Employee of Paragraph B. Exclusions under SECTION II – COVERED AUTOS LIABILITY COVERAGE is amended to add:

This exclusion does not apply if the "bodily injury" results from the use of a covered "auto" you own or hire. Such coverage as is afforded by this provision is excess over any other collectible insurance.



D. Limited Automatic Towing Coverage

Item 2. Towing, of Paragraph A. Coverage, under SECTION III - PHYSICAL DAMAGE COVERAGE is amended to read:

2. Towing

We will pay for towing and labor costs each time that a covered "auto" is disabled. All labor must be performed at the place of disablement of the covered "auto".

- a. The limit for towing and labor for each disablement is \$500;
- b. No deductible applies to this coverage.

E. Item 3. Glass Breakage - Hitting A Bird Or Animal - Falling Objects or Missiles of Paragraph A. Coverage under SECTION III - PHYSICAL DAMAGE COVERAGE, is amended to add:

Glass Repair Coverage

We will waive the Comprehensive deductible for Glass, if one is indicated on your covered "auto", for glass repairs. We will repair at no cost to you, any glass that can be repaired without replacement, provided the "loss" arises from a covered Comprehensive "loss" to your "auto".

F. Increase Of Transportation Expense Coverage

Subpart a. Transportation Expenses of Item 4. Coverage Extensions of Paragraph A. Coverage under SECTION III - PHYSICAL DAMAGE COVERAGE is amended to read:

a. Transportation Expenses

We will pay up to \$50 per day to a maximum of \$1,000 for temporary transportation expense incurred by you because of the total theft of a covered "auto" of the private passenger type. We will pay only for those covered "autos" for which you carry either Comprehensive or Specified Causes of Loss Coverage or Theft Coverage. We will pay for temporary transportation expenses incurred during the period beginning 48 hours after the theft and ending, regardless of the policy's expiration, when the covered "auto" is returned to use or we pay for its "loss".

G. "Personal Effects" Coverage

Item 4. Coverage Extensions of Paragraph A. Coverage, under SECTION III - PHYSICAL DAMAGE COVERAGE, is amended to add:

"Personal Effects" Coverage

We will pay actual cash value for "loss" to "personal effects" of the "insured" while in a covered "auto" subject to a maximum limit of \$2,500 per "loss", for that covered "auto" caused by the same "accident". No deductible will apply to this coverage.

H. "Downtime Loss" Coverage

Item 4. Coverage Extensions, of Paragraph A. Coverage, under SECTION III. PHYSICAL DAMAGE COVERAGE, is amended to add:

"Downtime Loss" Coverage

We will pay any resulting "downtime loss" expenses you sustain as a result of a covered physical damage "loss" to a covered "auto" up to a maximum of \$100 per day, for a maximum of 30 days for the same physical damage "loss", subject to the following conditions:

- a. We will provide "downtime loss" beginning on the 5th day after we have given you our agreement to pay for repairs to a covered "auto" and you have given the repair facility your authorization to make repairs;
- b. Coverage for "downtime loss" expenses will end when any of the following occur:
 - (1) You have a spare or reserve "auto" available to you to continue your operations.
 - (2) You purchase a replacement "auto".
 - (3) Repairs to your covered "auto" have been completed by the repair facility and they determine the covered "auto" is road-worthy.
 - (4) You reach the 30 day maximum coverage.

L. Item 4. Coverage Extensions, of Paragraph A. Coverage, under SECTION III. PHYSICAL DAMAGE COVERAGE, is amended to add:

We will pay any resulting rental reimbursement expenses incurred by you for a rental of an "auto" because of "loss" to a covered "auto" up to a maximum of \$100 per day, for a maximum of 30 days for the same physical damage "loss", subject to the following conditions:

- a. We will provide rental reimbursement incurred during the policy period beginning 24 hours after the "loss" and ending, regardless of the policy expiration, with the number of days reasonably required to repair or replace the covered "auto". If the "loss" is caused by theft, this number of days is the number of days it takes to locate the covered "auto" and return it to you or the number of days it takes for the claim to be settled, whichever comes first.
- b. Our payment is limited to necessary and actual expenses incurred.
- c. This coverage does not apply while there are spare or reserve "autos" available to you for your operations.
- d. If a "loss" results from the total theft of a covered "auto" of the private passenger type, we will pay under this coverage only that amount of your rental reimbursement expenses which is not already provided for under the Physical Damage Coverage Extension.

J. "Personal Effects" Exclusion

Paragraph B. Exclusions under SECTION III - PHYSICAL DAMAGE COVERAGE, is amended to add:

"Personal Effects" Exclusion

We will not pay for "loss" to "personal effects" of any of the following:

- a. Accounts, bills, currency, deeds, evidence of debt, money, notes, securities or commercial paper or other documents of value.
- b. Bullion, gold, silver, platinum, or other precious alloys or metals; furs or fur garments; jewelry; watches; precious or semi-precious stones.
- c. Paintings, statuary and other works of art.

- d. Contraband or property in the course of illegal transportation or trade.
- e. "Loss" caused by theft, unless there is evidence of forced entry into the covered "auto" and a police report is filed.

K. Accidental Airbag Discharge Coverage

Item 3.a. of Paragraph B. Exclusions under SECTION III - PHYSICAL DAMAGE COVERAGE is amended to read:

- a. Wear and tear, freezing, mechanical or electrical breakdown. The exclusion relating to mechanical break-down does not apply to the accidental discharge of an air bag.

L. Loan or Lease Gap Coverage

Paragraph C. Limit Of Insurance under SECTION III - PHYSICAL DAMAGE COVERAGE is amended to add:

If a covered "auto" is owned or leased and if we provide Physical Damage Coverage on it, we will pay, in the event of a covered total "loss", any unpaid amount due on the lease or loan for a covered "auto", less:

- a. The amount paid under the Physical Damage Coverage Section of the policy; and
- b. Any:
 - (1) Overdue lease or loan payments including penalties, interest or other charges resulting from overdue payments at the time of the "loss";
 - (2) Financial penalties imposed under a lease for excessive use, abnormal wear and tear or high mileage;
 - (3) Costs for extended warranties, Credit Life Insurance, Health, Accident or Disability Insurance purchased with the loan or lease;
 - (4) Security deposits not refunded by the lessor; and
 - (5) Carry-over balances from previous loans or leases



M. Aggregate Deductible

Paragraph D. Deductible under SECTION III – PHYSICAL DAMAGE COVERAGE is amended to add:

Regardless of the number of covered "autos" involved in the same "loss", only one deductible will apply to that "loss". If the deductible amounts vary by "autos", then only the highest applicable deductible will apply to that "loss".

N. Diminishing Deductible

Paragraph D. Deductible under SECTION III – PHYSICAL DAMAGE COVERAGE is amended to add:

Any deductible will be reduced by the percentage indicated below on the first "loss" reported during the corresponding policy period:

Loss Free Policy Periods With the Expansion Endorsement	Deductible Reduction on the first "loss"
1	0%
2	25%
3	50%
4	75%
5	100%

If we pay a Physical Damage "loss" during the policy period under any BUSINESS AUTO COVERAGE FORM you have with us, your deductible stated in the Declarations page of each such COVERAGE FORM will not be reduced on any subsequent claims during the remainder of your policy period and your deductible reduction will revert back to 0% for each such COVERAGE FORM if coverage is renewed.

O. Knowledge of Loss and Notice To Us

Subsection a. of Item 2. Duties in the Event of Accident, Claim, Suit or Loss of Paragraph A. Loss Conditions under SECTION IV – BUSINESS AUTO CONDITIONS is amended to add:

However, prompt notice of the "accident", claim, "suit" or "loss" to us or our authorized representative only applies after the "accident", claim, "suit" or "loss" is known to:

- (1) You, if you are an individual;
- (2) A partner, if you are a partnership;

- (3) An "executive officer" or director, if you are a corporation;
- (4) A manager or member, if you are a limited liability company;
- (5) Your insurance manager; or
- (6) Your legal representative.

P. Waiver Of Subrogation For Auto Liability Losses Assumed Under Insured Contract

Item 5. Transfer Of Rights Of Recovery Against Others To Us of Paragraph A. Loss Conditions under SECTION IV – BUSINESS AUTO CONDITIONS is amended to read:

5. Transfer of Rights of Recovery Against Others To Us

If any person or organization to or for whom we make payments under this Coverage Form has rights to recover damages from another, those rights are transferred to us. That person or organization must do everything necessary to secure our rights and must do nothing after an "accident" or "loss" to impair them. However, if the insured has waived those rights to recover through a written contract, we will waive any right to recovery we may have under this Coverage Form.

Q. Insurance Is Primary and Noncontributory

Subpart a. of Item 5. Other Insurance of Paragraph B. General Conditions under SECTION IV – BUSINESS AUTO CONDITIONS is amended to read:

- a. This insurance is primary and noncontributory, as respects any other insurance, if required in a written contract with you.

R. Other Insurance – Hired Auto Physical Damage

Subpart b. of Item 5. Other Insurance of Paragraph B. General Conditions under SECTION IV – BUSINESS AUTO CONDITIONS is amended to read:

- b. For Hired Auto Physical Damage Coverage, the following are deemed to be covered "autos" you own:

- (1) Any covered "auto" you lease, hire, rent or borrow; and

- (2) Any covered "auto" hired or rented by your "employee" under a contract in that individual "employee's" name, with your permission, while performing duties related to the conduct of your business.

However, any "auto" that is leased, hired, rented or borrowed with a driver is not a covered "auto".

S. Unintentional Failure To Disclose Hazards

Paragraph B. **General Conditions** under **SECTION IV – BUSINESS AUTO CONDITIONS** is amended to add:

- 9. Your failure to disclose all hazards existing as of the inception date of this policy shall not prejudice the coverage afforded by this policy, provided that such failure to disclose all hazards is not intentional. However, you must report such previously undisclosed hazards to us as soon as practicable after its discovery.

T. Additional Definition

SECTION V – DEFINITIONS is amended to add:

"Personal effects" means personal property owned by the "insured".

"Downtime loss" means actual loss of "business income" for the period of time that a covered "auto":

- 1. Is out of service for repair or replacement as a result of a covered physical damage "loss" and
- 2. Is in the custody of a repair facility if not a total "loss".

"Business Income" means:

- 1. Net Income (Net Profit or Loss before income taxes) that would have been earned or incurred; and
- 2. Continuing normal operating expenses incurred, including payroll.

In this endorsement, Headings and Titles are inserted solely for the convenience and ease of reference. They do not affect the coverage provided by this endorsement, nor do they constitute any part of the terms and conditions of this endorsement. All other policy wording not specifically changed, modified, or replaced by this endorsement wording remains in effect.

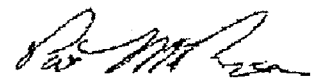

WAIVER OF OUR RIGHT TO RECOVER FROM OTHERS ENDORSEMENT

We have the right to recover our payments from anyone liable for an injury covered by this policy. We will not enforce our right against the person or organization named in the Schedule. (This agreement applies only to the extent that you perform work under a written contract that requires you to obtain this agreement from us.)

This agreement shall not operate directly or indirectly to benefit anyone not named in the Schedule.

Schedule

Where required by written contract

This endorsement changes the policy to which it is attached and is effective on the date issued unless otherwise stated.
(The information below is required only when this endorsement is issued subsequent to preparation of the policy.)

Policy Effective **01/01/2018**

Endorsement Effective **01/01/2018**

Policy No. **WD001486**

Endorsement No.

Insured

PERSONNEL STAFFING GROUP, LLC DBA KBS STAFFING

Premium \$

Insurance Company **Protective Insurance Company**

Countersigned By

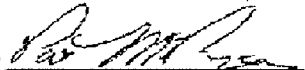

SCHEDULE OF UNDERLYING INSURANCE

Issued to: CT&T, INC.

Policy Number: EBU 051521406

By: NATIONAL UNION FIRE INSURANCE COMPANY OF PITTSBURGH, PA.

<u>TYPE OF POLICY OR COVERAGE</u>	<u>INSURER, POLICY NO. AND POLICY PERIOD</u>	<u>LIMITS</u>
GENERAL LIABILITY	Gemini Insurance Company 06/09/18 06/09/19	\$1,000,000 PER OCCURRENCE \$2,000,000 GENERAL AGGREGATE \$2,000,000 PRODUCTS & COMPLETED OPS. AGGREGATE \$2,000,000 PER PROJECT GENERAL AGGREGATE \$5,000,000 AGGREGATE POLICY CAP Defense Expenses are in addition to the limit
AUTO LIABILITY	Wesco Insurance Company 06/23/17 06/23/18	\$1,000,000 COMBINED SINGLE LIMIT Defense Expenses are in addition to the limit



AUTHORIZED REPRESENTATIVE

Endurance American Specialty Insurance Company (Delaware) (Name changed from Traders & Pacific Insurance Company effective 06/08/2006)	02/23/1996
Energy Insurance Mutual Limited (Barbados)	12/17/1997
Evanston Insurance Company (Illinois)	08/11/1995
Everest Indemnity Insurance Company (Delaware)	08/14/1998
Executive Risk Specialty Insurance Company (Connecticut)	09/01/1995
Fair American Select Insurance Company (Delaware)	07/28/2014
First Mercury Insurance Company (Delaware) (Domicile changed from Illinois to Delaware, effective 10/28/2015)	10/16/1997
First Specialty Insurance Corporation (Missouri)	09/01/1995
→ Gemini Insurance Company (Delaware)	02/23/1998
General Security Indemnity Company of Arizona (Arizona) (Name changed from Fulcrum Insurance Company effective 05/03/2002)	09/01/1995
General Star Indemnity Company (Delaware) (Domicile changed from Connecticut to Delaware, effective 12/31/2012)	08/11/1995
Gotham Insurance Company (New York)	08/04/1995
Great American E&S Insurance Company (Delaware) (Name changed from Agricultural Excess and Surplus Insurance Company, effective 07/27/2000)	06/30/1995
Great American Fidelity Insurance Company (Delaware) (Name changed from American Dynasty Surplus Lines Insurance Company, effective 06/27/2001)	09/01/1995
Great Lakes Insurance SE (Germany) (Domicile changed from UK to Germany and name changed from Great Lakes Reinsurance (UK) SE effective December 30, 2016 (Name changed from Great Lakes Reinsurance (UK) PLC (U.K.) effective 07/28/2015)	12/01/1995
GuideOne National Insurance Company (Iowa)	12/07/2015
Gulf Underwriters Insurance Company (Connecticut) (Domicile changed from Missouri to Connecticut, effective 10/01/2001)	07/07/1995

[Back to Top](#)

H - L

Insurer	Date Approved
Hallmark Specialty Insurance Company (Oklahoma)	07/01/2011
Health Care Indemnity, Inc. (Colorado)	03/21/2001
Homeland Insurance Company of New York (New York)	09/24/2003
Houston Casualty Company (Texas)	09/01/1995
Houston Specialty Insurance Company (Texas) (Name changed from Naxos Insurance Company effective 12/30/10) (Domicile changed from Delaware to Texas effective 12/30/2011)	10/08/2009
HSB Specialty Insurance Company (Connecticut)	09/26/2013



- Company Profile
- Company Search
- Company Search Results
- Company Information
- Old Company Names
- Agent for Service
- Reference Information
- NAIC Group List
- Lines of Business
- Workers' Compensation
- Complaint and Request for Action/Appeals
- Contact Information
- Financial Statements PDF's
- Annual Statements
- Quarterly Statements
- Company Complaint
- Company Performance & Comparison Data
- Company Enforcement Action
- Composite Complaints Studies
- Additional Info
- Find A Company Representative In Your Area
- View Financial Disclaimer

COMPANY PROFILE

Company Information

WESCO INSURANCE COMPANY

**59 MAIDEN LANE
NEW YORK, NY 10038
866-203-3037**

Old Company Names

Effective Date

Agent For Service

KARISSA LOWRY
2710 GATEWAY OAKS DRIVE
SUITE 150N
SACRAMENTO CA 95833

Reference Information

NAIC #:	25011
California Company ID #:	4378-6
Date Authorized in California:	09/24/1996
License Status:	UNLIMITED-NORMAL
Company Type:	Property & Casualty
State of Domicile:	DELAWARE

back to top

NAIC Group List

NAIC Group #: 2538 AmTrust NGH Grp

Lines Of Business

The company is authorized to transact business within these lines of insurance. For an explanation of any of these terms, please refer to the glossary.

- AUTOMOBILE
- BOILER AND MACHINERY
- BURGLARY
- COMMON CARRIER LIABILITY
- CREDIT
- DISABILITY
- FIRE
- LIABILITY
- MARINE
- MISCELLANEOUS
- PLATE GLASS
- SPRINKLER
- SURETY
- TEAM AND VEHICLE
- WORKERS' COMPENSATION

back to top



- Company Profile
- Company Search
- Company Search Results
- Company Information
- Old Company Names
- Agent for Service
- Reference Information
- NAIC Group List
- Lines of Business
- Workers' Compensation
- Complaint and Request for Action/Appeals
- Contact Information
- Financial Statements PDF's
- Annual Statements
- Quarterly Statements
- Company Complaint
- Company Performance & Comparison Data
- Company Enforcement Action
- Composite Complaints Studies
- Additional Info
- Find A Company Representative In Your Area
- View Financial Disclaimer

COMPANY PROFILE

Company Information

NATIONAL UNION FIRE INSURANCE COMPANY OF PITTSBURGH, PA
175 WATER STREET, 18 FLOOR
NEW YORK, NY 10038
877-399-6442

Old Company Names

Effective Date

Agent For Service

KARISSA LOWRY
 2710 GATEWAY OAKS DRIVE
 SUITE 150N
 SACRAMENTO CA 95833

Reference Information

NAIC #:	19445
California Company ID #:	0131-3
Date Authorized in California:	11/28/1902
License Status:	UNLIMITED-NORMAL
Company Type:	Property & Casualty
State of Domicile:	PENNSYLVANIA

back to top

NAIC Group List

NAIC Group #: 0012 AMERICAN INTL GRP

Lines Of Business

The company is authorized to transact business within these lines of insurance. For an explanation of any of these terms, please refer to the glossary.

- AIRCRAFT
- ✓ AUTOMOBILE
- BOILER AND MACHINERY
- BURGLARY
- COMMON CARRIER LIABILITY
- DISABILITY
- FIRE
- ✓ LIABILITY
- MARINE
- MISCELLANEOUS
- PLATE GLASS
- SPRINKLER
- ✓ SURETY
- TEAM AND VEHICLE
- ✓ WORKERS' COMPENSATION

back to top



- Company Profile
- Company Search
- Company Search Results
- Company Information
- Old Company Names
- Agent for Service
- Reference Information
- NAIC Group List
- Lines of Business
- Workers' Compensation
- Complaint and Request for Action/Appeals
- Contact Information
- Financial Statements PDF's
- Annual Statements
- Quarterly Statements
- Company Complaint
- Company Performance & Comparison Data
- Company Enforcement Action
- Composite Complaints Studies
- Additional Info
- Find A Company Representative In Your Area
- View Financial Disclaimer

COMPANY PROFILE

Company Information

PROTECTIVE INSURANCE COMPANY
111 CONGRESSIONAL BLVD., STE. 500
CARMEL, IN 46032

Old Company Names

Effective Date

Agent For Service

Vivian Imperial
 818 WEST SEVENTH STREET
 SUITE 930
 LOS ANGELES CA 90017

Reference Information

NAIC #:	12416
California Company ID #:	1689-9
Date Authorized in California:	02/08/1962
License Status:	UNLIMITED-NORMAL
Company Type:	Property & Casualty
State of Domicile:	INDIANA

back to top

NAIC Group List

NAIC Group #: 0867 Baldwin & Lyons Grp

Lines Of Business

The company is authorized to transact business within these lines of insurance. For an explanation of any of these terms, please refer to the glossary.

- AIRCRAFT
- AUTOMOBILE
- BOILER AND MACHINERY
- BURGLARY
- COMMON CARRIER LIABILITY
- CREDIT
- DISABILITY
- FIRE
- LIABILITY
- MARINE
- MISCELLANEOUS
- PLATE GLASS
- SPRINKLER
- SURETY
- TEAM AND VEHICLE
- ✓ WORKERS' COMPENSATION