

**SUBMITTAL TO THE BOARD OF SUPERVISORS
COUNTY OF RIVERSIDE, STATE OF CALIFORNIA**



ITEM
3.21
(ID # 8158)

MEETING DATE:

Tuesday, October 30, 2018

FROM : TLMA-TRANSPORTATION:

SUBJECT: TRANSPORTATION AND LAND MANAGEMENT AGENCY: TRANSPORTATION
DEPARTMENT: Accept the Low Bid and Award the Contract for the La Sierra
Avenue Resurfacing Project, in the Community of Lake Hills. 1st District;
[\$2,008,439 Total Cost]; Local Funds 100%.

RECOMMENDED MOTION: That the Board of Supervisors:

1. Approve one addendum to the plans and specifications issued prior to the August 22, 2018, bid opening; and
2. Accept the low bid of All American Asphalt of Corona, CA in the amount of \$2,008,439; and
3. Award the contract to All American Asphalt and authorize the Chairman of the Board to execute the contract documents; and
4. Approve the proposed budget as shown on Attachment 'A'.

ACTION: Policy

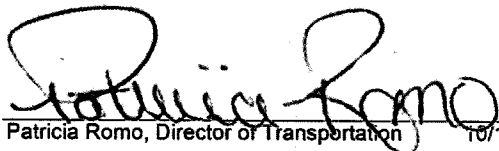
Patricia Romo, Director of Transportation 10/12/2018

MINUTES OF THE BOARD OF SUPERVISORS

On motion of Supervisor Jeffries, seconded by Supervisor Perez and duly carried by unanimous vote, IT WAS ORDERED that the above matter is approved as recommended.

Ayes: Jeffries, Tavaglione, Washington, Perez and Ashley
Nays: None
Absent: None
Date: October 30, 2018
xc: Transp.

Kecia Harper-Ihem
Clerk of the Board

By: 
Deputy

**SUBMITTAL TO THE BOARD OF SUPERVISORS COUNTY OF RIVERSIDE,
STATE OF CALIFORNIA**

FINANCIAL DATA	Current Fiscal Year:	Next Fiscal Year:	Total Cost:	Ongoing Cost
COST	\$ 2,008,439	\$ 0	\$ 2,008,439	\$ 0
NET COUNTY COST	\$ 0	\$ 0	\$ 0	\$ 0
SOURCE OF FUNDS: Gas Tax / SB-1 (98%), City of Riverside (0.3%), and Western Municipal Water District (1.66%). There are no General Funds used in this project.			Budget Adjustment: No	
			For Fiscal Year: 18/19	

C.E.O. RECOMMENDATION: Approve

BACKGROUND:

Summary

By Minute Order dated July 31, 2018 (Agenda Item 3.63), the County of Riverside (County) Board of Supervisors authorized the Clerk of the Board to advertise for the construction of the La Sierra Avenue Resurfacing Project, in the Community of Lake Hills. The project limits are El Sobrante Road to the County of Riverside/City of Riverside boundary (approximately 200-feet North of Middleborough Road), approximately 2.4 miles.

The project will remove the existing asphalt pavement and place 0.17' of rubberized hot mix asphalt pavement overlay. Sixteen existing curb ramps will be replaced with ADA compliant access ramps to comply with the ADA standards.

The improvements include installation of asphalt concrete overside drains, placement of asphalt concrete dike, asphalt concrete driveway, reconstruction of concrete driveways, curb ramps, cross-gutters, spandrels, utility adjustments, detector loops, video detection cameras at four signalized intersections, striping, thermoplastic pavement markings, construction of ground-in rumble strips along the centerline of various segments of the road to alert drivers when they stray from the lanes, and other associated work.

A portion of La Sierra Avenue is in the City of Riverside. The City portion includes the easterly half of the street, from Cleveland Avenue to the north end of this project (approximately 200-feet North of Middleborough Road). The City was invited to participate in resurfacing their half of the street, but declined.

On April 28, 2017, Senate Bill 1 (SB1) was passed to improve the state's aging transportation infrastructure, particularly roads and bridges. Because of this, the County is now able to improve the condition of roads in need of resurfacing or reconstruction and has included them in the County Transportation Improvement Program (TIP). La Sierra Avenue resurfacing is urgently needed to improve an aging road in a state of disrepair. Without SB1, this needed road repair project would have been shelved until funding became available.

**SUBMITTAL TO THE BOARD OF SUPERVISORS COUNTY OF RIVERSIDE,
STATE OF CALIFORNIA**

During the advertisement period, one addendum was issued to all registered plan holders as a supplement to the plans and specifications. Bidders were required to acknowledge and take into account issued addendum on their Contractor's Bid in order to be considered for award. The addendum was issued to clarify and modify the approved contract documents. The addendum is attached and designated as Addendum No. 1.

The County of Riverside Transportation Department (Transportation Department) recommends award of the following schedules of work in the Contract amount of \$2,008,439:

Base Bid Schedule: La Sierra Avenue Resurfacing Project
Alternate Bid Schedule 1: Western Municipal Water District (WMWD) Facilities Adjustments
Alternate Bid Schedule 2: City of Riverside Facilities Adjustments.

WMWD and the City of Riverside have concurred with the bid prices proposed by All American Asphalt for alternate bid schedules 1 and 2.

A reimbursement agreement between the County of Riverside and WMWD for utility adjustments in the amount of \$41,790.00 was executed on August 30, 2018. WMWD will be 100% responsible for the cost of the utility adjustments.

A reimbursement agreement between the County of Riverside and City of Riverside for utility adjustments in the amount of \$7,960.00 was executed on September 11, 2018. The City of Riverside will be 100% responsible for the cost of the utility adjustments.

The Director of Transportation has the authority to sign reimbursement agreements for utility adjustments up to \$50,000 per Minute Order dated February 28, 2006 (Agenda Item 3.52).

The Contractor is qualified to perform the work as outlined in the bid, has executed the contract, and has provided bonds and insurance documents, which meet the requirements of the Contract.

Project No. C6-0074

Impact on Residents and Businesses

The purpose of this project is to rehabilitate the deteriorated segment of La Sierra Avenue from El Sobrante Road to County of Riverside/City of Riverside boundary (approximately 200-feet North of Middleborough Road) to provide the public with a smooth paved roadway that will improve the safety and efficiency of vehicular traffic.

The work is scheduled to begin in Fall of 2018. The work will be phased to keep the road open during construction as much as possible and will take approximately two months to complete.

SUPPLEMENTAL:

**SUBMITTAL TO THE BOARD OF SUPERVISORS COUNTY OF RIVERSIDE,
STATE OF CALIFORNIA**

Additional Fiscal Information

The contract is recommended to be awarded to All American Asphalt for the total amount of \$2,008,439.

The project will be funded with Gas Tax/SB-1, City of Riverside and WMWD funds. There are no General Funds used in this project.

The La Sierra Resurfacing Project is expected to be completed within the proposed budget as shown on Attachment "A", which includes the contract award amount and other associated costs.

Contract History and Price Reasonableness

Four bids were received ranging from \$2,008,439 to \$2,494,650. The basis for the selection of a contractor is the lowest responsive and responsible bid.

All received bids were responsive to the bidding requirements set forth for the project. The lowest responsible bid was submitted by All American Asphalt in the amount of \$2,008,439 which is \$307,568 (13%) below the Engineer's Estimate.

ATTACHMENTS:

Vicinity Map
Attachment A
Summary of Bids
Addendum No. 1
Contract/Bonds/Insurance
Contractor's Bid Proposal

Scott Bruckner

10/22/2018

Gregory V. Priamos, Director County Counsel

10/18/2018

COUNTY OF RIVERSIDE
TRANSPORTATION DEPARTMENT

LA SIERRA AVENUE

RESURFACING
EL SOBRANTE ROAD TO
COUNTY OF RIVERSIDE/
CITY OF RIVERSIDE BOUNDARY

COMMUNITY OF LAKE HILLS

Project No. C6-0074

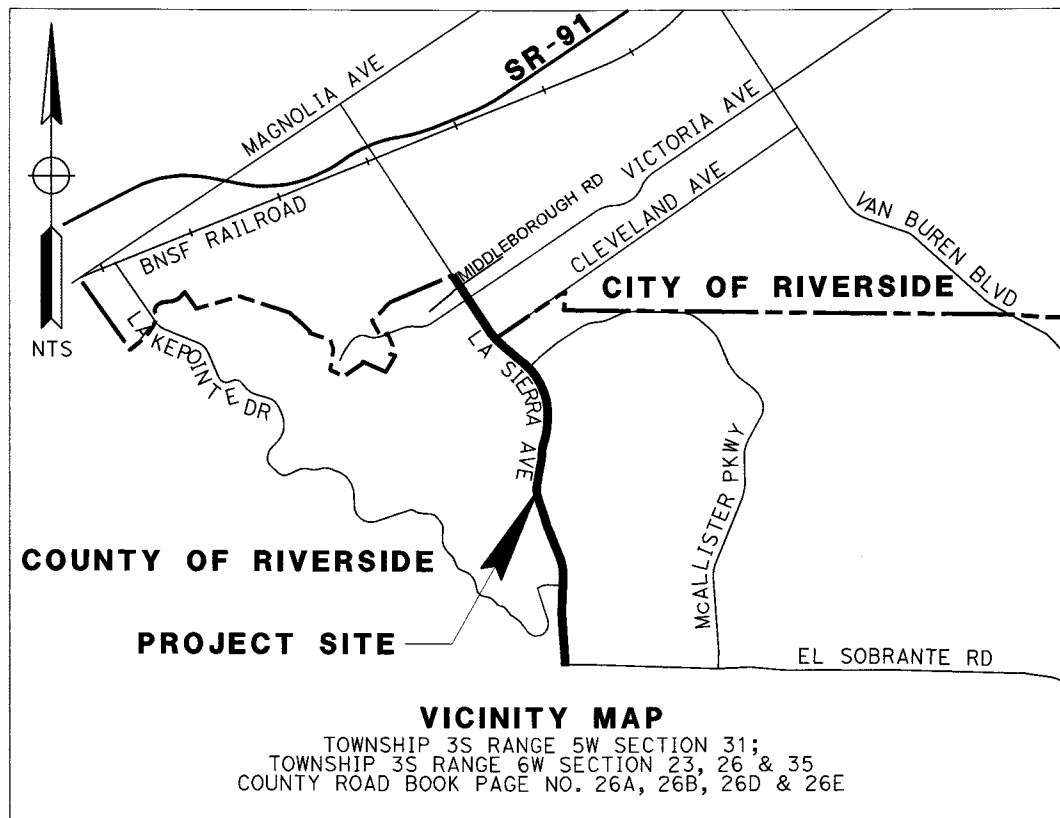
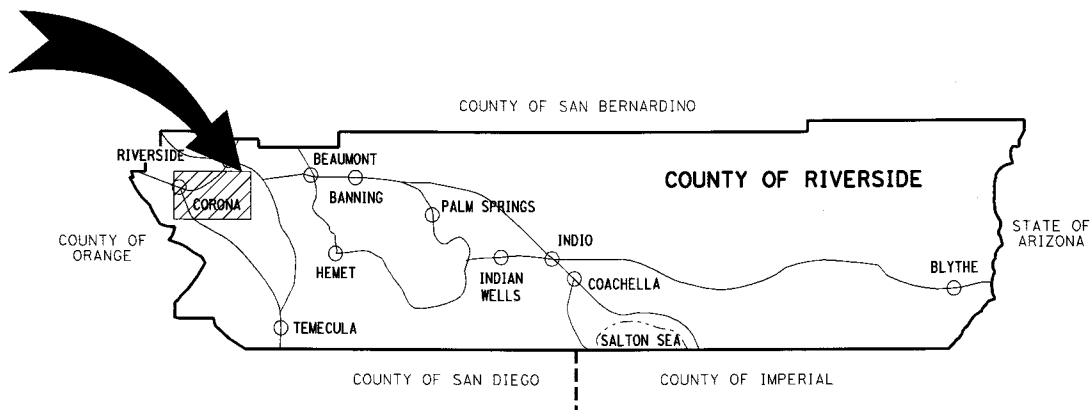

Attachment "A"

Riverside County Transportation Department

Project: **LA SIERRA**
RESURFACING: EL SOBRANTE ROAD TO CITY OF RIVERSIDE LIMIT

Project No.(s): **C6-0074**

Expenses as of: 9/26/2018

Project Costs and Budget

Activity	Incurred Costs	Projected Costs	Total Costs	Existing Budget	Proposed Budget
Preliminary Survey	394		1,000	10,000	1,000
Environmental	26		1,000	12,000	1,000
Design	153,788	15,000	169,000	140,000	169,000
Right-of-way					
Utilities					
Construction		2,008,439	2,210,000	1,240,000	2,210,000
Construction Contingency 10%		200,844			
Construction Engineering & Inspection 13%		262,000	262,000	210,000	262,000
Construction Survey 2%		40,000	40,000	35,000	40,000
Totals:	154,208	2,526,283	2,683,000	1,647,000	2,683,000

Project Funding

Code	Name	Existing Budget	Proposed Budget
223	Gas Tax/SB-1	1,647,000	2,633,000
844	Western Municipal Water District		42,000
719	City of Riverside (AT&T)		8,000
Totals		1,647,000	2,683,000

Comments

**Riverside County Transportation Department
Summary of Bids**

Advertised: July 31, 2018 (Agenda Item: 3.63)
Addenda: 1 (8/17/2018)
Bids Open: 2 pm Date: Wednesday, August 22, 2018

PROJECT: La Sierra Avenue Resurfacing Project
El Sobrante Rd to County of Riverside/City of Riverside Boundary
Community of Lake Hills
Project No. CG-0074

BASE BID SCHEDULE: La Sierra Avenue Resurfacing Project			COUNTY'S ESTIMATE			All American Asphalt Corona, CA 92878		
ITEM NO.	ITEM CODE	CONTRACT ITEM	UNITS	QUANTITY	UNIT PRICE	ENG ESTIMATE	BID UNIT PRICE	BID ESTIMATE
1	100100	DEVELOP WATER SUPPLY	LS	1	10,000.00	10,000.00	1,465.00	1,465.00
2	120100	TRAFFIC CONTROL SYSTEM	LS	1	50,000.00	50,000.00	59,400.00	59,400.00
3	130200	PREPARE WATER POLLUTION CONTROL PROGRAM	LS	1	10,000.00	10,000.00	1,250.00	1,250.00
4	170103	CLEARING AND GRUBBING (LS)	LS	1	15,000.00	15,000.00	10,500.00	10,500.00
5	066100	DUST ABATEMENT	LS	1	5,000.00	5,000.00	9,600.00	9,600.00
6	860201	SIGNAL AND LIGHTING (BLACKBURN RD)	LS	1	24,000.00	24,000.00	33,150.00	33,150.00
7	860201	SIGNAL AND LIGHTING (LAKE CREST DR)	LS	1	24,000.00	24,000.00	33,150.00	33,150.00
8	860201	SIGNAL AND LIGHTING (LAKE KNOLL PKWY)	LS	1	24,000.00	24,000.00	33,150.00	33,150.00
9	860201	SIGNAL AND LIGHTING (MCALLISTER PKWY)	LS	1	24,000.00	24,000.00	33,150.00	33,150.00
10	013902	ASPHALT CONCRETE OVERSIDE DRAIN (CRS 306)	EA	10	1,000.00	10,000.00	363.00	3,630.00
11	013903	PLACE ASPHALT CONCRETE DIKE (CRS 212) (6")	LF	13,035	10.00	130,350.00	1.70	22,159.50
12	013908	ASPHALT CONCRETE DRIVEWAY	SQFT	1,155	18.00	20,790.00	9.20	10,626.00
13	390132	HOT MIX ASPHALT (TYPE A)	TON	520	80.00	41,600.00	65.50	34,060.00
14	390137	RUBBERIZED HOT MIX ASPHALT (GAP GRADED)	TON	10,105	90.00	909,450.00	90.50	914,502.50
15	394074	PLACE HOT MIX ASPHALT DIKE (TYPE C)	LF	580	3.00	1,740.00	1.70	986.00
16	398200	COLD PLANE ASPHALT CONCRETE PAVEMENT	SCYD	88,440	3.00	265,320.00	1.95	172,458.00
17	510501	MINOR CONCRETE	CY	3	35.00	105.00	900.00	2,700.00
18	000001	ITEM DELETED PER ADDENDUM No. 1						
19	000001	ITEM DELETED PER ADDENDUM No. 1						
20	000001	ITEM DELETED PER ADDENDUM No. 1						
21	000001	ITEM DELETED PER ADDENDUM No. 1						
22	017302	MINOR CONCRETE (CROSS-GUTTER) (CRS 209)	SQFT	4,375	35.00	153,125.00	23.00	100,625.00
23	017303	MINOR CONCRETE (SPANDREL) (CRS 209)	SQFT	5,315	35.00	186,025.00	22.00	116,930.00
24	017315	MINOR CONCRETE (CURB RAMP) (CRS 403 - CASE A)	EA	15	3,500.00	52,500.00	5,100.00	76,500.00
25	017316	MINOR CONCRETE (CURB RAMP) (CRS 403 - CASE B)	EA	1	3,500.00	3,500.00	5,600.00	5,600.00
26	810230	PAVEMENT MARKER (RETROREFLECTIVE)	EA	1,702	5.00	8,510.00	4.00	6,808.00
27	820130	OBJECT MARKER	EA	25	120.00	3,000.00	57.00	1,425.00

**Riverside County Transportation Department
Summary of Bids**

PROJECT: La Sierra Avenue Resurfacing Project
EI Sobrante Rd to County of Riverside/City of Riverside Boundary
Community of Lake Hills

Project No. CG-0074

Advertised: July 31, 2018 (Agenda Item: 3.63)

Addenda: 1 (8/17/2018)

Bids Open: 2 pm Date: Wednesday, August 22, 2018

BASE BID SCHEDULE: La Sierra Avenue Resurfacing Project		COUNTY'S ESTIMATE			All American Asphalt Corona, CA 92878			
ITEM NO.	ITEM CODE	CONTRACT ITEM	UNITS	QUANTITY	UNIT PRICE	ENG ESTIMATE	BID UNIT PRICE	BID ESTIMATE
28	820410	SALVAGE ROADSIDE SIGN	EA	47	200.00	9,400.00	41.00	1,927.00
29	820840	ROADSIDE SIGN - ONE POST	EA	46	300.00	13,800.00	311.00	14,306.00
30	820850	ROADSIDE SIGN - TWO POST	EA	3	300.00	900.00	777.00	2,331.00
31	840519	THERMOPLASTIC CROSSWALK AND PAVEMENT MARKING	SOFT	2,455	3.50	8,592.50	5.20	12,766.00
32	840656	PAINT TRAFFIC STRIPE (2-COAT)	LF	65,000	0.50	32,500.00	0.46	29,900.00
33	846051	12" RUMBLE STRIP (ASPHALT CONCRETE PAVEMENT)	STA	43	200.00	8,600.00	218.00	9,374.00
34	870111	INDUCTIVE LOOP DETECTOR (EA)	EA	26	700.00	18,200.00	285.00	7,410.00
35	010602	MISCELLANEOUS WORK (AS DIRECTED)	FA	1	207,000.00	207,000.00	207,000.00	207,000.00
BASE BID SCHEDULE TOTAL						2,271,007.50		1,968,839.00
ITEMS 1 - 35								

ALTERNATE BID SCHEDULE 1: Western Municipal Water District (WMWD) Facilities Adjustments								
ITEM NO.	ITEM CODE	CONTRACT ITEM	UNITS	QUANTITY	UNIT PRICE	ENG ESTIMATE	BID UNIT PRICE	BID ESTIMATE
36	710200	ADJUST MANHOLE	EA	38	1,000.00	38,000.00	880.00	33,440.00
ALTERNATE BID SCHEDULE 1 TOTAL						38,000.00		33,440.00
ITEM 36								

ALTERNATE BID SCHEDULE 2 - City of Riverside Facilities Adjustments								
ITEM NO.	ITEM CODE	CONTRACT ITEM	UNITS	QUANTITY	UNIT PRICE	ENG ESTIMATE	BID UNIT PRICE	BID ESTIMATE
37	710200	ADJUST MANHOLE	EA	7	1,000.00	7,000.00	880.00	6,160.00
ALTERNATE BID SCHEDULE 2 TOTAL						7,000.00		6,160.00
ITEM 37								

PROJECT TOTAL		ITEMS 1 - 37	
2,316,007.50	2,316,007.50	2,008,439.00	2,008,439.00

**Riverside County Transportation Department
Summary of Bids**

**PROJECT: La Sierra Avenue Resurfacing Project
El Sobrante Rd to County of Riverside/City of Riverside Boundary
Community of Lake Hills**

Advertised: July 31, 2018 (Agenda Item: 3.63)

Addenda: 1 (8/17/2018)

Bids Open: 2 pm Date: Wednesday, August 22, 2018

Project No. C6-0074

BASE BID SCHEDULE: La Sierra Avenue Resurfacing Project		2		3		
ITEM NO.	ITEM CODE	CONTRACT ITEM	BID UNIT PRICE	BID ESTIMATE	BID UNIT PRICE	BID ESTIMATE
1	100100	DEVELOP WATER SUPPLY	10,000.00	10,000.00	11,622.00	11,622.00
2	120100	TRAFFIC CONTROL SYSTEM	50,000.00	50,000.00	222,000.00	222,000.00
3	130200	PREPARE WATER POLLUTION CONTROL PROGRAM	55,000.00	55,000.00	13,000.00	13,000.00
4	170103	CLEARING AND GRUBBING (LS)	15,000.00	15,000.00	111,000.00	111,000.00
5	066100	DUST ABATEMENT	20,000.00	20,000.00	13,000.00	13,000.00
6	860201	SIGNAL AND LIGHTING (BLACKBURN RD)	34,000.00	34,000.00	41,000.00	41,000.00
7	860201	SIGNAL AND LIGHTING (LAKE CREST DR)	34,000.00	34,000.00	41,000.00	41,000.00
8	860201	SIGNAL AND LIGHTING (LAKE KNOLL PKWY)	34,000.00	34,000.00	41,000.00	41,000.00
9	860201	SIGNAL AND LIGHTING (MCALLISTER PKWY)	34,000.00	34,000.00	41,000.00	41,000.00
10	013902	ASPHALT CONCRETE OVERSIDE DRAIN (CRS 306)	2,500.00	25,000.00	1,500.00	15,000.00
11	013903	PLACE ASPHALT CONCRETE DIKE (CRS 212) (6")	1.90	24,766.50	5.00	65,175.00
12	013908	ASPHALT CONCRETE DRIVEWAY	7.80	9,009.00	10.00	11,550.00
13	390132	HOT MIX ASPHALT (TYPE A)	115.00	59,800.00	111.00	57,720.00
14	390137	RUBBERIZED HOT MIX ASPHALT (GAP GRADED)	82.00	828,610.00	95.00	959,975.00
15	394074	PLACE HOT MIX ASPHALT DIKE (TYPE C)	1.90	1,102.00	10.00	5,800.00
16	398200	COLD PLANE ASPHALT CONCRETE PAVEMENT	2.10	185,724.00	2.00	176,880.00
17	510501	MINOR CONCRETE	885.00	2,655.00	10,000.00	30,000.00
18	000001	ITEM DELETED PER ADDENDUM No. 1				
19	000001	ITEM DELETED PER ADDENDUM No. 1				
20	000001	ITEM DELETED PER ADDENDUM No. 1				
21	000001	ITEM DELETED PER ADDENDUM No. 1				
22	017302	MINOR CONCRETE (CROSS-GUTTER) (CRS 209)	22.00	96,250.00	16.00	70,000.00
23	017303	MINOR CONCRETE (SPANDREL) (CRS 209)	19.00	100,985.00	16.00	85,040.00
24	017315	MINOR CONCRETE (CURB RAMP) (CRS 403 - CASE A)	4,150.00	62,250.00	3,900.00	58,500.00
25	017316	MINOR CONCRETE (CURB RAMP) (CRS 403 - CASE B)	4,150.00	4,150.00	3,900.00	3,900.00
26	810230	PAVEMENT MARKER (RETROREFLECTIVE)	4.00	6,808.00	4.00	6,808.00
27	820130	OBJECT MARKER	59.00	1,475.00	76.00	1,900.00

**Riverside County Transportation Department
Summary of Bids**

Advertised: July 31, 2018 (Agenda Item: 3.63)
 Addenda: 1 (8/17/2018)
 Bids Open: 2 pm Date: Wednesday, August 22, 2018

PROJECT: La Sierra Avenue Resurfacing Project
 El Sobrante Rd to County of Riverside/City of Riverside Boundary
 Community of Lake Hills
 Project No. C6-0074

ITEM NO.	ITEM CODE	CONTRACT ITEM	UNITS	QUANTITY	2		3	
					BID UNIT PRICE	BID ESTIMATE	BID UNIT PRICE	BID ESTIMATE
28	820410	SALVAGE ROADSIDE SIGN	EA	47	43.00	2,021.00	55.00	2,585.00
29	820840	ROADSIDE SIGN - ONE POST	EA	46	320.00	14,720.00	330.00	15,180.00
30	820850	ROADSIDE SIGN - TWO POST	EA	3	800.00	2,400.00	1,000.00	3,000.00
31	840519	THERMOPLASTIC CROSSWALK AND PAVEMENT MARKING	SOFT	2,455	5.25	12,888.75	6.00	14,730.00
32	840656	PAINT TRAFFIC STRIPE (2-COAT)	LF	65,000	0.50	32,500.00	0.45	29,250.00
33	846051	12" RUMBLE STRIP (ASPHALT CONCRETE PAVEMENT)	STA	43	225.00	9,675.00	300.00	12,900.00
34	870111	INDUCTIVE LOOP DETECTOR (EA)	EA	26	330.00	8,580.00	500.00	13,000.00
35	010602	MISCELLANEOUS WORK (AS DIRECTED)	FA	1	207,000.00	207,000.00	207,000.00	207,000.00
BASE BID SCHEDULE TOTAL						1,984,369.25		2,380,515.00
ITEMS 1 - 35								

ITEM NO.	ITEM CODE	CONTRACT ITEM	UNITS	QUANTITY	BID UNIT PRICE	BID ESTIMATE	BID UNIT PRICE	BID ESTIMATE
36	710200	ADJUST MANHOLE	EA	38	775.00	29,450.00	1,000.00	38,000.00
ALTERNATE BID SCHEDULE 1 TOTAL						29,450.00		38,000.00
ITEM 36								

ITEM NO.	ITEM CODE	CONTRACT ITEM	UNITS	QUANTITY	BID UNIT PRICE	BID ESTIMATE	BID UNIT PRICE	BID ESTIMATE
37	710200	ADJUST MANHOLE	EA	7	775.00	5,425.00	1,000.00	7,000.00
ALTERNATE BID SCHEDULE 2 TOTAL						5,425.00		7,000.00
ITEM 37								

ALTERNATE BID SCHEDULE 2 - City of Riverside Facilities Adjustments								
ITEM NO.	ITEM CODE	CONTRACT ITEM	UNITS	QUANTITY	BID UNIT PRICE	BID ESTIMATE	BID UNIT PRICE	BID ESTIMATE
PROJECT TOTAL						2,019,244.25		2,425,515.00
ITEMS 1 - 37								

**Riverside County Transportation Department
Summary of Bids**

**PROJECT: La Sierra Avenue Resurfacing Project
El Sobrante Rd to County of Riverside/City of Riverside Boundary
Community of Lake Hills**

Advertised: July 31, 2018 (Agenda Item: 3.63)
Addenda: 1 (8/17/2018)
Bids Open: 2 pm Date: Wednesday, August 22, 2018

Project No. C6-0074

BASE BID SCHEDULE: La Sierra Avenue Resurfacing Project

4
Vance Corporation
Bloomington, CA 92316

ITEM NO.	ITEM CODE	CONTRACT ITEM	UNITS	QUANTITY	BID UNIT PRICE	BID ESTIMATE		
1	100100	DEVELOP WATER SUPPLY	LS	1	10,000.00	10,000.00		
2	120100	TRAFFIC CONTROL SYSTEM	LS	1	250,000.00	250,000.00		
3	130200	PREPARE WATER POLLUTION CONTROL PROGRAM	LS	1	30,000.00	30,000.00		
4	170103	CLEARING AND GRUBBING (LS)	LS	1	15,000.00	15,000.00		
5	066100	DUST ABATEMENT	LS	1	30,000.00	30,000.00		
6	860201	SIGNAL AND LIGHTING (BLACKBURN RD)	LS	1	35,000.00	35,000.00		
7	860201	SIGNAL AND LIGHTING (LAKE CREST DR)	LS	1	35,000.00	35,000.00		
8	860201	SIGNAL AND LIGHTING (LAKE KNOLL PKWY)	LS	1	35,000.00	35,000.00		
9	860201	SIGNAL AND LIGHTING (MCALLISTER PKWY)	LS	1	35,000.00	35,000.00		
10	013902	ASPHALT CONCRETE OVERSIDE DRAIN (CRS 306)	EA	10	1,000.00	10,000.00		
11	013903	PLACE ASPHALT CONCRETE DIKE (CRS 212) (6")	LF	13,035	3.00	39,105.00		
12	013908	ASPHALT CONCRETE DRIVEWAY	SQFT	1,155	10.00	11,550.00		
13	390132	HOT MIX ASPHALT (TYPE A)	TON	520	75.00	39,000.00		
14	390137	RUBBERIZED HOT MIX ASPHALT (GAP GRADED)	TON	10,105	93.00	939,765.00		
15	394074	PLACE HOT MIX ASPHALT DIKE (TYPE C)	LF	580	3.00	1,740.00		
16	398200	COLD PLANE ASPHALT CONCRETE PAVEMENT	SQYD	88,440	3.80	336,072.00		
17	510501	MINOR CONCRETE	CY	3	2,750.00	8,250.00		
18	000001	ITEM DELETED PER ADDENDUM No. 1						
19	000001	ITEM DELETED PER ADDENDUM No. 1						
20	000001	ITEM DELETED PER ADDENDUM No. 1						
21	000001	ITEM DELETED PER ADDENDUM No. 1						
22	017302	MINOR CONCRETE (CROSS-GUTTER) (CRS 209)	SQFT	4,375	20.00	87,500.00		
23	017303	MINOR CONCRETE (SPANDREL) (CRS 209)	SQFT	5,315	22.00	116,930.00		
24	017315	MINOR CONCRETE (CURB RAMP) (CRS 403 - CASE A)	EA	15	6,000.00	90,000.00		
25	017316	MINOR CONCRETE (CURB RAMP) (CRS 403 - CASE B)	EA	1	6,000.00	6,000.00		
26	810230	PAVEMENT MARKER (RETROREFLECTIVE)	EA	1,702	4.00	6,808.00		
27	820130	OBJECT MARKER	EA	25	75.00	1,875.00		

**Riverside County Transportation Department
Summary of Bids**

PROJECT: La Sierra Avenue Resurfacing Project
El Sobrante Rd to County of Riverside/City of Riverside Boundary
Community of Lake Hills

Advertised: July 31, 2018 (Agenda Item: 3.63)
Addenda: 1 (8/17/2018)
Bids Open: 2 pm Date: Wednesday, August 22, 2018

Project No. C6-0074

BASE BID SCHEDULE: La Sierra Avenue Resurfacing Project

ITEM NO.	ITEM CODE	CONTRACT ITEM	UNITS	QUANTITY	BID UNIT PRICE	BID ESTIMATE	
28	820410	SALVAGE ROADSIDE SIGN	EA	47	75.00	3,525.00	
29	820840	ROADSIDE SIGN - ONE POST	EA	46	350.00	16,100.00	
30	820850	ROADSIDE SIGN - TWO POST	EA	3	800.00	2,400.00	
31	840519	THERMOPLASTIC CROSSWALK AND PAVEMENT MARKING	SQFT	2,455	6.00	14,730.00	
32	840656	PAINT TRAFFIC STRIPE (2-COAT)	LF	65,000	0.50	32,500.00	
33	846051	12" RUMBLE STRIP (ASPHALT CONCRETE PAVEMENT)	STA	43	400.00	17,200.00	
34	870111	INDUCTIVE LOOP DETECTOR (EA)	EA	26	350.00	9,100.00	
35	010602	MISCELLANEOUS WORK (AS DIRECTED)	FA	1	207,000.00	207,000.00	
BASE BID SCHEDULE TOTAL						2,472,150.00	
ITEMS 1 - 35							

Vance Corporation
Bloomington, CA 92316

ALTERNATE BID SCHEDULE 1: Western Municipal Water District (WMWD) Facilities Adjustments

ITEM NO.	ITEM CODE	CONTRACT ITEM	UNITS	QUANTITY	BID UNIT PRICE	BID ESTIMATE	
36	710200	ADJUST MANHOLE	EA	38	500.00	19,000.00	
ALTERNATE BID SCHEDULE 1 TOTAL						19,000.00	
ITEM 36							

ALTERNATE BID SCHEDULE 2 - City of Riverside Facilities Adjustments

ITEM NO.	ITEM CODE	CONTRACT ITEM	UNITS	QUANTITY	BID UNIT PRICE	BID ESTIMATE	
37	710200	ADJUST MANHOLE	EA	7	500.00	3,500.00	
ALTERNATE BID SCHEDULE 2 TOTAL						3,500.00	
ITEM 37							

PROJECT TOTAL						2,494,650.00	
ITEMS 1 - 37							



Patricia Romo, P.E.
Director of Transportation

COUNTY OF RIVERSIDE

TRANSPORTATION AND LAND MANAGEMENT AGENCY

Mojahed Salama, P.E.
Deputy for Transportation/Capital Projects
Richard Lantis, P.L.S.
Deputy for Transportation/Planning and
Development

Transportation Department

ADDENDUM NUMBER 1

Dated August 17, 2018

to the
Specifications and Contract Documents
for the construction of

La Sierra Avenue Resurfacing Project
El Sobrante Road to County of Riverside/City of Riverside Boundary
Community of Lake Hills
Project No. C6-0074

Bids Due: Wednesday, August 22, 2018; 2:00 p.m.
14th Street Transportation Annex
3525 14th Street; Riverside, CA 92501
(951) 955-6780

This Addendum is issued pursuant to the Instructions to Bidders, Item No. 8, of the Contract Documents for the reference project. This Addendum is issued as a supplement to the specification and special provisions for the referenced project. The revisions to the specifications shall become a part of the Contract Documents, and each bidder shall acknowledge receipt thereof on the Bid (Proposal). Bidders are directed to sign this addendum as acknowledged and attach the signed addendum to the contractor's submitted proposal.

Note: During the advertisement period of this project, this document and attachments (if any) are available upon request at the office of the Transportation Department, and are available as a free download at the Transportation Department's website:

<http://rctlma.org/trans/Contractors-Corner/Notices-Inviting-Bids>

MODIFICATIONS / CLARIFICATIONS TO SPECIAL PROVISIONS:

Item 1: Revised Proposal. Refer to "Proposal" pages B2 and B3. Delete and replace "Proposal" (pages B2 and B3) with "Proposal (Revised)" attached herewith as **Attachment "A"**.

- a. "Estimated Quantities" are revised from the following bid items:
 - Item 14, "RUBBERIZED HOT MIX ASPHALT (GAP GRADED)"
 - Item 16, "COLD PLANE ASPHALT CONCRETE PAVEMENT"
 - Item 36, "ADJUST MANHOLE"

- b. Alternative Bid Item No. 2 has been replaced by City of Riverside Manholes Adjustments:
Item 37 "ADJUST MANHOLE"

- c. Items 18 through 21 have been deleted.

MODIFICATIONS / CLARIFICATIONS TO THE PLANS

Item 2: Plan sheet revisions. The following Plan sheets are revised by **Attachment "B"** and made a part hereby:

Delete and replace the following eight (8) plan sheets:

1. Plan sheet 10 of 20, L-7
2. Plan sheet 11 of 20, L-8
3. Plan sheet 13 of 20, PD-1
4. Plan sheet 14 of 20, PD-2
5. Plan sheet 15 of 20, PD-3
6. Plan sheet 16 of 20, PD-4
7. Plan sheet 17 of 20, PD-5
8. Plan sheet 18 of 20, PD-6

Note: All revised plan sheets are posted on the County website and are available for download during the advertisement period.

<http://rctlma.org/trans/Contractors-Corner/Notices-Inviting-Bids>

ATTACHMENTS

- A – Revised Proposal**

- B – Revised Plan Sheets (8)**

This addendum has been prepared under the direction of the following registered Civil Engineer(s):

Recommended by:

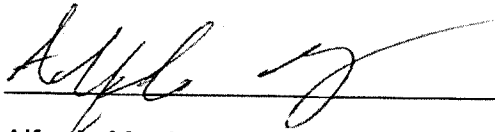
 8/17/18

Alfredo Martinez, PE
County Project Manager

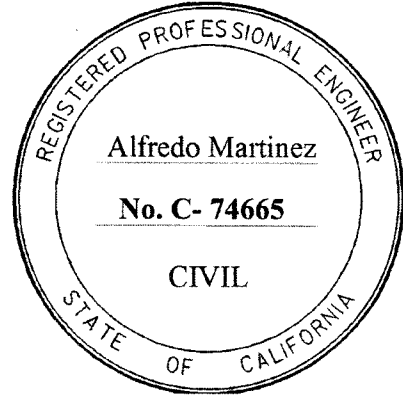

Concurrence:

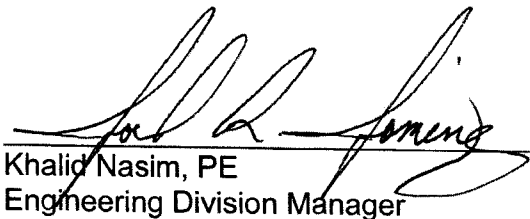
 for 8/17/18

Khalid Nasim, PE
Engineering Division Manager

Acknowledged: _____ **Date:** _____
(Contractor)

JRJ:rrj:rr

Note: Refer to Instruction to Bidders Item No. 8, "Addenda". Submission of all addendum pages and non-bidding document attachments of addendum are not necessary for Bid submittal. Submittal of this acknowledgement page is adequate for Bid reception. Bidders are reminded to list addendum number(s) received on the first page of the Bid form (Proposal).

**La Sierra Avenue Resurfacing Project
El Sobrante Road to County of Riverside/City of Riverside Boundary
Community of Lake Hills
Project No. C6-0074**

REVISED PROPOSAL

ITEM No.	ITEM CODE	ITEM	UNIT	ESTIMATED QUANTITY	ITEM PRICE (IN FIGURES)	TOTAL (IN FIGURES)
BASE BID SCHEDULE: La Sierra Avenue Resurfacing Project						
1	100100	DEVELOP WATER SUPPLY	LS	1		
2	120100	TRAFFIC CONTROL SYSTEM	LS	1		
3	130200	PREPARE WATER POLLUTION CONTROL PROGRAM	LS	1		
4	170103	CLEARING AND GRUBBING (LS)	LS	1		
5	066100	DUST ABATEMENT	LS	1		
6	860201	SIGNAL AND LIGHTING (BLACKBURN RD)	LS	1		
7	860201	SIGNAL AND LIGHTING (LAKE CREST DR)	LS	1		
8	860201	SIGNAL AND LIGHTING (LAKE KNOLL PKWY)	LS	1		
9	860201	SIGNAL AND LIGHTING (MCALLISTER PKWY)	LS	1		
10	013902	ASPHALT CONCRETE OVERSIDE DRAIN (CRS 306)	EA	10		
11	013903	PLACE ASPHALT CONCRETE DIKE (CRS 212) (6")	LF	13,035		
12	013908	ASPHALT CONCRETE DRIVEWAY	SQFT	1,155		
13	390132	HOT MIX ASPHALT (TYPE A)	TON	520		
14	390137	RUBBERIZED HOT MIX ASPHALT (GAP GRADED)	TON	10,105		
15	394074	PLACE HOT MIX ASPHALT DIKE (TYPE C)	LF	580		
16	398200	COLD PLANE ASPHALT CONCRETE PAVEMENT	SQYD	88,440		
17	510501	MINOR CONCRETE	CY	3		
18	000001	ITEM DELETED PER ADDENDUM No. 1	-----	-----	-----	-----
19	000001	ITEM DELETED PER ADDENDUM No. 1	-----	-----	-----	-----
20	000001	ITEM DELETED PER ADDENDUM No. 1	-----	-----	-----	-----
21	000001	ITEM DELETED PER ADDENDUM No. 1	-----	-----	-----	-----
22	017302	MINOR CONCRETE (CROSS-GUTTER) (CRS 209)	SQFT	4,375		
23	017303	MINOR CONCRETE (SPANDREL) (CRS 209)	SQFT	5,315		
24	017315	MINOR CONCRETE (CURB RAMP) (CRS 403 - CASE A)	EA	15		
25	017316	MINOR CONCRETE (CURB RAMP) (CRS 403 - CASE B)	EA	1		
26	810230	PAVEMENT MARKER (RETROREFLECTIVE)	EA	1,702		
27	820130	OBJECT MARKER	EA	25		

Addendum No. 1, Page 4 of 13

REVISED PROPOSAL

ITEM No.	ITEM CODE	ITEM	UNIT	ESTIMATED QUANTITY	ITEM PRICE (IN FIGURES)	TOTAL (IN FIGURES)
BASE BID SCHEDULE: La Sierra Avenue Resurfacing Project						
28	820410	SALVAGE ROADSIDE SIGN	EA	47		
29	820840	ROADSIDE SIGN - ONE POST	EA	46		
30	820850	ROADSIDE SIGN - TWO POST	EA	3		
31	840519	THERMOPLASTIC CROSSWALK AND PAVEMENT MARKING	SQFT	2,455		
32	840656	PAINT TRAFFIC STRIPE (2-COAT)	LF	65,000		
33	846051	12" RUMBLE STRIP (ASPHALT CONCRETE PAVEMENT)	STA	43		
34	870111	INDUCTIVE LOOP DETECTOR (EA)	EA	26		
35	010602	MISCELLANEOUS WORK (AS DIRECTED)	FA	1	207,000.00	207,000.00

BASE BID SCH.

SUB-TOTAL: _____ \$ _____
ITEMS 1-35 "WORDS"

ALTERNATE BID SCHEDULE 1: Western Municipal Water District (WMWD) Facilities Adjustments

36	710200	ADJUST MANHOLE	EA	38		
----	--------	----------------	----	----	--	--

ALTERNATE BID SCH. 1

SUB-TOTAL: _____ \$ _____
ITEM 36 "WORDS"

ALTERNATE BID SCHEDULE 2 - City of Riverside Facilities Adjustments

37	710200	ADJUST MANHOLE	EA	7		
----	--------	----------------	----	---	--	--

ALTERNATE BID SCH. 2

SUB-TOTAL: _____ \$ _____
ITEM 37 "WORDS"

BASE BID SCHEDULES and ALTERNATE BID SCHEDULES 1 and 2

PROJECT TOTAL: _____ \$ _____
ITEMS 1-37 "WORDS"

Addendum No. 1, Page 5 of 13

CONSTRUCTION NOTES:

- 1 PROTECT IN PLACE
- 2 MATCH EXISTING
- 3 ADJUST WATER VALVE TO GRADE BY COUNTY
- 4 ADJUST SEWER MANHOLE TO GRADE BY WMD
- 5 ADJUST TELEPHONE MANHOLE TO GRADE BY AT&T
- 6 COLD PLANE EXISTING ASPHALT CONCRETE TO A DEPTH OF 0.15"; PAVE BACK WITH 0.17" OF RHMA, TYPE "C", PG64-16, 1/2" MIX
- 7 ADJUST STORM DRAIN MANHOLE TO GRADE BY COUNTY
- 8 ADJUST GAS VALVE TO GRADE BY COUNTY
- 9 RECONSTRUCT CURB RAMP PER COUNTY STD NO. 403 (CASE A)
- 10 RECONSTRUCT SPANDREL PER COUNTY STD NO. 209
- 11 REPLACE GROSS GUTTER PER COUNTY STD NO. 209
- 12 ADJUST WMD WATER VALVE TO GRADE BY COUNTY

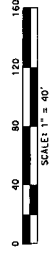
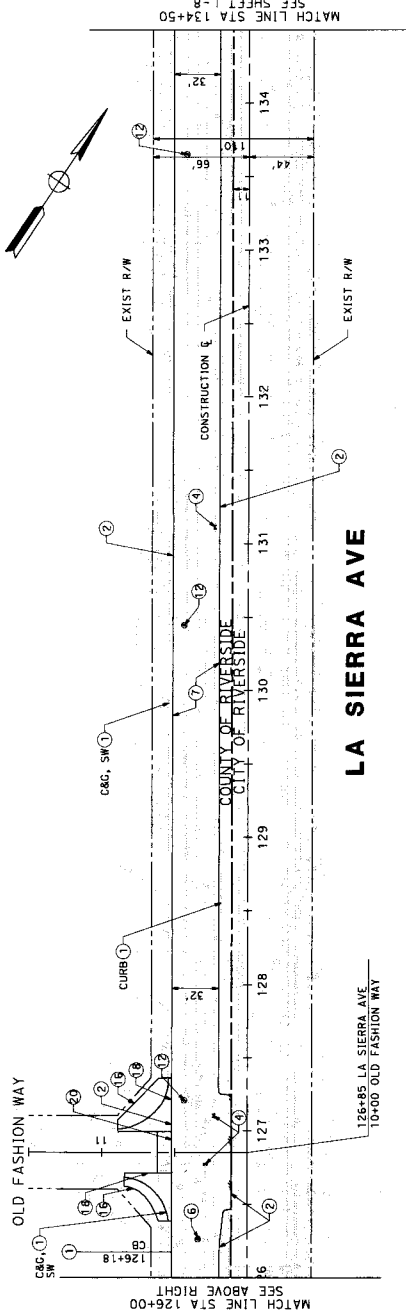
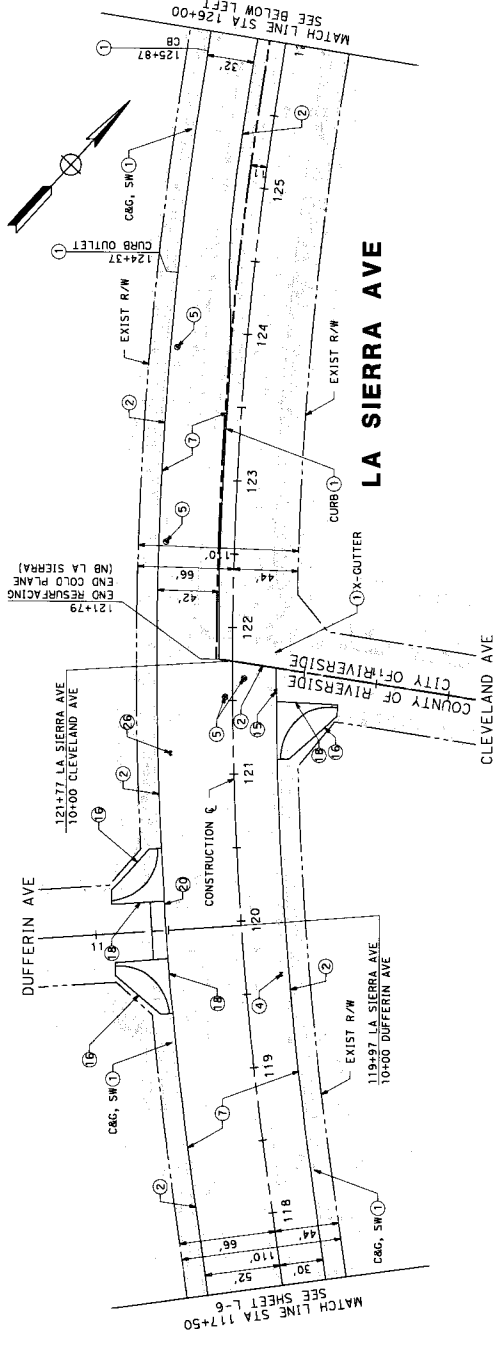

SPECIAL NOTES:

1. ALL EXISTING UTILITIES, UTILITY APPURTENANCES, OR OTHER ITEMS THAT ARE BEHIND C&G, SIDEWALK, OR DIKE ARE TO BE PROTECTED-IN-PLACE UNLESS OTHERWISE SPECIFIED ON PLANS.
2. ALL EXISTING UTILITIES, UTILITY APPURTENANCES, OR OTHER ITEMS WITHIN EXISTING CURB RAMPS, CROSS GUTTERS, OR SPANDRELS, WHICH ARE TO BE RECONSTRUCTED, ARE TO BE PROTECTED-IN-PLACE UNLESS OTHERWISE SPECIFIED ON PLANS.
3. GUARDRAIL ADJUSTMENTS TO BE PERFORMED AS PART OF FUTURE PROJECT.

BORDER LAST REVISED 07/21/2015

PREPARED BY

Michael Baker
CORPORATION
INTERNATIONAL
PREPARED UNDER THE SUPERVISION OF:
DANIEL R. ANDERSON
DATE: 08/13/16

LAYOUT

LA SIERRA AVENUE
ROADWAY RESURFACING
117+50 TO 134+50

SHEET No.

L-7r

SHEET 10 of 20

WO 06-0074

COUNTY

FILE No.



966-C

CONSTRUCTION NOTES:

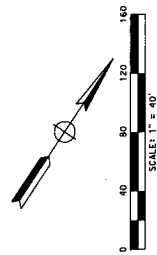
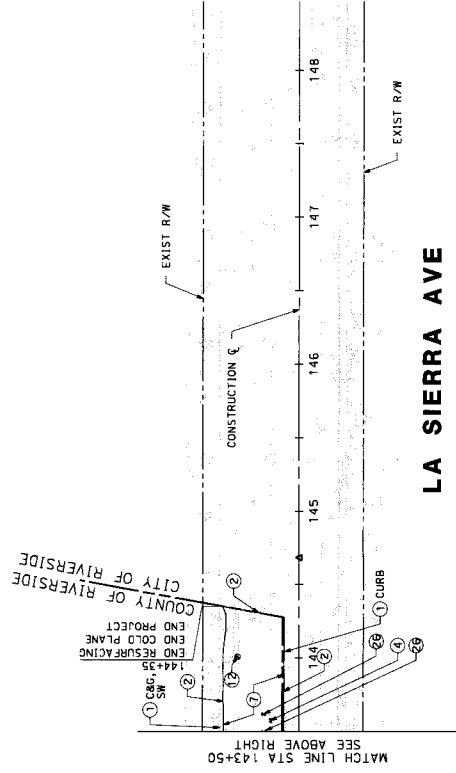
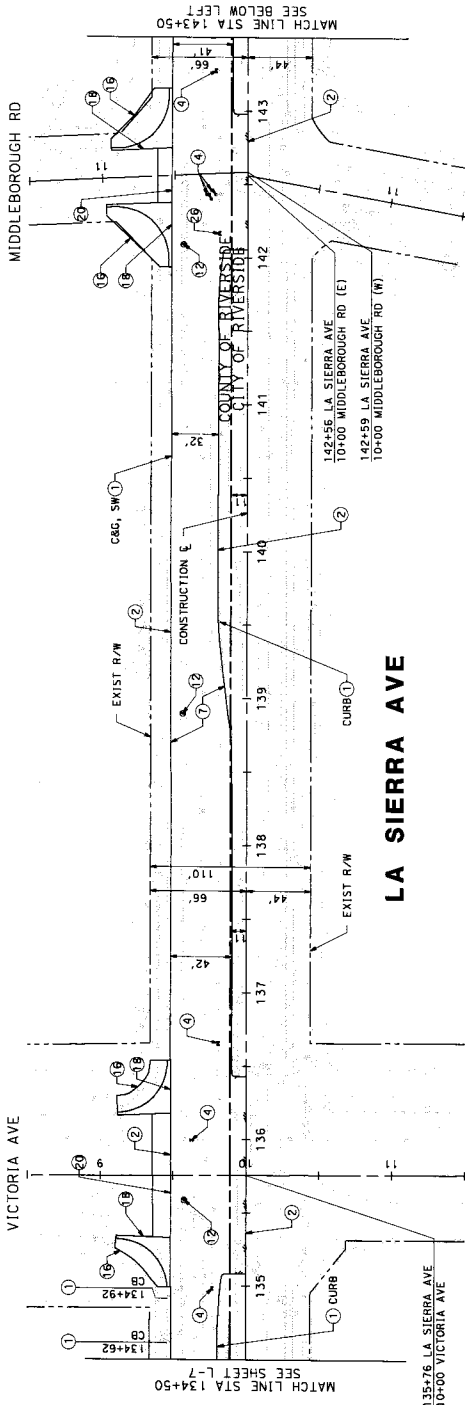
- 1 PROTECT IN PLACE
- 2 MATCH EXISTING
- 3 ADJUST WATER VALVE TO GRADE BY COUNTY
- 4 COLD PLANE EXISTING ASPHALT CONCRETE TO A DEPTH OF 0.15'; PAVE BACK WITH 0.17' OF RHMA, TYPE "C", PG64-16, 1/2" MIX
- 5 ADJUST STORM DRAIN MANHOLE TO GRADE BY COUNTY
- 6 RECONSTRUCT CURB RAMP PER COUNTY STD NO. 403 (CASE A)
- 7 RECONSTRUCT SPANDREL PER COUNTY STD NO. 209
- 8 REPLACE CROSS CUTTER PER COUNTY STD NO. 209
- 9 ADJUST WWWD WATER VALVE TO GRADE BY COUNTY



- SPECIAL NOTES:**
1. ALL EXISTING UTILITIES, UTILITY APPURTENANCES, OR OTHER ITEMS THAT ARE BEHIND C&G, SIDEWALK, OR DIKE ARE TO BE PROTECTED-IN-PLACE UNLESS OTHERWISE SPECIFIED ON PLANS.
 2. ALL EXISTING UTILITIES, UTILITY APPURTENANCES, OR OTHER ITEMS WITHIN EXISTING CURB RAMPS, CROSS CUTTERS, OR SPANDRELS, WHICH ARE TO BE RECONSTRUCTED, ARE TO BE PROTECTED-IN-PLACE UNLESS OTHERWISE SPECIFIED ON PLANS.
 3. GUARDRAIL ADJUSTMENTS TO BE PERFORMED AS PART OF FUTURE PROJECT.

PREPARED BY

Michael Baker INTERNATIONAL CORPORATION
 PREPARED UNDER THE SUPERVISION OF:

 DANIEL R. BAKER
 LICENSE NO. 42533, EXPIRES 08/15/18

LAYOUT
LA SIERRA AVENUE
 ROADWAY RESURFACING
 134+50 TO 144+50

SHEET No. 11 of 20
L-81
966-C

MO C6-0074 COUNTY FILE NO.

STRIPING NOTES:

- 12 PAINT LANE LINE STRIPE AND INSTALL MARKERS PER CALTRANS STD A200, DETAIL 12
- 22 PAINT NO PASSING ZONE STRIPES AND INSTALL MARKERS PER CALTRANS STD A204, DETAIL 22
- 27B PAINT EDGE LINE STRIPE PER CALTRANS STD A208, DETAIL 27B (6" STRIPE)
- 29 PAINT MEDIAN ISLAND STRIPES AND INSTALL MARKERS PER DETAIL 29 (MOD) ON SHEET C-1
- 32 PAINT TWO-WAY LEFT TURN LANE STRIPES AND INSTALL MARKERS PER CALTRANS STD A208, DETAIL 32
- 37B PAINT LANE DROP AT INTERSECTION STRIPE AND INSTALL MARKERS PER CALTRANS STD A200, DETAIL 37B
- 38 PAINT CHANNELIZING STRIPE AND INSTALL MARKERS PER DETAIL 38 (MOD) ON SHEET C-1
- 38A PAINT CHANNELIZING STRIPE PER CALTRANS STD A200, DETAIL 38A
- 39 PAINT BIKE LANE LINE STRIPE PER CALTRANS STD A200, DETAIL 39
- 39A PAINT INTERSECTION LINE BIKE LANE STRIPE PER CALTRANS STD A200, DETAIL 39A
- LL INSTALL THERMOPLASTIC LIMIT LINE PER CALTRANS STD A24E
- PM INSTALL THERMOPLASTIC PAVEMENT MARKINGS AS SHOWN PER CALTRANS STD A24A THROUGH A24E AS INDICATED ON PLANS
- EW INSTALL THERMOPLASTIC 12" WHITE BASIC CROSSWALK PAVEMENT MARKINGS PER CALTRANS STD A24F
- A PAINT 4" WHITE CHANNELIZING STRIPE AND INSTALL RETROREFLECTIVE PAVEMENT MARKERS (TYPE G) EVERY 25' LOCATED 3' TO THE RIGHT SIDE OF STRIPE

CONSTRUCTION NOTES:

- 1 PROTECT IN PLACE
- 11 INSTALL TRAFFIC DETECTOR LOOP PER STD NO. 1201
- 23 SALVAGE EXISTING SIGN AND INSTALL NEW SIGN PER STD NO. 1222
- 27 INSTALL NEW SIGN PER COUNTY STD NO. 1222

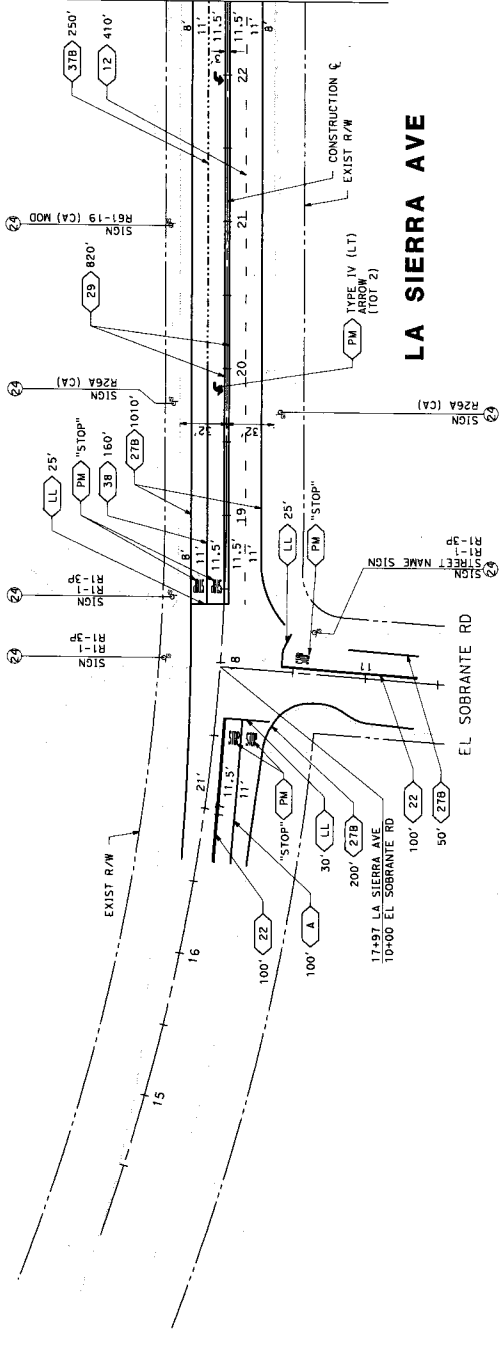
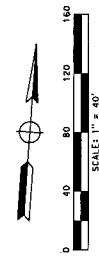

LA SIERRA AVE

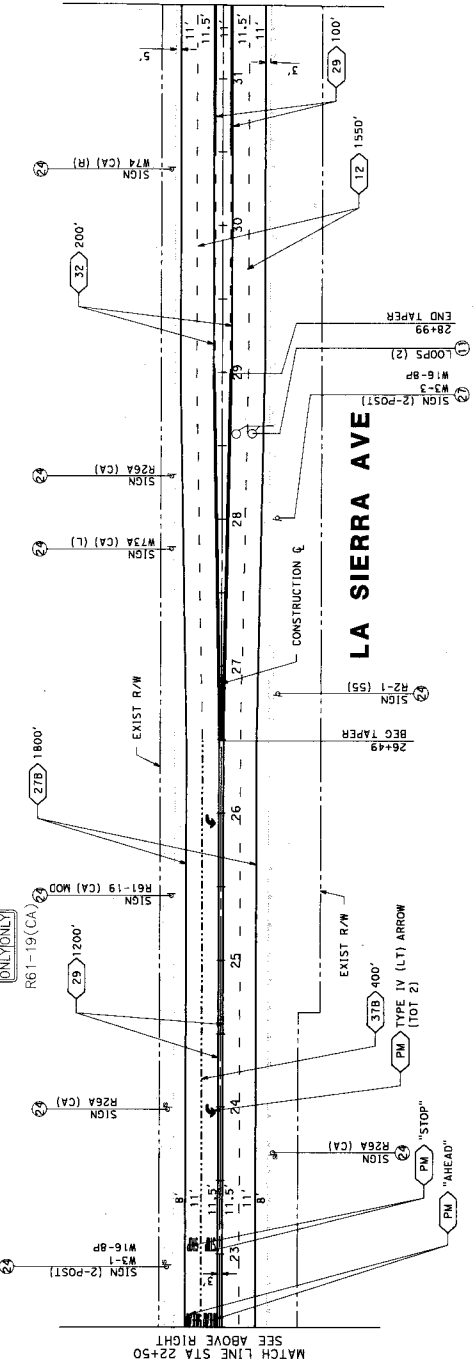

SPECIAL NOTE:

- 1. ALL STRIPING SHOULD BE 4" UNLESS OTHERWISE NOTED
- 2. ALL SIGNS ARE ONE POST UNLESS OTHERWISE NOTED
- 3. ALL LETTERING FOR M16-BP SIGNS WILL BE 8" UPPER CASE AND 6" LOWER CASE

BORDER LAST REVISED 07/21/2015

PREPARED BY

Michael Baker International, Inc.
 238 S. Broadway St.
 Orange, CA 92668
 PREPARED UNDER THE SUPERVISION OF:
DANIEL R. WINDIG
 LICENSE NO. 42528
 DATE: 08/14/15
 USERNAME: drcrnl-yozswo
 DON FILE: 163770_no_pd-1.dgn

PVMT DELINEATION, ELECTRICAL, & SIGNS SHEET NO.

LA SIERRA AVENUE
ROADWAY RESURFACING
 17+50 TO 31+50

PD-1r
 SHEET 13 OF 20

NO. C6-0074 COUNTY FILE NO. **966-C**

STRIPING NOTES:

- 12 PAINT LANE LINE STRIPE AND INSTALL MARKERS PER CALTRANS STD A20A, DETAIL 12
- 22 PAINT NO PASSING ZONE STRIPES AND INSTALL MARKERS PER CALTRANS STD A20A, DETAIL 22
- 27B PAINT EDGE LINE STRIPE PER CALTRANS STD A20B, DETAIL 27B (6" STRIPE)
- 29 PAINT MEDIAN ISLAND STRIPES AND INSTALL MARKERS PER DETAIL 29 (MOD) ON SHEET C-1
- 38 PAINT CHANNELIZING STRIPE AND INSTALL MARKERS PER DETAIL 38 (MOD) ON SHEET C-1
- 38A PAINT CHANNELIZING STRIPE PER CALTRANS STD A20D, DETAIL 38A
- LL INSTALL THERMOPLASTIC LIMIT LINE PER CALTRANS STD A24E
- PM INSTALL THERMOPLASTIC PAVEMENT MARKINGS AS SHOWN PER CALTRANS STD A24A THROUGH A24E AS INDICATED ON PLANS
- CW INSTALL THERMOPLASTIC 12" WHITE BASIC CROSSWALK PAVEMENT MARKINGS PER CALTRANS STD A24F
- A PAINT 4" WHITE CHANNELIZING STRIPE AND INSTALL RETROREFLECTIVE PAVEMENT MARKERS (TYPE G) EVERY 25' LOCATED 3" TO THE RIGHT SIDE OF STRIPE

CONSTRUCTION NOTES:

- 1 PROTECT IN PLACE
- 11 INSTALL TRAFFIC DETECTOR LOOP PER STD NO. 1201
- 24 SALVAGE EXISTING SIGN AND INSTALL NEW SIGN PER STD NO. 1222
- 27 INSTALL NEW SIGN PER COUNTY STD NO. 1222

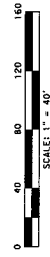
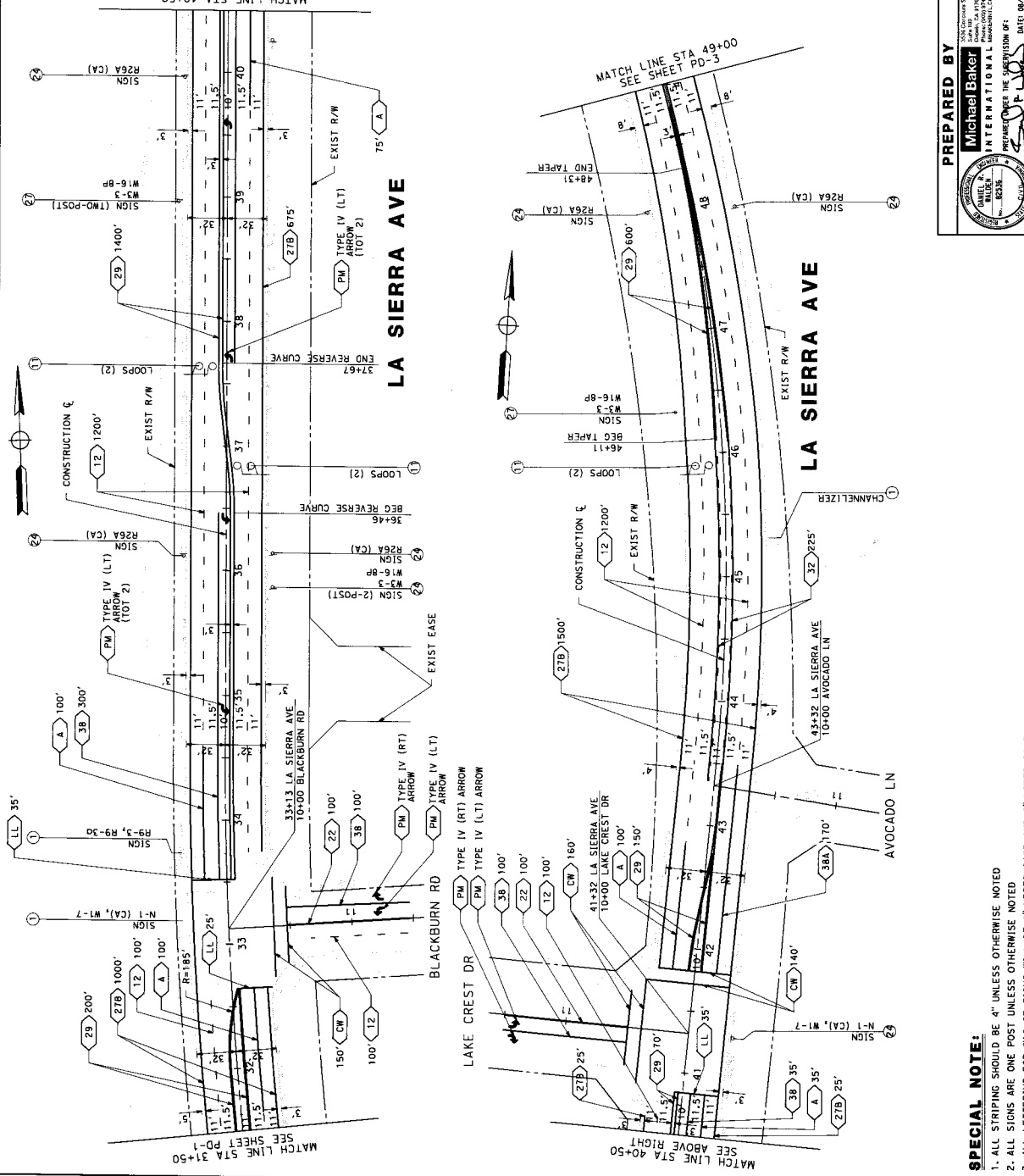

SPECIAL NOTE:

- 1. ALL STRIPING SHOULD BE 4" UNLESS OTHERWISE NOTED
- 2. ALL SIGNS ARE ONE POST UNLESS OTHERWISE NOTED
- 3. ALL LETTERING FOR M16-RP SIGNS WILL BE 8" UPPER CASE, AND 6" LOWER CASE

BORDER LAST REVISED 07/21/2015

PREPARED BY
 Michael Baker
 INTERNATIONAL
 11000 E. Southwestern Ave.
 Suite 100
 Denver, CO 80231
 Phone: (303) 752-4000
 Fax: (303) 752-4009
 www.mbakercorp.com

DATE: 08/14/2018
DRAWN BY: JTB

APPROVED BY:
 DANIEL R. WILSON
 LICENSED PROFESSIONAL ENGINEER
 STATE OF CALIFORNIA
 LICENSE NO. 68499

PVMT DELINEATION, ELECTRICAL, & SIGNS SHEET NO.
LA SIERRA AVENUE
ROADWAY RESURFACING
31+50 TO 49+00

PD-2r
 SHEET 14 OF 20

966-C
 COUNTY FILE NO.
 MO C6-0074

ISSUED BY ADDENDUM NO. 1, ATTACHMENT 'B'

DATE PLOTTED: 16-AUG-2018 16:03
 LAST REVISION: 00-00-00

STRIPING NOTES:

- 12 PAINT LANE LINE STRIPE AND INSTALL MARKERS PER CALTRANS STD A20A, DETAIL 12
- 22 PAINT NO PASSING ZONE STRIPES AND INSTALL MARKERS PER CALTRANS STD A20A, DETAIL 22
- 27B PAINT EDGE LINE STRIPE PER CALTRANS STD A20B, DETAIL 27B (6" STRIPE)
- 29 PAINT MEDIUM ISLAND STRIPES AND INSTALL MARKERS PER DETAIL 29 (MOD) ON SHEET C-1
- 37B PAINT LANE DROP AT INTERSECTION STRIPE AND INSTALL MARKERS PER CALTRANS STD A20C, DETAIL 37B

CONSTRUCTION NOTES:

- 1 PROTECT IN PLACE
- 2 INSTALL TRAFFIC DETECTOR LOOP PER STD NO. 1201
- 3 SALVAGE EXISTING SIGN AND INSTALL NEW SIGN PER STD NO. 1222

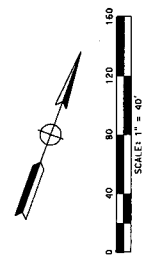
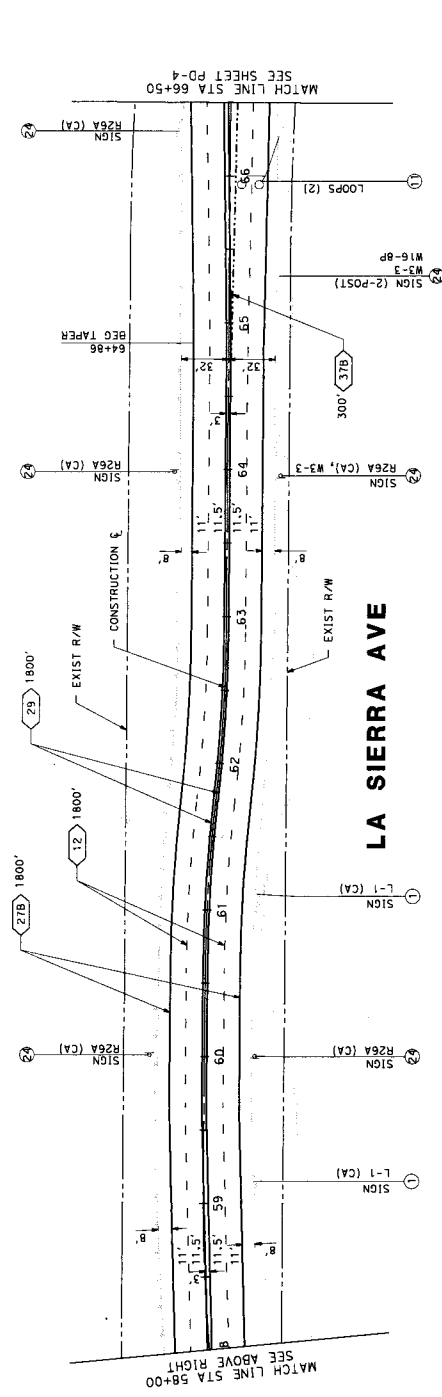
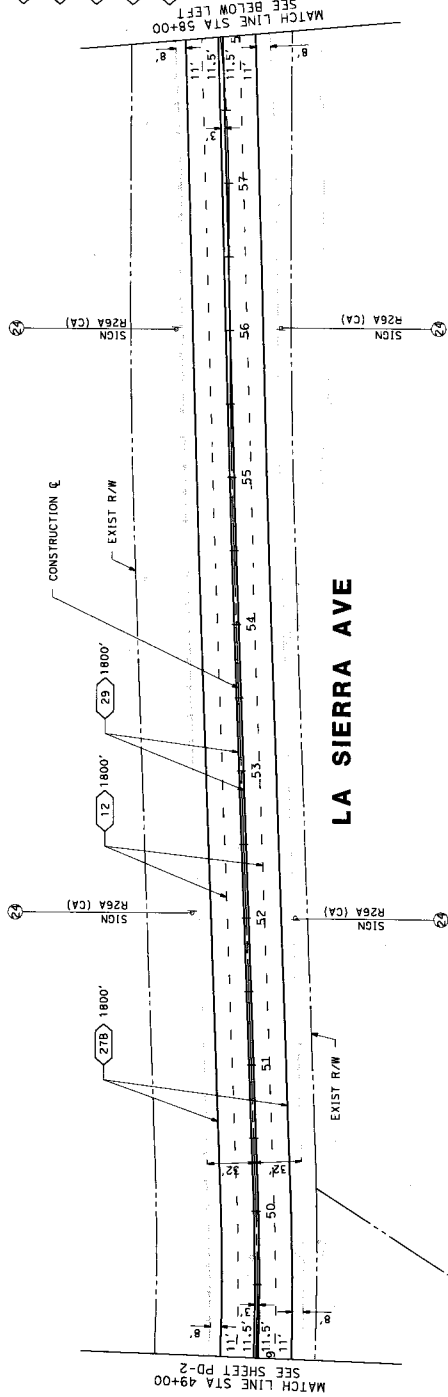

ISSUED BY ADDENDUM NO. 1, ATTACHMENT "B"

DATE PLOTTED: 16-AUG-2018

PROJECT: LA SIERRA AVE ROADWAY RESURFACING

PREPARED BY: Michael Baker International

PROJECT NO: 16S770-00-PD-3

DATE: 07/21/2015

FILE NO: 966-C

MO C6-0074

LA SIERRA AVE ROADWAY RESURFACING 49+00 TO 66+50

SHEET 15 OF 20

PREPARED FOR THE DIVISION OF: CALIFORNIA HIGHWAYS

DATE: 07/21/2015

FILE NO: 16S770-00-PD-3

SPECIAL NOTE:

- 1. ALL STRIPING SHOULD BE 4" UNLESS OTHERWISE NOTED
- 2. ALL SIGNS ARE ONE POST UNLESS OTHERWISE NOTED
- 3. ALL LETTERING FOR R16-8P SIGNS WILL BE 8" UPPER CASE AND 6" LOWER CASE

STRIPING NOTES:

- 12 PAINT LANE LINE STRIPE AND INSTALL MARKERS PER CALTRANS STD A20A, DETAIL 12
- 22 PAINT NO PASSING ZONE STRIPES AND INSTALL MARKERS PER CALTRANS STD A20A, DETAIL 22
- 27B PAINT EDGE LINE STRIPE PER CALTRANS STD A20B, DETAIL 27B (6" STRIPE)
- 29 PAINT MEDIAN ISLAND STRIPES AND INSTALL MARKERS PER DETAIL 29 (MOD) ON SHEET C-1
- 37B PAINT LANE DROP AT INTERSECTION STRIPE AND INSTALL MARKERS PER CALTRANS STD A20C, DETAIL 37B
- 38 PAINT CHANNELIZING STRIPE AND INSTALL MARKERS PER DETAIL 38 (MOD) ON SHEET C-1
- LL INSTALL THERMOPLASTIC LIMIT LINE PER CALTRANS STD A24E
- PM INSTALL THERMOPLASTIC PAVEMENT MARKINGS AS SHOWN PER CALTRANS STD A24A THROUGH A24E AS INDICATED ON PLANS
- CR INSTALL THERMOPLASTIC 12" WHITE BASIC CROSSWALK PAVEMENT MARKINGS PER CALTRANS STD A24F
- A PAINT 4" WHITE CHANNELIZING STRIPE AND INSTALL RETROREFLECTIVE PAVEMENT MARKERS (TYPE G) EVERY 25' LOCATED 3' TO THE RIGHT SIDE OF STRIPE

CONSTRUCTION NOTES:

- 1 PROTECT IN PLACE
- 2 INSTALL TRAFFIC DETECTOR LOOP PER STD NO. 1201
- 3 SALVAGE EXISTING SIGN AND INSTALL NEW SIGN PER STD NO. 1222

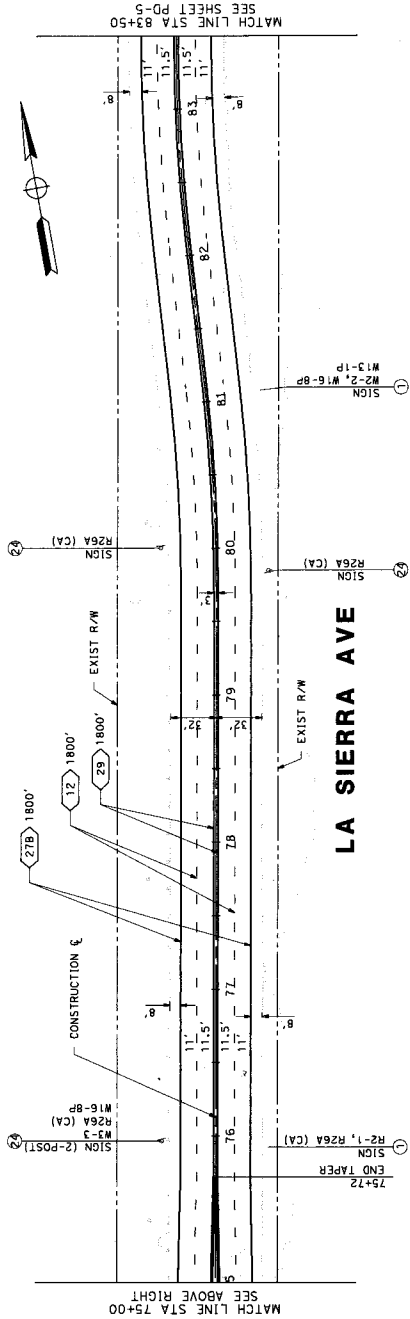
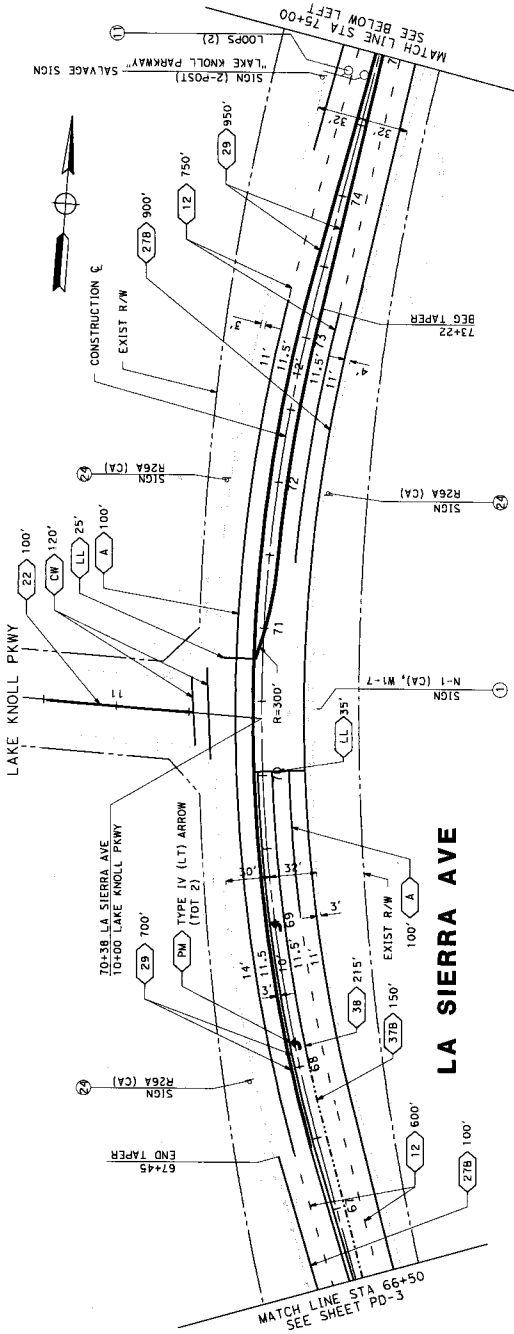
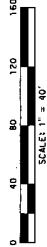

SPECIAL NOTE:

- 1. ALL STRIPING SHOULD BE 4" UNLESS OTHERWISE NOTED
- 2. ALL SIGNS ARE ONE POST UNLESS OTHERWISE NOTED
- 3. ALL LETTERING FOR W1-6-BP SIGNS WILL BE 8" UPPER CASE AND 6" LOWER CASE

BORDER LAST REVISED 07/21/2015

PREPARED BY Michael Baker International
 10000 Lake Knoll Parkway, Suite 1000, Lake Knoll, CA 92546
 PHONE: (951) 823-8800 FAX: (951) 823-8801
 WWW: www.michaelbaker.com
 PROJECT NO. 155710-PCS-PD-4.dgn
 SHEET NO. 16 OF 20
 COUNTY FILE NO. 966-C
 DATE PLOTTED: 16-AUG-2018

STRIPING NOTES:

- (12) PAINT LANE LINE STRIPE AND INSTALL MARKERS PER CALTRANS STD A204, DETAIL 12
- (22) PAINT NO PASSING ZONE STRIPES AND INSTALL MARKERS PER CALTRANS STD A204, DETAIL 22
- (27B) PAINT EDGELINE STRIPE PER CALTRANS STD A208, DETAIL 27B (6" STRIPE)
- (29) PAINT MEDIAN ISLAND STRIPES AND INSTALL MARKERS PER DETAIL 29 (MOD) ON SHEET C-1
- (32) PAINT TWO-WAY LEFT TURN LANE STRIPES AND INSTALL MARKERS PER CALTRANS STD A208, DETAIL 32
- (38) PAINT CHANNELIZING STRIPE AND INSTALL MARKERS PER DETAIL 38 (MOD) ON SHEET C-1
- (38A) PAINT CHANNELIZING STRIPE PER CALTRANS STD A200, DETAIL 38A
- (LL) INSTALL THERMOPLASTIC LIMIT LINE PER CALTRANS STD A24E
- (PM) INSTALL THERMOPLASTIC PAVEMENT MARKINGS AS SHOWN PER CALTRANS STD A24A THROUGH A24E AS INDICATED ON PLANS
- (A) PAINT 4" WHITE CHANNELIZING STRIPE AND INSTALL RETROREFLECTIVE PAVEMENT MARKERS (TYPE C) EVERY 25' LOCATED 3" TO THE RIGHT SIDE OF STRIPE

CONSTRUCTION NOTES:

- (1) PROTECT IN PLACE
- (2) SALVAGE EXISTING SIGN AND INSTALL NEW SIGN PER STD No. 1222

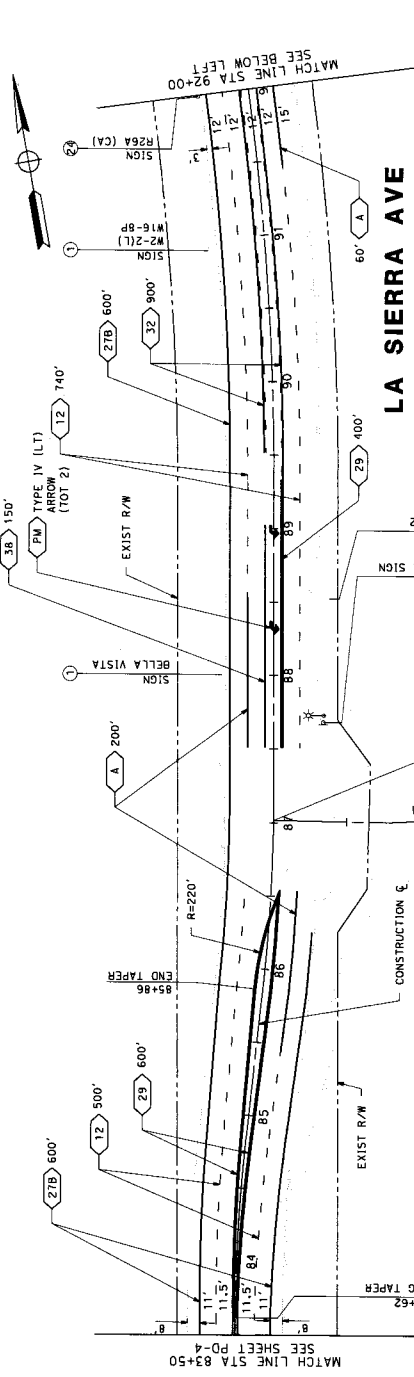

LA SIERRA AVE

CARRARA CT

LA SIERRA AVE

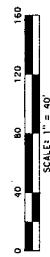
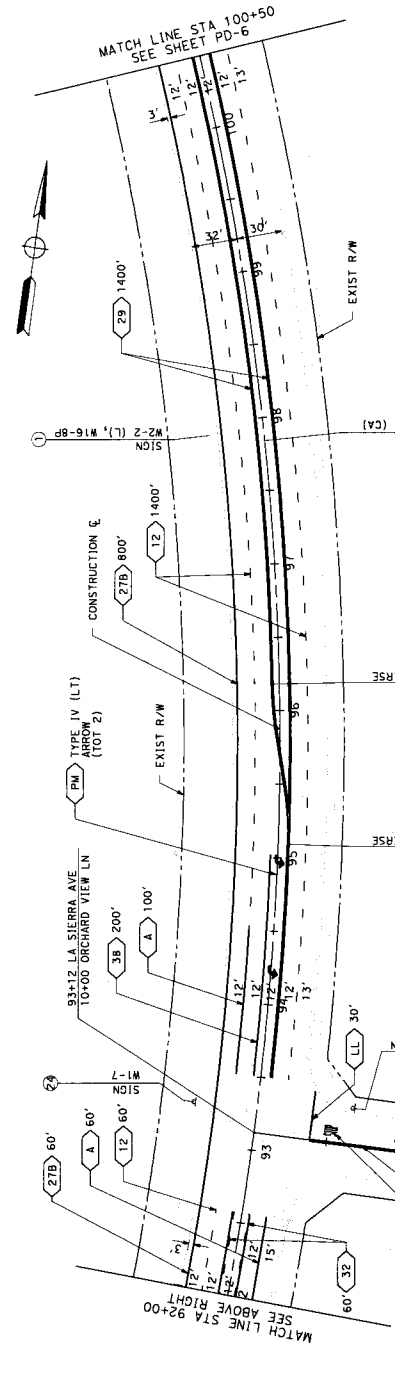

PREPARED BY

Michael Baker International
 3745 GARDNER ST., SUITE 200
 OAKLAND, CA 94612
 TEL: 415.774.2000
 FAX: 415.774.2001
 WWW.MBI.COM
 PREPARED UNDER THE SUPERVISION OF:
DANIEL R. WALSH
 LICENSED PROFESSIONAL ENGINEER
 LICENSE NO. 68238
 STATE OF CALIFORNIA

PVMT DELINEATION, ELECTRICAL, & SIGNS SHEET NO.
LA SIERRA AVENUE
 ROADWAY RESURFACING
 83+50 TO 100+50

PD-51r
 SHEET 17 of 20

USER NAME: rjordan_yzozawa
 DGN FILE: 165770.dwg, PD-5.dgn
 NO. CG-0074
 COUNTY FILE NO. **966-C**

SPECIAL NOTE:

- 1. ALL STRIPING SHOULD BE 4" UNLESS OTHERWISE NOTED
- 2. ALL SIGNS ARE ONE POST UNLESS OTHERWISE NOTED
- 3. ALL LETTERING FOR W16-RP SIGNS WILL BE 8" UPPER CASE AND 6" LOWER CASE

BORDER LAST REVISED 07/21/2015

STRIPING NOTES:

- 12 PAINT LANE LINE STRIPE AND INSTALL MARKERS PER CALTRANS STD A20A, DETAIL 12
- 22 PAINT NO PASSING ZONE STRIPES AND INSTALL MARKERS PER CALTRANS STD A20A, DETAIL 22
- 27B PAINT EDGE LINE STRIPE PER CALTRANS STD A20B, DETAIL 27B (6" STRIPE)
- 29 PAINT MEDIAN ISLAND STRIPES AND INSTALL MARKERS PER DETAIL 29 (MOD) ON SHEET C-1
- 32 PAINT TWO-WAY LEFT TURN LANE STRIPES AND INSTALL MARKERS PER CALTRANS STD A20B, DETAIL 32
- 37B PAINT LANE DROP AT INTERSECTION STRIPE AND INSTALL MARKERS PER CALTRANS STD A20C, DETAIL 37B
- 38 PAINT CHANNELIZING STRIPE AND INSTALL MARKERS PER DETAIL 38 (MOD) ON SHEET C-1
- 39 PAINT BIKE LANE LINE STRIPE PER CALTRANS STD A20D, DETAIL 39
- 39A PAINT INTERSECTION LINE BIKE LANE STRIPE PER CALTRANS STD A20D, DETAIL 39A
- LL INSTALL THERMOPLASTIC LIMIT LINE PER CALTRANS STD A24E
- PM INSTALL THERMOPLASTIC PAVEMENT MARKINGS AS SHOWN PER CALTRANS STD A24A THROUGH A24E AS INDICATED ON PLANS
- CP INSTALL THERMOPLASTIC 12" WHITE BASIC CROSSWALK PAVEMENT MARKINGS PER CALTRANS STD A24F
- A PAINT 4" WHITE CHANNELIZING STRIPE AND INSTALL RETROREFLECTIVE PAVEMENT MARKERS (TYPE G) EVERY 25' LOCATED 3" TO THE RIGHT SIDE OF STRIPE

CONSTRUCTION NOTES:

- 1 PROTECT IN PLACE
- 2 INSTALL TRAFFIC DETECTOR LOOP PER STD NO. 1201
- 3 SALVAGE EXISTING SIGN AND INSTALL NEW SIGN PER STD NO. 1222
- 4 INSTALL NEW SIGN PER COUNTY STD NO. 1222

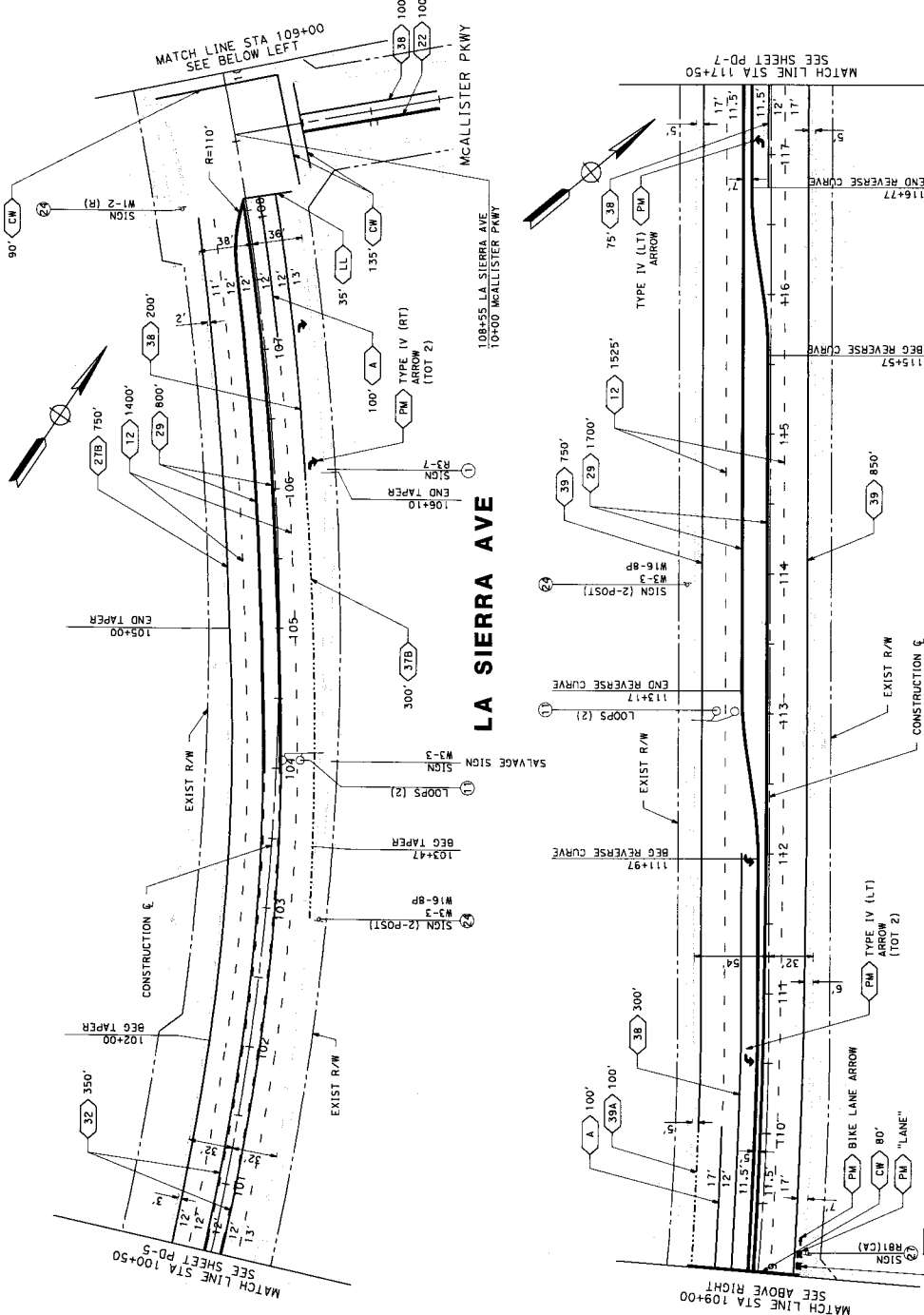

LA SIERRA AVE

PREPARED BY **Michael Baker**
 INTERNATIONAL
 ENGINEERS, ARCHITECTS, PLANNERS AND ENVIRONMENTAL SCIENTISTS
 1000 WEST 10TH AVENUE, SUITE 1000
 DENVER, COLORADO 80202
 PHONE: (303) 733-8800
 FAX: (303) 733-8801
 WWW.MBI.US

PVMT DELINEATION, ELECTRICAL, & SIGNS SHEET NO. PD-6r
LA SIERRA AVENUE
ROADWAY RESURFACING
 100+50 TO 117+50
 SHEET 18 OF 20
 COUNTY FILE NO. 966-C
 WORK NO. CG-0074
 DESIGNER: J. S. HANSEN, J. S. HANSEN & ASSOCIATES, INC.
 CHECKER: R. W. HANSEN, J. S. HANSEN & ASSOCIATES, INC.
 DATE: 07/21/2015



SPECIAL NOTE:

- 1. ALL STRIPING SHOULD BE 4" UNLESS OTHERWISE NOTED
- 2. ALL SIGNS ARE ONE POST UNLESS OTHERWISE NOTED
- 3. ALL LETTERING FOR M18-BP SIGNS WILL BE 8" UPPER CASE AND 6" LOWER CASE

BORDER LAST REVISED 07/21/2015

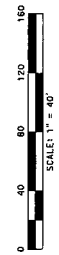

Bid

Date: August 15, 2018

To: County of Riverside, hereafter called "County";

Bidder: All American Asphalt
(hereafter called "Contractor")

The undersigned, Contractor, having carefully examined the site and the Contract Documents for the construction of La Sierra Avenue Resurfacing Project, El Sobrante Road to County of Riverside/ City of Riverside Boundary, Community of Lake Hills, Project No. C6-0074 hereby proposes to construct the work in accordance with the Contract Documents, including **Addenda Number(s)** 1 (Fill in addenda numbers if addenda have been issued.) for the amount stated in this Bid.

By submitting this Bid, Contractor agrees with County:

1. That unless withdrawn in person by Contractor or some person authorized in writing by Contractor (not by telephone or facsimile) before the time specified in the Notice Inviting Bids for the public opening of bids, this Bid constitutes an irrevocable offer for 90 calendar days after that date.
2. County has the right to reject any or all Bids and to waive any irregularities or informalities contained in a Bid.
3. To execute the Contract and deliver the Performance Bond, Payment Bond and Insurance Certificate with endorsements, that comply with the requirements set forth in the Instruction to Bidders and General Conditions within ten (10) business days of the date of the Notice of Acceptance of Bid and Intent to Award as issued by the County.
4. That the contract shall be awarded upon a resolution or minute order to that effect duly adopted by the governing body of County; and that execution of the Contract shall constitute a written memorial thereof.
5. To submit to the County such information as County may require determining whether a particular Bid is the lowest responsible bid submitted.
6. That the accompanying Bid Bond, certified check or cashier's check is in an amount not less than 10% of the total bid submitted and constitutes a guarantee that if awarded the contract, Contractor will execute the Contract and deliver the required bonds within ten (10) business days after notice of award. If Contractor fails to execute and deliver said documents, the bond or check is to be charged with the costs of the resultant damages to the County, including but not limited to: publication costs, the difference in money between the amount bid and the amount in excess of the bid which it costs County to do or cause to be done for the work involved, lease and rental costs, additional salaries and overhead, increased interest and costs of funding the project, attorney expense, additional engineering and architectural expense and cost of maintaining or constructing alternate facilities occasioned by the failure to execute and deliver said documents.
7. By signing this Bid the Contractor certifies that the representations made therein are made under penalty of perjury.

La Sierra Avenue Resurfacing Project
El Sobrante Road to County of Riverside/City of Riverside Boundary
Community of Lake Hills
Project No. C6-0074

REVISED PROPOSAL

ITEM No.	ITEM CODE	ITEM	UNIT	ESTIMATED QUANTITY	ITEM PRICE (IN FIGURES)	TOTAL (IN FIGURES)
BASE BID SCHEDULE: La Sierra Avenue Resurfacing Project						
1	100100	DEVELOP WATER SUPPLY	LS	1	1,465.00	1,465.00
2	120100	TRAFFIC CONTROL SYSTEM	LS	1	59,400.00	59,000.00
3	130200	PREPARE WATER POLLUTION CONTROL PROGRAM	LS	1	1,250.00	1,250.00
4	170103	CLEARING AND GRUBBING (LS)	LS	1	10,500.00	10,500.00
5	066100	DUST ABATEMENT	LS	1	9,600.00	9,600.00
6	860201	SIGNAL AND LIGHTING (BLACKBURN RD)	LS	1	33,150.00	33,150.00
7	860201	SIGNAL AND LIGHTING (LAKE CREST DR)	LS	1	33,150.00	33,150.00
8	860201	SIGNAL AND LIGHTING (LAKE KNOLL PKWY)	LS	1	33,150.00	33,150.00
9	860201	SIGNAL AND LIGHTING (MCALLISTER PKWY)	LS	1	33,150.00	33,150.00
10	013902	ASPHALT CONCRETE OVERSIDE DRAIN (CRS 306)	EA	10	363.00	3,630.00
11	013903	PLACE ASPHALT CONCRETE DIKE (CRS 212) (6")	LF	13,035	1.70 1.70	22,159.50
12	013908	ASPHALT CONCRETE DRIVEWAY	SQFT	1,155	9.20	10,626.00
13	390132	HOT MIX ASPHALT (TYPE A)	TON	520	65.50	34,060.00
14	390137	RUBBERIZED HOT MIX ASPHALT (GAP GRADED)	TON	10,105	90.50	914,502.50
15	394074	PLACE HOT MIX ASPHALT DIKE (TYPE C)	LF	580	1.70	986.00
16	398200	COLD PLANE ASPHALT CONCRETE PAVEMENT	SQYD	88,440	1.95	172,458.00
17	510501	MINOR CONCRETE	CY	3	900.00	2,700.00
18	000001	ITEM DELETED PER ADDENDUM No. 1	-----	-----	-----	-----
19	000001	ITEM DELETED PER ADDENDUM No. 1	-----	-----	-----	-----
20	000001	ITEM DELETED PER ADDENDUM No. 1	-----	-----	-----	-----
21	000001	ITEM DELETED PER ADDENDUM No. 1	-----	-----	-----	-----
22	017302	MINOR CONCRETE (CROSS-GUTTER) (CRS 209)	SQFT	4,375	23.00	100,625.00
23	017303	MINOR CONCRETE (SPANDREL) (CRS 209)	SQFT	5,315	22.00	116,930.00
24	017315	MINOR CONCRETE (CURB RAMP) (CRS 403 - CASE A)	EA	15	5,100.00	76,500.00
25	017316	MINOR CONCRETE (CURB RAMP) (CRS 403 - CASE B)	EA	1	5,600.00	5,600.00
26	810230	PAVEMENT MARKER (RETROREFLECTIVE)	EA	1,702	4.00	6,808.00
27	820130	OBJECT MARKER	EA	25	57.00	1,425.00

REVISED PROPOSAL

ITEM No.	ITEM CODE	ITEM	UNIT	ESTIMATED QUANTITY	ITEM PRICE (IN FIGURES)	TOTAL (IN FIGURES)
BASE BID SCHEDULE: La Sierra Avenue Resurfacing Project						
28	820410	SALVAGE ROADSIDE SIGN	EA	47	411.00	1,927.00
29	820840	ROADSIDE SIGN - ONE POST	EA	46	311.00	14,306.00
30	820850	ROADSIDE SIGN - TWO POST	EA	3	777.00	2,331.00
31	840519	THERMOPLASTIC CROSSWALK AND PAVEMENT MARKING	SQFT	2,455	5.20	12,766.00
32	840656	PAINT TRAFFIC STRIPE (2-COAT)	LF	65,000	0.46	29,900.00
33	846051	12" RUMBLE STRIP (ASPHALT CONCRETE PAVEMENT)	STA	43	218.00	9,374.00
34	870111	INDUCTIVE LOOP DETECTOR (EA)	EA	26	295.00	7,410.00
35	010602	MISCELLANEOUS WORK (AS DIRECTED)	FA	1	207,000.00	207,000.00

BASE BID SCH.

SUB-TOTAL: One million nine hundred sixty-eight thousand eight hundred thirty-nine dollars and zero cents \$1,968,839.00
ITEMS 1-35 "WORDS"

ALTERNATE BID SCHEDULE 1: Western Municipal Water District (WMWD) Facilities Adjustments

36	710200	ADJUST MANHOLE	EA	38	880.00	34,160.00
----	--------	----------------	----	----	--------	-----------

ALTERNATE BID SCH. 1

SUB-TOTAL: Thirty-three thousand four hundred forty dollars and zero cents \$33,440.00
ITEM 36 "WORDS"

ALTERNATE BID SCHEDULE 2 - City of Riverside Facilities Adjustments

37	710200	ADJUST MANHOLE	EA	7	880.00	6,160.00
----	--------	----------------	----	---	--------	----------

ALTERNATE BID SCH. 2

SUB-TOTAL: Six thousand one hundred sixty dollars and zero cents \$6,160.00
ITEM 37 "WORDS"

BASE BID SCHEDULES and ALTERNATE BID SCHEDULES 1 and 2

PROJECT TOTAL: Two million eight thousand four hundred thirty-nine dollars and zero cents \$2,008,439.00
ITEMS 1-37 "WORDS"

Bidder Data and Signature

Name of Bidder: All American Asphalt

Type of organization: Corporation

Person(s) authorized to sign for Bidder: Mark Luer, President

Edward J. Carlson, Vice President

Michael Farkas, Secretary

Note:

If Bidder is a **Corporation**, state legal name of Corporation and also names of the president, vice-president, secretary, treasurer and manager thereof.

If Bidder is a **Co-Partnership**, state true name of firm and also names of all individual co-partners composing firm.

If Bidder is a sole proprietorship or an **Individual**, state first and last name(s) in full.

If Bid is signed by an agent other than an owner, partner or corporate officer, Bid shall be accompanied by a power-of-attorney.

Business Street Address: 400 E. Sixth Street
(Please include business address even if P.O. Box is used.)

Business City, State, Zip Code: Corona, CA 92879

P.O. Box- Number: P.O. Box 2229

P.O. Box- City, State, Zip Code: Corona, CA 92878

Phone: (951) 736-7600

Facsimile: (951) 736-7646

E-mail: publicworks@allamericanasphalt.com

Contractor's license number: 267073

License Classification(s): A, C-12

Expiration date: 1-31-2020

Department of Industrial Relations Registration Number: 1000001051

Bidder Data and Signature (continued)

Accompanying this Bid is a certified check, cashier check or bid bond in an amount equal to at least ten (10) percent of the total bid for:

La Sierra Avenue Resurfacing Project
El Sobrante Road to County of Riverside/City of Riverside Boundary
Community of Lake Hills
Project No. C6-0074

By my signature on this Bid, I certify, under penalty of perjury under the laws of the State of California, that all the information on this form is true and correct.

IN WITNESS WHERE OF Bidder/Contractor executed this Bid as of the date set forth on page **B1** of this Bid.

Signature:



Name (printed):

Edward J. Carlson

Title:

Vice President

"Contractor"

Subcontractor List

Bidder/Contractor submits the following complete list of each Subcontractor who will perform work, labor or render service in or about the construction in an amount in excess of 1/2 of 1% of the total bid or \$10,000 whichever is greater.

Check box on right side of row if any construction item, for the listed Subcontractor, is partial work. If partial work is to be performed within a certain construction item or trade, the Bidder/Contractor shall specify the portion(s) of the work to be performed by the different subcontractors or Bidder/Contractor will be subject to provisions of Public Contract Code Section 4106.

Name of Bidder (Prime/General Contractor): All American Asphalt

	Subcontractor Name	License Number	DIR Registration Number	Business Address (City, State)	Construction Item(s) [Item Number and Description]	Check if Partial Work
1.	Belco Electric	738518	1000004864	Chino, CA	6, 7, 8, 9, 34 Electrical	<input type="checkbox"/>
2.	Superior Pavement Markings.	776306	1000001476	Beaumont, CA	26, 27, 28, 29, 30, 31, 32 Signing & Striping	<input type="checkbox"/>
3.	AC Dike CO	407417	1000008929	Lincoln CA	11, 14, 15 Place Dike	<input type="checkbox"/>
4.	Pavement Recycling Systems	569352	1000003363	Jurupa Valley CA	33 Rumble Strip	<input type="checkbox"/>
5.						<input type="checkbox"/>
6.						<input type="checkbox"/>

Additional Subcontractor List(s) may be attached to the Bid.
(A copy of this form may be attached with additional Subcontractor information.)

Percent of work to be performed by Subcontractors: 11.8 %

Note: A minimum of 50% of the work is required to be performed by the prime/general Contractor.

Non-Collusion Declaration

To be executed by bidder and submitted with bid.
(Title 23 United States Code Section 112 and Public Contract Code Section 7106)

The undersigned declares:

I am the Vice President (Title) of All American Asphalt (Company),
the party making the foregoing bid.

The bid is not made in the interest of, or on behalf of, any undisclosed person, partnership, company, association, organization, or corporation. The bid is genuine and not collusive or sham. The bidder has not directly or indirectly induced or solicited any other bidder to put in a false or sham bid. The bidder has not directly or indirectly colluded, conspired, connived, or agreed with any bidder or anyone else to put in a sham bid, or that anyone shall refrain from bidding. The bidder has not in any manner, directly or indirectly, sought by agreement, communication, or conference with anyone to fix the bid price of the bidder or any other bidder, or to fix any overhead, profit, or cost element of the bid price, or of that of any other bidder.

All statements contained in the bid are true. The bidder has not, directly or indirectly, submitted his or her bid price of any breakdown thereof, or the contents thereof, or divulged information or data relative thereto, to any corporation, partnership, company, association, organization, bid depository, or to any member or agent thereof to effectuate a collusive or sham bid, and has not paid, and will not pay, any person or entity for such purpose.

Any person executing this declaration on behalf of a bidder that is a corporation, partnership, joint venture, limited liability company, limited liability partnership, or any other entity, hereby represents that he or she has full power to execute, and does execute, this declaration on behalf of the bidder.

I declare under penalty of perjury under the applicable laws that the foregoing is true and correct and that this declaration is executed on

August (Month) 15th (Day) of 2018 (Year),

at Corona (City), CA (State).

Signature of Declarant:

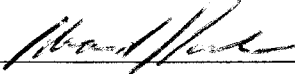

Printed name of Declarant:

Edward J. Carlson

Name of Bidder (Company):

All American Asphalt

Title or Office:

Vice President

Note: Notarization of signature required.



Check box if attachment is included.

CALIFORNIA ALL-PURPOSE ACKNOWLEDGEMENT

CIVIL CODE § 1189

A notary public or other officer completing this certificate verifies only the identity of the individual who signed the document to which this certificate is attached, and not the truthfulness, accuracy, or validity of that document.

State of California

County of Riverside

On August 15, 2018 before me, Courtney Chapas, Notary Public
Date Here Insert name and Title of the Officer

personally appeared Edward J. Carlson
Name(s) of Signer(s)

who proved to me on the basis of satisfactory evidence to be the person(s) whose name(s) is/are subscribed to the within instrument and acknowledged to me that he/~~she~~/they executed the same in his/~~her~~/their authorized capacity(ies), and that by his/~~her~~/their signature(s) on the instrument the person(s), or the entity upon behalf of which the person(s) acted, executed the instrument.

I certify under PENALTY OF PERJURY under the laws of the State of California that the forgoing paragraph is true and correct.

WITNESS my hand and official seal.

Signature Courtney Chapas
Signature of Notary Public

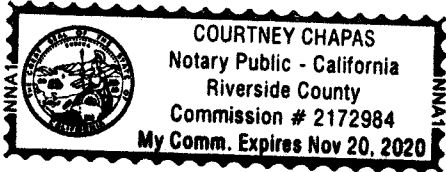

Place Notary Seal Above

OPTIONAL

Though the information below is not required by law, it may prove valuable to person relying on the document and could prevent fraudulent removal and reattachment of this form to another document.

Description of Attached Document

Title or Type of Document Non-Collusion Declaration

Document Date: August 15, 2018 Number of Pages: 1

Signer(s) Other Than Named Above: None

Capacity(ies) Claimed by Signer(s)

Signer's Name: Edward J. Carlson

- Individual
- Corporate Officer — Title(s): Vice President
- Partner Limited General
- Attorney in Fact
- Trustee
- Other: _____

Signer is Representing:
All American Asphalt

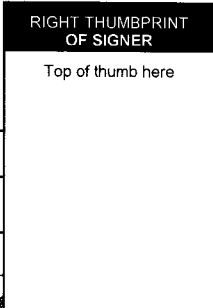

Signer's Name: _____

- Individual
- Corporate Officer — Title(s): _____
- Partner Limited General
- Attorney in Fact
- Trustee
- Other: _____

Signer is Representing:
All American Asphalt

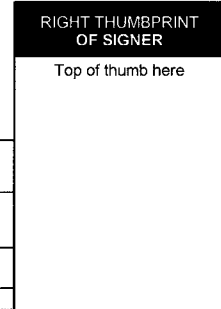

Iran Contracting Act
(Public Contract Code sections 2200-2208)

Prior to bidding on, submitting a proposal or executing a contract or renewal for a County of Riverside contract for goods or services of **\$1,000,000 or more**, a Contractor must either:

- a) Certify it is not on the current list of persons engaged in investment activities in Iran created by the California Department of General Services ("DGS") pursuant to Public Contract Code section 2203(b) and is not a financial institution extending twenty million dollars (\$20,000,000) or more in credit to another person, for 45 days or more, if that other person will use the credit to provide goods or services in the energy sector in Iran and is identified on the current list of persons engaged in investment activities in Iran created by DGS; or
- b) Demonstrate it has been exempted from the certification requirement for that solicitation or contract pursuant to Public Contract Code section 2203(c) or (d).

To comply with this requirement, please insert your Contractor or financial institution name and Federal ID Number (if available) and complete one of the options below. Please note: California law establishes penalties for providing false certifications, including civil penalties equal to the greater of \$250,000 or twice the amount of the contract for which the false certification was made; contract termination; and three-year ineligibility to bid on contracts. (Public Contract Code section 2205.)

Option #1 – Certification

I, the official named below, certify I am duly authorized to execute this certification on behalf of the vendor/financial institution identified below, and the vendor/financial institution identified below is **not** on the current list of persons engaged in investment activities in Iran created by DGS and is not a financial institution extending twenty million dollars (\$20,000,000) or more in credit to another person/vendor, for 45 days or more, if that other person/vendor will use the credit to provide goods or services in the energy sector in Iran and is identified on the current list of persons engaged in investment activities in Iran created by DGS.

<i>Contractor Name/Financial Institution (Printed)</i> All American Asphalt		<i>Federal ID Number (or n/a)</i> 95-2595043	
<i>By (Authorized Signature)</i> 			
<i>Printed Name and Title of Person Signing</i> Edward J. Carlson, Vice President			
<i>Date Executed</i> 08/15/2018		<i>Executed in</i> Corona, CA	

Option #2 – Exemption

Pursuant to Public Contract Code sections 2203(c) and (d), a public entity may permit a Contractor/financial institution engaged in investment activities in Iran, on a case-by-case basis, to be eligible for, or to bid on, submit a proposal for, or enters into or renews, a contract for goods and services.

If you have obtained an exemption from the certification requirement under the Iran Contracting Act, please fill out the information below, and **attach documentation demonstrating the exemption approval.**

<i>Contractor Name/Financial Institution (Printed)</i>		<i>Federal ID Number (or n/a)</i>	
<i>By (Authorized Signature)</i>			
<i>Printed Name and Title of Person Signing</i>			
<i>Date Executed</i>		<i>Executed in</i>	

COPY

Bid Bond

Recitals:

1. All American Asphalt "Contractor", has submitted his/her Contractor's Proposal to County of Riverside, "County", for the construction of public work for La Sierra Avenue Resurfacing Project, El Sobrante Road to County of Riverside/ City of Riverside Boundary, Community of Lake Hills, Project No. C6-0074 in accordance with a Notice Inviting Bids from the County.
2. Fidelity and Deposit Company of Maryland a Maryland corporation, hereafter called "Surety", is the surety of this bond.

Agreement:

We, Contractor as Principal and Surety as Surety, jointly and severally agree and state as follows:

1. The amount of the obligation of this bond is 10% of the amount of the Contractor's Proposal, including bid alternates, and inures to the benefit of County.
2. This Bond is exonerated by (1) County rejecting said Proposal or, in the alternate, (2) if said Proposal is accepted, Contractor executes the Contract and furnishes the Bonds as agreed to in its Proposal, otherwise it remains in full force and effect for the recovery of loss, damage and expense of County resulting from failure of Contractor to act as agreed to in its Proposal. Some types of possible loss, damage and expense are specified in the Contractor's Proposal.
3. Surety, for value received, stipulates and agrees that its obligations hereunder shall in no way be impaired or affected by any extension of time within which County may accept the Proposal and waives notice of any such extension.
4. This Bond is binding on our heirs, executors, administrators, successors and assigns.

Dated: August 14, 2018

Signatures:

<u>Fidelity and Deposit Company of Maryland</u>	<u>All American Asphalt</u>
By: <u>Rebecca Haas-Bates</u>	By: <u>[Signature]</u>
Title: Attorney in Fact	Title: <u>Edward J. Carlson, Vice President</u>
"Surety"	"Contractor"

STATE OF **Please See Attached**
COUNTY _____ }
OF _____

ss. SURETY'S ACKNOWLEDGEMENT

On _____ before me, _____ personally appeared, _____ known to me, or proved to me on the basis of satisfactory evidence, to be the person whose name is subscribed to the within instrument and acknowledged to me that he/she executed the same in his/her authorized capacities, and that by his/her signature on the instrument the person, or the entity upon behalf of which the person acted, executed the instrument.

WITNESS my hand and official seal.

_____ Signature of Notary Public	_____ Notary Public (Seal)
-------------------------------------	-------------------------------

Note: This Bond must be executed by both Contractor and Surety with corporate seal affixed. All signatures must be notarized. (Attach acknowledgements).

CALIFORNIA ALL-PURPOSE ACKNOWLEDGEMENT

CIVIL CODE § 1189

COPY

A notary public or other officer completing this certificate verifies only the identity of the individual who signed the document to which this certificate is attached, and not the truthfulness, accuracy, or validity of that document.

State of California

County of Riverside

On August 15, 2018 before me, Courtney Chapas, Notary Public
Date Here Insert name and Title of the Officer

personally appeared Edward J. Carlson
Name(s) of Signer(s)

who proved to me on the basis of satisfactory evidence to be the person(s) whose name(s) is/are subscribed to the within instrument and acknowledged to me that he/she/they executed the same in his/her/their authorized capacity(ies), and that by his/her/their signature(s) on the instrument the person(s), or the entity upon behalf of which the person(s) acted, executed the instrument.

I certify under PENALTY OF PERJURY under the laws of the State of California that the foregoing paragraph is true and correct.

WITNESS my hand and official seal.

Signature Courtney Chapas
Signature of Notary Public

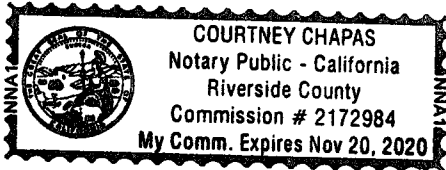

Place Notary Seal Above

OPTIONAL

Though the information below is not required by law, it may prove valuable to person relying on the document and could prevent fraudulent removal and reattachment of this form to another document.

Description of Attached Document

Title or Type of Document Bid Bond

Document Date: August 14, 2018 Number of Pages: 1

Signer(s) Other Than Named Above: None

Capacity(ies) Claimed by Signer(s)

Signer's Name: Edward J. Carlson

- Individual
- Corporate Officer — Title(s): Vice President
- Partner Limited General
- Attorney in Fact
- Trustee
- Other: _____

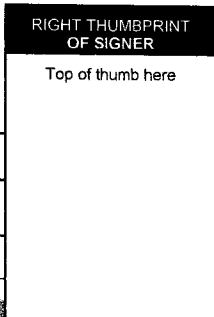

Signer is Representing:
All American Asphalt

Signer's Name: _____

- Individual
- Corporate Officer — Title(s): _____
- Partner Limited General
- Attorney in Fact
- Trustee
- Other: _____

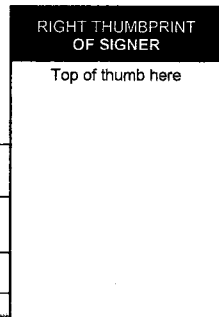

Signer is Representing:
All American Asphalt

CALIFORNIA ALL-PURPOSE ACKNOWLEDGMENT

CIVIL CODE § 1189

COPY

A notary public or other officer completing this certificate verifies only the identity of the individual who signed the document to which this certificate is attached, and not the truthfulness, accuracy, or validity of that document.

State of California)
County of Orange)

On 08/14/2018 before me, A. MacFarlane, Notary Public
Date Here Insert Name and Title of the Officer

personally appeared Rebecca Haas-Bates
Name(s) of Signer(s)

who proved to me on the basis of satisfactory evidence to be the person(s) whose name(s) is/are subscribed to the within instrument and acknowledged to me that he/she/they executed the same in his/her/their authorized capacity(ies), and that by his/her/their signature(s) on the instrument the person(s), or the entity upon behalf of which the person(s) acted, executed the instrument.

I certify under PENALTY OF PERJURY under the laws of the State of California that the foregoing paragraph is true and correct.

WITNESS my hand and official seal.

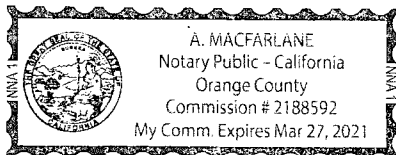

Signature [Signature]
Signature of Notary Public

Place Notary Seal Above

OPTIONAL

Though this section is optional, completing this information can deter alteration of the document or fraudulent reattachment of this form to an unintended document.

Description of Attached Document

Title or Type of Document: Bid Bond Document Date: 08/14/2018
Number of Pages: One (1) Signer(s) Other Than Named Above: All American Asphalt

Capacity(ies) Claimed by Signer(s)

Signer's Name: Rebecca Haas-Bates
 Corporate Officer — Title(s): _____
 Partner — Limited General
 Individual Attorney in Fact
 Trustee Guardian or Conservator
 Other: _____
Signer Is Representing: _____
Fidelity and Deposit Company of Maryland _____

Signer's Name: _____
 Corporate Officer — Title(s): _____
 Partner — Limited General
 Individual Attorney in Fact
 Trustee Guardian or Conservator
 Other: _____
Signer Is Representing: _____

EXTRACT FROM BY-LAWS OF THE COMPANIES

"Article V, Section 8, Attorneys-in-Fact. The Chief Executive Officer, the President, or any Executive Vice President or Vice President may, by written instrument under the attested corporate seal, appoint attorneys-in-fact with authority to execute bonds, policies, recognizances, stipulations, undertakings, or other like instruments on behalf of the Company, and may authorize any officer or any such attorney-in-fact to affix the corporate seal thereto; and may with or without cause modify or revoke any such appointment or authority at any time."

CERTIFICATE

I, the undersigned, Vice President of the ZURICH AMERICAN INSURANCE COMPANY, the COLONIAL AMERICAN CASUALTY AND SURETY COMPANY, and the FIDELITY AND DEPOSIT COMPANY OF MARYLAND, do hereby certify that the foregoing Power of Attorney is still in full force and effect on the date of this certificate; and I do further certify that Article V, Section 8, of the By-Laws of the Companies is still in force.

This Power of Attorney and Certificate may be signed by facsimile under and by authority of the following resolution of the Board of Directors of the ZURICH AMERICAN INSURANCE COMPANY at a meeting duly called and held on the 15th day of December 1998.

RESOLVED: "That the signature of the President or a Vice President and the attesting signature of a Secretary or an Assistant Secretary and the Seal of the Company may be affixed by facsimile on any Power of Attorney...Any such Power or any certificate thereof bearing such facsimile signature and seal shall be valid and binding on the Company."

This Power of Attorney and Certificate may be signed by facsimile under and by authority of the following resolution of the Board of Directors of the COLONIAL AMERICAN CASUALTY AND SURETY COMPANY at a meeting duly called and held on the 5th day of May, 1994, and the following resolution of the Board of Directors of the FIDELITY AND DEPOSIT COMPANY OF MARYLAND at a meeting duly called and held on the 10th day of May, 1990.

RESOLVED: "That the facsimile or mechanically reproduced seal of the company and facsimile or mechanically reproduced signature of any Vice-President, Secretary, or Assistant Secretary of the Company, whether made heretofore or hereafter, wherever appearing upon a certified copy of any power of attorney issued by the Company, shall be valid and binding upon the Company with the same force and effect as though manually affixed.

IN TESTIMONY WHEREOF, I have hereunto subscribed my name and affixed the corporate seals of the said Companies, this 14th day of August, 2018.



Michael Bond

Michael Bond, Vice President

TO REPORT A CLAIM WITH REGARD TO A SURETY BOND, PLEASE SUBMIT ALL REQUIRED INFORMATION TO:

Zurich American Insurance Co.
Attn: Surety Claims
1299 Zurich Way
Schaumburg, IL 60196-1056

COPY

**ZURICH AMERICAN INSURANCE COMPANY
COLONIAL AMERICAN CASUALTY AND SURETY COMPANY
FIDELITY AND DEPOSIT COMPANY OF MARYLAND
POWER OF ATTORNEY**

COPY

KNOW ALL MEN BY THESE PRESENTS: That the ZURICH AMERICAN INSURANCE COMPANY, a corporation of the State of New York, the COLONIAL AMERICAN CASUALTY AND SURETY COMPANY, a corporation of the State of Maryland, and the FIDELITY AND DEPOSIT COMPANY OF MARYLAND a corporation of the State of Maryland (herein collectively called the "Companies"), by **DAVID MCVICKER, Vice President**, in pursuance of authority granted by Article V, Section 8, of the By-Laws of said Companies, which are set forth on the reverse side hereof and are hereby certified to be in full force and effect on the date hereof, do hereby nominate, constitute, and appoint **William SYRKIN, Rebecca HAAS-BATES, Sergio D. BECHARA and Richard ADAIR, all of Irvine, California, EACH** its true and lawful agent and Attorney-in-Fact, to make, execute, seal and deliver, for, and on its behalf as surety, and as its act and deed: **any and all bonds and undertakings**, and the execution of such bonds or undertakings in pursuance of these presents, shall be as binding upon said Companies, as fully and amply, to all intents and purposes, as if they had been duly executed and acknowledged by the regularly elected officers of the ZURICH AMERICAN INSURANCE COMPANY at its office in New York, New York., the regularly elected officers of the COLONIAL AMERICAN CASUALTY AND SURETY COMPANY at its office in Owings Mills, Maryland., and the regularly elected officers of the FIDELITY AND DEPOSIT COMPANY OF MARYLAND at its office in Owings Mills, Maryland., in their own proper persons.

The said Vice President does hereby certify that the extract set forth on the reverse side hereof is a true copy of Article V, Section 8, of the By-Laws of said Companies, and is now in force.

IN WITNESS WHEREOF, the said Vice-President has hereunto subscribed his/her names and affixed the Corporate Seals of the said **ZURICH AMERICAN INSURANCE COMPANY, COLONIAL AMERICAN CASUALTY AND SURETY COMPANY, and FIDELITY AND DEPOSIT COMPANY OF MARYLAND**, this 10th day of July, A.D. 2017.

ATTEST:

**ZURICH AMERICAN INSURANCE COMPANY
COLONIAL AMERICAN CASUALTY AND SURETY COMPANY
FIDELITY AND DEPOSIT COMPANY OF MARYLAND**



By: *Dawn E. Brown*
*Assistant Secretary
Dawn E. Brown*

David McVicker
*Vice President
David McVicker*

State of Maryland
County of Baltimore

On this 10th day of July, A.D. 2017, before the subscriber, a Notary Public of the State of Maryland, duly commissioned and qualified, **DAVID MCVICKER, Vice President, and DAWN E. BROWN, Assistant Secretary**, of the Companies, to me personally known to be the individuals and officers described in and who executed the preceding instrument, and acknowledged the execution of same, and being by me duly sworn, depose and saith, that he/she is the said officer of the Company aforesaid, and that the seals affixed to the preceding instrument are the Corporate Seals of said Companies, and that the said Corporate Seals and the signature as such officer were duly affixed and subscribed to the said instrument by the authority and direction of the said Corporations.

IN TESTIMONY WHEREOF, I have hereunto set my hand and affixed my Official Seal the day and year first above written.

Constance A. Dunn



Constance A. Dunn, Notary Public
My Commission Expires: July 9, 2019



COPY

- Company Profile
- Company Search
- Company Information
- Old Company Names
- Agent for Service
- Reference Information
- NAIC Group List
- Lines of Business
- Workers' Compensation Complaint and Request for Action/Appeals Contact Information
- Financial Statements PDF's
- Annual Statements
- Quarterly Statements
- Company Complaint
- [Company Performance & Comparison Data](#)
- Company Enforcement Action
- Composite Complaints Studies
- Additional Info
- Find A Company Representative In Your Area
- View Financial Disclaimer

COMPANY PROFILE

Company Information

FIDELITY AND DEPOSIT COMPANY OF MARYLAND

1299 ZURICH WAY
SCHAUMBURG, IL 60196
800-382-2150

Old Company Names

Effective Date

Agent For Service

KARISSA LOWRY
2710 GATEWAY OAKS DRIVE
SUITE 150N
SACRAMENTO CA 95833

Reference Information

NAIC #:	39306
California Company ID #:	2479-4
Date Authorized in California:	01/01/1982
License Status:	UNLIMITED-NORMAL
Company Type:	Property & Casualty
State of Domicile:	MARYLAND

[back to top](#)

NAIC Group List

NAIC Group #: 0212 ZURICH INS GRP

Lines Of Business

The company is authorized to transact business within these lines of insurance. For an explanation of any of these terms, please refer to the glossary.

- AIRCRAFT
- AUTOMOBILE
- BOILER AND MACHINERY
- BURGLARY
- CREDIT
- FIRE
- LIABILITY
- MARINE
- MISCELLANEOUS
- PLATE GLASS
- SPRINKLER
- SURETY
- TEAM AND VEHICLE
- WORKERS' COMPENSATION

[back to top](#)



Patricia Romo, P.E.
Director of Transportation

COUNTY OF RIVERSIDE

TRANSPORTATION AND LAND MANAGEMENT AGENCY

Mojahed Salama, P.E.
Deputy for Transportation/Capital Projects
Richard Lantis, P.L.S.
Deputy for Transportation/Planning and
Development

Transportation Department

ADDENDUM NUMBER 1

Dated August 17, 2018

to the
Specifications and Contract Documents
for the construction of

La Sierra Avenue Resurfacing Project
El Sobrante Road to County of Riverside/City of Riverside Boundary
Community of Lake Hills
Project No. C6-0074

Bids Due: Wednesday, August 22, 2018; 2:00 p.m.
14th Street Transportation Annex
3525 14th Street; Riverside, CA 92501
(951) 955-6780

This Addendum is issued pursuant to the Instructions to Bidders, Item No. 8, of the Contract Documents for the reference project. This Addendum is issued as a supplement to the specification and special provisions for the referenced project. The revisions to the specifications shall become a part of the Contract Documents, and each bidder shall acknowledge receipt thereof on the Bid (Proposal). Bidders are directed to sign this addendum as acknowledged and attach the signed addendum to the contractor's submitted proposal.

Note: During the advertisement period of this project, this document and attachments (if any) are available upon request at the office of the Transportation Department, and are available as a free download at the Transportation Department's website:

<http://rctlma.org/trans/Contractors-Corner/Notices-Inviting-Bids>

MODIFICATIONS / CLARIFICATIONS TO SPECIAL PROVISIONS:

Item 1: Revised Proposal. Refer to "Proposal" pages B2 and B3. Delete and replace "Proposal" (pages B2 and B3) with "Proposal (Revised)" attached herewith as **Attachment "A"**.

- a. "Estimated Quantities" are revised from the following bid items:
 - Item 14, "RUBBERIZED HOT MIX ASPHALT (GAP GRADED)"
 - Item 16, "COLD PLANE ASPHALT CONCRETE PAVEMENT"
 - Item 36, "ADJUST MANHOLE"

Addendum No. 1

La Sierra Avenue Resurfacing Project

El Sobrante Road to County of Riverside/City of Riverside Boundary, Community of Lake Hills

Project No. C6-0074

August 17, 2018

Page 2 of 3

b. Alternative Bid Item No. 2 has been replaced by City of Riverside Manholes Adjustments:

Item 37 "ADJUST MANHOLE"

c. Items 18 through 21 have been deleted.

MODIFICATIONS / CLARIFICATIONS TO THE PLANS

Item 2: Plan sheet revisions. The following Plan sheets are revised by **Attachment "B"** and made a part hereby:

Delete and replace the following eight (8) plan sheets:

1. Plan sheet 10 of 20, L-7
2. Plan sheet 11 of 20, L-8
3. Plan sheet 13 of 20, PD-1
4. Plan sheet 14 of 20, PD-2
5. Plan sheet 15 of 20, PD-3
6. Plan sheet 16 of 20, PD-4
7. Plan sheet 17 of 20, PD-5
8. Plan sheet 18 of 20, PD-6

Note: All revised plan sheets are posted on the County website and are available for download during the advertisement period.

<http://rctlma.org/trans/Contractors-Corner/Notices-Inviting-Bids>

ATTACHMENTS

A – Revised Proposal

B – Revised Plan Sheets (8)

This addendum has been prepared under the direction of the following registered Civil Engineer(s):

Recommended by:

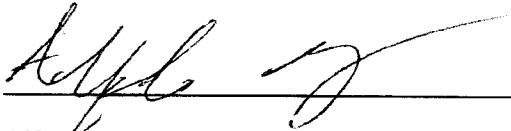

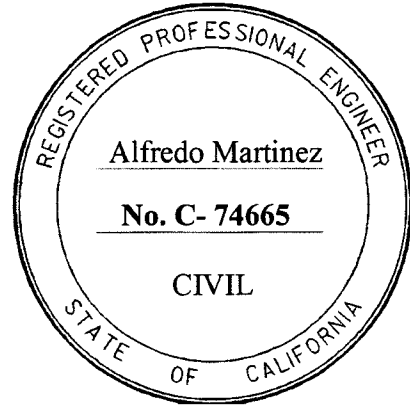
8/17/18
Alfredo Martinez, PE
County Project Manager

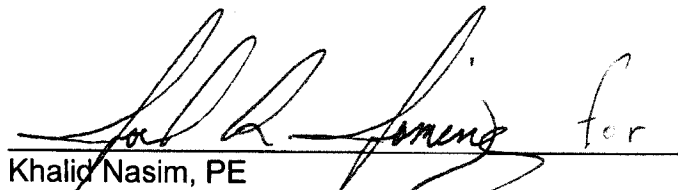

Concurrence:

for 8/17/18
Khalid Nasim, PE
Engineering Division Manager

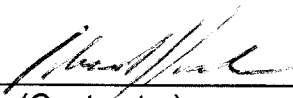
Acknowledged:

(Contractor)
Edward J. Carlson, Vice President

Date: 8/20/2018

JRJ:jjr:rr

Note: Refer to Instruction to Bidders Item No. 8, "Addenda". Submission of all addendum pages and non-bidding document attachments of addendum are not necessary for Bid submittal. Submittal of this acknowledgement page is adequate for Bid reception. Bidders are reminded to list addendum number(s) received on the first page of the Bid form (Proposal).

Contract

THIS CONTRACT is entered into at Riverside, California as of the date set forth below is between County of Riverside hereafter called "County" and All American Asphalt, hereafter called "Contractor".

WITNESSETH

Recitals:

1. Contractor has submitted to County his Contractor's Proposal for the construction of County Project, La Sierra Avenue Resurfacing Project, El Sobrante Road to County of Riverside/ City of Riverside Boundary, Community of Lake Hills, Project No. C6-0074, in strict accordance with the Contract Documents identified below and County has accepted said Proposal.
2. Contractor states that he has reexamined his Contractor's Proposal and found it to be correct, has ascertained that his subcontractors are properly licensed and possess the requisite skill and forces, has reexamined the site and Contract Documents and is of the opinion that he can presently do the work in accordance with the Contract Documents for the money set forth in his Proposal to be paid as provided in the Contract Documents.

Agreement:

It is agreed by the parties as follows:

1. Contract Documents

The entire Contract consists of the following: (a) The Construction Contract, (b) The Notice to Bidders. (c) The Instruction to Bidders, (d) The Bid, (e) The Bid Bond, (f) The Payment Bond, (g) The Performance Bond, (h) The General Conditions, (i) The Special Provisions, (j) The Standard Specifications of the State of California Department of Transportation edition of 2015 as modified in other portions of the Contract Documents and as amended by the State of California Department of Transportation, (k) The Standard Plans of the Department of Transportation identified on the plans or in the Special Provisions, (l) The Plans, (m) Addenda, (n) The Determination of Prevailing Wage Rates for Public Works, (o) Any Change Orders issued, and (p) Any additional or supplemental specifications, notice, instructions and drawings issued in accordance with the provisions of the Contract Documents. All of said Documents presently in existence are by this reference incorporated herein with like effect as if here set forth in full and upon the proper issuance of other documents they shall likewise be deemed incorporated. The Bid Bond is exonerated upon execution of this Contract and the Payment Bond and Performance Bond.

2. The Work

Contractor shall do all tasks necessary to construct the work generally described in Recital No. 1 in accordance with the Contract Documents.

3. Prosecution, Progress and Liquidated Damages

Attention is directed to the provisions in Section 8-1.04, "Start of Job Site Activities", Section 8-1.05, "Time", and in Section 8-1.10 "Liquidated Damages" of the Standard Specifications and these Special Provisions.

Standard Specification Section 8-1.04B, "Standard Start" is modified to read as follows:

The Contractor shall begin work within fifteen (15) calendar days, or as revised in the Special Provisions, of the date stated within the written "Notice to Proceed".

The Contractor shall notify the Engineer, in writing, of the Contractor's intent to begin work at least 72 hours before work is begun. If the project has more than one (1) location of work, Contractor shall submit a separate notice for each location. The notice shall be delivered to the Transportation Department's Construction Engineer and shall specify the date the Contractor intends to start at said location.

Should the Contractor begin work in advance of receiving a written "Notice to Proceed", any work performed by the Contractor in advance of the date stated in the "Notice to Proceed" shall be considered as having been done by the Contractor at his own risk and as a volunteer and subject to the following:

- A. The Contractor shall, on commencing operations, take all precautions required for public safety and shall observe all the provisions in the Specifications and the Special Provisions.
- B. All work done according to the Contract, prior to the issuance of the "Notice to Proceed", will be considered authorized work and will be paid for as provided in the contract.
- C. The Contractor shall not be entitled to any additional compensation or an extension of time for any delay, hindrance or interference caused by or attributable to commencement of work prior to the issuance of the "Notice to Proceed".

4. Compensation

Contractor shall be paid in the manner set forth in the Contract Documents the amount of his Proposal as accepted by County, the above rates, subject to additions and deductions as provided in the Contract Documents. Said Proposal is on file in the Office of the Clerk of the Board of Supervisors of County.

La Sierra Avenue Resurfacing Project
El Sobrante Road to County of Riverside/City of Riverside Boundary
Community of Lake Hills
Project No. C6-0074

Contract

BASE BID SCHEDULE: LA SIERRA AVENUE RESURFACING PROJECT

ITEM No.	ITEM CODE	ITEM	UNIT	ESTIMATED QUANTITY	ITEM PRICE (IN FIGURES)	TOTAL (IN FIGURES)
1	100100	DEVELOP WATER SUPPLY	LS	1	1,465.00	1,465.00
2	120100	TRAFFIC CONTROL SYSTEM	LS	1	59,400.00	59,400.00
3	130200	PREPARE WATER POLLUTION CONTROL PROGRAM	LS	1	1,250.00	1,250.00
4	170103	CLEARING AND GRUBBING (LS)	LS	1	10,500.00	10,500.00
5	066100	DUST ABATEMENT	LS	1	9,600.00	9,600.00
6	860201	SIGNAL AND LIGHTING (BLACKBURN RD)	LS	1	33,150.00	33,150.00
7	860201	SIGNAL AND LIGHTING (LAKE CREST DR)	LS	1	33,150.00	33,150.00
8	860201	SIGNAL AND LIGHTING (LAKE KNOLL PKWY)	LS	1	33,150.00	33,150.00
9	860201	SIGNAL AND LIGHTING (MCALLISTER PKWY)	LS	1	33,150.00	33,150.00
10	013902	ASPHALT CONCRETE OVERSIDE DRAIN (CRS 306)	EA	10	363.00	3,630.00
11	013903	PLACE ASPHALT CONCRETE DIKE (CRS 212) (6")	LF	13,035	1.70	22,159.50
12	013908	ASPHALT CONCRETE DRIVEWAY	SQFT	1,155	9.20	10,626.00
13	390132	HOT MIX ASPHALT (TYPE A)	TON	520	65.50	34,060.00
14	390137	RUBBERIZED HOT MIX ASPHALT (GAP GRADED)	TON	10,105	90.50	914,502.50
15	394074	PLACE HOT MIX ASPHALT DIKE (TYPE C)	LF	580	1.70	986.00
16	398200	COLD PLANE ASPHALT CONCRETE PAVEMENT	SQYD	88,440	1.95	172,458.00
17	510501	MINOR CONCRETE	CY	3	900.00	2,700.00
18	000001	ITEM DELETED PER ADDENDUM No. 1	-----	-----	-----	-----
19	000001	ITEM DELETED PER ADDENDUM No. 1	-----	-----	-----	-----
20	000001	ITEM DELETED PER ADDENDUM No. 1	-----	-----	-----	-----
21	000001	ITEM DELETED PER ADDENDUM No. 1	-----	-----	-----	-----
22	017302	MINOR CONCRETE (CROSS-GUTTER) (CRS 209)	SQFT	4,375	23.00	100,625.00
23	017303	MINOR CONCRETE (SPANDREL) (CRS 209)	SQFT	5,315	22.00	116,930.00
24	017315	MINOR CONCRETE (CURB RAMP) (CRS 403 - CASE A)	EA	15	5,100.00	76,500.00
25	017316	MINOR CONCRETE (CURB RAMP) (CRS 403 - CASE B)	EA	1	5,600.00	5,600.00
26	810230	PAVEMENT MARKER (RETROREFLECTIVE)	EA	1,702	4.00	6,808.00
27	820130	OBJECT MARKER	EA	25	57.00	1,425.00
28	820410	SALVAGE ROADSIDE SIGN	EA	47	41.00	1,927.00
29	820840	ROADSIDE SIGN - ONE POST	EA	46	311.00	14,306.00
30	820850	ROADSIDE SIGN - TWO POST	EA	3	777.00	2,331.00
31	840519	THERMOPLASTIC CROSSWALK AND PAVEMENT MARKING	SQFT	2,455	5.20	12,766.00

Contract (continued)

BASE BID SCHEDULE: LA SIERRA AVENUE RESURFACING PROJECT

ITEM No.	ITEM CODE	ITEM	UNIT	ESTIMATED QUANTITY	ITEM PRICE (IN FIGURES)	TOTAL (IN FIGURES)
32	840656	PAINT TRAFFIC STRIPE (2-COAT)	LF	65,000	0.46	29,900.00
33	846051	12" RUMBLE STRIP (ASPHALT CONCRETE PAVEMENT)	STA	43	218.00	9,374.00
34	870111	INDUCTIVE LOOP DETECTOR (EA)	EA	26	285.00	7,410.00
35	010602	MISCELLANEOUS WORK (AS DIRECTED)	FA	1	207,000.00	207,000.00

BASE BID SCHEDULE One million, nine hundred sixty eight thousand, eight hundred thirty nine dollars and zero cents **\$ 1,968,839.00**
ITEMS 1-35 "WORDS"

ALTERNATE BID SCHEDULE 1 – WESTERN MUNICIPAL WATER DISTRICT (WMWD) FACILITIES ADJUSTMENTS

ITEM No.	ITEM CODE	ITEM	UNIT	ESTIMATED QUANTITY	ITEM PRICE (IN FIGURES)	TOTAL (IN FIGURES)
36	710200	ADJUST MANHOLE	EA	38	880.00	33,440.00

ALTERNATE BID No. 1 Thirty three thousand, four hundred forty dollars and zero cents **\$ 33,440.00**
ITEM 36 "WORDS"

ALTERNATE BID SCHEDULE 2 – CITY OF RIVERSIDE FACILITIES ADJUSTMENTS

ITEM No.	ITEM CODE	ITEM	UNIT	ESTIMATED QUANTITY	ITEM PRICE (IN FIGURES)	TOTAL (IN FIGURES)
37	710200	ADJUST MANHOLE	EA	7	880.00	6,160.00

ALTERNATE BID No. 2 Six thousand, one hundred sixty dollars and zero cents **\$ 6,160.00**
ITEM 37 "WORDS"

PROJECT TOTAL: Two million, eight thousand, four hundred thirty nine dollars and zero cents **\$ 2,008,439.00**
ITEMS 1 – 37 "WORDS"

**La Sierra Avenue Resurfacing Project
El Sobrante Road to County of Riverside/City of Riverside Boundary
Community of Lake Hills
Project No. C6-0074**

IN WITNESS WHEREOF the parties hereto have executed this Contract as of the date set forth below.

COUNTY OF RIVERSIDE

ALL AMERICAN ASPHALT

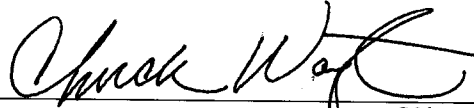
BY: 
CHUCK WASHINGTON
Chairman, Board of Supervisors

BY: 
Edward J. Carlson

DATED: OCT 30 2018

TITLE: Vice President
(If Corporation, affix Seal)

ATTEST:

ATTEST:

Kecia Harper-Ihem, Clerk of the Board

Michael Parkos

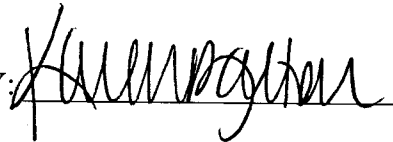
BY: 
Deputy

TITLE: Secretary

Licensed in accordance with an act providing for the registration of Contractors,

License No.: 267073

FORM APPROVED COUNTY COUNSEL

BY  10/12/18
KRISTINE BELL-VALDEZ DATE

Federal Employer Identification Number:

96-2595043

Department of Industrial Relations Registration Number:

1000001051

BY _____
"County"

All American Asphalt
"Corporation"
(Seal)



ALL AMERICAN ASPHALT
ALL AMERICAN AGGREGATES

T 951-736-7600 F 951-739-4671
P.O. BOX 2229, CORONA, CA 92878-2229
CONTRACTORS LICENSE #267073 AC12
DIR #1000001051

CORPORATE RESOLUTION

Resolved, that this Corporation, All American Asphalt, on January 8, 2018 authorizes Mark Luer to execute contracts and agreements on behalf of the Company in the capacity of President.



Michael Farkas
Secretary

Performance Bond

Recitals:

1. **All American Asphalt** (Contractor) has entered into a Contract with COUNTY OF RIVERSIDE (County) for construction of public work known as La Sierra Avenue Resurfacing Project, El Sobrante Road to County of Riverside/ City of Riverside Boundary, Community of Lake Hills, Project No. C6-0074.
2. _____, a _____ corporation (Surety), is the Surety under this Bond.

Agreement:

We, Contractor as Principal and Surety as Surety, jointly and severally agree, state, and are bound unto County, as obligee, as follows:

1. The amount of the obligation of this Bond is 100% of the estimated contract price for the Project of \$2,008,439.00 (Two million, eight thousand, four hundred thirty nine dollars and zero cents) and inures to the benefit of County.
2. This Bond is exonerated by Contractor doing all things to be kept and performed by it in strict conformance with the Contract Documents for this project, otherwise it remains in full force and effect for the recovery of loss, damage and expense of County resulting from failure of Contractor to so act. All of said Contract Documents are incorporated herein.
3. This obligation is binding on our successors and assigns.
4. For value received, Surety stipulates and agrees that no change, time extension, prepayment to Contractor, alteration or addition to the terms and requirements of the Contract Documents or the work to be performed thereunder shall affect its obligations hereunder and waives notice as to such matters, except the total contract price cannot be increased by more than 10% without approval of Surety.

THIS BOND is executed as of _____.

By _____ By _____

By _____ Type Name _____

Its Attorney in Fact
"Surety"

Title _____

"Contractor"

(Corporate Seal)

(Corporate Seal)

NOTE: This Bond must be executed by both parties with corporate seal affixed. All signatures must be acknowledged. (Attach acknowledgements).

Payment Bond

(Public Works - Civil Code §9550 et seq.)

The makers of this Bond are All American Asphalt, as Principal and Original Contractor and _____, a corporation, authorized to issue Surety Bonds in California, as Surety, and this Bond is issued in conjunction with that certain public works contract to be executed between Principal and COUNTY OF RIVERSIDE a public entity, as Owner, for \$2,008,439.00 (Two million, eight thousand, four hundred thirty nine dollars and zero cents), the total amount payable. The amount of this bond is one hundred percent (100%) of said sum. Said contract is for public work generally consisting of La Sierra Avenue Resurfacing Project, El Sobrante Road to County of Riverside/ City of Riverside Boundary, Community of Lake Hills, Project No. C6-0074.

The beneficiaries of this Bond are as is stated in 9554 of the Civil Code and requirements and conditions of this Bond are as is set forth in 9554, 9558, 9560 and 9564 of said code. Without notice, Surety consents to extension of time for performance, change in requirements, amount of compensation, or prepayment under said contract.

Dated: _____

Original Contractor – Principal

Surety

By _____

By _____

Its Attorney In Fact

Title _____

(If corporation, affix seal)

(Corporate Seal)

(Corporate Seal)

STATE
OF _____
COUNTY
OF _____

} ss. SURETY'S ACKNOWLEDGEMENT

On _____ before me, _____ personally appeared, _____, known to me, or proved to me on the basis of satisfactory evidence, to be the person whose name is subscribed to the within instrument and acknowledged to me that he executed the same in his authorized capacities, and that by his signature on the instrument the person, or the entity upon behalf of which the person acted, executed the instrument.

WITNESS my hand and official seal.

Signature of Notary Public

Notary Public (Seal)

NOTE: This Bond must be executed by both parties with corporate seal affixed. All signatures must be acknowledged. (Attach acknowledgements).

Performance Bond

Recitals:

- 1. **All American Asphalt** (Contractor) has entered into a Contract with COUNTY OF RIVERSIDE (County) for construction of public work known as **La Sierra Avenue Resurfacing Project, El Sobrante Road to County of Riverside/ City of Riverside Boundary, Community of Lake Hills, Project No. C6-0074.**
- 2. Fidelity and Deposit Company of Maryland, a Maryland corporation (Surety), is the Surety under this Bond.

Agreement:

We, Contractor as Principal and Surety as Surety, jointly and severally agree, state, and are bound unto County, as obligee, as follows:

- 1. The amount of the obligation of this Bond is 100% of the estimated contract price for the Project of **\$2,008,439.00 (Two million, eight thousand, four hundred thirty nine dollars and zero cents)** and inures to the benefit of County.
- 2. This Bond is exonerated by Contractor doing all things to be kept and performed by it in strict conformance with the Contract Documents for this project, otherwise it remains in full force and effect for the recovery of loss, damage and expense of County resulting from failure of Contractor to so act. All of said Contract Documents are incorporated herein.
- 3. This obligation is binding on our successors and assigns.
- 4. For value received, Surety stipulates and agrees that no change, time extension, prepayment to Contractor, alteration or addition to the terms and requirements of the Contract Documents or the work to be performed thereunder shall affect its obligations hereunder and waives notice as to such matters, except the total contract price cannot be increased by more than 10% without approval of Surety.

THIS BOND is executed as of September 19, 2018

By All American Asphalt By Fidelity and Deposit Company of Maryland

By *[Signature]* By *[Signature]*

By Edward J. Carlson Type Name Rebecca Haas-Bates

Title Vice President Its Attorney in Fact "Surety"

"Contractor"

(Corporate Seal) (Corporate Seal)

NOTE: This Bond must be executed by both parties with corporate seal affixed. All signatures must be acknowledged. (Attach acknowledgements).

CALIFORNIA ALL-PURPOSE ACKNOWLEDGEMENT

CIVIL CODE § 1189

A notary public or other officer completing this certificate verifies only the identity of the individual who signed the document to which this certificate is attached, and not the truthfulness, accuracy, or validity of that document.

State of California

County of Riverside

On September 21, 2018 before me, Courtney Chapas, Notary Public,
Date Here Insert name and Title of the Officer

personally appeared Edward J. Carlson
Name(s) of Signer(s)

who proved to me on the basis of satisfactory evidence to be the person(s) whose name(s) is/are subscribed to the within instrument and acknowledged to me that he/she/they executed the same in his/her/their authorized capacity(ies), and that by his/her/their signature(s) on the instrument the person(s), or the entity upon behalf of which the person(s) acted, executed the instrument.

I certify under PENALTY OF PERJURY under the laws of the State of California that the forgoing paragraph is true and correct.

WITNESS my hand and official seal.

Signature *Courtney Chapas*
Signature of Notary Public

Place Notary Seal Above

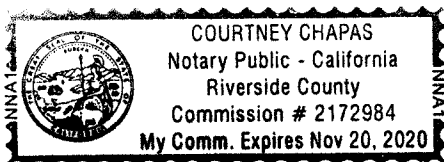

OPTIONAL

Though the information below is not required by law, it may prove valuable to person relying on the document and could prevent fraudulent removal and reattachment of this form to another document.

Description of Attached Document

Title or Type of Document Performance Bond

Document Date: September 19, 2018 Number of Pages: 1

Signer(s) Other Than Named Above: None

Capacity(ies) Claimed by Signer(s)

Signer's Name: Edward J. Carlson

- Individual
- Corporate Officer — Title(s): Vice President
- Partner Limited General
- Attorney in Fact
- Trustee
- Other: _____

RIGHT THUMBPRINT OF SIGNER
Top of thumb here

Signer is Representing: All American Asphalt

Signer's Name: _____

- Individual
- Corporate Officer — Title(s): _____
- Partner Limited General
- Attorney in Fact
- Trustee
- Other: _____

RIGHT THUMBPRINT OF SIGNER
Top of thumb here

Signer is Representing: All American Asphalt

CALIFORNIA ALL-PURPOSE ACKNOWLEDGMENT

CIVIL CODE § 1189

A notary public or other officer completing this certificate verifies only the identity of the individual who signed the document to which this certificate is attached, and not the truthfulness, accuracy, or validity of that document.

State of California)
County of Orange)

On 09/19/2018 before me, A. MacFarlane, Notary Public,
Date Here Insert Name and Title of the Officer

personally appeared Rebecca Haas-Bates
Name(s) of Signer(s)

who proved to me on the basis of satisfactory evidence to be the person(s) whose name(s) is/are subscribed to the within instrument and acknowledged to me that he/she/they executed the same in his/her/their authorized capacity(ies), and that by his/her/their signature(s) on the instrument the person(s), or the entity upon behalf of which the person(s) acted, executed the instrument.

I certify under PENALTY OF PERJURY under the laws of the State of California that the foregoing paragraph is true and correct.

WITNESS my hand and official seal.

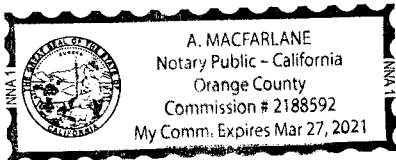

Signature [Handwritten Signature]
Signature of Notary Public

Place Notary Seal Above

OPTIONAL

Though this section is optional, completing this information can deter alteration of the document or fraudulent reattachment of this form to an unintended document.

Description of Attached Document

Title or Type of Document: Performance Bond No. 7658146 Document Date: 09/19/2018
Number of Pages: One (1) Signer(s) Other Than Named Above: All American Asphalt

Capacity(ies) Claimed by Signer(s)

Signer's Name: Rebecca Haas-Bates
 Corporate Officer — Title(s): _____
 Partner — Limited General
 Individual Attorney in Fact
 Trustee Guardian or Conservator
 Other: _____
Signer Is Representing: _____
Fidelity and Deposit Company of Maryland

Signer's Name: _____
 Corporate Officer — Title(s): _____
 Partner — Limited General
 Individual Attorney in Fact
 Trustee Guardian or Conservator
 Other: _____
Signer Is Representing: _____

EXTRACT FROM BY-LAWS OF THE COMPANIES

"Article V, Section 8, Attorneys-in-Fact. The Chief Executive Officer, the President, or any Executive Vice President or Vice President may, by written instrument under the attested corporate seal, appoint attorneys-in-fact with authority to execute bonds, policies, recognizances, stipulations, undertakings, or other like instruments on behalf of the Company, and may authorize any officer or any such attorney-in-fact to affix the corporate seal thereto; and may with or without cause modify or revoke any such appointment or authority at any time."

CERTIFICATE

I, the undersigned, Vice President of the ZURICH AMERICAN INSURANCE COMPANY, the COLONIAL AMERICAN CASUALTY AND SURETY COMPANY, and the FIDELITY AND DEPOSIT COMPANY OF MARYLAND, do hereby certify that the foregoing Power of Attorney is still in full force and effect on the date of this certificate; and I do further certify that Article V, Section 8, of the By-Laws of the Companies is still in force.

This Power of Attorney and Certificate may be signed by facsimile under and by authority of the following resolution of the Board of Directors of the ZURICH AMERICAN INSURANCE COMPANY at a meeting duly called and held on the 15th day of December 1998.

RESOLVED: "That the signature of the President or a Vice President and the attesting signature of a Secretary or an Assistant Secretary and the Seal of the Company may be affixed by facsimile on any Power of Attorney...Any such Power or any certificate thereof bearing such facsimile signature and seal shall be valid and binding on the Company."

This Power of Attorney and Certificate may be signed by facsimile under and by authority of the following resolution of the Board of Directors of the COLONIAL AMERICAN CASUALTY AND SURETY COMPANY at a meeting duly called and held on the 5th day of May, 1994, and the following resolution of the Board of Directors of the FIDELITY AND DEPOSIT COMPANY OF MARYLAND at a meeting duly called and held on the 10th day of May, 1990.

RESOLVED: "That the facsimile or mechanically reproduced seal of the company and facsimile or mechanically reproduced signature of any Vice-President, Secretary, or Assistant Secretary of the Company, whether made heretofore or hereafter, wherever appearing upon a certified copy of any power of attorney issued by the Company, shall be valid and binding upon the Company with the same force and effect as though manually affixed.

IN TESTIMONY WHEREOF, I have hereunto subscribed my name and affixed the corporate seals of the said Companies, this 19th day of September, 2018.



Michael C. Fay

Michael C. Fay, Vice President

TO REPORT A CLAIM WITH REGARD TO A SURETY BOND, PLEASE SUBMIT A COMPLETE DESCRIPTION OF THE CLAIM INCLUDING THE PRINCIPAL ON THE BOND, THE BOND NUMBER, AND YOUR CONTACT INFORMATION TO:

Zurich Surety Claims
1299 Zurich Way
Schaumburg, IL 60196-1056
www.reportsfclaims@zurichna.com
800-626-4577

ZURICH AMERICAN INSURANCE COMPANY
COLONIAL AMERICAN CASUALTY AND SURETY COMPANY
FIDELITY AND DEPOSIT COMPANY OF MARYLAND
POWER OF ATTORNEY

KNOW ALL MEN BY THESE PRESENTS: That the ZURICH AMERICAN INSURANCE COMPANY, a corporation of the State of New York, the COLONIAL AMERICAN CASUALTY AND SURETY COMPANY, a corporation of the State of Maryland, and the FIDELITY AND DEPOSIT COMPANY OF MARYLAND a corporation of the State of Maryland (herein collectively called the "Companies"), by Michael P. Bond, Vice President, in pursuance of authority granted by Article V, Section 8, of the By-Laws of said Companies, which are set forth on the reverse side hereof and are hereby certified to be in full force and effect on the date hereof, do hereby nominate, constitute, and appoint Rebecca Haas-Bates, its true and lawful agent and Attorney-in-Fact, to make, execute, seal and deliver, for, and on its behalf as surety, and as its act and deed: any and all bonds and undertakings, and the execution of such bonds or undertakings in pursuance of these presents, shall be as binding upon said Companies, as fully and amply, to all intents and purposes, as if they had been duly executed and acknowledged by the regularly elected officers of the ZURICH AMERICAN INSURANCE COMPANY at its office in New York, New York., the regularly elected officers of the COLONIAL AMERICAN CASUALTY AND SURETY COMPANY at its office in Owings Mills, Maryland., and the regularly elected officers of the FIDELITY AND DEPOSIT COMPANY OF MARYLAND at its office in Owings Mills, Maryland., in their own proper persons.

The said Vice President does hereby certify that the extract set forth on the reverse side hereof is a true copy of Article V, Section 8, of the By-Laws of said Companies, and is now in force.

IN WITNESS WHEREOF, the said Vice-President has hereunto subscribed his/her names and affixed the Corporate Seals of the said ZURICH AMERICAN INSURANCE COMPANY, COLONIAL AMERICAN CASUALTY AND SURETY COMPANY, and FIDELITY AND DEPOSIT COMPANY OF MARYLAND, this 19th day of September, A.D. 2018.

ATTEST:
ZURICH AMERICAN INSURANCE COMPANY
COLONIAL AMERICAN CASUALTY AND SURETY COMPANY
FIDELITY AND DEPOSIT COMPANY OF MARYLAND

Handwritten signature of Michael P. Bond

By: Michael P. Bond
Vice President



Handwritten signature of Dawn E. Brown

By: Dawn E. Brown
Secretary

State of Maryland
County of Baltimore

On this 19th day of September, A.D. 2018, before the subscriber, a Notary Public of the State of Maryland, duly commissioned and qualified, Michael P. Bond, Vice President and Dawn E. Brown, Secretary of the Companies, to me personally known to be the individuals and officers described in and who executed the preceding instrument, and acknowledged the execution of same, and being by me duly sworn, deposed and saith, that he/she is the said officer of the Company aforesaid, and that the seals affixed to the preceding instrument are the Corporate Seals of said Companies, and that the said Corporate Seals and the signature as such officer were duly affixed and subscribed to the said instrument by the authority and direction of the said Corporations.

IN TESTIMONY WHEREOF, I have hereunto set my hand and affixed my Official Seal the day and year first above written.

Handwritten signature of Constance A. Dunn

Constance A. Dunn, Notary Public
My Commission Expires: July 9, 2019





- Company Profile
- Company Search
- Company Information
- Old Company Names
- Agent for Service
- Reference Information
- NAIC Group List
- Lines of Business
- Workers' Compensation Complaint and Request for Action/Appeals Contact Information
- Financial Statements PDF's
- Annual Statements
- Quarterly Statements
- Company Complaint
- Company Performance & Comparison Data
- Company Enforcement Action
- Composite Complaints Studies
- Additional Info
- Find A Company Representative In Your Area
- View Financial Disclaimer

COMPANY PROFILE

Company Information

FIDELITY AND DEPOSIT COMPANY OF MARYLAND
1299 ZURICH WAY
SCHAUMBURG, IL 60196
800-382-2150

Old Company Names **Effective Date**

Agent For Service

KARISSA LOWRY
 2710 GATEWAY OAKS DRIVE
 SUITE 150N
 SACRAMENTO CA 95833

Reference Information

NAIC #:	39306
California Company ID #:	2479-4
Date Authorized in California:	01/01/1982
License Status:	UNLIMITED-NORMAL
Company Type:	Property & Casualty
State of Domicile:	MARYLAND

back to top

NAIC Group List

NAIC Group #: 0212 ZURICH INS GRP

Lines Of Business

The company is authorized to transact business within these lines of insurance. For an explanation of any of these terms, please refer to the glossary.

- AIRCRAFT
- AUTOMOBILE
- BOILER AND MACHINERY
- BURGLARY
- CREDIT
- FIRE
- LIABILITY
- MARINE
- MISCELLANEOUS
- PLATE GLASS
- SPRINKLER
- SURETY
- TEAM AND VEHICLE
- WORKERS' COMPENSATION

back to top

Payment Bond
(Public Works - Civil Code §9550 et seq.)

The makers of this Bond are All American Asphalt, as Principal and Original Contractor and Fidelity and Deposit Company of Maryland, a corporation, authorized to issue Surety Bonds in California, as Surety, and this Bond is issued in conjunction with that certain public works contract to be executed between Principal and COUNTY OF RIVERSIDE a public entity, as Owner, for \$2,008,439.00 (Two million, eight thousand, four hundred thirty nine dollars and zero cents), the total amount payable. The amount of this bond is one hundred percent (100%) of said sum. Said contract is for public work generally consisting of La Sierra Avenue Resurfacing Project, El Sobrante Road to County of Riverside/ City of Riverside Boundary, Community of Lake Hills, Project No. C6-0074.

The beneficiaries of this Bond are as is stated in 9554 of the Civil Code and requirements and conditions of this Bond are as is set forth in 9554, 9558, 9560 and 9564 of said code. Without notice, Surety consents to extension of time for performance, change in requirements, amount of compensation, or prepayment under said contract.

Dated: September 19, 2018

All American Asphalt
Original Contractor – Principal

Fidelity and Deposit Company of Maryland
Surety

By 
Edward J. Carlson

By 
Rebecca Haas-Bates
Its Attorney In Fact

Title Vice President
(If corporation, affix seal)

(Corporate Seal)

(Corporate Seal)

STATE
OF **Please See Attached**
COUNTY
OF _____

} ss. SURETY'S ACKNOWLEDGEMENT

On _____ before me, _____ personally appeared, _____, known to me, or proved to me on the basis of satisfactory evidence, to be the person whose name is subscribed to the within instrument and acknowledged to me that he executed the same in his authorized capacities, and that by his signature on the instrument the person, or the entity upon behalf of which the person acted, executed the instrument.

WITNESS my hand and official seal.

Signature of Notary Public

Notary Public (Seal)

NOTE: This Bond must be executed by both parties with corporate seal affixed. All signatures must be acknowledged. (Attach acknowledgements).

CALIFORNIA ALL-PURPOSE ACKNOWLEDGEMENT

CIVIL CODE § 1189

A notary public or other officer completing this certificate verifies only the identity of the individual who signed the document to which this certificate is attached, and not the truthfulness, accuracy, or validity of that document.

State of California

County of Riverside

On September 21, 2018 before me, Courtney Chapas, Notary Public,
Date Here Insert name and Title of the Officer

personally appeared Edward J. Carlson
Name(s) of Signer(s)

who proved to me on the basis of satisfactory evidence to be the person(s) whose name(s) is/are subscribed to the within instrument and acknowledged to me that he/she/they executed the same in his/her/their authorized capacity(ies), and that by his/her/their signature(s) on the instrument the person(s), or the entity upon behalf of which the person(s) acted, executed the instrument.

I certify under PENALTY OF PERJURY under the laws of the State of California that the forgoing paragraph is true and correct.

WITNESS my hand and official seal.

Signature Courtney Chapas
Signature of Notary Public



Place Notary Seal Above

OPTIONAL

Though the information below is not required by law, it may prove valuable to person relying on the document and could prevent fraudulent removal and reattachment of this form to another document.

Description of Attached Document

Title or Type of Document Payment Bond

Document Date: September 19, 2018 Number of Pages: 1

Signer(s) Other Than Named Above: None

Capacity(ies) Claimed by Signer(s)

Signer's Name: Edward J. Carlson

- Individual
- Corporate Officer — Title(s): Vice President
- Partner Limited General
- Attorney in Fact
- Trustee
- Other: _____

RIGHT THUMBPRINT OF SIGNER
Top of thumb here

Signer is Representing:
All American Asphalt

Signer's Name: _____

- Individual
- Corporate Officer — Title(s): _____
- Partner Limited General
- Attorney in Fact
- Trustee
- Other: _____

RIGHT THUMBPRINT OF SIGNER
Top of thumb here

Signer is Representing:
All American Asphalt

CALIFORNIA ALL-PURPOSE ACKNOWLEDGMENT

CIVIL CODE § 1189

A notary public or other officer completing this certificate verifies only the identity of the individual who signed the document to which this certificate is attached, and not the truthfulness, accuracy, or validity of that document.

State of California)
County of Orange)

On 09/19/2018 before me, A. MacFarlane, Notary Public,
Date Here Insert Name and Title of the Officer

personally appeared Rebecca Haas-Bates
Name(s) of Signer(s)

who proved to me on the basis of satisfactory evidence to be the person(s) whose name(s) is/are subscribed to the within instrument and acknowledged to me that he/she/they executed the same in his/her/their authorized capacity(ies), and that by his/her/their signature(s) on the instrument the person(s), or the entity upon behalf of which the person(s) acted, executed the instrument.

I certify under PENALTY OF PERJURY under the laws of the State of California that the foregoing paragraph is true and correct.

WITNESS my hand and official seal.

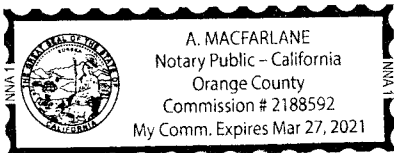

Signature [Handwritten Signature]
Signature of Notary Public

Place Notary Seal Above

OPTIONAL

Though this section is optional, completing this information can deter alteration of the document or fraudulent reattachment of this form to an unintended document.

Description of Attached Document

Title or Type of Document: Payment Bond No. 7658146 Document Date: 09/19/2018

Number of Pages: One (1) Signer(s) Other Than Named Above: All American Asphalt

Capacity(ies) Claimed by Signer(s)

Signer's Name: Rebecca Haas-Bates

- Corporate Officer — Title(s): _____
- Partner — Limited General
- Individual Attorney in Fact
- Trustee Guardian or Conservator
- Other: _____

Signer Is Representing: _____
Fidelity and Deposit Company of Maryland

Signer's Name: _____

- Corporate Officer — Title(s): _____
- Partner — Limited General
- Individual Attorney in Fact
- Trustee Guardian or Conservator
- Other: _____

Signer Is Representing: _____

EXTRACT FROM BY-LAWS OF THE COMPANIES

"Article V, Section 8, Attorneys-in-Fact. The Chief Executive Officer, the President, or any Executive Vice President or Vice President may, by written instrument under the attested corporate seal, appoint attorneys-in-fact with authority to execute bonds, policies, recognizances, stipulations, undertakings, or other like instruments on behalf of the Company, and may authorize any officer or any such attorney-in-fact to affix the corporate seal thereto; and may with or without cause modify or revoke any such appointment or authority at any time."

CERTIFICATE

I, the undersigned, Vice President of the ZURICH AMERICAN INSURANCE COMPANY, the COLONIAL AMERICAN CASUALTY AND SURETY COMPANY, and the FIDELITY AND DEPOSIT COMPANY OF MARYLAND, do hereby certify that the foregoing Power of Attorney is still in full force and effect on the date of this certificate; and I do further certify that Article V, Section 8, of the By-Laws of the Companies is still in force.

This Power of Attorney and Certificate may be signed by facsimile under and by authority of the following resolution of the Board of Directors of the ZURICH AMERICAN INSURANCE COMPANY at a meeting duly called and held on the 15th day of December 1998.

RESOLVED: "That the signature of the President or a Vice President and the attesting signature of a Secretary or an Assistant Secretary and the Seal of the Company may be affixed by facsimile on any Power of Attorney...Any such Power or any certificate thereof bearing such facsimile signature and seal shall be valid and binding on the Company."

This Power of Attorney and Certificate may be signed by facsimile under and by authority of the following resolution of the Board of Directors of the COLONIAL AMERICAN CASUALTY AND SURETY COMPANY at a meeting duly called and held on the 5th day of May, 1994, and the following resolution of the Board of Directors of the FIDELITY AND DEPOSIT COMPANY OF MARYLAND at a meeting duly called and held on the 10th day of May, 1990.

RESOLVED: "That the facsimile or mechanically reproduced seal of the company and facsimile or mechanically reproduced signature of any Vice-President, Secretary, or Assistant Secretary of the Company, whether made heretofore or hereafter, wherever appearing upon a certified copy of any power of attorney issued by the Company, shall be valid and binding upon the Company with the same force and effect as though manually affixed.

IN TESTIMONY WHEREOF, I have hereunto subscribed my name and affixed the corporate seals of the said Companies, this 19th day of September, 2018.



A handwritten signature in cursive script that reads "Michael C. Fay".

Michael C. Fay, Vice President

TO REPORT A CLAIM WITH REGARD TO A SURETY BOND, PLEASE SUBMIT A COMPLETE DESCRIPTION OF THE CLAIM INCLUDING THE PRINCIPAL ON THE BOND, THE BOND NUMBER, AND YOUR CONTACT INFORMATION TO:

Zurich Surety Claims
1299 Zurich Way
Schaumburg, IL 60196-1056
www.reportsfclaims@zurichna.com
800-626-4577

ZURICH AMERICAN INSURANCE COMPANY
COLONIAL AMERICAN CASUALTY AND SURETY COMPANY
FIDELITY AND DEPOSIT COMPANY OF MARYLAND
POWER OF ATTORNEY

KNOW ALL MEN BY THESE PRESENTS: That the ZURICH AMERICAN INSURANCE COMPANY, a corporation of the State of New York, the COLONIAL AMERICAN CASUALTY AND SURETY COMPANY, a corporation of the State of Maryland, and the FIDELITY AND DEPOSIT COMPANY OF MARYLAND a corporation of the State of Maryland (herein collectively called the "Companies"), by Michael P. Bond, Vice President, in pursuance of authority granted by Article V, Section 8, of the By-Laws of said Companies, which are set forth on the reverse side hereof and are hereby certified to be in full force and effect on the date hereof, do hereby nominate, constitute, and appoint Rebecca Haas-Bates, its true and lawful agent and Attorney-in-Fact, to make, execute, seal and deliver, for, and on its behalf as surety, and as its act and deed: any and all bonds and undertakings, and the execution of such bonds or undertakings in pursuance of these presents, shall be as binding upon said Companies, as fully and amply, to all intents and purposes, as if they had been duly executed and acknowledged by the regularly elected officers of the ZURICH AMERICAN INSURANCE COMPANY at its office in New York, New York., the regularly elected officers of the COLONIAL AMERICAN CASUALTY AND SURETY COMPANY at its office in Owings Mills, Maryland., and the regularly elected officers of the FIDELITY AND DEPOSIT COMPANY OF MARYLAND at its office in Owings Mills, Maryland., in their own proper persons.

The said Vice President does hereby certify that the extract set forth on the reverse side hereof is a true copy of Article V, Section 8, of the By-Laws of said Companies, and is now in force.

IN WITNESS WHEREOF, the said Vice-President has hereunto subscribed his/her names and affixed the Corporate Seals of the said ZURICH AMERICAN INSURANCE COMPANY, COLONIAL AMERICAN CASUALTY AND SURETY COMPANY, and FIDELITY AND DEPOSIT COMPANY OF MARYLAND, this 19th day of September, A.D. 2018.

ATTEST:
ZURICH AMERICAN INSURANCE COMPANY
COLONIAL AMERICAN CASUALTY AND SURETY COMPANY
FIDELITY AND DEPOSIT COMPANY OF MARYLAND

Handwritten signature of Michael P. Bond

By: Michael P. Bond
Vice President



Handwritten signature of Dawn E. Brown

By: Dawn E. Brown
Secretary

State of Maryland
County of Baltimore

On this 19th day of September, A.D. 2018, before the subscriber, a Notary Public of the State of Maryland, duly commissioned and qualified, Michael P. Bond, Vice President and Dawn E. Brown, Secretary of the Companies, to me personally known to be the individuals and officers described in and who executed the preceding instrument, and acknowledged the execution of same, and being by me duly sworn, deposed and saith, that he/she is the said officer of the Company aforesaid, and that the seals affixed to the preceding instrument are the Corporate Seals of said Companies, and that the said Corporate Seals and the signature as such officer were duly affixed and subscribed to the said instrument by the authority and direction of the said Corporations.

IN TESTIMONY WHEREOF, I have hereunto set my hand and affixed my Official Seal the day and year first above written.

Handwritten signature of Constance A. Dunn

Constance A. Dunn, Notary Public
My Commission Expires: July 9, 2019





- Company Profile
- Company Search
- Company Information
- Old Company Names
- Agent for Service
- Reference Information
- NAIC Group List
- Lines of Business
- Workers' Compensation
- Complaint and Request for Action/Appeals
- Contact Information
- Financial Statements PDF's
- Annual Statements
- Quarterly Statements
- Company Complaint
- Company Performance & Comparison Data
- Company Enforcement Action
- Composite Complaints Studies
- Additional Info
- Find A Company Representative In Your Area
- View Financial Disclaimer

COMPANY PROFILE

Company Information

FIDELITY AND DEPOSIT COMPANY OF MARYLAND
1299 ZURICH WAY
SCHAUMBURG, IL 60196
800-382-2150

Old Company Names	Effective Date
--------------------------	-----------------------

Agent For Service

KARISSA LOWRY
 2710 GATEWAY OAKS DRIVE
 SUITE 150N
 SACRAMENTO CA 95833

Reference Information

NAIC #:	39306
California Company ID #:	2479-4
Date Authorized in California:	01/01/1982
License Status:	UNLIMITED-NORMAL
Company Type:	Property & Casualty
State of Domicile:	MARYLAND

back to top

NAIC Group List

NAIC Group #: 0212 ZURICH INS GRP

Lines Of Business

The company is authorized to transact business within these lines of insurance. For an explanation of any of these terms, please refer to the glossary.

- AIRCRAFT
- AUTOMOBILE
- BOILER AND MACHINERY
- BURGLARY
- CREDIT
- FIRE
- LIABILITY
- MARINE
- MISCELLANEOUS
- PLATE GLASS
- SPRINKLER
- SURETY
- TEAM AND VEHICLE
- WORKERS' COMPENSATION

back to top



CERTIFICATE OF LIABILITY INSURANCE

DATE (MM/DD/YYYY)

9/25/2018

THIS CERTIFICATE IS ISSUED AS A MATTER OF INFORMATION ONLY AND CONFERS NO RIGHTS UPON THE CERTIFICATE HOLDER. THIS CERTIFICATE DOES NOT AFFIRMATIVELY OR NEGATIVELY AMEND, EXTEND OR ALTER THE COVERAGE AFFORDED BY THE POLICIES BELOW. THIS CERTIFICATE OF INSURANCE DOES NOT CONSTITUTE A CONTRACT BETWEEN THE ISSUING INSURER(S), AUTHORIZED REPRESENTATIVE OR PRODUCER, AND THE CERTIFICATE HOLDER.

IMPORTANT: If the certificate holder is an ADDITIONAL INSURED, the policy(ies) must have ADDITIONAL INSURED provisions or be endorsed. If SUBROGATION IS WAIVED, subject to the terms and conditions of the policy, certain policies may require an endorsement. A statement on this certificate does not confer rights to the certificate holder in lieu of such endorsement(s).

PRODUCER Edgewood Partners Insurance Center P.O. Box 5003 San Ramon, CA 94583 www.epicbrokers.com CA LICENSE #0B29370	CONTACT NAME: Certificates Department PHONE (A/C, No, Ext): 925-244-7700 FAX (A/C, No): 925-901-0671 E-MAIL ADDRESS: EPICcerts@epicbrokers.com													
	<table border="1"> <thead> <tr> <th>INSURER(S) AFFORDING COVERAGE</th> <th>NAIC #</th> </tr> </thead> <tbody> <tr> <td>INSURER A : Arch Specialty Insurance Company</td> <td>21199</td> </tr> <tr> <td>INSURER B : Zurich American Insurance Company</td> <td>16535</td> </tr> <tr> <td>INSURER C : American Guarantee and Liability Ins Co</td> <td>26247</td> </tr> <tr> <td>INSURER D :</td> <td></td> </tr> <tr> <td>INSURER E :</td> <td></td> </tr> <tr> <td>INSURER F :</td> <td></td> </tr> </tbody> </table>	INSURER(S) AFFORDING COVERAGE	NAIC #	INSURER A : Arch Specialty Insurance Company	21199	INSURER B : Zurich American Insurance Company	16535	INSURER C : American Guarantee and Liability Ins Co	26247	INSURER D :		INSURER E :		INSURER F :
INSURER(S) AFFORDING COVERAGE	NAIC #													
INSURER A : Arch Specialty Insurance Company	21199													
INSURER B : Zurich American Insurance Company	16535													
INSURER C : American Guarantee and Liability Ins Co	26247													
INSURER D :														
INSURER E :														
INSURER F :														
INSURED All American Asphalt P.O. Box 2229 Corona CA 92878														

COVERAGES **CERTIFICATE NUMBER:** 44434199 **REVISION NUMBER:**

THIS IS TO CERTIFY THAT THE POLICIES OF INSURANCE LISTED BELOW HAVE BEEN ISSUED TO THE INSURED NAMED ABOVE FOR THE POLICY PERIOD INDICATED. NOTWITHSTANDING ANY REQUIREMENT, TERM OR CONDITION OF ANY CONTRACT OR OTHER DOCUMENT WITH RESPECT TO WHICH THIS CERTIFICATE MAY BE ISSUED OR MAY PERTAIN, THE INSURANCE AFFORDED BY THE POLICIES DESCRIBED HEREIN IS SUBJECT TO ALL THE TERMS, EXCLUSIONS AND CONDITIONS OF SUCH POLICIES. LIMITS SHOWN MAY HAVE BEEN REDUCED BY PAID CLAIMS.

INSR LTR	TYPE OF INSURANCE	ADDL INSD	SUBR WVD	POLICY NUMBER	POLICY EFF (MM/DD/YYYY)	POLICY EXP (MM/DD/YYYY)	LIMITS
A	<input checked="" type="checkbox"/> COMMERCIAL GENERAL LIABILITY <input type="checkbox"/> CLAIMS-MADE <input checked="" type="checkbox"/> OCCUR GEN'L AGGREGATE LIMIT APPLIES PER: <input type="checkbox"/> POLICY <input checked="" type="checkbox"/> PROJECT <input type="checkbox"/> LOC OTHER:			DPC1005856-02	8/1/2018	8/1/2019	EACH OCCURRENCE \$ 1,000,000 DAMAGE TO RENTED PREMISES (Ea occurrence) \$ 100,000 MED EXP (Any one person) \$ PERSONAL & ADV INJURY \$ 1,000,000 GENERAL AGGREGATE \$ 2,000,000 PRODUCTS - COMP/OP AGG \$ 2,000,000 \$
B	AUTOMOBILE LIABILITY <input checked="" type="checkbox"/> ANY AUTO <input type="checkbox"/> OWNED AUTOS ONLY <input type="checkbox"/> SCHEDULED AUTOS <input checked="" type="checkbox"/> HIRED AUTOS ONLY <input checked="" type="checkbox"/> NON-OWNED AUTOS ONLY			BAP5571088-06	8/1/2018	8/1/2019	COMBINED SINGLE LIMIT (Ea accident) \$ 2,000,000 BODILY INJURY (Per person) \$ BODILY INJURY (Per accident) \$ PROPERTY DAMAGE (Per accident) \$ \$
C	<input type="checkbox"/> UMBRELLA LIAB <input checked="" type="checkbox"/> OCCUR <input checked="" type="checkbox"/> EXCESS LIAB <input type="checkbox"/> CLAIMS-MADE <input type="checkbox"/> DED <input checked="" type="checkbox"/> RETENTION \$ 10,000			SXS019797002	8/1/2018	8/1/2019	EACH OCCURRENCE \$ 5,000,000 AGGREGATE \$ 5,000,000 Following-Form \$
B	WORKERS COMPENSATION AND EMPLOYERS' LIABILITY ANY PROPRIETOR/PARTNER/EXECUTIVE OFFICER/MEMBER EXCLUDED? (Mandatory in NH) If yes, describe under DESCRIPTION OF OPERATIONS below	Y/N	N/A	WC593205705	8/1/2018	8/1/2019	<input checked="" type="checkbox"/> PER STATUTE <input type="checkbox"/> OTH-ER E.L. EACH ACCIDENT \$ 1,000,000 E.L. DISEASE - EA EMPLOYEE \$ 1,000,000 E.L. DISEASE - POLICY LIMIT \$ 1,000,000

DESCRIPTION OF OPERATIONS / LOCATIONS / VEHICLES (ACORD 101, Additional Remarks Schedule, may be attached if more space is required)

Project #C6-0074 / RE: La Sierra Avenue Resurfacing Project / El Sobrante Rd to County of Riverside/City of Riverside Boundary / Community Lake Hills

Certificate Holder is Additional Insured if Required by Written Contract Excluding Workers Compensation

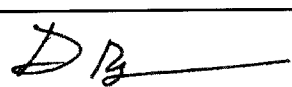
CERTIFICATE HOLDER County of Riverside Transportation Department ATTN: Contracts/Bidding Unit 3525 14th Street, 2nd Floor Riverside CA 92501	CANCELLATION SHOULD ANY OF THE ABOVE DESCRIBED POLICIES BE CANCELLED BEFORE THE EXPIRATION DATE THEREOF, NOTICE WILL BE DELIVERED IN ACCORDANCE WITH THE POLICY PROVISIONS.
	AUTHORIZED REPRESENTATIVE  Certificates Department

© 1988-2015 ACORD CORPORATION. All rights reserved.

ACORD 25 (2016/03)

The ACORD name and logo are registered marks of ACORD



PO Box 5003
San Ramon, CA 94583
Phone: 925.244.7700
Fax: 925.901-0244
Email: EPICcerts@epicbrokers.com

CERTIFICATE HOLDER:

County of Riverside
Transportation Department
ATTN: Contracts/Bidding Unit
3525 14th Street, 2nd Floor
Riverside CA 92501

To: Whom it may concern
Regarding: Notice of Cancellation
Date Issued: 9/25/2018
Named Insured(s): All American Asphalt
Policy Number(s): DPC1005856-02
BAP5571088-06
WC593205705
SXS019797002

Should the above described policy be cancelled before the expiration date thereof, we will mail 30 days written notice to the above referenced Certificate Holder; except, 10 days notice for non-payment of premium.

Sincerely,

Dan Ryan, Managing Principal

THIS ENDORSEMENT CHANGES THE POLICY. PLEASE READ IT CAREFULLY.

BLANKET ADDITIONAL INSURED ENDORSEMENT

This endorsement modifies insurance provided under the following:

COMMERCIAL GENERAL LIABILITY COVERAGE FORM
COMMERCIAL GENERAL LIABILITY SELF-INSURED RETENTION COVERAGE FORM

SECTION II – WHO IS AN INSURED is amended to include as an additional insured those persons or organizations who are required under a written contract with you to be named as an additional insured, but only with respect to liability for "bodily injury", "property damage", or "personal and advertising injury" caused, in whole or in part, by your acts or omissions or the acts or omissions of your subcontractors:

- A. In the performance of your ongoing operations or "your work", including "your work" that has been completed; or
- B. In connection with your premises owned by or rented to you.

As used in this endorsement, the words "you" and "your" refer to the Named Insured.
All other terms and conditions of this Policy remain unchanged.

REFERENCE:

Project #C6-0074 / RE: La Sierra Avenue Resurfacing Project / El Sobrante Rd to County of Riverside/City of Riverside Boundary / Community Lake Hills

SCHEDULE:

The County of Riverside, its directors, officers, elected and appointed officials, employees, agents, and representatives; City of Riverside, its elected and appointed officials, employees, agents, and representatives; Western Municipal Water District (WMWD), its elected and appointed officials, employees, agents, and representatives

Endorsement Number:

This endorsement is effective on the inception date of this policy unless otherwise stated herein.
(The information below is required only when this endorsement is issued subsequent to preparation of the policy.)

Policy Number: DPC1005856-02

Named Insured: All American Asphalt

Endorsement Effective Date: 08/01/2018



00 CGL0006 00 05 07

Page 1 of 1

THIS ENDORSEMENT CHANGES THE POLICY. PLEASE READ IT CAREFULLY.

OTHER INSURANCE - BROAD FORM, CGL POLICY ENDORSEMENT

This endorsement modifies insurance provided under the following:

COMMERCIAL GENERAL LIABILITY COVERAGE FORM
COMMERCIAL GENERAL LIABILITY SELF-INSURED RETENTION COVERAGE FORM

Under **SECTION IV – COMMERCIAL GENERAL LIABILITY CONDITIONS**, the following paragraph is added to Condition 4. **Other Insurance**:

Where the Named Insured is required by a written contract to provide insurance that is primary and non-contributory, and the written contract so requiring is executed by the Named Insured before any "occurrence" or offense, this insurance will be primary, but only if and to the extent required by that written contract.

All other terms and conditions of this Policy remain unchanged.

REFERENCE:

Project #C6-0074 / RE: La Sierra Avenue Resurfacing Project / El Sobrante Rd to County of Riverside/City of Riverside Boundary / Community Lake Hills

SCHEDULE:

The County of Riverside, its directors, officers, elected and appointed officials, employees, agents, and representatives; City of Riverside, its elected and appointed officials, employees, agents, and representatives; Western Municipal Water District (WMWD), its elected and appointed officials, employees, agents, and representatives

Endorsement Number:

This endorsement is effective on the inception date of this policy unless otherwise stated herein.
(The information below is required only when this endorsement is issued subsequent to preparation of the policy.)

Policy Number: DPC1005856-02

Named Insured: All American Asphalt

Endorsement Effective Date: 08/01/2018

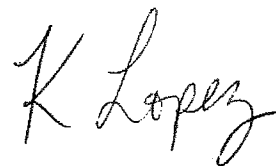

00 CGL0130 00 09 06

Page 1 of 1

THIS ENDORSEMENT CHANGES THE POLICY. PLEASE READ IT CAREFULLY.

WAIVER OF SUBROGATION ENDORSEMENT

This endorsement modifies insurance provided under the following:

COMMERCIAL GENERAL LIABILITY COVERAGE FORM
COMMERCIAL GENERAL LIABILITY SELF-INSURED RETENTION COVERAGE FORM

SCHEDULE

Name of Person or Organization: Where required by written contract.

Under **SECTION IV – COMMERCIAL GENERAL LIABILITY CONDITIONS, Condition 8. Transfer Of Rights Of Recovery Against Others To Us** is amended by the addition of the following provision:

We waive any right of recovery we may have against the person or organization shown in the **SCHEDULE** above because of payments we make for injury or damage arising out of your operations or "your work" done under a written contract with that person or organization.

All other terms and conditions of this Policy remain unchanged.

REFERENCE:

Project #C6-0074 / RE: La Sierra Avenue Resurfacing Project / El Sobrante Rd to County of Riverside/City of Riverside Boundary / Community Lake Hills

SCHEDULE:

The County of Riverside, its directors, officers, elected and appointed officials, employees, agents, and representatives; City of Riverside, its elected and appointed officials, employees, agents, and representatives; Western Municipal Water District (WMWD), its elected and appointed officials, employees, agents, and representatives

Endorsement Number:

This endorsement is effective on the inception date of this policy unless otherwise stated herein. (The information below is required only when this endorsement is issued subsequent to preparation of the policy.)

Policy Number: DPC1005856-02

Named Insured: All American Asphalt

Endorsement Effective Date: 08/01/2018



00 CGL0121 00 09 06 Includes copyrighted material of Insurance Services Office, Inc. Page 1 of 1

THIS ENDORSEMENT CHANGES THE POLICY. PLEASE READ IT CAREFULLY.

DESIGNATED INSURED

This endorsement modifies insurance provided under the following:

- BUSINESS AUTO COVERAGE FORM
- GARAGE COVERAGE FORM
- MOTOR CARRIER COVERAGE FORM
- TRUCKERS COVERAGE FORM

With respect to coverage provided by this endorsement, the provisions of the Coverage Form apply unless modified by this endorsement.

This endorsement identifies person(s) or organization(s) who are "insureds" under the Who Is An Insured Provision of the Coverage Form. This endorsement does not alter coverage provided in the Coverage Form.

This endorsement changes the policy effective on the inception date of the policy unless another date is indicated below.

Endorsement Effective: 08/01/2018
Named Insured: All American Asphalt

SCHEDULE

Name of Person(s) or Organization(s): ANY PERSON OR ORGANIZATION TO WHOM OR WHICH YOU ARE REQUIRED TO PROVIDE ADDITIONAL INSURED STATUS OR ADDITIONAL INSURED STATUS ON A PRIMARY, NON-CONTRIBUTORY BASIS, IN A WRITTEN CONTRACT OR WRITTEN AGREEMENT EXECUTED PRIOR TO LOSS, EXCEPT WHERE SUCH CONTRACT OR AGREEMENT IS PROHIBITED BY LAW.
--

REFERENCE:

Project #C6-0074 / RE: La Sierra Avenue Resurfacing Project / El Sobrante Rd to County of Riverside/City of Riverside Boundary / Community Lake Hills

SCHEDULE:

The County of Riverside, its directors, officers, elected and appointed officials, employees, agents, and representatives; City of Riverside, its elected and appointed officials, employees, agents, and representatives; Western Municipal Water District (WMWD), its elected and appointed officials, employees, agents, and representatives

(If no entry appears above, information required to complete this endorsement will be shown in the Declarations as applicable to the endorsement.)

Each person or organization shown in the Schedule is an "insured" for Liability Coverage, but only to the extent that person or organization qualifies as an "insured" under the Who Is An Insured Provision contained in **Section II** of the Coverage Form.

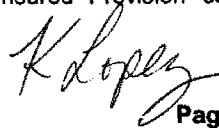

THIS ENDORSEMENT CHANGES THE POLICY. PLEASE READ IT CAREFULLY.

**WAIVER OF TRANSFER OF RIGHTS OF RECOVERY
AGAINST OTHERS TO US (WAIVER OF SUBROGATION)**

This endorsement modifies insurance provided under the following:

- BUSINESS AUTO COVERAGE FORM
- BUSINESS AUTO PHYSICAL DAMAGE COVERAGE FORM
- GARAGE COVERAGE FORM
- MOTOR CARRIER COVERAGE FORM
- TRUCKERS COVERAGE FORM

With respect to coverage provided by this endorsement, the provisions of the Coverage Form apply unless modified by the endorsement.

This endorsement changes the policy effective on the inception date of the policy unless another date is indicated below.

<p>Named Insured: All American Asphalt</p> <p>Endorsement Effective Date: 08/01/2018</p>
--

SCHEDULE

<p>Name(s) Of Person(s) Or Organization(s): ALL PERSONS AND/OR ORGANIZATIONS THAT ARE REQUIRED BY WRITTEN CONTRACT OR AGREEMENT WITH THE INSURED, EXECUTED PRIOR TO THE ACCIDENT OR LOSS, THAT WAIVER OF SUBROGATION BE PROVIDED UNDER THIS POLICY</p>

REFERENCE:
 Project #C6-0074 / RE: La Sierra Avenue Resurfacing Project / El Sobrante Rd to County of Riverside/City of Riverside Boundary / Community Lake Hills

SCHEDULE:
 The County of Riverside, its directors, officers, elected and appointed officials, employees, agents, and representatives; City of Riverside, its elected and appointed officials, employees, agents, and representatives; Western Municipal Water District (WMWD), its elected and appointed officials, employees, agents, and representatives

Information required to complete this Schedule, if not shown above, will be shown in the Declarations.

The **Transfer Of Rights Of Recovery Against Others To Us** Condition does not apply to the person(s) or organization(s) shown in the Schedule, but only to the extent that subrogation is waived prior to the "accident" or the "loss" under a contract with that person or organization.



WAIVER OF OUR RIGHT TO RECOVER FROM OTHERS ENDORSEMENT— CALIFORNIA

We have the right to recover our payments from anyone liable for an injury covered by this policy. We will not enforce our right against the person or organization named in the Schedule. (This agreement applies only to the extent that you perform work under a written contract that requires you to obtain this agreement from us.)

You must maintain payroll records accurately segregating the remuneration of your employees while engaged in the work described in the Schedule.

The additional premium for this endorsement shall be 0.00 % of the California workers' compensation premium otherwise due on such remuneration.

Schedule

Person or Organization

Job Description

ALL PERSONS AND/OR ORGANIZATIONS THAT ARE REQUIRED BY WRITTEN CONTRACT OR AGREEMENT WITH THE INSURED, EXECUTED PRIOR TO THE LOSS, THAT WAIVER OF SUBROGATION BE PROVIDED UNDER THIS POLICY FOR WORK PERFORMED BY YOU FOR THAT PERSON AND/OR ORGANIZATION

ALL CALIFORNIA OPERATIONS

SCHEDULE:

The County of Riverside, its directors, officers, elected and appointed officials, employees, agents, and representatives; City of Riverside, its elected and appointed officials, employees, agents, and representatives; Western Municipal Water District (WMWD), its elected and appointed officials, employees, agents, and representatives

REFERENCE:

Project #C6-0074 / RE: La Sierra Avenue Resurfacing Project / El Sobrante Rd to County of Riverside/City of Riverside Boundary / Community Lake Hills

Policy Number: WC593205705

Named Insured: All American Asphalt

Endorsement Effective Date: 08/01/2018





Straight Excess Liability Policy

Declarations

- AMERICAN GUARANTEE AND LIABILITY INSURANCE COMPANY
- AMERICAN ZURICH INSURANCE COMPANY
- ZURICH AMERICAN INSURANCE COMPANY OF ILLINOIS

Policy Number: SXS 0197970-02

Renewal of Number: SXS 0197970-01

- 1. Named Insured: ALL AMERICAN ASPHALT Producer: WHOLESALE TRADING INSURANCE SERVICES, LLC
- 2. Mailing Address: P.O. BOX 2229 135 MAIN ST STE 1875
CORONA, CA 92878 SAN FRANCISCO, CA 94105-1850
- 3. Policy Period: FROM: 08/01/2018 TO: 08/01/2019
at 12:01 A.M. Standard Time at the address of the Named Insured.

4. Limits Of Insurance:

A.	\$ 5,000,000	Occurrence
B.	\$ 5,000,000	Other Aggregate
C.	\$ 5,000,000	Products/Completed Operations Aggregate

5. Policy Premium:
Advance Premium _____
Policy Minimum Earned Premium _____

- 6. Underlying Insurance: See Attached Schedule Of Underlying Insurance
- 7. Endorsements Attached: See Attached Schedule Of Forms And Endorsements



ZURICH[®]

Schedule of Underlying Insurance

Policy No.	Eff. Date of Pol.	Exp. Date of Pol.	Eff. Date of End.	Producer	Add'l Prem.	Return Prem.
SXS 0197970-02	08/01/2018	08/01/2019	08/01/2018	69224000	-----	-----

Named Insured and Mailing Address:

ALL AMERICAN ASPHALT
P.O. BOX 2229
CORONA, CA 92878

Producer:

WHOLESALE TRADING INSURANCE SERVICES,
LLC
135 MAIN ST STE 1875
SAN FRANCISCO, CA 94105-1850

Company, Policy No. and Term	Coverage	Applicable Limits
A. Company: Arch Specialty Insurance Company	Commercial General Liability	\$1,000,000 Premises - Each Occurrence
Policy No: DPC1005856-02	Main GL	\$1,000,000 Products / Completed Ops - Each Occurrence
Term: 08/01/2018 to 08/01/2019		\$2,000,000 Products / Completed Operations Aggregate
		\$2,000,000 General Aggregate
		Per Project
		Term Aggregate
		Unlimited
		\$1,000,000 Personal Injury/ Advertising Injury
	Including Employee Benefits	\$1,000,000 Employee Benefits - Each Claim
		\$2,000,000 Employee Benefits - General Aggregate

Company, Policy No. and Term	Coverage	Applicable Limits
B. Company: Zurich American Insurance Company	Commercial Auto Liability	\$2,000,000 Combined Single Limit
Policy No: BAP 5571088-06		
Term: 08/01/2018 to 08/01/2019		

Company, Policy No. and Term	Coverage	Applicable Limits
------------------------------	----------	-------------------

C. Company: Zurich American Insurance Company

Employers Liability

\$1,000,000 Bodily Injury By Accident - Each Accident

Policy No: WC 5932057-05

\$1,000,000 Bodily Injury By Disease - Each Employee

Term: 08/01/2018 to 08/01/2019

\$1,000,000 Bodily Injury By Disease - Policy Limit



ZURICH[®]

Extended Schedule of Underlying Insurance

Policy No.	Eff. Date of Pol.	Exp. Date of Pol.	Eff. Date of End.	Producer	Add'l Prem.	Return Prem.
SXS 0197970-02	08/01/2018	08/01/2019	08/01/2018	69224000	-----	-----

Named Insured and Mailing Address:

ALL AMERICAN ASPHALT
P.O. BOX 2229
CORONA, CA 92878

Producer:

WHOLESALE TRADING INSURANCE SERVICES,
LLC
135 MAIN ST STE 1875
SAN FRANCISCO, CA 94105-1850

Company, Policy No. and Term	Coverage	Applicable Limits	
Company: Arch Specialty Ins Co	Commercial General Liability	\$2,000,000	Premises - Each Occurrence
Policy No: DPC1005857-02	CalTrans GL	\$2,000,000	Products / Completed Ops - Each Occurrence
Term: 08/01/2018 to 08/01/2019		\$4,000,000	Products / Completed Operations Aggregate
		\$4,000,000	General Aggregate
		\$2,000,000	Personal Injury/ Advertising Injury



ZURICH®

Straight Excess Liability Policy

There are provisions in this policy that restrict coverage. Read the entire policy carefully to determine rights, duties and what is and is not covered.

Throughout this policy, the words "you" and "your" refer to the Named Insured shown in the Declarations, and any other person or organization qualifying as such in **underlying insurance**. The words "we", "us" and "our" refer to the company providing this insurance.

The word "insured(s)" means any person or organization qualifying as such in **underlying insurance** but only to the extent and within the scope for which such "insured(s)" qualify for coverage in **underlying insurance**.

Words and phrases that are printed in bold-face type are defined in this policy. These definitions are found in **SECTION VI. DEFINITIONS** of this policy or in the specific policy provision where they appear.

In consideration of the payment of the premium and in reliance upon the statements in the Declarations and in accordance with the provisions of this policy, we agree with you to provide coverage as follows:

Insuring Agreements

SECTION I. COVERAGE

- A. We will pay on behalf of the insured those damages covered by this insurance in excess of the total Applicable Limits of **underlying insurance**. This policy includes:
1. The terms and conditions of **underlying insurance** to the extent such terms and conditions are not inconsistent or do not conflict with the terms and conditions referred to in Paragraph 2. below; and
 2. The terms and conditions that apply to this policy.
- B. Notwithstanding anything to the contrary contained in Paragraph A. above, if **underlying insurance** does not apply to damages for reasons other than exhaustion of total applicable limits of insurance by payment of **loss**, then this policy does not apply to such damages.
- C. The amount we will pay under this policy is limited as described in **SECTION II. LIMITS OF INSURANCE**.
- D. We have no obligation under this policy with respect to any settlement made without our consent.
- E. The insurance afforded under this policy applies to bodily injury or property damage only if prior to the Policy Period, neither you nor any **authorized person** knew that the bodily injury or property damage had occurred, in whole or in part. If you or any **authorized person** knew, prior to the Policy Period, that the bodily injury or property damage occurred, then any continuation, change or resumption of such bodily injury or property damage during or after the Policy Period will be deemed to have been known prior to the Policy Period.

Bodily injury or property damage which occurs during the Policy Period and was not, prior to the Policy Period, known to have occurred by you or any **authorized person** includes any continuation, change or resumption of that bodily injury or property damage after the Policy Period; and

Bodily injury or property damage will be deemed to have been known to have occurred at the earliest time when you or any **authorized person**:

1. Reports all or any part of, the bodily injury or property damage to us or any other insurer;
2. Receives a written or verbal demand or claim for damages because of the bodily injury or property damage; or
3. Becomes aware by any other means that bodily injury or property damage has occurred or has begun to occur.

California
Department of Insurance

Insurance Protection for All Californians

List of Approved Surplus Line Insurers (LASLI)

Please use the "Find" option in the "Edit" menu of your browser to search for a particular company.

List is current as of: June 29, 2018

[A](#) | [B - D](#) | [E - G](#) | [H - L](#) | [M - P](#) | [Q - Z](#)

A

Insurer	Date Approved
Acceptance Casualty Insurance Company (Nebraska)	10/23/2007
Admiral Insurance Company (Delaware)	06/30/1995
Adriatic Insurance Company (North Dakota)	06/30/1995
AIQ Specialty Insurance Company (Illinois) (Name changed from Chartis Specialty Insurance Company effective 10/01/2013)	06/30/1995
AIX Specialty Insurance Company (Delaware)	06/05/2009
Allianz Global Corporate & Specialty SE (Germany) (Name Changed from Allianz Global Corporate Specialty AG effective 11/13/2013)	06/16/2004
Allied World National Assurance Company (New Hampshire) (Name changed from Newmarket Underwriters Insurance Company effective 10/03/2007)	12/18/1997
Allied World Surplus Lines Insurance Company (Arkansas) (Name changed from Darwin Select Insurance Company effective 06/03/2014) (Name changed from ULICO Indemnity Company Effective 05/13/2010)	12/22/1995
American Empire Surplus Lines Insurance Company (Delaware)	09/01/1995
American Western Home Insurance Company (Oklahoma)	09/01/1995
Arch Insurance Company (Europe) Limited (U.K.)	10/19/2009
Arch Specialty Insurance Company (Missouri) (Name changed from Rock River Insurance Company effective 08/01/2002) (Domicile changed from Nebraska to Missouri effective 09/30/2014)	09/01/1995
Aspen Insurance UK Limited (U.K.)	12/29/2004
Aspen Specialty Insurance Company (North Dakota) (Name changed from Dakota Specialty Insurance Company, effective 10/22/2003)	03/03/1998
Associated Industries Insurance Company, Inc. (Florida)	01/11/2012
Atain Specialty Insurance Company (Michigan) (Name changed from USF Insurance Company effective 08/25/2011) (Domicile changed from Pennsylvania to Michigan effective 12/31/2007)	09/01/1995
Atlantic Casualty Insurance Company (North Carolina)	07/16/2009
AXA Corporate Solutions Assurance (France)	08/14/2003
AXIS Specialty Europe SE (Ireland) (Name changed from AXIS Specialty Europe Public Limited Company effective 09/10/2012. Name changed from AXIS Specialty Europe Limited effective 04/26/2012)	06/20/2007
AXIS Surplus Insurance Company (Illinois) (Name changed from Sheffield Insurance Corporation effective 06/09/2003)	12/15/1995

[Back to Top](#)

B - D

Insurer	Date Approved
Berkley Assurance Company (Iowa)	07/20/2011
Berkley Specialty Insurance Company (Delaware) (Name changed from Berkley Regional Specialty Insurance Company effective 07/01/2018)	04/12/2012
Berkshire Hathaway International Insurance Limited (UK)	04/01/2008



- Company Profile
- Company Search
- Company Information
- Old Company Names
- Agent for Service
- Reference Information
- NAIC Group List
- Lines of Business
- Workers' Compensation
- Complaint and Request for Action/Appeals
- Contact Information
- Financial Statements PDF's
- Annual Statements
- Quarterly Statements
- Company Complaint
- Company Performance & Comparison Data
- Company Enforcement Action
- Composite Complaints Studies
- Additional Info
- Find A Company Representative In Your Area
- View Financial Disclaimer

COMPANY PROFILE

Company Information

ZURICH AMERICAN INSURANCE COMPANY

**1299 ZURICH WAY
SCHAUMBURG, IL 60196
800-936-5873**

Old Company Names

Effective Date

Agent For Service

KARISSA LOWRY
2710 GATEWAY OAKS DRIVE
SUITE 150N
SACRAMENTO CA 95833

Reference Information

NAIC #:	16535
California Company ID #:	4581-5
Date Authorized in California:	01/01/1999
License Status:	UNLIMITED-NORMAL
Company Type:	Property & Casualty
State of Domicile:	NEW YORK

back to top

NAIC Group List

NAIC Group #: 0212 ZURICH INS GRP

Lines Of Business

The company is authorized to transact business within these lines of insurance. For an explanation of any of these terms, please refer to the glossary.

- AIRCRAFT
- AUTOMOBILE
- BOILER AND MACHINERY
- BURGLARY
- COMMON CARRIER LIABILITY
- CREDIT
- DISABILITY
- FIRE
- LIABILITY
- MARINE
- MISCELLANEOUS
- PLATE GLASS
- SPRINKLER
- SURETY
- TEAM AND VEHICLE
- WORKERS' COMPENSATION

back to top



- [Company Profile](#)
- [Company Search](#)
- [Company Information](#)
- [Old Company Names](#)
- [Agent for Service](#)
- [Reference Information](#)
- [NAIC Group List](#)
- [Lines of Business](#)
- [Workers' Compensation Complaint and Request for Action/Appeals Contact Information](#)

- [Financial Statements PDF's](#)
- [Annual Statements](#)
- [Quarterly Statements](#)
- [Company Complaint](#)
- [Company Performance & Comparison Data](#)
- [Company Enforcement Action](#)
- [Composite Complaints Studies](#)

- [Additional Info](#)
- [Find A Company Representative In Your Area](#)
- [View Financial Disclaimer](#)

COMPANY PROFILE

Company Information

AMERICAN GUARANTEE AND LIABILITY INSURANCE COMPANY

**1299 ZURICH WAY
SCHAUMBURG, IL 60196
800-382-2150**

Old Company Names **Effective Date**

Agent For Service

KARISSA LOWRY
2710 GATEWAY OAKS DRIVE
SUITE 150N
SACRAMENTO CA 95833

Reference Information

NAIC #:	26247
California Company ID #:	1237-7
Date Authorized in California:	12/20/1939
License Status:	UNLIMITED-NORMAL
Company Type:	Property & Casualty
State of Domicile:	NEW YORK

[back to top](#)

NAIC Group List

NAIC Group #: 0212 ZURICH INS GRP

Lines Of Business

The company is authorized to transact business within these lines of insurance. For an explanation of any of these terms, please refer to the glossary.

- AIRCRAFT
- AUTOMOBILE
- BOILER AND MACHINERY
- BURGLARY
- COMMON CARRIER LIABILITY
- DISABILITY
- FIRE
- LIABILITY
- MARINE
- MISCELLANEOUS
- PLATE GLASS
- SPRINKLER
- SURETY
- TEAM AND VEHICLE
- WORKERS' COMPENSATION

[back to top](#)