

**SUBMITTAL TO THE BOARD OF SUPERVISORS
COUNTY OF RIVERSIDE, STATE OF CALIFORNIA**



ITEM: 3.46
(ID # 12464)

MEETING DATE:

Tuesday, June 30, 2020

FROM: TLMA-TRANSPORTATION:

SUBJECT: TRANSPORTATION AND LAND MANAGEMENT AGENCY/TRANSPORTATION:

Adopt Resolution No. 2020-129 and Resolution No. 2020-130 to Initiate Proceedings for the Annexation of Street Lighting Zone 138 to Landscaping and Lighting Maintenance District No. 89-1-Consolidated, Mead Valley, District 1. [\$1,821 Ongoing Cost - L&LMD No. 89 1 C 100%] (Set for Public Hearing on August 25, 2020) (Clerk to Advertise)

RECOMMENDED MOTION: That the Board of Supervisors:

1. Adopt Resolution No. 2020-129 a Resolution of the Board of Supervisors of the County of Riverside initiating proceedings for the annexation of Street Lighting Zone 138 to Landscaping and Lighting Maintenance District No. 89-1-Consolidated of the County of Riverside pursuant to the Landscaping and Lighting Act of 1972 and ordering preparation of the Engineer's Report regarding said annexation;

ACTION: Policy, Set for Hearing



Patricia Romo, Director of Transportation 6/15/2020

MINUTES OF THE BOARD OF SUPERVISORS

On motion of Supervisor Jeffries, seconded by Supervisor Hewitt and duly carried by unanimous vote, IT WAS ORDERED that the above matter is approved as recommended and the public hearing on the annexation of Street Lighting Zone 138 is set for August 25, 2020 at 9:30 a.m. or as soon as possible thereafter.

Ayes: Jeffries, Spiegel, Washington, Perez and Hewitt
Nays: None
Absent: None
Date: June 30, 2020
xc: Transportation

Kecia R. Harper
Clerk of the Board

By: 
Deputy

**SUBMITTAL TO THE BOARD OF SUPERVISORS COUNTY OF RIVERSIDE,
STATE OF CALIFORNIA**

2. Adopt Resolution No. 2020-130, a Resolution of the Board of Supervisors of the County of Riverside declaring its intent to order the annexation of Street Lighting Zone 138 to Landscaping and Lighting Maintenance District No. 89-1-Consolidated of the County of Riverside pursuant to the Landscaping and Lighting Act of 1972 for the maintenance and servicing of streetlights, adopting the preliminary Engineer's Report, giving notice of and setting the time and place of the public hearing on the annexation of Street Lighting Zone 138, ordering an assessment ballot proceeding conducted by mail, and directing the notice of public hearing and the assessment ballot to be mailed pursuant to said Act and Article XIID of the California Constitution and Section 4000 of the Elections Code; and

3. Set the public hearing on the annexation of Street Lighting Zone 138 for August 25, 2020, order a mailed assessment ballot proceeding; and direct notice of the public hearing and ballot be mailed pursuant to Article XIID of the California Constitution.

FINANCIAL DATA	Current Fiscal Year:	Next Fiscal Year:	Total Cost:	Ongoing Cost
COST	\$ 0	\$ 1,821	N/A	\$ 1,821
NET COUNTY COST	\$ 0	\$ 0	\$ 0	\$ 0
SOURCE OF FUNDS: L&LMD No. 89-1-C – 100% There are no General Funds used in this project.			Budget Adjustment: N/A	
			For Fiscal Year: 20/21	

C.E.O. RECOMMENDATION: Approve

BACKGROUND:

Summary

Landscaping and Lighting Maintenance Districts (L&LMDs) are formed for the purpose of creating a funding mechanism to pay for the installation and maintenance of landscaping, streetlights, traffic signals, runoff catch basin filters, decorative fencing, and other roadside features within the road right of way. Within an established L&LMD, zones are created for specific developments, a fee structure is developed specific to the features within that zone, and the zone is then assessed through a tax levy on an annual basis for the installation and maintenance of the features within that particular zone.

L&LMD No. 89-1-C was formed in 1994, Resolution No. 94-389, and currently consists of 166 individual zones with different fee structures spread throughout Riverside County. The commercial property owner of Plot Plan No. 180023, as described in the attached Exhibit "A", has petitioned the County to annex their property into L&LMD No. 89-1-C, creating Street Lighting Zone 138. The boundaries of Street Lighting Zone 138 will encompass the entire Plot Plan No. 180023 and will include the maintenance and servicing of streetlights.

**SUBMITTAL TO THE BOARD OF SUPERVISORS COUNTY OF RIVERSIDE,
STATE OF CALIFORNIA**

Adoption of Resolution No. 2020-129 appoints the Director of the Transportation Department, or her designee, as the Engineer to prepare a Report regarding the proposed annexation of Street Lighting Zone 138 to Landscaping and Lighting Maintenance District No. 89-1-Consolidated ("L&LMD No. 89-1-C").

Resolution No. 2020-130 declares the Board of Supervisors' intention of ordering the annexation of Street Lighting Zone 138 to L&LMD No. 89-1-C. The annexation of Street Lighting Zone 138 to L&LMD No. 89-1-C will fund the maintenance and servicing of streetlights within public right-of-way located east of Patterson Avenue, north of Rider Street and west of Harvill Ave in the Mead Valley area and includes one commercial parcel totalling 9.59 acres.

Consistent with the Board of Supervisors' direction regarding compliance with Article XIID of the California Constitution and the Landscaping and Lighting Act of 1972, the attached resolutions have been prepared and a public hearing scheduled for 9:30 a.m. on August 25, 2020 to receive testimony for and against the proposed assessment. Each property owner within the proposed Street Lighting Zone 138 will receive a notice of the public hearing and mail-in ballot, an impartial analysis, a copy of Resolution No. 2020-130, and an information sheet.

Ballots must be returned prior to the conclusion of the public hearing. If, at the time designated for the tabulation of the ballots, the ballots submitted in favor of the annexation and levy of the assessment exceed the ballots submitted in opposition of said annexation and levy, Street Lighting Zone 138 will be annexed to L&LMD No. 89-1-C.

There is only one individual/entity which owns all of the property within the proposed boundaries of Street Lighting Zone 138 and said property owner has executed a "Waiver and Consent Regarding Date of Assessment Ballot Election" allowing for the election and public hearing to be held on August 25, 2020.

Impact on Residents and Businesses

The new assessment is for the purpose of providing the maintenance and servicing of streetlights within public right-of-way.

Only the commercial property owners within the proposed boundaries of Street Lighting Zone 138, which are represented by Plot Plan No. 180023, as described in the attached Exhibit "A" (a two page exhibit containing a description and diagram) are impacted by the cost of this annexation. By setting up an assessment for the maintenance of certain infrastructure required by the development, the County requires that the development pay for its maintenance impact, rather than the obligation falling upon public funding sources.

SUPPLEMENTAL:

Additional Fiscal Information

**SUBMITTAL TO THE BOARD OF SUPERVISORS COUNTY OF RIVERSIDE,
STATE OF CALIFORNIA**

The proposed budget for fiscal year 2021-22 for Street Lighting Zone 138 is \$1,821.00. This will result in an assessment for fiscal year 2021-22 within Street Lighting Zone 138 of \$190.00 per acre. The annual assessment may be adjusted annually by the greater of 2% or the cumulative percentage increase in the Consumer Price Index for all Urban Consumers for electricity (CPI-U), if any, as it stands as of March of each year over the base index for March of 2021.

Contract History and Price Reasonableness

N/A

ATTACHMENTS:

Location Map

Exhibit A

Resolution No. 2020-129

Resolution No. 2020-130

Engineer's Report



Jason Farin, Principal Management Analyst 6/24/2020



Gregory V. Priamos, Director County Counsel 6/18/2020

2 RESOLUTION NO. 2020-130

3 RESOLUTION OF THE BOARD OF SUPERVISORS OF THE COUNTY OF RIVERSIDE DECLARING
4 ITS INTENT TO ORDER THE ANNEXATION OF STREET LIGHTING ZONE 138 TO LANDSCAPING
5 AND LIGHTING MAINTENANCE DISTRICT NO. 89-1-CONSOLIDATED OF THE COUNTY OF
6 RIVERSIDE PURSUANT TO THE LANDSCAPING AND LIGHTING ACT OF 1972 FOR THE
7 MAINTENANCE AND SERVICING OF STREETLIGHTS; ADOPTING THE PRELIMINARY
8 ENGINEER'S REPORT; GIVING NOTICE OF AND SETTING THE TIME AND PLACE OF THE
9 PUBLIC HEARING ON THE ANNEXATION OF STREET LIGHTING ZONE 138 ; ORDERING AN
10 ASSESSMENT BALLOT PROCEEDING CONDUCTED BY MAIL; AND DIRECTING NOTICE OF
11 THE PUBLIC HEARING AND THE ASSESSMENT BALLOT TO BE MAILED PURSUANT TO SAID
12 ACT AND ARTICLE XIID OF THE CALIFORNIA CONSTITUTION AND SECTION 4000 OF THE
13 ELECTIONS CODE

14 WHEREAS, the Board of Supervisors (hereinafter the "Board of Supervisors") of the County of
15 Riverside (hereinafter the "County") has adopted Resolution No. 2020-129 on June 30, 2020 initiating
16 proceedings for the annexation of Street Lighting Zone 138 (hereinafter "Street Lighting Zone 138"), as
17 described and shown in Exhibit "A", which is attached hereto and incorporated herein, to Landscaping
18 and Lighting Maintenance District No. 89-1-Consolidated of the County of Riverside, State of California,
19 (hereinafter "L&LMD No. 89-1-C") pursuant to the Landscaping and Lighting Act of 1972 (hereinafter the
20 "Act"), which is Part 2 (commencing with Section 22500) of Division 15 of the Streets and Highways Code
21 (hereinafter the "Streets and Highways Code"), and ordering the preparation of a report (hereinafter the
22 "Report") regarding the proposed annexation of Street Lighting Zone 138 and the assessments to be
23 levied within Street Lighting Zone 138 each fiscal year beginning fiscal year 2021-22 for the maintenance
24 and servicing of streetlights within the public right-of-way within said zone; and

25 WHEREAS, such proceedings shall comply with the requirements of Article XIID of the California
26 Constitution (hereinafter "Article XIID"), the Act, and Section 4000 of the Elections Code requiring voter
approval of the proposed assessment to be levied by L&LMD No. 89-1-C for Street Lighting Zone 138;
and

WHEREAS, the Board of Supervisors by Resolution No. 2020-129 directed the Director of the
Transportation Department, or her designee (hereinafter the "Engineer"), to prepare and file the Report

FORM APPROVED COUNTY COUNSEL
BY: MCT 18 JUN 20
MICHAEL C. THOMAS DATE

JUN 30 2020 3.46

1 with the Clerk of the Board of Supervisors in accordance with Sections 22608 and 22585 et. seq. of the
2 Streets and Highways Code and Section 4 of Article XIID; and

3 **WHEREAS**, said Engineer has filed the Report with the Clerk of the Board of Supervisors and the
4 Report has been presented to and considered by the Board of Supervisors; and

5 **WHEREAS**, the Applicant has executed a "Waiver and Consent Regarding Date of Assessment
6 Ballot Election" allowing for the election to be held on August 25, 2020; and

7 **WHEREAS**, it is necessary that the Board of Supervisors adopt a resolution of intention pursuant
8 to Section 22587 of the Streets and Highways Code, which fixes and gives notice, pursuant to Section
9 22588 of the Streets and Highways Code, of the time and place of a public hearing on said Report, the
10 annexation of Street Lighting Zone 138, and the assessments to be levied on parcels within Street
11 Lighting Zone 138 beginning in fiscal year 2021-22;

12 **NOW, THEREFORE, BE IT RESOLVED, FOUND, DETERMINED AND ORDERED** by the Board
13 of Supervisors in regular session assembled on June 30, 2020 as follows:

14 **Section 1. Findings.** The Board of Supervisors, after reviewing the Report, finds that:

- 15 (a) The foregoing recitals are true and correct;
- 16 (b) The Report contains all matters required by Sections 22565 through 22574 of the Streets
17 and Highways Code and Section 4 of Article XIID and may, therefore, be approved by the
18 Board of Supervisors;
- 19 (c) The annual assessment for fiscal year 2021-22 on all parcels within Street Lighting
20 Zone 138 will be \$190.00 per acre.

21 **Section 2. Intent.** The Board of Supervisors hereby declares its intention to order the
22 annexation of Street Lighting Zone 138, as described and shown in Exhibit "A", to L&LMD No. 89-1-C,
23 and to levy and collect an annual assessment on all assessable lots and parcels of property within Street
24 Lighting Zone 138 commencing with the fiscal year 2021-22 as set forth in the Report. The Report
25 expressly states that there are no parcels or lots within Street Lighting Zone 138 that are owned by a
26 federal, state or other local governmental agency that will benefit from the services to be financed by the

1 annual assessments. The annual assessments will be collected at the same time and in the same manner
2 as property taxes are collected, and all laws providing for the collection and enforcement of property
3 taxes shall apply to the collection and enforcement of said assessments.

4 **Section 3. Boundaries.** All the property within the boundaries of Street Lighting Zone 138 is
5 proposed to be annexed to L&LMD No. 89-1-C and shall include that property in the unincorporated area
6 of the County as described and shown in Exhibit "A".

7 **Section 4. Description of Services to be Provided .** The services authorized for Street
8 Lighting Zone 138 of L&LMD No. 89-1-C are:

- 9 (a) Providing electricity to and the maintenance and servicing of streetlights within the public
10 right-of-way including incidental costs and expenses.

11 **Section 5. Amount to be Levied.** The assessment to be levied upon each parcel that benefits
12 from the annexation of Street Lighting Zone 138 to L&LMD No. 89-1-C will be \$190.00 per acre for fiscal
13 year 2021-22. As stated in the Report, the total budget for Street Lighting Zone 138 for the fiscal year
14 2021-22 is \$1,821.00; there is 1 parcel that is to be assessed that aggregates to 9.59 acres. Each
15 succeeding fiscal year the special assessment may be subject to an annual adjustment that is the greater
16 of two percent (2%) or the cumulative percentage increase, if any, in the Consumer Price Index for all
17 Urban Consumers for electricity ("CPI-U-Electricity") for the Riverside-San Bernardino-Ontario California
18 Standard Metropolitan Statistical area ("Index") published by the Bureau of Labor Statistics of the United
19 States Department of Labor. The annual CPI-U-Electricity adjustment will be based on the cumulative
20 increase, if any, in the Index as it stands on March of each year over the base Index for March of 2021.
21 Any increase larger than the greater of 2% or the CPI-U-Electricity annual adjustment requires a majority
22 approval of all the property owners in Street Lighting Zone 138. The Board of Supervisors will levy the
23 assessment in each subsequent fiscal year until the Board of Supervisors undertakes proceedings for
24 the dissolution of Street Lighting Zone 138 of L&LMD No. 89-1-C. The annual assessment will fund the
25 services described in Section 4 of this Resolution. For further particulars, reference is to be made to the
26 Report on file in the Office of the Clerk of the Board of Supervisors.

1 **Section 6. The Property to be Annexed.** The property to be annexed to L&LMD No. 89-1-C
2 is Street Lighting Zone 138. The boundaries of Street Lighting Zone 138 are located within the
3 unincorporated area of the County and are described and shown in the Report and Exhibit "A".

4 **Section 7. Report.** The Report, which is on file with the Clerk of the Board of Supervisors and
5 which has been presented to the Board of Supervisors, is hereby approved. Reference is made to the
6 Report for a full and detailed description of the services, the boundaries of Street Lighting Zone 138, and
7 the annual assessment to be levied upon assessable lots and parcels within Street Lighting Zone 138
8 proposed to be annexed to L&LMD No. 89-1-C.

9 **Section 8. Public Hearing.** The question of whether Street Lighting Zone 138 shall be
10 annexed to L&LMD No. 89-1-C and an annual assessment levied beginning with fiscal year 2021-22 shall
11 be considered at a public hearing (hereinafter the "Public Hearing") to be held on August 25, 2020, at
12 9:30 a.m. at the meeting room of the Board of Supervisors of the County at 4080 Lemon Street, 1st Floor,
13 Riverside, California.

14 **Section 9. Majority Protest.** Each owner of record of property within Street Lighting Zone 138
15 is to receive by mail an assessment ballot that shall conform to the requirements of Section 4 of Article
16 XIID and Section 4000 of the California Elections Code. The assessment ballots are to be returned prior
17 to the Public Hearing. The agency shall not impose an assessment if there is a majority protest. A majority
18 protest exists if, upon the conclusion of the hearing, ballots submitted in opposition to the assessment
19 exceed the ballots submitted in favor of the assessment. In tabulating the ballots, the ballots shall be
20 weighted according to the proportional financial obligation of the affected property.

21 **Section 10. Information.** Any property owner desiring additional information regarding Street
22 Lighting Zone 138 of L&LMD No. 89-1-C, the Report, or the proposed assessment is to contact
23 Ms. Brigitte Hahn, Senior Engineering Technician, Transportation Department of the County of Riverside,
24 4080 Lemon Street, 8th Floor, Riverside, California, 92501, or by telephone at 951-955-6263, or by e-mail
25 at bhahn@rivco.org.
26

EXHIBIT "A"

DESCRIPTION OF BOUNDARIES

The boundaries of Street Lighting Zone 138 to be annexed into Landscaping and Lighting Maintenance District No. 89-1-Consolidated, of the County of Riverside, are coterminous with the boundaries of APN 317-170-046 as shown on Assessment Roll in the County of Riverside, State of California in Fiscal Year 2020-21.

1
2
3
4
5
6
7
8
9
10
11
12
13
14
15
16
17
18
19
20
21
22
23
24

STREET LIGHT ZONE 138
PORTION(S) OF SECTION 12, T.4.S., R.4W.
PLOT PLAN NO. 180023
1 PARCEL



The County of Riverside assumes no warranty or legal responsibility for the information contained on this map. Data and information represented on this map is subject to updates, modifications and may not be complete or appropriate for all purposes. County GIS and other sources should be queried for the most current information. Do not copy or resell this map. Printed by bhahn on 4/1/2020

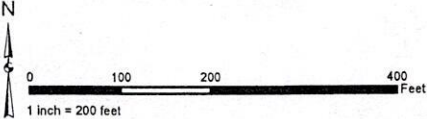

ASSESSMENT DIAGRAM

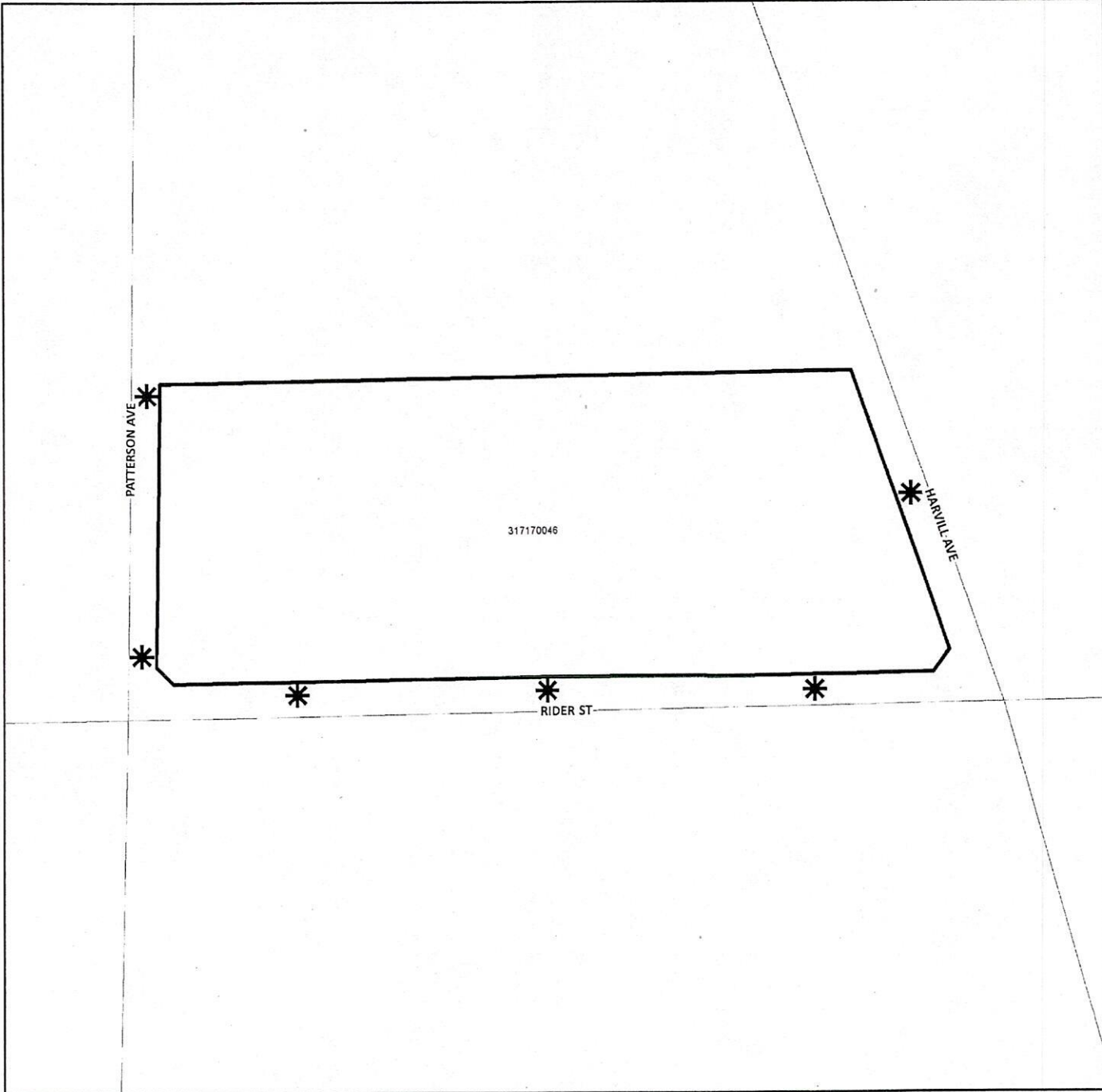

- * DENOTES MAINTAINED ROW STREETLIGHT
- ▭ DENOTES ZONE BOUNDARY

2 RESOLUTION NO. 2020-129

3 RESOLUTION OF THE BOARD OF SUPERVISORS OF THE COUNTY OF RIVERSIDE INITIATING
4 PROCEEDINGS FOR THE ANNEXATION OF STREET LIGHTING ZONE 138 TO LANDSCAPING
5 AND LIGHTING MAINTENANCE DISTRICT NO. 89-1-CONSOLIDATED OF THE COUNTY OF
6 RIVERSIDE PURSUANT TO THE LANDSCAPING AND LIGHTING ACT OF 1972 AND ORDERING
7 PREPARATION OF ENGINEER'S REPORT REGARDING SAID ANNEXATION

8 WHEREAS, the Board of Supervisors (hereinafter the "Board of Supervisors") of the County of
9 Riverside (hereinafter the "County") has been advised by the Riverside County Transportation
10 Department (hereinafter "Department") that said Department has received an application from the owner
11 (the "Applicant") of all the property within the unincorporated area of the County (hereinafter "Street
12 Lighting Zone 138"), as shown and described in Exhibit "A", which is attached hereto and made a part
13 hereof, to be annexed to Landscaping and Lighting Maintenance District No. 89-1-Consolidated
14 (hereinafter "L&LMD No. 89-1-C") of the County of Riverside, State of California, and the Board of
15 Supervisors has determined that it is necessary and desirable to initiate proceedings for the annexation
16 of Street Lighting Zone 138 to L&LMD No. 89-1-C pursuant to the Landscaping and Lighting Act of 1972,
17 Part 2 (commencing with Section 22500) of Division 15 of the Streets and Highways Code (hereinafter,
18 respectively, the "Act" and the "Streets and Highways Code"); and

19 WHEREAS, such proceedings shall comply with the requirements of Article XIID of the California
20 Constitution and Section 4000 of the Elections Code requiring voter approval of the proposed assessment
21 to be levied by L&LMD No. 89-1-C for Street Lighting Zone 138; and

22 WHEREAS, the Applicant has executed a "Waiver and Consent Regarding Date of Assessment
23 Ballot Election" allowing for the election to be held on August 25, 2020; and

24 WHEREAS, the Director of the Department, or her designee, is a licensed and registered civil
25 engineer, has expertise with respect to the formation and annexation of territory to landscaping and
26 lighting maintenance districts and the levying of assessments for said purposes and, therefore, is able to

FORM APPROVED COUNTY COUNSEL
BY MCT 18JUN20 DATE
MICHAEL C. THOMAS

JUN 30 2020 3.46

1 serve as the engineer (hereinafter the "Engineer") for the County with regard to the annexation of Street
2 Lighting Zone 138 to L&LMD No. 89-1-C.

3 **NOW, THEREFORE, BE IT RESOLVED, FOUND, DETERMINED AND ORDERED** by the Board
4 of Supervisors of the County of Riverside assembled in regular session on June 30, 2020 as follows:

5 **Section 1. Recitals.** The Board of Supervisors hereby finds and determines that all
6 the above recitals are true and correct.

7 **Section 2. Annexation.** The Board of Supervisors proposes to annex Street Lighting
8 Zone 138 to L&LMD No. 89-1-C and to initiate and conduct proceedings therefor pursuant to the Act for
9 the purpose of levying an annual assessment on all parcels within Street Lighting Zone 138 to pay the
10 costs of the following services:

- 11 (a) Providing electricity to and the maintenance and servicing of streetlights within the
12 public right-of-way including incidental costs and expenses.

13 **Section 3. Boundaries and Designation.** The boundaries of Street Lighting
14 Zone 138 that are proposed to be annexed to L&LMD No. 89-1-C shall include all of the property as
15 shown and described in Exhibit "A".

16 **Section 4. Report.** The Director of the Department, or her designee, is hereby
17 designated Engineer and is ordered to prepare and file a report with the Clerk of the Board of Supervisors
18 in accordance with Sections 22608 and 22585 et. seq. of the Streets and Highways Code and Section 4
19 of Article XIII D of the California Constitution.

20 **Section 5. Effective date.** This Resolution shall take effect from and after its date of
21 adoption.

2 **RESOLUTION 2020-129**

3 **RESOLUTION OF THE BOARD OF SUPERVISORS OF THE COUNTY OF**
4 **RIVERSIDE INITIATING PROCEEDINGS FOR**
5 **THE ANNEXATION OF STREET LIGHTING ZONE 138 TO LANDSCAPING AND**
6 **LIGHTING MAINTENANCE DISTRICT NO. 89-1-CONSOLIDATED OF THE COUNTY**
7 **OF RIVERSIDE PURSUANT TO THE LANDSCAPING AND LIGHTING ACT OF 1972**
8 **AND ORDERING PREPARATION OF ENGINEER'S REPORT REGARDING SAID**
9 **ANNEXATION**

8 ADOPTED by Riverside County Board of Supervisors on JUNE 30, 2020.

9 ROLL CALL:

10 Ayes: Jeffries, Spiegel, Washington, Perez and Hewitt
11 Nays: None
12 Absent: None

13
14
15 The foregoing is certified to be a true copy of a resolution duly adopted by said Board of
16 Supervisors on the date therein set forth.

17 KECIA R. HARPER, Clerk of said Board

18 By: 
19 Deputy

EXHIBIT "A"

DESCRIPTION OF BOUNDARIES

The boundaries of Street Lighting Zone 138 to be annexed into Landscaping and Lighting Maintenance District No. 89-1-Consolidated, of the County of Riverside, are coterminous with the boundaries of APN 317-170-046 as shown on Assessment Roll in the County of Riverside, State of California in Fiscal Year 2020-21.

1
2
3
4
5
6
7
8
9
10
11
12
13
14
15
16
17
18
19
20
21
22
23
24

LANDSCAPING AND LIGHTING MAINTENANCE DISTRICT NO. 89-1 CONSOLIDATED

STREET LIGHT ZONE 138
PORTION(S) OF SECTION 12, T.4.S., R.4W.
PLOT PLAN NO. 180023
1 PARCEL



The County of Riverside assumes no warranty or legal responsibility for the information contained on this map. Data and information represented on this map is subject to updates, modifications and may not be complete or appropriate for all purposes. County GIS and other sources should be queried for the most current information. Do not copy or resell this map. Printed by bhahn on 4/1/2020

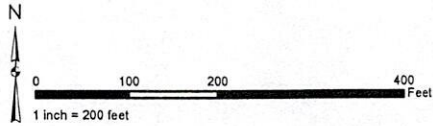

ASSESSMENT DIAGRAM

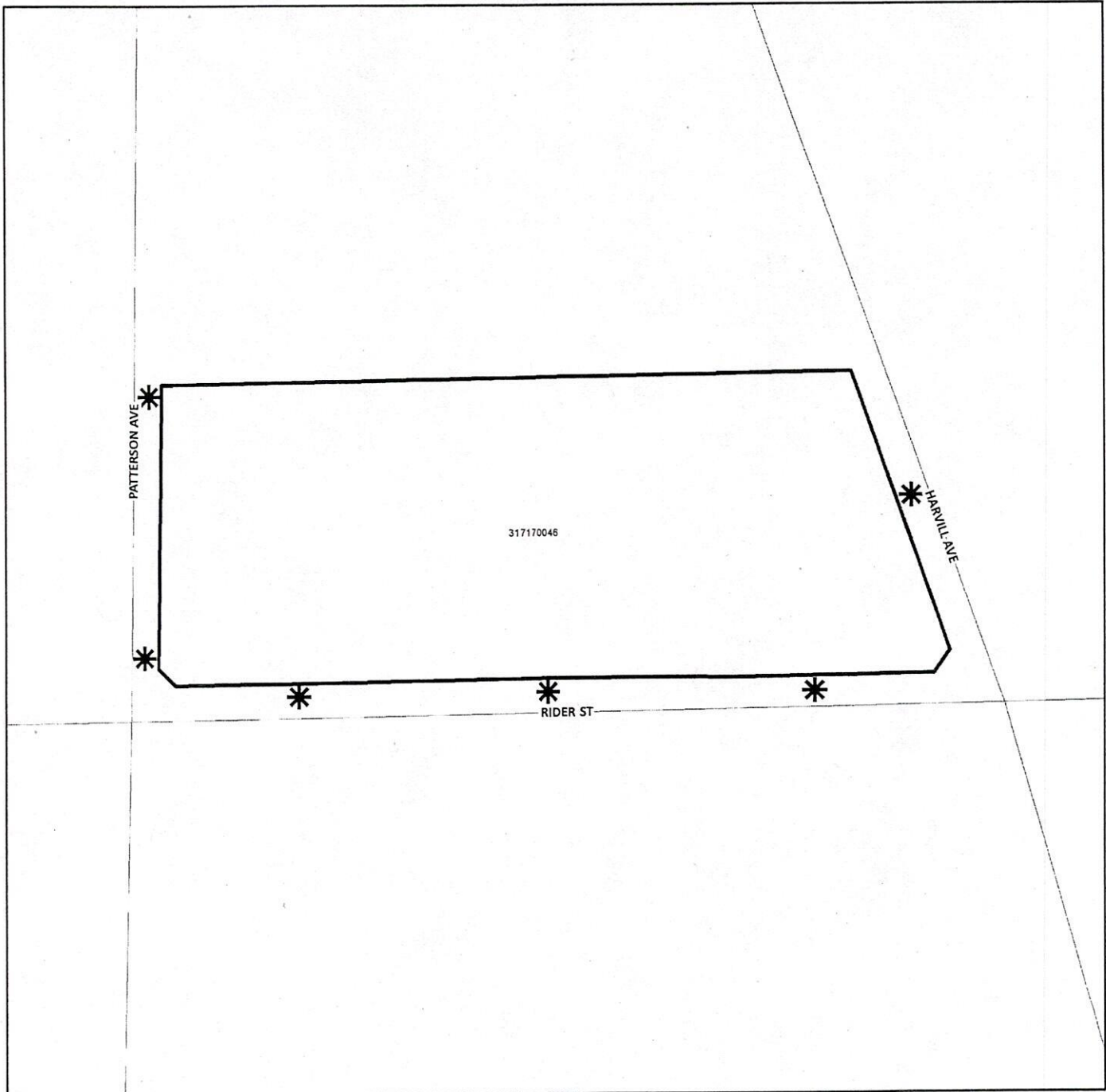

- * DENOTES MAINTAINED ROW STREETLIGHT
- ▭ DENOTES ZONE BOUNDARY



COUNTY OF RIVERSIDE - TRANSPORTATION AND LAND MANAGEMENT AGENCY

**ENGINEER'S REPORT FOR
LANDSCAPING AND LIGHTING MAINTENANCE
DISTRICT NO. 89-1-CONSOLIDATED
ANNEXATION OF STREET LIGHTING ZONE 138
PP 180023**

May 2020

PREPARED BY



Harris & Associates

*41593 Winchester Rd, Suite 200
Temecula, CA 92590
www.weareharris.com*

TABLE OF CONTENTS

Engineer's Certification.....	i
Executive Summary.....	1
A. Introduction.....	1
B. Description of Street Lighting Assessment Zone.....	2
Part I – Plans and Specifications	3
A. Description of Improvements and Services for L&LMD No. 89-1-C	3
B. Improvements and Services for L&LMD No. 89-1-C STL Zone 138.....	4
C. Location of the Street Lighting Assessment Zone.....	4
Part II – Method of Apportionment.....	5
A. Benefit Analysis.....	5
B. Maximum Assessment Methodology	7
C. Annual Assessment.....	8
Part III – Cost Estimate.....	10
Part IV – Assessment Diagram/Boundary Map	11
Part V – Assessment Roll.....	14
Waiver and Consent.....	15



ENGINEER'S CERTIFICATION

AGENCY: COUNTY OF RIVERSIDE, CALIFORNIA – TRANSPORTATION DEPARTMENT

PROJECT: ANNEXATION OF PP 180023 TO
LANDSCAPING AND LIGHTING MAINTENANCE DISTRICT NO.
89-1-CONSOLIDATED (“L&LMD NO. 89-1-C”) AS STREET LIGHTING ZONE 138
PP 180023

TO: BOARD OF SUPERVISORS
COUNTY OF RIVERSIDE
STATE OF CALIFORNIA

ENGINEER'S REPORT

Pursuant to the provisions of Section 22565 through 22574 of the Landscaping and Lighting Act of 1972 (“1972 Act”), said Act being Part 2 of Division 15 of the Streets and Highways Code of the State of California, Section 4 of Article XIII D of the California Constitution, and direction from the Board of Supervisors of Riverside County, California, I submit herewith the following Engineer’s Report (“Report”), consisting of five parts.

This Report provides for the annexation of Plot Plan 180023 (PP 180023) to L&LMD No. 89-1-C as Street Lighting Zone 138 (STL Zone 138) and establishes the Maximum Assessment to be levied in the Fiscal Year commencing on July 1, 2021 and ending on June 30, 2022 (2021-2022) and continuing in all subsequent Fiscal Years, for this area to be known and designated as:

L&LMD NO. 89-1-C STL ZONE 138 **PP 180023**

I do hereby assess and apportion the total amount of the costs and expenses upon several parcels of land within said designated area liable therefor and benefited thereby, in proportion to the estimated benefits that each parcel receives, respectively, from said services.

NOW, THEREFORE, I, the appointed ENGINEER, acting on behalf of the County of Riverside Transportation Department, pursuant to the 1972 Act, do hereby submit the following:

Pursuant to the provisions of law, the costs and expenses of STL Zone 138 have been assessed upon the parcels of land in STL Zone 138 benefited thereby in direct proportion and relation to the estimated benefits to be received by each of said parcels. For particulars as to the identification of said parcels, reference is made to the Assessment Diagram/Boundary Map, a reduced copy of which is included herein.

As required by law, an Assessment Diagram/Boundary Map is filed herewith, showing STL Zone 138, as well as the boundaries and dimensions of the respective parcels and subdivisions of land within said STL Zone 138 as they exist as of the date of this Report, each of which subdivisions of land or parcels or lots, respectively, have been assigned a parcel/lot number within a specific tract and indicated on said Assessment Diagram/Boundary Map and in the Assessment Roll contained herein.

The separate numbers given the subdivisions and parcels of land, as shown on said Assessment Diagram/Boundary Map and Assessment Roll, correspond with the numbers assigned to each parcel by the Riverside County Assessor. Reference is made to the County Assessor Parcel Map for a description of the lots or parcels.

As of the date of this Report, there are no parcels or lots within STL Zone 138 that are owned by a federal, state or other local governmental agency that will benefit from the services to be provided by the assessments to be collected.

DATED this 29th day of May 2020



K. Dennis Klingelhofer, P.E., Assessment Engineer
R.C.E. No. 50255
Engineer of Work
County of Riverside
State of California



EXECUTIVE SUMMARY

A. Introduction

Pursuant to the provisions of law, the costs and expenses of STL Zone 138 have been assessed upon the parcels of land in STL Zone 138 benefited thereby in direct proportion and relation to the estimated benefits to be received by each of said parcel(s). For particulars as to the identification of said parcel(s), reference is made to the Assessment Diagram/Boundary Map, a reduced copy of which is included herein. On this 30th day of June, 2020, the Riverside County Board of Supervisors, County of Riverside, State of California, ordering the preparation of the Report providing for the annexation of PP 180023 to L&LMD No. 89-1-C as STL Zone 138 did, pursuant to the provisions of the 1972 Act, being Division 15 of the Streets and Highways Code of the State of California, adopt Resolution No. 2020-129 for a special assessment district zone known and designated as:

STL ZONE 138
PP 180023

The annexation of STL Zone 138 includes the parcel(s) of land within the commercial development known as PP 180023, also identified by the Assessor Parcel Number(s) valid as of the date of this Report:

317-170-046

Harris & Associates submits this Report, consisting of (5) parts, for the annexation of said STL Zone 138 and the establishment of the Maximum Assessment to be levied and collected commencing Fiscal Year 2021-2022 and continuing in subsequent fiscal years.

Part I

Plans and Specifications: This section contains a description of STL Zone 138's boundaries and the proposed improvements within said STL Zone 138 ("Plans" as described in Part I). STL Zone 138 shall consist of a benefit zone encompassing all of the properties within the commercial development known as PP 180023.

Part II

The Method of Apportionment: A narrative of the property benefits from the improvements and the method of calculating each property's proportional special benefit and annual assessment. The proposed initial Maximum Assessment and assessment range formula established for STL Zone 138 is based on current property development Plans and estimated annual costs and expenses associated with all improvements to be accepted and maintained by STL Zone 138 at build-out.



Part III

The Cost Estimate: An estimate of the cost of streetlight maintenance, including incidental costs and expenses in connection therewith for Fiscal Year 2021-2022, is as set forth on the lists thereof, attached hereto.

Part IV

Assessment Diagram/Boundary Map: The Assessment Diagram/Boundary Map shows the parcels of land included within the boundaries of STL Zone 138. For details concerning the lines and dimensions of the applicable Assessor's Parcel Number(s), refer to the Riverside County Assessor's Map(s) as of the date of this Report.

Part V

Assessment Roll: Separate numbers given the subdivisions and parcels of land/lots and the initial Maximum Assessment per parcel or lot to be applied on the tax roll for Fiscal Year 2021-2022.

B. Description of Street Lighting Assessment Zone

The services to be provided by L&LMD No. 89-1-C STL Zone 138 include public street lighting which provides a special benefit to the parcel(s) to be assessed. The annexation of PP 180023 to L&LMD No. 89-1-C as STL Zone 138 will provide the financial mechanism (annual assessments) by which the ongoing operation and maintenance of these improvements and services will be funded. STL Zone 138's structure, proposed improvements, method of apportionment and assessments described in this Report are based on the Plans provided to Harris & Associates as of the date of this Report, including all estimated direct expenditures, incidental expenses, and reserves associated with the energizing, maintenance and servicing of the proposed improvements.



PART I – PLANS AND SPECIFICATIONS

A. Description of Improvements and Services for L&LMD No. 89-1-C

The following services were authorized pursuant to the County of Riverside Board of Supervisors approved Resolution No. 94-389 for L&LMD No. 89-1-C:

- L&LMD No. 89-1-C will annually levy an assessment on property within its boundaries to pay the cost of the following services and improvements in proportion to the special benefit provided to the parcels to be assessed:
 - The installation and planting of landscaping, including trees, shrubs, grass and other ornamental vegetation;
 - The installation or construction of statuary, fountains and other ornamental structures and facilities;
 - The installation or construction of public lighting facilities including but not limited to, traffic signals;
 - The installation or construction of any facilities which are appurtenant to any of the foregoing, or which are necessary or convenient for the maintenance or servicing thereof, including, but not limited to, grading, clearing, removal of debris, the installation or construction of curbs, gutters, walls, sidewalks or paving, water irrigation, drainage or electrical facilities; and,
 - The maintenance and/or servicing of any of the foregoing.

- The street lighting improvements to be funded by L&LMD No. 89-1-C STL Zone 138 generally includes the maintenance and servicing of:
 - Streetlights within the public right-of-way which were required to be installed as a condition of approval necessary for development of properties within the Street Lighting Assessment Zone 138.



B. Improvements and Services for L&LMD No. 89-1-C STL Zone 138

The services to be funded by L&LMD No. 89-1-C STL Zone 138 include the maintenance and servicing of 6 public streetlights adjacent to the parcel within the public right-of-way known as:

- Patterson Avenue.
- Rider Street.
- Harvill Avenue.

The proposed improvements described in this Report are based on current development and improvement plans provided to Harris & Associates as of the date of this Report. Improvement plans include the (1) Unapproved Rider Commerce Center Site Plan by RGA Office of Architectural Design, dated 02/07/2019 and (2) Approved Street Light Location Plan for Plot Plan No. 180023, IP No. 190028 by Huitt-Zollars, Inc., signed by Riverside County Oversight Engineer No. 44701 on 10/02/2019 ("Plans").

C. Location of Street Lighting Assessment Zone

STL Zone 138 is located within the unincorporated area of the County of Riverside, State of California and is comprised of PP 180023. The area for STL Zone 138 is generally located north of Rider Street, south of Cajalco Road, east of Patterson Avenue and west of Harvill Avenue. At full development, STL Zone 138 is projected to include one (1) assessable commercial lot/unit and zero (0) non-assessable lots/units. STL Zone 138 currently consists of the lot(s)/unit(s), parcel(s) and subdivisions of land located in the following development area:

- PP 180023 – Assessor Parcel Number(s) as of the date of this Report:

317-170-046



PART II – METHOD OF APPORTIONMENT

A. Benefit Analysis

The 1972 Act permits the establishment of assessment districts by agencies for the purpose of providing certain public improvements, which include the construction, maintenance, and servicing of public lights, landscaping, dedicated easements for landscape use, and appurtenant facilities. The 1972 Act further provides that assessments may be apportioned upon all assessable lots or parcels of land within an assessment district in proportion to the estimated benefits to be received by each lot or parcel from the improvements rather than by assessed value.

Section 22573 of the 1972 Act gives the following instructions for apportioning assessments to the parcels within the district:

“The net amount to be assessed upon lands within an assessment district may be apportioned by any formula or method which fairly distributes the net amount among all assessable lots or parcels in proportion to the estimated benefits to be received by each such lot or parcel from the improvements.”

In addition, Article XIII D of the California Constitution (“Article”) requires that a parcel's assessment may not exceed the reasonable cost of the proportional special benefit conferred on that parcel. The Article provides that only special benefits are assessable, and the County must separate the general benefits from the special benefits conferred on a parcel. A special benefit is a particular and distinct benefit over and above general benefits conferred on the public at large, including real property within the district. The general enhancement of property value does not constitute a special benefit.

The proposed improvements, the associated costs, and assessments have been carefully reviewed, and allocated based on the special benefit received by the parcels to be assessed as required by the 1972 Act and Article XIII D as described in the following section.

Special Benefit

The street lighting improvements within STL Zone 138 provide direct and special benefit to the lots or parcels within STL Zone 138. Therefore, the maintenance of these improvements also provides direct and special benefit by maintaining the functionality of the improvements and allowing the improvements to operate in a proper manner.



Public streetlights confer particular and distinct special benefits upon developable parcels within the District because of the nature of the improvements. The servicing of streetlights, and appurtenant facilities, specially benefit parcels within the District by allowing for the development of the parcel(s) and the economic benefit which results from the development. Installation and ongoing maintenance of the streetlights will provide safety for employees and customers, reduced property-related crimes (especially vandalism), and increased traffic safety for ingress and egress to the parcel(s) by improving visibility. Streetlights also help to define public rights-of-way for the safety of pedestrians and motorists by defining a specific path during all hours of the day.

The installation and maintenance of streetlights within the public right-of-way adjacent to STL Zone 138 provide a safer street environment for owners of the parcels served. Therefore, the installation of streetlights is for the express, special benefit of the parcel(s) within STL Zone 138.

Finally, the proper maintenance of public streetlights, and appurtenant structures, provides an enhanced quality of life and sense of well-being for owner(s) of properties within STL Zone 138.

STL Zone 138 does not include government-owned parcels or easements, utility easements, and flood channel parcels.

Special Benefits of Landscaping and Lighting Maintenance District No. 89-1-C STL Zone 138 Authorized Improvements and Services:

The special benefits of street lighting are the provision of energy, convenience, safety, security of property, improvements and goods, specifically:

- Increased nighttime safety on roads and streets.
- Improved ability of pedestrians and motorists to see during the hours of darkness.
- Improved ingress to and egress from property.
- Reduced vandalism and other criminal acts and damage to improvements or property.
- Improved traffic circulation and reduced nighttime accidents and personal property loss.

General Benefit

The total benefit from the works of improvement is a combination of the special benefits to the parcels within the STL Zone 138 and the general benefits to the public at large and to adjacent property owners. A portion of the total maintenance costs for the public street lighting, if any, associated with general benefits cannot not be assessed to the parcels in the STL Zone 138, but would be paid from other Riverside County Transportation Department funds. Because the public streetlight improvements are located immediately adjacent to properties within the STL Zone 138 and were required as a condition of approval for the development of the property, and are maintained solely for the benefit of the properties within the STL Zone 138, any benefit received by



properties outside of the STL Zone 138 is nominal. Therefore, the general benefit portion of the benefit received from the improvements for the STL Zone 138 is zero.

Summary

In summary, no property is assessed in excess of the reasonable cost of the proportional special benefit conferred on that property. Additionally, benefits received by each parcel within STL Zone 138 are proportional to the lot size. Therefore, the proportionate share of the costs and expenses for the maintenance and servicing of the streetlights are apportioned on a per acre basis for all benefiting parcels within STL Zone 138.

B. Maximum Assessment Methodology

The following methodology for establishing the Maximum Annual Assessment was adopted by Riverside County Board of Supervisors in the annual Report approved on November 29, 1994. Such methodology has been maintained in preparation of this Report. The purpose of establishing a Maximum Annual Assessment formula is to provide for reasonable increases and inflationary adjustments to annual assessments without requiring costly noticing and mailing procedures, which would add to STL Zone 138 costs and assessments.

The Maximum Annual Assessment formula shall be applied to all assessable parcels of land within STL Zone 138. For STL Zone 138, the initial Maximum Assessment for Fiscal Year 2021-2022 is as follows:

- The initial Maximum Assessment established within STL Zone 138 (PP 180023) shall be \$1,821.
- The initial Maximum Assessment per acre established within STL Zone 138 (PP 180023) shall be \$190 per acre.

The initial Maximum Assessment shall be adjusted by the greater of two percent (2%) or the cumulative percentage increase in the Consumer Price Index for all Urban Consumers for Electricity ("CPI-U-E") for Riverside-San Bernardino-Ontario California Standard Metropolitan Statistical Area ("Index") published by the Bureau of Labor Statistics of the United States Department of Labor (BLS). The annual CPI-U-E adjustment will be based on the cumulative increase, if any, in the Index as it stands in March of each year over the base Index of 2021, starting in Fiscal Year 2022-2023.

The Maximum Assessment is adjusted annually and is calculated independent of the STL Zone 138's annual budget and proposed annual assessment. The proposed annual assessment (rate per acre) applied in any fiscal year is not considered to be an increased assessment if less than or equal to the



Maximum Assessment amount. In no case shall the annual assessment exceed the Maximum Assessment.

Although the Maximum Assessment will increase each year, the actual STL Zone 138 assessments may remain virtually unchanged. The Maximum Assessment adjustment is designed to establish a reasonable limit on STL Zone 138 assessments. The Maximum Assessment calculated each year does not require or facilitate an increase to the annual assessment and neither does it restrict assessments to the adjusted maximum amount. If the budget and assessments for the fiscal year require an increase and the increase is more than the adjusted Maximum Assessment, it is considered an increased assessment.

To impose an increased assessment, the County of Riverside must comply with the provisions of the California Constitution Article XIII D Section 4c, that requires a public hearing and certain protest procedures including mailed notice of the public hearing and property owner protest balloting. Property owners, through the balloting process, must approve the proposed assessment increase. If the proposed assessment is approved, then a new Maximum Assessment is established for STL Zone 138. If the proposed assessment is not approved, the County may not levy an assessment greater than the adjusted Maximum Assessment previously established for STL Zone 138.

C. Annual Assessment

The Method of Apportionment of the Assessment is based upon the relative special benefit derived from the improvements and conferred upon the assessable real property within STL Zone 138 over and above general benefit conferred upon the assessable real property within STL Zone 138 or to the public at large. The benefits received by each parcel within STL Zone 138 would be in proportion to the lot size. Therefore, the proportionate share of the costs and expenses for the maintenance and servicing of the streetlights are apportioned on a per acre basis for all benefiting parcels within STL Zone 138. Any Exempt Property within STL Zone 138 is specifically excluded from the apportionment calculation and is exempt from assessment.

The Assessment Rate per Acre within STL Zone 138 is calculated by dividing the total Annual Balance to Levy by the total Net Assessable Acres. The Assessment Rate per Acre is multiplied times the Net Assessable Acres of each parcel that is not Exempt. Total STL Zone 138 acres less Exempt Property acres, if any, equals total Net Assessable Acres. The Annual Balance to Levy is the Total Annual Street Lighting Costs as seen in Part III – Cost Estimate.



The Assessment Rate per Acre is calculated as follows:

Total Zone 138 Acres	9.59
Less: Exempt Property Acres	0
Net Assessable Acres	9.59

Annual Balance to Levy	\$1,821	= \$190	Assessment Rate per Acre
Total Net Assessable Acres	9.59		

The Assessment for each Assessable Parcel for FY 2021-2022 is calculated as follows:

Assessment Rate per Acre × Acreage of each parcel that is not Exempt = Annual Assessment for each Assessable Parcel.



PART III – COST ESTIMATE

L&LMD NO. 89-1-C STL ZONE 138 (PP 180023) FOR FISCAL YEAR 2021-2022

Cost Description	Total Costs for STL Zone 138 ^{2,3}	Cost per Acre for STL Zone 138 ^{3,4}
Annual Energy Charge of \$235.90 per Streetlight For 2 Streetlights – 16,500 Lumen 90 Watt LPSV ¹	\$472	\$108
Annual Energy Charge of \$257.94 per Streetlight For 4 Streetlights – 22,500 Lumen 135 Watt LPSV ¹	\$1,032	\$49
Maintenance Total	\$1,504	\$157
Administrative Costs	\$242	\$25
Contingency	\$75	\$8
Total Annual Street Lighting Costs	\$1,821	\$190

Initial Maximum Assessment for STL Zone 138⁵	\$1,821
--	----------------

¹ LPSV mean Low Pressure Sodium Vapor.

² Projected base rates of services for Fiscal Year 2021-2022 were provided by the County of Riverside Transportation Department.

³ Total costs and cost per acre rounded to whole dollars.

⁴ Based on 9.59 Net Assessable Acres which is subject to change based on future parcel configuration.

⁵ The initial Maximum Assessment shall be adjusted annually by the greater of two percent or the cumulative percentage increase in the CPI-U-E Index published by the BLS.

PART IV – ASSESSMENT DIAGRAM/BOUNDARY MAP

Part IV – Assessment Diagram/Boundary Map

Fiscal Year 2021-2022 L&LMD NO. 89-1-C STL ZONE 138

The Assessment Diagram/Boundary Map for STL Zone 138 by this reference is incorporated and made a part of this Report. Only the parcels identified within STL Zone 138 Assessment Diagram are within said boundary.

If any parcel submitted for collection is identified by the County Auditor Controller to be an invalid parcel number for the current fiscal year, a corrected parcel number and/or new parcel number will be identified and resubmitted to the County Auditor Controller. The assessment amount to be levied and collected for the resubmitted parcel or parcels shall be based on the method of apportionment and assessment rate approved in this Report. Therefore, if a single parcel has changed to multiple parcels, the assessment amount applied to each of the new parcels shall be according to the approved method of apportionment and assessment rate rather than a proportionate share of the original assessment.

Information identified on this Assessment Diagram/Boundary Map was provided by the Riverside County Transportation Department.

The STL Zone 138 Assessment Diagram/Boundary Map identifying the boundaries of parcels within PP 180023 in L&LMD No. 89-1-C STL Zone 138 is included in this Report for reference on the following page. For details concerning the lines and dimensions of the applicable Assessor's Parcel Numbers, refer to the County Assessor's Maps as of the date of this Report.

LANDSCAPING AND LIGHTING MAINTENANCE DISTRICT NO. 89-1 CONSOLIDATED

STREET LIGHT ZONE 138
PORTION(S) OF SECTION 12, T.4.S., R.4W.
PLOT PLAN NO. 180023
1 PARCEL



The County of Riverside assumes no warranty or legal responsibility for the information contained on this map. Data and information represented on this map is subject to updates, modifications and may not be complete or appropriate for all purposes. County GIS and other sources should be queried for the most current information. Do not copy or resell this map. Printed by bhahn on 4/1/2020

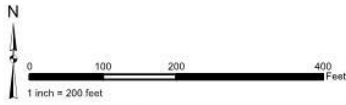

ASSESSMENT DIAGRAM

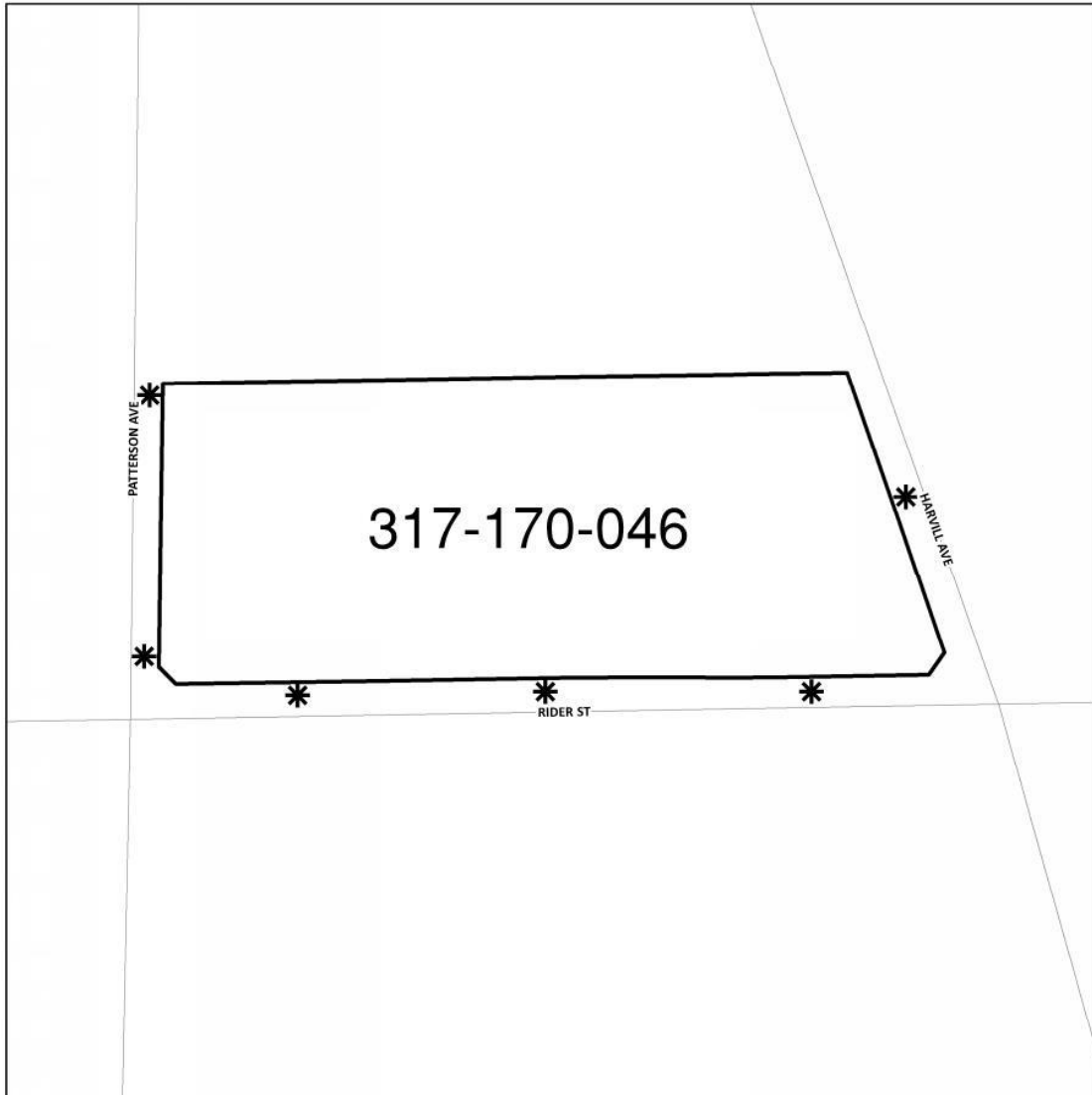

- * DENOTES MAINTAINED ROW STREETLIGHT
- DENOTES ZONE BOUNDARY



PART V – ASSESSMENT ROLL

Parcel identification for each lot/unit or parcel within STL Zone 138 shall be the parcel as shown on the Riverside County Secured Roll for the year in which this Report is prepared and reflective of the Assessor's Parcel Maps. STL Zone 138 includes the following APN(s) as of the date of this Report:

317-170-046

The initial Maximum Assessment for STL Zone 138 is as follows:

**L&LMD NO. 89-1-C STL ZONE 138
 (PP 180023)
 PROPOSED FISCAL YEAR 2021-2022 MAXIMUM ASSESSMENT¹**

PP	Assessor Parcel Number/ Lot No.	Acres	Maximum Assessment
PP 180023	317-170-046	9.59	\$1,821
Total		9.59	\$1,821

¹ The initial Maximum Assessment shall be adjusted annually by the greater of two percent or the cumulative percentage increase in the CPI-U-E Index published by the BLS.



WAIVER AND CONSENT

Waiver and Consent Regarding Date of Assessment Ballot Election

There is one entity which owns all of the property within the proposed boundaries of STL Zone 138. Said property owner has executed a "Waiver and Consent Regarding Date of Assessment Ballot Election" allowing for the election and public hearing to be held on August 25, 2020. A copy of said waiver is filed herewith and made a part hereof as seen on the following page.

WAIVER AND CONSENT

**LANDSCAPING AND LIGHTING MAINTENANCE
DISTRICT NO. 89-1-CONSOLIDATED
OF THE COUNTY OF RIVERSIDE, CALIFORNIA**

**WAIVER AND CONSENT REGARDING DATE OF
ASSESSMENT BALLOT ELECTION**

The undersigned, an authorized representative of Rider Commerce, LLC (the "Owner") owns property within the unincorporated area of the County of Riverside (the "County") represented by the following Assessor's Parcel Numbers for fiscal year 2020-21 (the "Property"): APN(s) 317-170-046.

The Owner has made application that the Property be annexed as Street Lighting Zone 138 to Landscaping and Lighting Maintenance District No. 89-1-Consolidated of the County ("L&LMD No. 89-1-C") and certifies the following:

1. The Owner waives the requirements of Section 4000 of the Elections Code of the State of California (the "Elections Code") that the mailed ballot election required for annexation and the levy of an annual assessment must be held on an established mailed ballot election date pursuant to Section 1500 of the Election Code; and
2. The Owner consents to the mailed assessment ballot election with respect to the levy of an annual assessment on the Property being held on August 25, 2020

OWNER: Rider Commerce, LLC
(Name of Company
as Stated in Initial Paragraph)

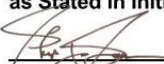
By: 
Signature

Name: Philip J Prassas
Print

Title: 4.24.20

THE PRESS-ENTERPRISE

DATE	ORDER NUMBER	PONumber	PRODUCT	SIZE	Amount
8/6/20	0011402637		PE Riverside	4 x 91 Li	1,362.40
8/6/20	0011402637		PE Riverside	4 x 91 Li	473.20

Invoice text: NOH - Resolution No. 2020-130

*TCMA - Transportation
 Item 3.46 of
 6/30/20*

Placed by: Hannah Lumanauw

Legal Advertising Memo Invoice

BALANCE DUE
1,835.60

SALES/CONTACT INFORMATION	ADVERTISER INFORMATION			
Nick Eller 951-368-9229	BILLING DATE	BILLED ACCOUNT NUMBER	ADVERTISER/CLIENT NUMBER	ADVERTISER/CLIENT NAME
	08/06/2020	5209148	5209148	BOARD OF SUPERVISORS



THE PRESS-ENTERPRISE
 Legal Advertising Memo Invoice

PLEASE DETACH AND RETURN THIS PORTION WITH YOUR REMITTANCE

ADVERTISER/CLIENT NAME		
BOARD OF SUPERVISORS		
BILLING DATE	BILLED ACCOUNT NUMBER	ADVERTISER/CLIENT NUMBER
08/06/2020	5209148	5209148
BALANCE DUE	ORDER NUMBER	TERMS OF PAYMENT
1,835.60	0011402637	DUE UPON RECEIPT

BILLING ACCOUNT NAME AND ADDRESS

REMITTANCE ADDRESS

BOARD OF SUPERVISORS
 COUNTY OF RIVERSIDE
 'PO BOX 1147'
 RIVERSIDE, CA 92502

CALIFORNIA NEWSPAPER PARTNERSHIP
 dba The Press-Enterprise
 PO Box 8012
 Willoughby, OH 44096-8012

THE PRESS-ENTERPRISE

1825 Chicago Ave, Suite 100
Riverside, CA 92507
951-684-1200
951-368-9018 FAX

**PROOF OF PUBLICATION
(2010, 2015.5 C.C.P.)**

Publication(s): The Press-Enterprise

PROOF OF PUBLICATION OF

Ad Desc.: NOH - Resolution No. 2020-130 /

I am a citizen of the United States. I am over the age of eighteen years and not a party to or interested in the above entitled matter. I am an authorized representative of THE PRESS-ENTERPRISE, a newspaper in general circulation, printed and published daily in the County of Riverside, and which newspaper has been adjudicated a newspaper of general circulation by the Superior Court of the County of Riverside, State of California, under date of April 25, 1952, Case Number 54446, under date of March 29, 1957, Case Number 65673, under date of August 25, 1995, Case Number 267864, and under date of September 16, 2013, Case Number RIC 1309013; that the notice, of which the annexed is a printed copy, has been published in said newspaper in accordance with the instructions of the person(s) requesting publication, and not in any supplement thereof on the following dates, to wit:

08/06/2020

I certify (or declare) under penalty of perjury that the foregoing is true and correct.

Date: August 06, 2020
At: Riverside, California



Legal Advertising Representative, The Press-Enterprise

BOARD OF SUPERVISORS
COUNTY OF RIVERSIDE
PO BOX 1147
RIVERSIDE, CA 92502

Ad Number: 0011402637-01

P.O. Number:

Ad Copy:

NOTICE OF PUBLIC HEARING BEFORE THE BOARD OF SUPERVISORS OF RIVERSIDE COUNTY

NOTICE IS HEREBY GIVEN that a public hearing at which all interested persons will be heard, will be held before the Board of Supervisors of Riverside County, California, on the 1st Floor Board Chambers, County Administrative Center, 4080 Lemon Street, Riverside, on Tuesday, August 25, 2020, at 9:30 a.m., or as soon as possible thereafter, to consider the following Resolution of the Board of Supervisors of the County of Riverside:

**RESOLUTION NO. 2020-130
RESOLUTION OF THE BOARD OF SUPERVISORS OF THE COUNTY OF RIVERSIDE DECLARING ITS INTENT TO ORDER THE ANNEXATION OF STREET LIGHTING ZONE 138 TO LANDSCAPING AND LIGHTING MAINTENANCE DISTRICT NO. 89-1-CONSOLIDATED OF THE COUNTY OF RIVERSIDE PURSUANT TO THE LANDSCAPING AND LIGHTING ACT OF 1972 FOR THE MAINTENANCE AND SERVICING OF STREETLIGHTS; ADOPTING THE PRELIMINARY ENGINEER'S REPORT; GIVING NOTICE OF AND SETTING THE TIME AND PLACE OF THE PUBLIC HEARING ON THE ANNEXATION OF STREET LIGHTING ZONE 138; ORDERING AN ASSESSMENT BALLOT PROCEEDING CONDUCTED BY MAIL; AND DIRECTING NOTICE OF THE PUBLIC HEARING AND THE ASSESSMENT BALLOT TO BE MAILED PURSUANT TO SAID ACT AND ARTICLE XIID OF THE CALIFORNIA CONSTITUTION AND SECTION 4000 OF THE ELECTIONS CODE**

WHEREAS, the Board of Supervisors (hereinafter the "Board of Supervisors") of the County of Riverside (hereinafter the "County") has adopted Resolution No. 2020-129 on June 30, 2020 initiating proceedings for the annexation of Street Lighting Zone 138 (hereinafter "Street Lighting Zone 138"), as described and shown in Exhibit "A", which is attached hereto and incorporated herein, to Landscaping and Lighting Maintenance District No. 89-1-Consolidated of the County of Riverside, State of California, (hereinafter "L&LMD No. 891C") pursuant to the Landscaping and Lighting Act of 1972 (hereinafter the "Act"), which is Part 2 (commencing with Section 22500) of Division 15 of the Streets and Highways Code (hereinafter the "Streets and Highways Code"), and ordering the preparation of a report (hereinafter the "Report") regarding the proposed annexation of Street Lighting Zone 138 and the assessments to be levied within Street Lighting Zone 138 each fiscal year beginning fiscal year 2021-22 for the maintenance and servicing of streetlights within the public right-of-way within said zone; and

WHEREAS, such proceedings shall comply with the requirements of Article XIID of the California Constitution (hereinafter "Article XIID"), the Act, and Section 4000 of the Elections Code requiring voter approval of the proposed assessment to be levied by L&LMD No. 891C for Street Lighting Zone 138; and

WHEREAS, the Board of Supervisors by Resolution No. 2020-129 directed the Director of the Transportation Department, or her designee (hereinafter the "Engineer"), to prepare and file the Report with the Clerk of the Board of Supervisors in accordance with Sections 22608 and 22585 et. seq. of the Streets and Highways Code and Section 4 of Article XIID; and

WHEREAS, said Engineer has filed the Report with the Clerk of the Board of Supervisors and the Report has been presented to and considered by the Board of Supervisors; and

WHEREAS, the Applicant has executed a "Waiver and Consent Regarding Date of Assessment Ballot Election" allowing for the election to be held on August 25, 2020; and

WHEREAS, it is necessary that the Board of Supervisors adopt a resolution of intention pursuant to Section 22587 of the Streets and Highways Code, which fixes and gives notice, pursuant to Section 22588 of the Streets and Highways Code, of the time and place of a public hearing on said Report, the annexation of Street Lighting Zone 138, and the assessments to be levied on parcels within Street Lighting Zone 138 beginning in fiscal year 2021-22;

NOW, THEREFORE, BE IT RESOLVED, FOUND, DETERMINED AND ORDERED by the Board of Supervisors in regular session assembled on June 30, 2020 as follows:

Section 1. Findings. The Board of Supervisors, after reviewing the Report, finds that:

- (a) The foregoing recitals are true and correct;
- (b) The Report contains all matters required by Sections 22565 through 22574 of the Streets and Highways Code and Section 4 of Article XIID and may, therefore, be approved by the Board of Supervisors;
- (c) The annual assessment for fiscal year 2021-22 on all parcels within Street Lighting Zone 138 will be \$190.00 per acre.

Section 2. Intent. The Board of Supervisors hereby declares its intention to order the annexation of Street Lighting Zone 138, as described and shown in Exhibit "A", to L&LMD No. 89-1-C, and to levy and collect an annual assessment on all assessable lots and parcels of property within Street Lighting Zone 138 commencing with the fiscal year 2021-22 as set forth in the Report. The Report expressly states that there are no parcels or lots within Street Lighting Zone 138 that are owned by a federal, state or other local governmental agency that will benefit from the services to be financed by the annual assessments. The annual assessments will be collected at the same time and in the same manner as property taxes are collected, and all laws providing for the collection and enforcement of property taxes shall apply to the collection and enforcement of said assessments.

Section 3. Boundaries. All the property within the boundaries of Street Lighting Zone 138 is proposed to be annexed to L&LMD No. 89-1-C and shall include that property in the unincorporated area of

County as described and shown in Exhibit "A".

Section 4. Description of Services to be Provided. The services authorized for Street Lighting Zone 138 of L&LMD No. 89-1-C are:

(a) Providing electricity to and the maintenance and servicing of streetlights within the public right-of-way including incidental costs and expenses.

Section 5. Amount to be Levied. The assessment to be levied upon each parcel that benefits from the annexation of Street Lighting Zone 138 to L&LMD No. 891C will be \$190.00 per acre for fiscal year 2021-22. As stated in the Report, the total budget for Street Lighting Zone 138 for the fiscal year 2021-22 is \$1,821.00; there is 1 parcel that is to be assessed that aggregates to 9.59 acres. Each succeeding fiscal year the special assessment may be subject to an annual adjustment that is the greater of two percent (2%) or the cumulative percentage increase, if any, in the Consumer Price Index for all Urban Consumers for electricity ("CPIU-Electricity") for the Riverside-San Bernardino-Ontario California Standard Metropolitan Statistical area ("Index") published by the Bureau of Labor Statistics of the United States Department of Labor. The annual CPIU-Electricity adjustment will be based on the cumulative increase, if any, in the Index as it stands on March of each year over the base Index for March of 2021. Any increase larger than the greater of 2% or the CPIU-Electricity annual adjustment requires a majority approval of all the property owners in Street Lighting Zone 138. The Board of Supervisors will levy the assessment in each subsequent fiscal year until the Board of Supervisors undertakes proceedings for the dissolution of Street Lighting Zone 138 of L&LMD No. 891C. The annual assessment will fund the services described in Section 4 of this Resolution. For further particulars, reference is to be made to the Report on file in the Office of the Clerk of the Board of Supervisors.

Section 6. The Property to be Annexed. The property to be annexed to L&LMD No. 891C is Street Lighting Zone 138. The boundaries of Street Lighting Zone 138 are located within the unincorporated area of the County and are described and shown in the Report and Exhibit "A".

Section 7. Report. The Report, which is on file with the Clerk of the Board of Supervisors and which has been presented to the Board of Supervisors, is hereby approved. Reference is made to the Report for a full and detailed description of the services, the boundaries of Street Lighting Zone 138, and the annual assessment to be levied upon assessable lots and parcels within Street Lighting Zone 138 proposed to be annexed to L&LMD No. 89-1-C.

Section 8. Public Hearing. The question of whether Street Lighting Zone 138 shall be annexed to L&LMD No. 89-1-C and an annual assessment levied beginning with fiscal year 2021-22 shall be considered at a public hearing (hereinafter the "Public Hearing") to be held on August 25, 2020, at 9:30 a.m. at the meeting room of the Board of Supervisors of the County at 4080 Lemon Street, 1st Floor, Riverside, California.

Section 9. Majority Protest. Each owner of record of property within Street Lighting Zone 138 is to receive by mail an assessment ballot that shall conform to the requirements of Section 4 of Article XIID and Section 4000 of the California Elections Code. The assessment ballots are to be returned prior to the Public Hearing. The agency shall not impose an assessment if there is a majority protest. A majority protest exists if, upon the conclusion of the hearing, ballots submitted in opposition to the assessment exceed the ballots submitted in favor of the assessment. In tabulating the ballots, the ballots shall be weighted according to the proportional financial obligation of the affected property.

Section 10. Information. Any property owner desiring additional information regarding Street Lighting Zone 138 of L&LMD No. 891C, the Report, or the proposed assessment is to contact Ms. Brigitte Hahn, Senior Engineering Technician, Transportation Department of the County of Riverside, 4080 Lemon Street, 8th Floor, Riverside, California, 92501, or by telephone at 9519556263, or by email at bhahn@rivco.org.

Section 11. Notice of the Public Hearing. Notice of Public Hearing with regard to the annexation of Street Lighting Zone 138 to L&LMD No. 891C shall be given consistent with Sections 22608 and 22588 of the Streets and Highways Code and Section 4 of Article XIID. The Clerk of the Board of Supervisors shall give notice of the Public Hearing by causing a certified copy of this Resolution to be published once in an appropriate newspaper at least ten (10) days prior to the date of the Public Hearing that is August 25, 2020. Publication of this Resolution is to be effected by the Clerk of the Board of Supervisors. Notice shall also be given by mailing first-class, postage prepaid, those notices, as prepared by County Counsel, assessment ballot and information sheets as required by Section 4 of Article XIID and Section 4000 of the California Elections Code to all owners of record of property within Street Lighting Zone 138 as shown on the last equalized assessment roll of the County. Mailing is to be made by the Engineer and deposited with the U. S. Post Office at least forty-five (45) days prior to the Public Hearing on August 25, 2020.

Section 12. Effective Date. This Resolution shall take effect from and after its date of adoption.

EXHIBIT "A" DESCRIPTION OF BOUNDARIES

The boundaries of Street Lighting Zone 138 to be annexed into Landscaping and Lighting Maintenance District No. 89-1-Consolidated, of the County of Riverside, are coterminous with the boundaries of APN 317-170-046 as shown on Assessment Roll in the County of Riverside, State of California in Fiscal Year 2020-21.

STREET LIGHT ZONE 138
PORTION(S) OF SECTION 12, T.4.S., R.4W.
PLOT PLAN NO. 180023
1 PARCEL

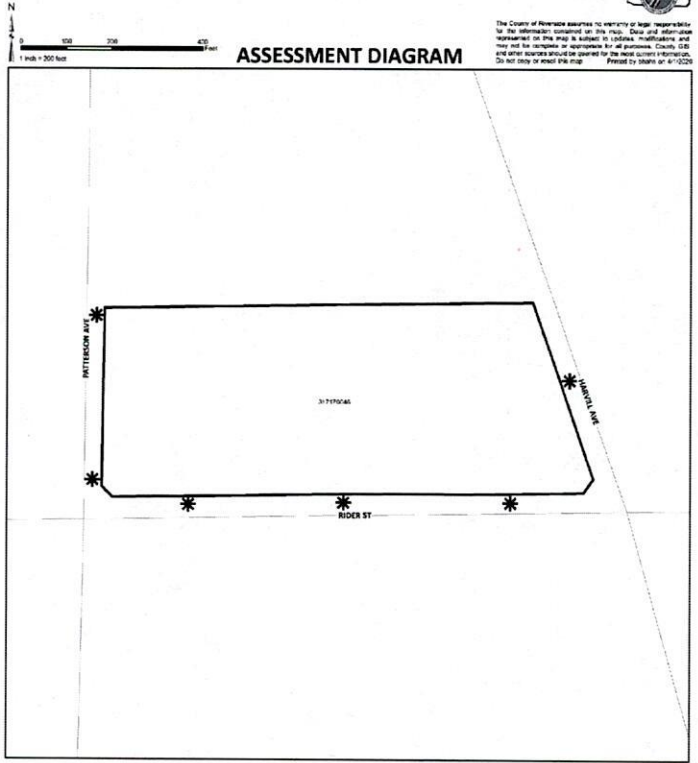

The County of Riverside assumes no liability or legal responsibility for the information contained on this map. Data and information represented on this map is subject to updates, modifications and may not be complete or accurate for all purposes. Check GIS and other sources should be provided for the most current information. Do not rely or expect the map. Printed by SIGMA on 8/1/2020

* DENOTES MAINTAINED ROW STREETLIGHT
□ DENOTES ZONE BOUNDARY

Alternative formats available upon request to individuals with disabilities. If you require reasonable accommodation, please contact Clerk of the Board at (951) 955-1063, at least 72 hours prior to hearing.

Please send all written correspondence to: Clerk of the Board, 4080 Lemon Street, 1st Floor, Post Office Box 1147, Riverside, CA 92502-1147 or email cob@rivco.org

Dated: August 03, 2020 Kecia R. Harper, Clerk of the Board
By: Hannah Lumanauw, Board Assistant
Press-Enterprise: 8/06



OFFICE OF THE
CLERK OF THE BOARD OF SUPERVISORS
1st FLOOR, COUNTY ADMINISTRATIVE CENTER
P.O. BOX 1147, 4080 LEMON STREET
RIVERSIDE, CA 92502-1147
PHONE: (951) 955-1060 FAX: (951) 955-1071

KECIA R. HARPER
Clerk of the Board of Supervisors

KIMBERLY A. RECTOR
Assistant Clerk of the Board

August 03, 2020

PRESS ENTERPRISE
ATTN: LEGALS
P.O. BOX 792
RIVERSIDE, CA 92501

E-MAIL: legals@pe.com
FAX: (951) 368-9018

RE: NOTICE OF PUBLIC HEARING: Resolution No. 2020-130 Resolution of the Board of Supervisors of the County of Riverside

To Whom It May Concern:

Attached is a copy for publication in your newspaper for **ONE (1) TIME on Thursday, August 06, 2020.**

We require your affidavit of publication immediately upon completion of the last publication.

Your invoice must be submitted to this office, **WITH TWO CLIPPINGS OF THE PUBLICATION.**

NOTE: PLEASE COMPOSE THIS PUBLICATION INTO A SINGLE COLUMN FORMAT.

Thank you in advance for your assistance and expertise.

Sincerely,

Hannah Lumanauw

Board Assistant to:
KECIA R. HARPER, CLERK OF THE BOARD

NOTICE OF PUBLIC HEARING BEFORE THE BOARD OF SUPERVISORS OF RIVERSIDE COUNTY

NOTICE IS HEREBY GIVEN that a public hearing at which all interested persons will be heard, will be held before the Board of Supervisors of Riverside County, California, on the 1st Floor Board Chambers, County Administrative Center, 4080 Lemon Street, Riverside, on **Tuesday, August 25, 2020, at 9:30 a.m.**, or as soon as possible thereafter, to consider the following Resolution of the Board of Supervisors of the County of Riverside:

RESOLUTION NO. 2020-130

RESOLUTION OF THE BOARD OF SUPERVISORS OF THE COUNTY OF RIVERSIDE DECLARING ITS INTENT TO ORDER THE ANNEXATION OF STREET LIGHTING ZONE 138 TO LANDSCAPING AND LIGHTING MAINTENANCE DISTRICT NO. 89-1-CONSOLIDATED OF THE COUNTY OF RIVERSIDE PURSUANT TO THE LANDSCAPING AND LIGHTING ACT OF 1972 FOR THE MAINTENANCE AND SERVICING OF STREETLIGHTS; ADOPTING THE PRELIMINARY ENGINEER'S REPORT; GIVING NOTICE OF AND SETTING THE TIME AND PLACE OF THE PUBLIC HEARING ON THE ANNEXATION OF STREET LIGHTING ZONE 138 ; ORDERING AN ASSESSMENT BALLOT PROCEEDING CONDUCTED BY MAIL; AND DIRECTING NOTICE OF THE PUBLIC HEARING AND THE ASSESSMENT BALLOT TO BE MAILED PURSUANT TO SAID ACT AND ARTICLE XIID OF THE CALIFORNIA CONSTITUTION AND SECTION 4000 OF THE ELECTIONS CODE

WHEREAS, the Board of Supervisors (hereinafter the "Board of Supervisors") of the County of Riverside (hereinafter the "County") has adopted Resolution No. 2020-129 on June 30, 2020 initiating proceedings for the annexation of Street Lighting Zone 138 (hereinafter "Street Lighting Zone 138"), as described and shown in Exhibit "A", which is attached hereto and incorporated herein, to Landscaping and Lighting Maintenance District No. 89-1-Consolidated of the County of Riverside, State of California, (hereinafter "L&LMD No. 89-1-C") pursuant to the Landscaping and Lighting Act of 1972 (hereinafter the "Act"), which is Part 2 (commencing with Section 22500) of Division 15 of the Streets and Highways Code (hereinafter the "Streets and Highways Code"), and ordering the preparation of a report (hereinafter the "Report") regarding the proposed annexation of Street Lighting Zone 138 and the assessments to be levied within Street Lighting Zone 138 each fiscal year beginning fiscal year 2021-22 for the maintenance and servicing of streetlights within the public right-of-way within said zone; and

WHEREAS, such proceedings shall comply with the requirements of Article XIID of the California Constitution (hereinafter "Article XIID"), the Act, and Section 4000 of the Elections Code requiring voter approval of the proposed assessment to be levied by L&LMD No. 89-1-C for Street Lighting Zone 138; and

WHEREAS, the Board of Supervisors by Resolution No. 2020-129 directed the Director of the Transportation Department, or her designee (hereinafter the "Engineer"), to prepare and file the Report with the Clerk of the Board of Supervisors in accordance with Sections 22608 and 22585 et. seq. of the Streets and Highways Code and Section 4 of Article XIID; and

WHEREAS, said Engineer has filed the Report with the Clerk of the Board of Supervisors and the Report has been presented to and considered by the Board of Supervisors; and

WHEREAS, the Applicant has executed a "Waiver and Consent Regarding Date of Assessment Ballot Election" allowing for the election to be held on August 25, 2020; and

WHEREAS, it is necessary that the Board of Supervisors adopt a resolution of intention pursuant to Section 22587 of the Streets and Highways Code, which fixes and gives notice, pursuant to Section 22588 of the Streets and Highways Code, of the time and place of a public hearing on said Report, the annexation of Street Lighting Zone 138, and the assessments to be levied on parcels within Street Lighting Zone 138 beginning in fiscal year 2021-22;

NOW, THEREFORE, BE IT RESOLVED, FOUND, DETERMINED AND ORDERED by the Board of Supervisors in regular session assembled on June 30, 2020 as follows:

Section 1. Findings. The Board of Supervisors, after reviewing the Report, finds that:

- (a) The foregoing recitals are true and correct;
- (b) The Report contains all matters required by Sections 22565 through 22574 of the Streets and Highways Code and Section 4 of Article XIID and may, therefore, be approved by the Board of Supervisors;
- (c) The annual assessment for fiscal year 2021-22 on all parcels within Street Lighting Zone 138 will be \$190.00 per acre.

Section 2. Intent. The Board of Supervisors hereby declares its intention to order the annexation of Street Lighting Zone 138, as described and shown in Exhibit "A", to L&LMD No. 89-1-C, and to levy and collect an annual assessment on all assessable lots and parcels of property within Street Lighting Zone 138 commencing with the fiscal year 2021-22 as set forth in the Report. The Report expressly states that there are no parcels or lots within Street Lighting Zone 138 that are owned by a federal, state or other local governmental agency that will benefit from the services to be financed by the annual assessments. The annual assessments will be collected at the same time and in the same manner as property taxes are collected, and all laws providing for the collection and enforcement of property taxes shall apply to the collection and enforcement of said assessments.

Section 3. Boundaries. All the property within the boundaries of Street Lighting Zone 138 is proposed to be annexed to L&LMD No. 89-1-C and shall include that property in the unincorporated area of the County as described and shown in Exhibit "A".

Section 4. Description of Services to be Provided. The services authorized for Street Lighting Zone 138 of L&LMD No. 89-1-C are:

- (a) Providing electricity to and the maintenance and servicing of streetlights within the public right-of-way including incidental costs and expenses.

Section 5. Amount to be Levied. The assessment to be levied upon each parcel that benefits from the annexation of Street Lighting Zone 138 to L&LMD No. 89-1-C will be \$190.00 per acre for fiscal year 2021-22. As stated in the Report, the total budget for Street Lighting Zone 138 for the fiscal year 2021-22 is \$1,821.00; there is 1 parcel that is to be assessed that aggregates to 9.59 acres. Each succeeding fiscal year the special assessment may be subject to an annual adjustment that is the greater of two percent (2%) or the cumulative percentage increase, if any, in the Consumer Price Index for all Urban Consumers for electricity ("CPI-U-Electricity") for the Riverside-San Bernardino-Ontario California Standard Metropolitan Statistical area ("Index") published by the Bureau of Labor Statistics of the United States Department of Labor. The annual CPI-U-Electricity adjustment will be based on the cumulative increase, if any, in the Index as it stands on March of each year over the base Index for March of 2021. Any increase larger than the greater of 2% or the CPI-U-Electricity annual adjustment requires a majority approval of all the property owners in Street Lighting Zone 138. The Board of Supervisors will levy the assessment in each subsequent fiscal year until the Board of Supervisors undertakes proceedings for the dissolution of Street Lighting Zone 138 of L&LMD No. 89-1-C. The annual assessment will fund the services described in Section 4 of this Resolution. For further particulars, reference is to be made to the Report on file in the Office of the Clerk of the Board of Supervisors.

Section 6. The Property to be Annexed. The property to be annexed to L&LMD No. 89-1-C is Street Lighting Zone 138. The boundaries of Street Lighting Zone 138 are located within the unincorporated area of the County and are described and shown in the Report and Exhibit "A".

Section 7. Report. The Report, which is on file with the Clerk of the Board of Supervisors and which has been presented to the Board of Supervisors, is hereby approved. Reference is made to the Report for a full and detailed description of the services, the boundaries of Street Lighting Zone 138, and the annual

assessment to be levied upon assessable lots and parcels within Street Lighting Zone 138 proposed to be annexed to L&LMD No. 89-1-C.

Section 8. Public Hearing. The question of whether Street Lighting Zone 138 shall be annexed to L&LMD No. 89-1-C and an annual assessment levied beginning with fiscal year 2021-22 shall be considered at a public hearing (hereinafter the "Public Hearing") to be held on August 25, 2020, at 9:30 a.m. at the meeting room of the Board of Supervisors of the County at 4080 Lemon Street, 1st Floor, Riverside, California.

Section 9. Majority Protest. Each owner of record of property within Street Lighting Zone 138 is to receive by mail an assessment ballot that shall conform to the requirements of Section 4 of Article XIID and Section 4000 of the California Elections Code. The assessment ballots are to be returned prior to the Public Hearing. The agency shall not impose an assessment if there is a majority protest. A majority protest exists if, upon the conclusion of the hearing, ballots submitted in opposition to the assessment exceed the ballots submitted in favor of the assessment. In tabulating the ballots, the ballots shall be weighted according to the proportional financial obligation of the affected property.

Section 10. Information. Any property owner desiring additional information regarding Street Lighting Zone 138 of L&LMD No. 89-1-C, the Report, or the proposed assessment is to contact Ms. Brigitte Hahn, Senior Engineering Technician, Transportation Department of the County of Riverside, 4080 Lemon Street, 8th Floor, Riverside, California, 92501, or by telephone at 951-955-6263, or by e-mail at bhahn@rivco.org.

Section 11. Notice of the Public Hearing. Notice of Public Hearing with regard to the annexation of Street Lighting Zone 138 to L&LMD No. 89-1-C shall be given consistent with Sections 22608 and 22588 of the Streets and Highways Code and Section 4 of Article XIID. The Clerk of the Board of Supervisors shall give notice of the Public Hearing by causing a certified copy of this Resolution to be published once in an appropriate newspaper at least ten (10) days prior to the date of the Public Hearing that is August 25, 2020. Publication of this Resolution is to be effected by the Clerk of the Board of Supervisors. Notice shall also be given by mailing first-class, postage prepaid, those notices, as prepared by County Counsel, assessment ballot and information sheets as required by Section 4 of Article XIID and Section 4000 of the California Elections Code to all owners of record of property within Street Lighting Zone 138 as shown on the last equalized assessment roll of the County. Mailing is to be made by the Engineer and deposited with the U. S. Post Office at least forty-five (45) days prior to the Public Hearing on August 25, 2020.

Section 12 Effective Date. This Resolution shall take effect from and after its date of adoption.

(Insert Exhibit "A")

Alternative formats available upon request to individuals with disabilities. If you require reasonable accommodation, please contact Clerk of the Board at (951) 955-1063, at least 72 hours prior to hearing.

Please send all written correspondence to: Clerk of the Board, 4080 Lemon Street, 1st Floor, Post Office Box 1147, Riverside, CA 92502-1147 or email cob@rivco.org

Dated: August 03, 2020

Kecia R. Harper, Clerk of the Board
By: Hannah Lumanauw, Board Assistant

EXHIBIT "A"

DESCRIPTION OF BOUNDARIES

The boundaries of Street Lighting Zone 138 to be annexed into Landscaping and Lighting Maintenance District No. 89-1-Consolidated, of the County of Riverside, are coterminous with the boundaries of APN 317-170-046 as shown on Assessment Roll in the County of Riverside, State of California in Fiscal Year 2020-21.

1
2
3
4
5
6
7
8
9
10
11
12
13
14
15
16
17
18
19
20
21
22
23
24

LANDSCAPING AND LIGHTING MAINTENANCE DISTRICT NO. 89-1 CONSOLIDATED

STREET LIGHT ZONE 138
PORTION(S) OF SECTION 12, T.4.S., R.4W.
PLOT PLAN NO. 180023
1 PARCEL

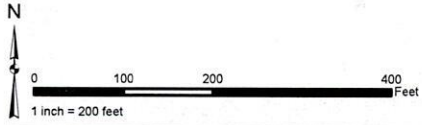

The County of Riverside assumes no warranty or legal responsibility for the information contained on this map. Data and information represented on this map is subject to updates, modifications and may not be complete or appropriate for all purposes. County GIS and other sources should be queried for the most current information. Do not copy or resell this map. Printed by bhahn on 4/1/2020

ASSESSMENT DIAGRAM

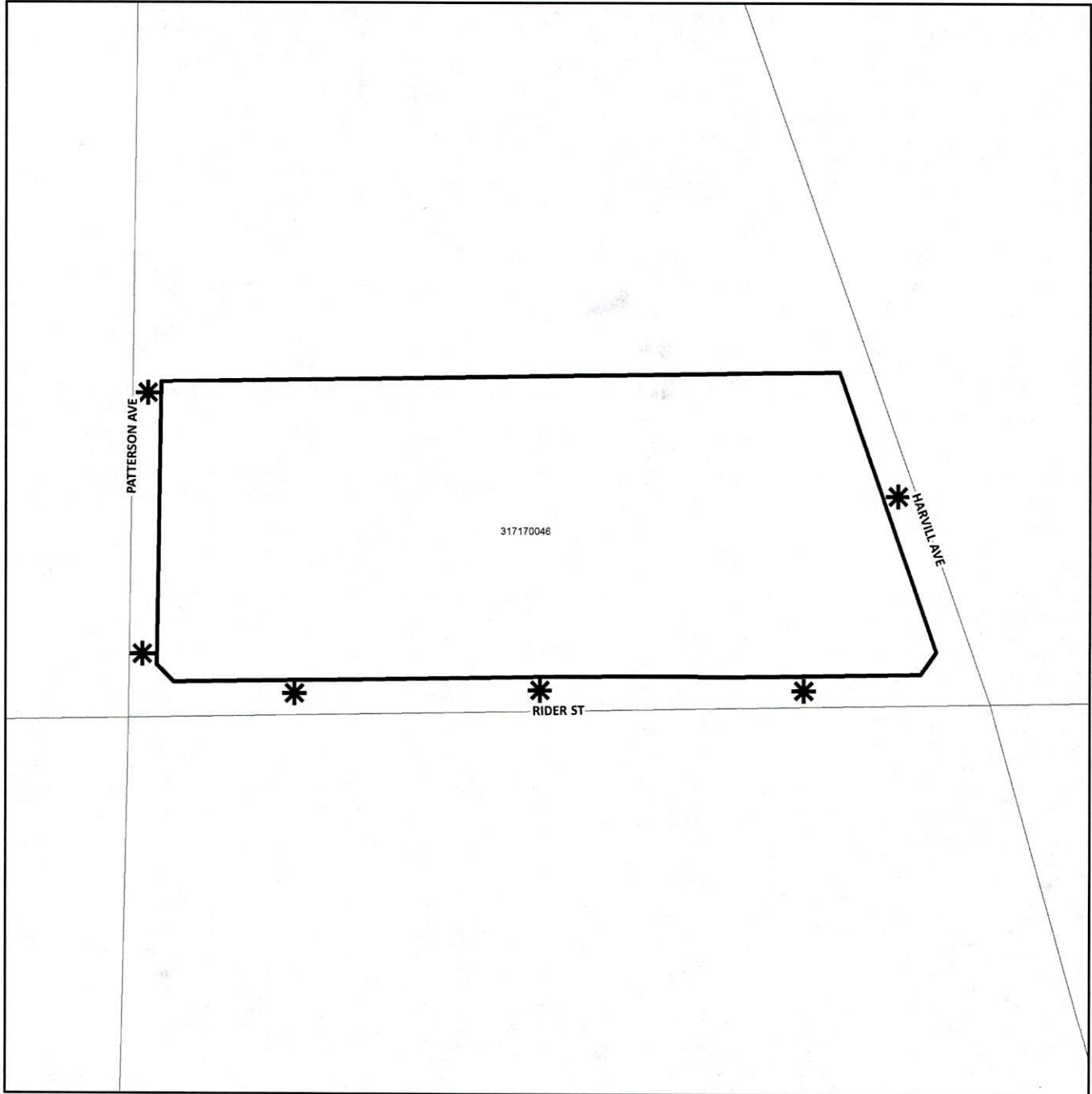

- * DENOTES MAINTAINED ROW STREETLIGHT
- DENOTES ZONE BOUNDARY