

**SUBMITTAL TO THE BOARD OF SUPERVISORS  
COUNTY OF RIVERSIDE, STATE OF CALIFORNIA**



**ITEM: 3.15  
(ID # 29698)**

**MEETING DATE:**  
Tuesday, February 03, 2026

**FROM :** TLMA-TRANSPORTATION

**SUBJECT:** TRANSPORTATION AND LAND MANAGEMENT AGENCY/TRANSPORTATION:  
Approve Addenda to the Plans and Specifications, Accept the Low Bid and Award the Contract for the Construction of the Cajalco Road and Carroll Street Traffic Signal and Safety Lighting Project, in the Community of Mead Valley. District 1. [\$341,649 Total Cost - Local Funds 100% / \$5,500 Ongoing Cost - Gas Tax 100%] (4/5 Vote Required)

**RECOMMENDED MOTION:** That the Board of Supervisors:

1. Approve three addenda to the plans and specifications issued prior to the November 26, 2025, bid opening;
2. Waive any and all immaterial irregularities and accept the low bid of California Professional Engineering Inc. of La Puente, California in the amount of \$341,649.18;
3. Award the Contract to California Professional Engineering Inc. and authorize the Chair of the Board to execute the contract documents;
4. Direct the Purchasing Agent to issue Purchase Orders to California Professional Engineering Inc. for the total amount of \$341,649.18; and
5. Approve the project's proposed budget as shown in Attachment "A".

**ACTION:4/5 Vote Required, Policy**

  
Dennis Acuna, Director of Transportation 1/15/2026

---

**MINUTES OF THE BOARD OF SUPERVISORS**

On motion of Supervisor Washington, seconded by Supervisor Gutierrez and duly carried by unanimous vote, IT WAS ORDERED that the above matter is approved as recommended.

Ayes: Medina, Spiegel, Washington, Perez, and Gutierrez  
Nays: None  
Absent: None  
Date: February 3, 2026  
xc: Transp.

Kimberly A. Rector  
Clerk of the Board  
By:   
Deputy

**SUBMITTAL TO THE BOARD OF SUPERVISORS COUNTY OF RIVERSIDE,  
STATE OF CALIFORNIA**

<b>FINANCIAL DATA</b>	<b>Current Fiscal Year:</b>	<b>Next Fiscal Year:</b>	<b>Total Cost:</b>	<b>Ongoing Cost</b>
<b>COST</b>	\$ 241,649	\$ 100,000	\$ 341,649	\$ 5,500
<b>NET COUNTY COST</b>	\$ 0	\$ 0	\$ 0	\$ 0
<b>SOURCE OF FUNDS:</b> Total Cost - Combined Improvement Fund (50%), Developer Contributions (50%) / Ongoing Cost – Gas Tax (100%) There are no General Funds used in this project.			<b>Budget Adjustment: No</b>	
			<b>For Fiscal Year: 25/26-26/27</b>	

**C.E.O. RECOMMENDATION:** Approve

**BACKGROUND:**

**Summary**

By Minute Order dated October 21, 2025 (Agenda Item 3.38), the County of Riverside Board of Supervisors authorized the Clerk of the Board to advertise for the construction of the Cajalco Road and Carroll Street Traffic Signal and Safety Lighting Project, in the Community of Mead Valley.

On December 3, 2024 (Agenda Item 3.82), the County of Riverside Board of Supervisors approved the Cooperative Agreement between the County of Riverside (County) and Deemarco Limited Partnership (Developer) for the Cajalco Road and Carroll Street Traffic Signal Project (Project) in the Community of Mead Valley. The Agreement established the terms of the parties' responsibilities and cost sharing. The County is designated as the lead agency for the construction of the Project.

At this "T" intersection, Carroll Street is a two-lane local road that extends southerly from Cajalco Road. Cajalco Road is a two-lane road that travels in the east-west direction with a left-turn lane for westbound vehicles turning south onto Carroll Street. Carroll Street is currently controlled by a stop sign while the vehicles on Cajalco Road continue driving without having to stop. The area in the immediate vicinity includes vacant land on the north half and south-east quadrant of the intersection and recently developed commercial land on the south-west quadrant of the intersection.

Project construction will include installation of traffic signal poles with mast-arms, safety lighting, traffic signal cabinets, video and radar detection units, installation of new thermoplastic and paint traffic striping and pavement markings, roadside signs, and other associated work.

During the advertisement period, three addenda were issued to all registered plan holders as a supplement to the plans and specifications. Bidders were required to acknowledge and take into account the addenda issued on their contractor's Bid in order to be considered for award.

**SUBMITTAL TO THE BOARD OF SUPERVISORS COUNTY OF RIVERSIDE,  
STATE OF CALIFORNIA**

The addenda were issued to clarify and modify the approved contract documents. Addenda No. 1 and No. 3 increased costs; thus a 4/5ths vote is required. The addenda are attached and designated as Addendum No. 1 through Addendum No. 3.

The Contract includes the following schedule of work:

Base Bid: Cajalco Road and Carroll Street Traffic Signal and Safety Lighting Project

The contractor, California Professional Engineering Inc., is qualified to perform the work as outlined in the bid, has executed the Contract, and has provided bonds and insurance documents which meet the requirements of the contract documents.

Project No.: D3-0115

**Impact on Citizens and Businesses**

The traffic signal will improve traffic safety by providing controlled traffic movements at the Cajalco Road and Carroll Street "T" intersection.

The work is scheduled to begin in spring 2026. The work will be phased to keep the road open during construction as much as possible and will take approximately two months to complete.

**SUPPLEMENTAL:**

**Additional Fiscal Information**

Construction is expected to be completed in Fiscal Year 2026/2027 and will be funded with Combined Improvement Fund and Developer Contributions Fund.

Annual traffic signal operation and maintenance costs are estimated at \$5,500 to be funded by County from gas tax.

The proposed budget as shown on Attachment "A" includes Contract award amount and other associated costs.

There are no General Funds used in this project.

**Contract History and Price Reasonableness**

A total of five bids were received on Wednesday November 26, 2025, ranging from \$341,649 to \$475,715. The basis for the selection of a contractor is the lowest responsive and responsible bid. The low bidder, California Professional Engineering Inc., submitted the lowest responsive and responsible bid in the amount of \$341,649 which is \$16,015 (4.9%) above the engineer's cost estimate.

The Transportation Department recommends the award of the Contract to California Professional Engineering Inc. in the amount of \$341,649.

SUBMITTAL TO THE BOARD OF SUPERVISORS COUNTY OF RIVERSIDE,  
STATE OF CALIFORNIA

**ATTACHMENTS:**

Vicinity Map  
Attachment "A"  
Summary of Bids  
Addendum No. 1, No. 2, and No. 3  
Contract/Bonds/Insurance  
Contractor's Bid Proposal

*Melissa Curtis*  
Melissa Curtis, Deputy Director of Purchasing and Fleet 1/15/2026

*Crystal Carrillo*  
Crystal Carrillo, Senior Management Analyst 1/28/2026

*Aaron Gettis*  
Aaron Gettis, Chief Deputy County Counsel 1/22/2026

## Contract

THIS CONTRACT is entered into at Riverside, California as of the date set forth below is between County of Riverside hereafter called "County" and **California Professional Engineering, Inc.**, hereafter called "Contractor".

### W I T N E S S E T H

#### **Recitals:**

1. Contractor has submitted to County his Contractor's Proposal for the construction of County Project, **Cajalco Road and Carroll Street, Traffic Signal and Safety Lighting Project, Community of Mead Valley, Project No. D3-0115**, in strict accordance with the Contract Documents identified below and County has accepted said Proposal.
2. Contractor states that he has reexamined his Contractor's Proposal and found it to be correct, has ascertained that his subcontractors are properly licensed and possess the requisite skill and forces, has reexamined the site and Contract Documents and is of the opinion that he can presently do the work in accordance with the Contract Documents for the money set forth in his Proposal to be paid as provided in the Contract Documents.

#### **Agreement:**

It is agreed by the parties as follows:

##### 1. Contract Documents

The entire Contract consists of the following: (a) The Construction Contract, (b) The Notice to Bidders, (c) The Instruction to Bidders, (d) The Bid, (e) The Bid Bond, (f) The Payment Bond, (g) The Performance Bond, (h) The General Conditions, (i) The Special Provisions, (j) The Standard Specifications of the State of California Department of Transportation edition of **2018** as modified in other portions of the Contract Documents and as amended by the State of California Department of Transportation, (k) The Standard Plans of the Department of Transportation identified on the plans or in the Special Provisions, (l) The Plans, (m) Addenda **(Three)**, (n) The Determination of Prevailing Wage Rates for Public Works, (o) Any Change Orders issued, and (p) Any additional or supplemental specifications, notice, instructions and drawings issued in accordance with the provisions of the Contract Documents. All of said Documents presently in existence are by this reference incorporated herein with like effect as if here set forth in full and upon the proper issuance of other documents they shall likewise be deemed incorporated. The Bid Bond is exonerated upon execution of this Contract and the Payment Bond and Performance Bond.

## 2. The Work

Contractor shall do all tasks necessary to construct the work generally described in Recital No. 1 in accordance with the Contract Documents.

## 3. Prosecution, Progress and Liquidated Damages

Attention is directed to the provisions in Section 8-1.04, "Start of Job Site Activities", Section 8-1.05, "Time", and in Section 8-1.10 "Liquidated Damages" of the Standard Specifications and these Special Provisions.

Standard Specification Section 8-1.04B, "Standard Start" is modified to read as follows:

The Contractor shall begin work within fifteen (15) calendar days, or as revised in the Special Provisions, of the date stated within the written "Notice to Proceed".

The Contractor shall notify the Engineer, in writing, of the Contractor's intent to begin work at least 72 hours before work is begun. If the project has more than one (1) location of work, Contractor shall submit a separate notice for each location. The notice shall be delivered to the Transportation Department's Construction Engineer and shall specify the date the Contractor intends to start at said location.

Should the Contractor begin work in advance of receiving a written "Notice to Proceed", any work performed by the Contractor in advance of the date stated in the "Notice to Proceed" shall be considered as having been done by the Contractor at his own risk and as a volunteer and subject to the following:

- A. The Contractor shall, on commencing operations, take all precautions required for public safety and shall observe all the provisions in the Specifications and the Special Provisions.
- B. All work done according to the Contract, prior to the issuance of the "Notice to Proceed", will be considered authorized work and will be paid for as provided in the contract.
- C. The Contractor shall not be entitled to any additional compensation or an extension of time for any delay, hindrance or interference caused by or attributable to commencement of work prior to the issuance of the "Notice to Proceed".

## 4. Compensation

Contractor shall be paid in the manner set forth in the Contract Documents the amount of his Proposal as accepted by County, the above rates, subject to additions and deductions as provided in the Contract Documents. Said Proposal is on file in the Office of the Clerk of the Board of Supervisors of County.

**Cajalco Road and Carroll Street  
Traffic Signal and Safety Lighting Project  
Community of Mead Valley  
Project No. D3-0115**

**Contract**

ITEM No.	ITEM CODE	ITEM	UNIT	ESTIMATED QUANTITY	ITEM PRICE (IN FIGURES)	TOTAL (IN FIGURES)
<b>BASE BID - Cajalco Road and Carroll Street Traffic Signal and Safety Lighting Project</b>						
1	066100	DUST ABATEMENT	LS	1	1,500.00	1,500.00
2	100100	DEVELOP WATER SUPPLY	LS	1	2,000.00	2,000.00
3	120100	TRAFFIC CONTROL SYSTEM	LS	1	30,399.00	30,399.00
4	130200	PREPARE WATER POLLUTION CONTROL PROGRAM	LS	1	2,500.00	2,500.00
5	015602	FUNDING AWARENESS SIGN	EA	1	3,000.00	3,000.00
6	820410	SALVAGE ROADSIDE SIGN	EA	1	174.00	174.00
7	820840	ROADSIDE SIGN - ONE POST	EA	6	609.00	3,654.00
8	840515	THERMOPLASTIC PAVEMENT MARKING	SQFT	54	7.25	391.50
9	846035	REMOVE THERMOPLASTIC PAVEMENT MARKING	SQFT	44	5.22	229.68
10	870400	SIGNAL AND LIGHTING SYSTEM	LS	1	244,700.00	244,700.00
11	010602	MISCELLANEOUS WORK (AS DIRECTED)	FA	1	25,000.00	25,000.00
12	730010	MINOR CONCRETE (CURB) [TYPE "D" 8" CURB (CRS 204)]	LF	30	232.00	6,960.00
13	730070	DETECTABLE WARNING SURFACE	SQFT	63	87.00	5,481.00
14	731521	MINOR CONCRETE (SIDEWALK)	CY	6	1,972.00	11,832.00
15	731850	REMOVE CONCRETE (CURB RAMP)	CY	3	1,276.00	3,828.00

**PROJECT  
TOTAL:  
ITEMS 1 – 15**

**Three hundred forty-one thousand, six hundred forty-nine dollars  
and eighteen cents**

**\$341,649.18**

“WORDS”

**Cajalco Road and Carroll Street  
Traffic Signal and Safety Lighting Project  
Community of Mead Valley  
Project No. D3-0115**

IN WITNESS WHEREOF the parties hereto have executed this Contract as of the date set forth below.

COUNTY OF RIVERSIDE

CALIFORNIA PROFESSIONAL ENGINEERING, INC.

BY: Karen S. Spiegel  
**KAREN SPIEGEL**  
Chair, Board of Supervisors

BY: [Signature]

DATED: FEB 03 2026

TITLE: President  
(If Corporation, affix Seal)

ATTEST:

ATTEST:

Kimberly A. Rector, Clerk of the Board

[Signature]

BY: [Signature]  
Deputy

TITLE: Field Manager

Licensed in accordance with an act providing for the registration of Contractors,

FORM APPROVED COUNTY COUNSEL  
BY: [Signature]  
DANIELLE D. MALAND

License No.: 793907

Federal Employer Identification Number:

95-4837794

Department of Industrial Relations Registration Number:

1000377609

BY \_\_\_\_\_  
"County"

\_\_\_\_\_  
"Corporation"  
(Seal)

# CALIFORNIA ALL- PURPOSE CERTIFICATE OF ACKNOWLEDGMENT

A notary public or other officer completing this certificate verifies only the identity of the individual who signed the document to which this certificate is attached, and not the truthfulness, accuracy, or validity of that document.

State of California }

County of Los Angeles }

On December 17, 2025 before me, Tracy Sooc, Notary Public,  
(Here insert name and title of the officer)

personally appeared Van Nguyen,  
who proved to me on the basis of satisfactory evidence to be the person(s) whose name(s) is/are subscribed to the within instrument and acknowledged to me that he/she/they executed the same in his/her/their authorized capacity(ies), and that by his/her/their signature(s) on the instrument the person(s), or the entity upon behalf of which the person(s) acted, executed the instrument.

I certify under PENALTY OF PERJURY under the laws of the State of California that the foregoing paragraph is true and correct.

WITNESS my hand and official seal.

\_\_\_\_\_  
Notary Public Signature

(Notary Public Seal)



## ADDITIONAL OPTIONAL INFORMATION

**DESCRIPTION OF THE ATTACHED DOCUMENT**

Contract  
(Title or description of attached document)

\_\_\_\_\_  
(Title or description of attached document continued)

Number of Pages \_\_\_\_\_ Document Date \_\_\_\_\_

### CAPACITY CLAIMED BY THE SIGNER

- Individual (s)  
 Corporate Officer

\_\_\_\_\_  
(Title)

- Partner(s)  
 Attorney-in-Fact  
 Trustee(s)  
 Other \_\_\_\_\_

## INSTRUCTIONS FOR COMPLETING THIS FORM

*This form complies with current California statutes regarding notary wording and, if needed, should be completed and attached to the document. Acknowledgments from other states may be completed for documents being sent to that state so long as the wording does not require the California notary to violate California notary law.*

- State and County information must be the State and County where the document signer(s) personally appeared before the notary public for acknowledgment.
- Date of notarization must be the date that the signer(s) personally appeared which must also be the same date the acknowledgment is completed.
- The notary public must print his or her name as it appears within his or her commission followed by a comma and then your title (notary public).
- Print the name(s) of document signer(s) who personally appear at the time of notarization.
- Indicate the correct singular or plural forms by crossing off incorrect forms (i.e. ~~he/she/they~~, is /are ) or circling the correct forms. Failure to correctly indicate this information may lead to rejection of document recording.
- The notary seal impression must be clear and photographically reproducible. Impression must not cover text or lines. If seal impression smudges, re-seal if a sufficient area permits, otherwise complete a different acknowledgment form.
- Signature of the notary public must match the signature on file with the office of the county clerk.
  - ❖ Additional information is not required but could help to ensure this acknowledgment is not misused or attached to a different document.
  - ❖ Indicate title or type of attached document, number of pages and date.
  - ❖ Indicate the capacity claimed by the signer. If the claimed capacity is a corporate officer, indicate the title (i.e. CEO, CFO, Secretary).
- Securely attach this document to the signed document with a staple.

MINUTES OF THE ANNUAL MEETING OF SHAREHOLDERS AND DIRECTORS  
CALIFORNIA PROFESSIONAL ENGINEERING, INC.

The annual meeting of the shareholders of the above-named California Corporation was duly held at the principal office of the corporation located at 19062 San Jose Avenue, La Puente, CA 91748, USA on January 3, 2025.

The Director present was **VAN TAN NGUYEN**.

President acting as Chairman, same being **VAN TAN NGUYEN**.

The Chairman then presented and read to the meeting a Waiver of Notice of Meeting, subscribed by all of the Directors of the Corporation. Upon motion duly made, it was:

Resolved, that the Chairman be requested to cause the same to be spread at length upon the minutes.

Resolved, that the following persons were nominated and thereupon elected to the position opposite their names to serve until their successors are elected and qualified:

**VAN NGUYEN, PRESIDENT**  
**VAN NGUYEN, SECRETARY**  
**PHUONG-THAO NGUYEN, CHIEF FINANCIAL OFFICER (CFO)**

Resolved, that the above persons elected may sign all binding, contractual documents on behalf of the Corporation.

The President, Secretary, and Treasurer thereupon assumed their respective offices.

The President then presented and read the minutes of the annual meeting of shareholders of this Corporation, and the same were, on motion duly made, seconded and unanimously carried, in all aspects ratified and adopted by this Board of Directors.

There being no further business to come before the meeting, upon motion duly made, seconded and unanimously carried, the same was adjourned.

The foregoing minutes of January 3, 2025 are approved:

  
\_\_\_\_\_  
VAN NGUYEN, President

  
\_\_\_\_\_  
VAN NGUYEN, Secretary



**Performance Bond**

**Recitals:**

- 1. **California Professional Engineering, Inc.** (Contractor) has entered into a Contract with COUNTY OF RIVERSIDE (County) for construction of public work known as **Cajalco Road and Carroll Street, Traffic Signal and Safety Lighting Project, Community of Mead Valley, Project No. D3-0115.**
- 2. \_\_\_\_\_, a \_\_\_\_\_ corporation (Surety), is the Surety under this Bond.

**Agreement:**

We, Contractor as Principal and Surety as Surety, jointly and severally agree, state, and are bound unto County, as obligee, as follows:

- 1. The amount of the obligation of this Bond is 100% of the estimated contract price for the Project of **\$341,649.18 (Three hundred forty-one thousand, six hundred forty-nine dollars and eighteen cents)** and inures to the benefit of County.
- 2. This Bond is exonerated by Contractor doing all things to be kept and performed by it in strict conformance with the Contract Documents for this project, otherwise it remains in full force and effect for the recovery of loss, damage and expense of County resulting from failure of Contractor to so act. All of said Contract Documents are incorporated herein.
- 3. This obligation is binding on our successors and assigns.
- 4. For value received, Surety stipulates and agrees that no change, time extension, prepayment to Contractor, alteration or addition to the terms and requirements of the Contract Documents or the work to be performed thereunder shall affect its obligations hereunder and waives notice as to such matters, except the total contract price cannot be increased by more than 10% without approval of Surety.

THIS BOND is executed as of \_\_\_\_\_.

By \_\_\_\_\_

By \_\_\_\_\_

By \_\_\_\_\_

Type Name \_\_\_\_\_

Its Attorney in Fact  
"Surety"

Title \_\_\_\_\_

"Contractor"

(Corporate Seal)

(Corporate Seal)

**NOTE: This Bond must be executed by both parties with corporate seal affixed. All signatures must be acknowledged.** (Attach acknowledgements).

**Payment Bond**

(Public Works - Civil Code §9550 et seq.)

The makers of this Bond are **California Professional Engineering, Inc.** as Principal and Original Contractor and \_\_\_\_\_, a corporation, authorized to issue Surety Bonds in California, as Surety, and this Bond is issued in conjunction with that certain public works contract to be executed between Principal and COUNTY OF RIVERSIDE a public entity, as Owner, for **\$341,649.18 (Three hundred forty-one thousand, six hundred forty-nine dollars and eighteen cents)** the total amount payable. The amount of this bond is one hundred percent (100%) of said sum. Said contract is for public work generally consisting of **Cajalco Road and Carroll Street, Traffic Signal and Safety Lighting Project, Community of Mead Valley, Project No. D3-0115.**

The beneficiaries of this Bond are as is stated in 9554 of the Civil Code and requirements and conditions of this Bond are as is set forth in 9554, 9558, 9560 and 9564 of said code. Without notice, Surety consents to extension of time for performance, change in requirements, amount of compensation, or prepayment under said contract.

Dated: \_\_\_\_\_ Original Contractor – Principal

\_\_\_\_\_ By \_\_\_\_\_  
Surety

By \_\_\_\_\_ Title \_\_\_\_\_  
Its Attorney In Fact (If corporation, affix seal)

(Corporate Seal)

(Corporate Seal)

STATE OF \_\_\_\_\_ }  
COUNTY OF \_\_\_\_\_ } ss. SURETY'S ACKNOWLEDGEMENT

On \_\_\_\_\_ before me, \_\_\_\_\_ personally appeared, \_\_\_\_\_, known to me, or proved to me on the basis of satisfactory evidence, to be the person whose name is subscribed to the within instrument and acknowledged to me that he executed the same in his authorized capacities, and that by his signature on the instrument the person, or the entity upon behalf of which the person acted, executed the instrument.

WITNESS my hand and official seal.

\_\_\_\_\_  
Signature of Notary Public

Notary Public (Seal)

**NOTE: This Bond must be executed by both parties with corporate seal affixed. All signatures must be acknowledged. (Attach acknowledgements).**

### Performance Bond

**Recitals:**

1. **California Professional Engineering, Inc.** (Contractor) has entered into a Contract with COUNTY OF RIVERSIDE (County) for construction of public work known as **Cajalco Road and Carroll Street, Traffic Signal and Safety Lighting Project, Community of Mead Valley, Project No. D3-0115.**
2. Endurance Assurance Corporation, a Delaware corporation (Surety), is the Surety under this Bond.

**Agreement:**

We, Contractor as Principal and Surety as Surety, jointly and severally agree, state, and are bound unto County, as obligee, as follows:

1. The amount of the obligation of this Bond is 100% of the estimated contract price for the Project of **\$341,649.18 (Three hundred forty-one thousand, six hundred forty-nine dollars and eighteen cents)** and inures to the benefit of County.
2. This Bond is exonerated by Contractor doing all things to be kept and performed by it in strict conformance with the Contract Documents for this project, otherwise it remains in full force and effect for the recovery of loss, damage and expense of County resulting from failure of Contractor to so act. All of said Contract Documents are incorporated herein.
3. This obligation is binding on our successors and assigns.
4. For value received, Surety stipulates and agrees that no change, time extension, prepayment to Contractor, alteration or addition to the terms and requirements of the Contract Documents or the work to be performed thereunder shall affect its obligations hereunder and waives notice as to such matters, except the total contract price cannot be increased by more than 10% without approval of Surety.

THIS BOND is executed as of December 17, 2025.

By California Professional Engineering, Inc.

By 

Title Van Nguyen, President

"Contractor"

(Corporate Seal)

Endurance Assurance Corporation

By 

Type Name Christine Woolford

Its Attorney in Fact  
"Surety"

(Corporate Seal)

**NOTE: This Bond must be executed by both parties with corporate seal affixed. All signatures must be acknowledged. (Attach acknowledgements).**

# CALIFORNIA ALL- PURPOSE CERTIFICATE OF ACKNOWLEDGMENT

A notary public or other officer completing this certificate verifies only the identity of the individual who signed the document to which this certificate is attached, and not the truthfulness, accuracy, or validity of that document.

State of California }

County of Los Angeles }

On December 18, 2025 before me, Diem Chu, Notary Public,  
(Here insert name and title of the officer)

personally appeared Van Nguyen,  
who proved to me on the basis of satisfactory evidence to be the person(s) whose name(s) is/are subscribed to the within instrument and acknowledged to me that he/she/they executed the same in his/her/their authorized capacity(ies), and that by his/her/their signature(s) on the instrument the person(s), or the entity upon behalf of which the person(s) acted, executed the instrument.

I certify under PENALTY OF PERJURY under the laws of the State of California that the foregoing paragraph is true and correct.

WITNESS my hand and official seal.



Notary Public Signature

(Notary Public Seal)

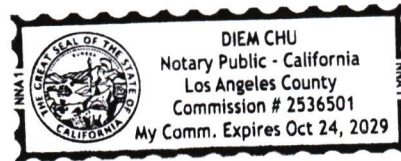

## ADDITIONAL OPTIONAL INFORMATION

### DESCRIPTION OF THE ATTACHED DOCUMENT

(Title or description of attached document)

(Title or description of attached document continued)

Number of Pages \_\_\_\_\_ Document Date \_\_\_\_\_

### CAPACITY CLAIMED BY THE SIGNER

- Individual (s)
- Corporate Officer  
President, Secretary  
(Title)
- Partner(s)
- Attorney-in-Fact
- Trustee(s)
- Other \_\_\_\_\_

## INSTRUCTIONS FOR COMPLETING THIS FORM

*This form complies with current California statutes regarding notary wording and, if needed, should be completed and attached to the document. Acknowledgments from other states may be completed for documents being sent to that state so long as the wording does not require the California notary to violate California notary law.*

- State and County information must be the State and County where the document signer(s) personally appeared before the notary public for acknowledgment.
- Date of notarization must be the date that the signer(s) personally appeared which must also be the same date the acknowledgment is completed.
- The notary public must print his or her name as it appears within his or her commission followed by a comma and then your title (notary public).
- Print the name(s) of document signer(s) who personally appear at the time of notarization.
- Indicate the correct singular or plural forms by crossing off incorrect forms (i.e. ~~he/she/they~~, is /are ) or circling the correct forms. Failure to correctly indicate this information may lead to rejection of document recording.
- The notary seal impression must be clear and photographically reproducible. Impression must not cover text or lines. If seal impression smudges, re-seal if a sufficient area permits, otherwise complete a different acknowledgment form.
- Signature of the notary public must match the signature on file with the office of the county clerk.
  - ❖ Additional information is not required but could help to ensure this acknowledgment is not misused or attached to a different document.
  - ❖ Indicate title or type of attached document, number of pages and date.
  - ❖ Indicate the capacity claimed by the signer. If the claimed capacity is a corporate officer, indicate the title (i.e. CEO, CFO, Secretary).
- Securely attach this document to the signed document with a staple.

**CALIFORNIA ACKNOWLEDGMENT**

CIVIL CODE § 1189

A notary public or other officer completing this certificate verifies only the identity of the individual who signed the document to which this certificate is attached, and not the truthfulness, accuracy, or validity of that document.

State of California }  
County of Orange }  
On DEC 17 2025 before me, J. Smith, Notary Public  
Date Here Insert Name and Title of the Officer  
personally appeared Christine Woolford  
Name(s) of Signer(s)

who proved to me on the basis of satisfactory evidence to be the person(s) whose name(s) is/are subscribed to the within instrument and acknowledged to me that he/she/they executed the same in his/her/their authorized capacity(ies), and that by his/her/their signature(s) on the instrument the person(s), or the entity upon behalf of which the person(s) acted, executed the instrument.

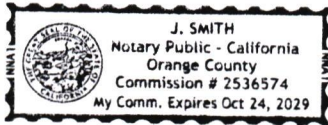

I certify under PENALTY OF PERJURY under the laws of the State of California that the foregoing paragraph is true and correct.

WITNESS my hand and official seal.

Signature J. Smith  
Signature of Notary Public

Place Notary Seal and/or Stamp Above

**OPTIONAL**

Completing this information can deter alteration of the document or fraudulent reattachment of this form to an unintended document.

**Description of Attached Document**

Title or Type of Document: \_\_\_\_\_

Document Date: \_\_\_\_\_ Number of Pages: \_\_\_\_\_

Signer(s) Other Than Named Above: \_\_\_\_\_

**Capacity(ies) Claimed by Signer(s)**

Signer's Name: \_\_\_\_\_ Signer's Name: \_\_\_\_\_

Corporate Officer – Title(s): \_\_\_\_\_  Corporate Officer – Title(s): \_\_\_\_\_

Partner –  Limited  General  Partner –  Limited  General

Individual  Attorney in Fact  Individual  Attorney in Fact

Trustee  Guardian or Conservator  Trustee  Guardian or Conservator

Other: \_\_\_\_\_  Other: \_\_\_\_\_

Signer is Representing: \_\_\_\_\_ Signer is Representing: \_\_\_\_\_

KNOW ALL BY THESE PRESENTS, that **Endurance Assurance Corporation**, a Delaware corporation ("EAC"), **Endurance American Insurance Company**, a Delaware corporation ("EAIC"), **Lexon Insurance Company**, a Texas corporation ("LIC"), and/or **Bond Safeguard Insurance Company**, a South Dakota corporation ("BSIC"), each, a "Company" and collectively, "**Sompo International**," do hereby constitute and appoint: **Yung T. Mullick, James W. Moilanen, Irene Luong, P. Austin Neff, Emilie George, Christine Woolford, Danielle Hanson** as true and lawful Attorney(s)-In-Fact to make, execute, seal, and deliver for, and on its behalf as surety or co-surety; bonds and undertakings given for any and all purposes, also to execute and deliver on its behalf as aforesaid renewals, extensions, agreements, waivers, consents or stipulations relating to such bonds or undertakings provided, however, that no single bond or undertaking so made, executed and delivered shall obligate the Company for any portion of the penal sum thereof in excess of the sum of **One Hundred Million Dollars (\$100,000,000.00)**.







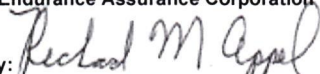

Such bonds and undertakings for said purposes, when duly executed by said attorney(s)-in-fact, shall be binding upon the Company as fully and to the same extent as if signed by the President of the Company under its corporate seal attested by its Corporate Secretary.

This appointment is made under and by authority of certain resolutions adopted by the board of directors of each Company by unanimous written consent effective the 30<sup>th</sup> day of March, 2023 for BSIC and LIC and the 17<sup>th</sup> day of May, 2023 for EAC and EAIC, a copy of which appears below under the heading entitled "Certificate".

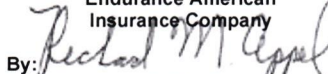
This Power of Attorney is signed and sealed by facsimile under and by authority of the following resolution adopted by the board of directors of each Company by unanimous written consent effective the 30<sup>th</sup> day of March, 2023 for BSIC and LIC and the 17<sup>th</sup> day of May, 2023 for EAC and EAIC and said resolution has not since been revoked, amended or repealed:

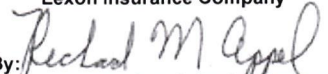
RESOLVED, that the signature of an individual named above and the seal of the Company may be affixed to any such power of attorney or any certificate relating thereto by facsimile, and any such power of attorney or certificate bearing such facsimile signature or seal shall be valid and binding upon the Company in the future with respect to any bond or undertaking to which it is attached.

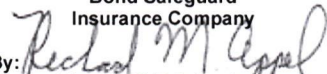
IN WITNESS WHEREOF, each Company has caused this instrument to be signed by the following officers, and its corporate seal to be affixed this 25th day of May, 2023.

<p><b>Endurance Assurance Corporation</b></p> <p>By:  Richard Appel; SVP &amp; Senior Counsel</p> 	<p><b>Endurance American Insurance Company</b></p> <p>By:  Richard Appel; SVP &amp; Senior Counsel</p> 	<p><b>Lexon Insurance Company</b></p> <p>By:  Richard Appel; SVP &amp; Senior Counsel</p> 	<p><b>Bond Safeguard Insurance Company</b></p> <p>By:  Richard Appel; SVP &amp; Senior Counsel</p> 
--	---	--	---

**ACKNOWLEDGEMENT**

On this 25th day of May, 2023, before me, personally came the above signatories known to me, who being duly sworn, did depose and say that he/she is an officer of each of the Companies; and that he executed said instrument on behalf of each Company by authority of his office under the by-laws of each Company.

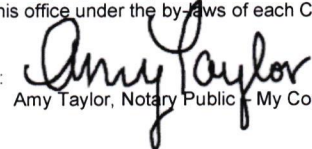
By:   
Amy Taylor, Notary Public - My Commission Expires 3/9/27



**CERTIFICATE**

I, the undersigned Officer of each Company, DO HEREBY CERTIFY that:

1. That the original power of attorney of which the foregoing is a copy was duly executed on behalf of each Company and has not since been revoked, amended or modified; that the undersigned has compared the foregoing copy thereof with the original power of attorney, and that the same is a true and correct copy of the original power of attorney and of the whole thereof;
2. The following are resolutions which were adopted by the board of directors of each Company by unanimous written consent effective 30<sup>th</sup> day of March, 2023 for BSIC and LIC and the 17<sup>th</sup> day of May, 2023 for EAC and EAIC and said resolutions have not since been revoked, amended or modified:

"RESOLVED, that each of the individuals named below is authorized to make, execute, seal and deliver for and on behalf of the Company any and all bonds, undertakings or obligations in surety or co-surety with others: RICHARD M. APPEL, MATTHEW E. CURRAN, MARGARET HYLAND, SHARON L. SIMS, CHRISTOPHER L. SPARRO,

and be it further

RESOLVED, that each of the individuals named above is authorized to appoint attorneys-in-fact for the purpose of making, executing, sealing and delivering bonds, undertakings or obligations in surety or co-surety for and on behalf of the Company."

3. The undersigned further certifies that the above resolutions are true and correct copies of the resolutions as so recorded and of the whole thereof.

IN WITNESS WHEREOF, I have hereunto set my hand and affixed the corporate seal this 17th day of December, 2025

By:   
Daniel S. Lurie, Secretary

**NOTICE: U. S. TREASURY DEPARTMENT'S OFFICE OF FOREIGN ASSETS CONTROL (OFAC)**

No coverage is provided by this Notice nor can it be construed to replace any provisions of any surety bond or other surety coverage provided. This Notice provides information concerning possible impact on your surety coverage due to directives issued by OFAC. **Please read this Notice carefully.**

The Office of Foreign Assets Control (OFAC) administers and enforces sanctions policy, based on Presidential declarations of "national emergency". OFAC has identified and listed numerous foreign agents, front organizations, terrorists, terrorist organizations, and narcotics traffickers as "Specially Designated Nationals and Blocked Persons". This list can be located on the United States Treasury's website - <https://www.treasury.gov/resource-center/sanctions/SDN-List>.

In accordance with OFAC regulations, if it is determined that you or any other person or entity claiming the benefits of any coverage has violated U.S. sanctions law or is a Specially Designated National and Blocked Person, as identified by OFAC, any coverage will be considered a blocked or frozen contract and all provisions of any coverage provided are immediately subject to OFAC. When a surety bond or other form of surety coverage is considered to be such a blocked or frozen contract, no payments nor premium refunds may be made without authorization from OFAC. Other limitations on the premiums and payments may also apply.

Any reproductions are void.

Surety Claims Submission: [LexonClaimAdministration@sompo-intl.com](mailto:LexonClaimAdministration@sompo-intl.com)

Telephone: 615-553-9500 Mailing Address: Sompo International; 12890 Lebanon Road; Mount Juliet, TN 37122-2870

- Company Profile
- Company Search
- Company Search Results
- Company Information
- Old Company Names
- Agent for Service
- Reference Information
- NAIC Group List
- Lines of Business
- Workers' Compensation
- Complaint and Request for Action/Appeals
- Contact Information

- Financial Statements PDF's
- Annual Statements
- Quarterly Statements
- Company Complaint
- Company Performance & Comparison Data
- Company Enforcement Action
- Composite Complaints Studies

- Additional Info
- Find A Company Representative In Your Area
- View Financial Disclaimer

**COMPANY PROFILE**

**Company Information**

**ENDURANCE ASSURANCE CORPORATION**  
**4 MANHATTANVILLE ROAD, 3RD FLOOR**  
**NEW YORK, NY 10577**

<b>Old Company Names</b>	<b>Effective Date</b>
ENDURANCE REINSURANCE COMPANY OF AMERICA	01/30/2008
ENDURANCE REINSURANCE CORPORATION OF AMERICA	08/23/2016
ENDURANCE REINSURANCE CORPORATION OF AMERICA DBA	
ENDURANCE WORKERS' COMPENSATION INSURANCE COMPANY	12/30/2009

**Agent For Service**

AMANDA GARCIA  
 330 N Brand Blvd Ste 700  
 Glendale CA 91203

**Reference Information**

NAIC #:	11551
California Company ID #:	5082-3
Date Authorized in California:	01/30/2008
License Status:	UNLIMITED-NORMAL
Company Type:	Property & Casualty
State of Domicile:	DELAWARE

[back to top](#)

**NAIC Group List**

NAIC Group #: [3219](#) Sompo Grp

**Lines Of Business**

The company is authorized to transact business within these lines of insurance. For an explanation of any of these terms, please refer to the [glossary](#).

- AIRCRAFT
- AUTOMOBILE
- BOILER AND MACHINERY
- BURGLARY
- COMMON CARRIER LIABILITY
- CREDIT
- DISABILITY
- FIRE
- LEGAL INSURANCE
- LIABILITY
- MARINE
- MISCELLANEOUS
- PLATE GLASS
- SPRINKLER
- SURETY
- TEAM AND VEHICLE
- WORKERS' COMPENSATION

[back to top](#)

### Payment Bond

(Public Works - Civil Code §9550 et seq.)

The makers of this Bond are **California Professional Engineering, Inc.** as Principal and Original Contractor and Endurance Assurance Corporation, a corporation, authorized to issue Surety Bonds in California, as Surety, and this Bond is issued in conjunction with that certain public works contract to be executed between Principal and COUNTY OF RIVERSIDE a public entity, as Owner, for **\$341,649.18 (Three hundred forty-one thousand, six hundred forty-nine dollars and eighteen cents)** the total amount payable. The amount of this bond is one hundred percent (100%) of said sum. Said contract is for public work generally consisting of **Cajalco Road and Carroll Street, Traffic Signal and Safety Lighting Project, Community of Mead Valley, Project No. D3-0115.**

The beneficiaries of this Bond are as is stated in 9554 of the Civil Code and requirements and conditions of this Bond are as is set forth in 9554, 9558, 9560 and 9564 of said code. Without notice, Surety consents to extension of time for performance, change in requirements, amount of compensation, or prepayment under said contract.

Dated: December 17, 2025

California Professional Engineering, Inc.

Original Contractor – Principal

Endurance Assurance Corporation

Surety

By \_\_\_\_\_

Christine Woolford  
Its Attorney In Fact

(Corporate Seal)

By \_\_\_\_\_

Title Van Nguyen, President

(If corporation, affix seal)

(Corporate Seal)

STATE OF \_\_\_\_\_ }  
COUNTY OF \_\_\_\_\_ }

ss. SURETY'S ACKNOWLEDGEMENT

On \_\_\_\_\_ before me, \_\_\_\_\_ personally appeared, \_\_\_\_\_, known to me, or proved to me on the basis of satisfactory evidence, to be the person whose name is subscribed to the within instrument and acknowledged to me that he executed the same in his authorized capacities, and that by his signature on the instrument the person, or the entity upon behalf of which the person acted, executed the instrument.

WITNESS my hand and official seal.

\_\_\_\_\_  
Signature of Notary Public

Notary Public (Seal)

**NOTE: This Bond must be executed by both parties with corporate seal affixed. All signatures must be acknowledged. (Attach acknowledgements).**

# CALIFORNIA ALL- PURPOSE CERTIFICATE OF ACKNOWLEDGMENT

A notary public or other officer completing this certificate verifies only the identity of the individual who signed the document to which this certificate is attached, and not the truthfulness, accuracy, or validity of that document.

State of California }

County of Los Angeles }

On December 18, 2025 before me, Diem Chu, Notary Public,  
(Here insert name and title of the officer)

personally appeared Van Nguyen,  
who proved to me on the basis of satisfactory evidence to be the person(s) whose name(s) is/are subscribed to the within instrument and acknowledged to me that he/she/they executed the same in his/her/their authorized capacity(ies), and that by his/her/their signature(s) on the instrument the person(s), or the entity upon behalf of which the person(s) acted, executed the instrument.

I certify under PENALTY OF PERJURY under the laws of the State of California that the foregoing paragraph is true and correct.

WITNESS my hand and official seal.

  
\_\_\_\_\_  
Notary Public Signature

(Notary Public Seal)

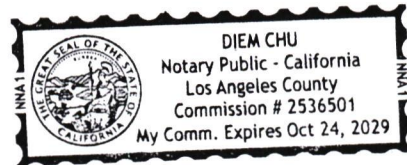

## ADDITIONAL OPTIONAL INFORMATION

### DESCRIPTION OF THE ATTACHED DOCUMENT

\_\_\_\_\_  
(Title or description of attached document)

\_\_\_\_\_  
(Title or description of attached document continued)

Number of Pages \_\_\_\_\_ Document Date \_\_\_\_\_

### CAPACITY CLAIMED BY THE SIGNER

- Individual (s)
- Corporate Officer  
President, Secretary  
(Title)
- Partner(s)
- Attorney-in-Fact
- Trustee(s)
- Other \_\_\_\_\_

## INSTRUCTIONS FOR COMPLETING THIS FORM

*This form complies with current California statutes regarding notary wording and, if needed, should be completed and attached to the document. Acknowledgments from other states may be completed for documents being sent to that state so long as the wording does not require the California notary to violate California notary law.*

- State and County information must be the State and County where the document signer(s) personally appeared before the notary public for acknowledgment.
- Date of notarization must be the date that the signer(s) personally appeared which must also be the same date the acknowledgment is completed.
- The notary public must print his or her name as it appears within his or her commission followed by a comma and then your title (notary public).
- Print the name(s) of document signer(s) who personally appear at the time of notarization.
- Indicate the correct singular or plural forms by crossing off incorrect forms (i.e. ~~he/she/they~~, is /are ) or circling the correct forms. Failure to correctly indicate this information may lead to rejection of document recording.
- The notary seal impression must be clear and photographically reproducible. Impression must not cover text or lines. If seal impression smudges, re-seal if a sufficient area permits, otherwise complete a different acknowledgment form.
- Signature of the notary public must match the signature on file with the office of the county clerk.
  - ❖ Additional information is not required but could help to ensure this acknowledgment is not misused or attached to a different document.
  - ❖ Indicate title or type of attached document, number of pages and date.
  - ❖ Indicate the capacity claimed by the signer. If the claimed capacity is a corporate officer, indicate the title (i.e. CEO, CFO, Secretary).
- Securely attach this document to the signed document with a staple.

**CALIFORNIA ACKNOWLEDGMENT**

CIVIL CODE § 1189

A notary public or other officer completing this certificate verifies only the identity of the individual who signed the document to which this certificate is attached, and not the truthfulness, accuracy, or validity of that document.

State of California }  
County of Orange }  
On DEC 17 2025 before me, J. Smith, Notary Public  
Date Here insert Name and Title of the Officer  
personally appeared Christine Woolford  
Name(s) of Signer(s)

who proved to me on the basis of satisfactory evidence to be the person(s) whose name(s) is/are subscribed to the within instrument and acknowledged to me that he/she/they executed the same in his/her/their authorized capacity(ies), and that by his/her/their signature(s) on the instrument the person(s), or the entity upon behalf of which the person(s) acted, executed the instrument.

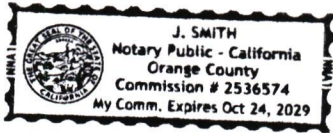

I certify under PENALTY OF PERJURY under the laws of the State of California that the foregoing paragraph is true and correct.

WITNESS my hand and official seal.

Place Notary Seal and/or Stamp Above

Signature J. Smith  
Signature of Notary Public

**OPTIONAL**

Completing this information can deter alteration of the document or fraudulent reattachment of this form to an unintended document.

**Description of Attached Document**

Title or Type of Document: \_\_\_\_\_

Document Date: \_\_\_\_\_ Number of Pages: \_\_\_\_\_

Signer(s) Other Than Named Above: \_\_\_\_\_

**Capacity(ies) Claimed by Signer(s)**

Signer's Name: \_\_\_\_\_ Signer's Name: \_\_\_\_\_

Corporate Officer – Title(s): \_\_\_\_\_  Corporate Officer – Title(s): \_\_\_\_\_

Partner –  Limited  General  Partner –  Limited  General

Individual  Attorney in Fact  Individual  Attorney in Fact

Trustee  Guardian or Conservator  Trustee  Guardian or Conservator

Other: \_\_\_\_\_  Other: \_\_\_\_\_

Signer is Representing: \_\_\_\_\_ Signer is Representing: \_\_\_\_\_

KNOW ALL BY THESE PRESENTS, that **Endurance Assurance Corporation**, a Delaware corporation ("EAC"), **Endurance American Insurance Company**, a Delaware corporation ("EAIC"), **Lexon Insurance Company**, a Texas corporation ("LIC"), and/or **Bond Safeguard Insurance Company**, a South Dakota corporation ("BSIC"), each, a "Company" and collectively, "**Sompo International**," do hereby constitute and appoint: **Yung T. Mullick, James W. Moilanen, Irene Luong, P. Austin Neff, Emilie George, Christine Woolford, Danielle Hanson** as true and lawful Attorney(s)-In-Fact to make, execute, seal, and deliver for, and on its behalf as surety or co-surety; bonds and undertakings given for any and all purposes, also to execute and deliver on its behalf as aforesaid renewals, extensions, agreements, waivers, consents or stipulations relating to such bonds or undertakings provided, however, that no single bond or undertaking so made, executed and delivered shall obligate the Company for any portion of the penal sum thereof in excess of the sum of **One Hundred Million Dollars (\$100,000,000.00)**.





Such bonds and undertakings for said purposes, when duly executed by said attorney(s)-in-fact, shall be binding upon the Company as fully and to the same extent as if signed by the President of the Company under its corporate seal attested by its Corporate Secretary.

This appointment is made under and by authority of certain resolutions adopted by the board of directors of each Company by unanimous written consent effective the 30<sup>th</sup> day of March, 2023 for BSIC and LIC and the 17<sup>th</sup> day of May, 2023 for EAC and EAIC, a copy of which appears below under the heading entitled "Certificate".

This Power of Attorney is signed and sealed by facsimile under and by authority of the following resolution adopted by the board of directors of each Company by unanimous written consent effective the 30<sup>th</sup> day of March, 2023 for BSIC and LIC and the 17<sup>th</sup> day of May, 2023 for EAC and EAIC and said resolution has not since been revoked, amended or repealed:

RESOLVED, that the signature of an individual named above and the seal of the Company may be affixed to any such power of attorney or any certificate relating thereto by facsimile, and any such power of attorney or certificate bearing such facsimile signature or seal shall be valid and binding upon the Company in the future with respect to any bond or undertaking to which it is attached.

IN WITNESS WHEREOF, each Company has caused this instrument to be signed by the following officers, and its corporate seal to be affixed this 25th day of May, 2023.

<p><b>Endurance Assurance Corporation</b></p> <p>By: <i>Richard M Appel</i> Richard Appel; SVP &amp; Senior Counsel</p> 	<p><b>Endurance American Insurance Company</b></p> <p>By: <i>Richard M Appel</i> Richard Appel; SVP &amp; Senior Counsel</p> 	<p><b>Lexon Insurance Company</b></p> <p>By: <i>Richard M Appel</i> Richard Appel; SVP &amp; Senior Counsel</p> 	<p><b>Bond Safeguard Insurance Company</b></p> <p>By: <i>Richard M Appel</i> Richard Appel; SVP &amp; Senior Counsel</p> 
---	--	--	--

**ACKNOWLEDGEMENT**

On this 25th day of May, 2023, before me, personally came the above signatories known to me, who being duly sworn, did depose and say that he/she is an officer of each of the Companies; and that he executed said instrument on behalf of each Company by authority of his office under the by-laws of each Company.

By: *Amy Taylor*  
Amy Taylor, Notary Public - My Commission Expires 3/9/27



**CERTIFICATE**

I, the undersigned Officer of each Company, DO HEREBY CERTIFY that:

1. That the original power of attorney of which the foregoing is a copy was duly executed on behalf of each Company and has not since been revoked, amended or modified; that the undersigned has compared the foregoing copy thereof with the original power of attorney, and that the same is a true and correct copy of the original power of attorney and of the whole thereof;
2. The following are resolutions which were adopted by the board of directors of each Company by unanimous written consent effective 30<sup>th</sup> day of March, 2023 for BSIC and LIC and the 17<sup>th</sup> day of May, 2023 for EAC and EAIC and said resolutions have not since been revoked, amended or modified:

"RESOLVED, that each of the individuals named below is authorized to make, execute, seal and deliver for and on behalf of the Company any and all bonds, undertakings or obligations in surety or co-surety with others: RICHARD M. APPEL, MATTHEW E. CURRAN, MARGARET HYLAND, SHARON L. SIMS, CHRISTOPHER L. SPARRO,

and be it further

RESOLVED, that each of the individuals named above is authorized to appoint attorneys-in-fact for the purpose of making, executing, sealing and delivering bonds, undertakings or obligations in surety or co-surety for and on behalf of the Company."

3. The undersigned further certifies that the above resolutions are true and correct copies of the resolutions as so recorded and of the whole thereof.

IN WITNESS WHEREOF, I have hereunto set my hand and affixed the corporate seal this 17th day of December, 2025.

By: *Daniel S. Lurie*  
Daniel S. Lurie, Secretary

**NOTICE: U. S. TREASURY DEPARTMENT'S OFFICE OF FOREIGN ASSETS CONTROL (OFAC)**

No coverage is provided by this Notice nor can it be construed to replace any provisions of any surety bond or other surety coverage provided. This Notice provides information concerning possible impact on your surety coverage due to directives issued by OFAC. **Please read this Notice carefully.**

The Office of Foreign Assets Control (OFAC) administers and enforces sanctions policy, based on Presidential declarations of "national emergency". OFAC has identified and listed numerous foreign agents, front organizations, terrorists, terrorist organizations, and narcotics traffickers as "Specially Designated Nationals and Blocked Persons". This list can be located on the United States Treasury's website - <https://www.treasury.gov/resource-center/sanctions/SDN-List>.

In accordance with OFAC regulations, if it is determined that you or any other person or entity claiming the benefits of any coverage has violated U.S. sanctions law or is a Specially Designated National and Blocked Person, as identified by OFAC, any coverage will be considered a blocked or frozen contract and all provisions of any coverage provided are immediately subject to OFAC. When a surety bond or other form of surety coverage is considered to be such a blocked or frozen contract, no payments nor premium refunds may be made without authorization from OFAC. Other limitations on the premiums and payments may also apply.

Any reproductions are void.

Surety Claims Submission: [LexonClaimAdministration@sompo-intl.com](mailto:LexonClaimAdministration@sompo-intl.com)

Telephone: 615-553-9500 Mailing Address: Sompo International; 12890 Lebanon Road; Mount Juliet, TN 37122-2870

- Company Profile
- Company Search
- Company Search Results
- Company Information
- Old Company Names
- Agent for Service
- Reference Information
- NAIC Group List
- Lines of Business
- Workers' Compensation
- Complaint and Request for Action/Appeals
- Contact Information

Financial Statements PDF's

- Annual Statements
- Quarterly Statements

Company Complaint

- Company Performance & Comparison Data
- Company Enforcement Action
- Composite Complaints Studies

Additional Info

- Find A Company Representative In Your Area
- View Financial Disclaimer

**COMPANY PROFILE**

**Company Information**

**ENDURANCE ASSURANCE CORPORATION**  
**4 MANHATTANVILLE ROAD, 3RD FLOOR**  
**NEW YORK, NY 10577**

Old Company Names	Effective Date
ENDURANCE REINSURANCE COMPANY OF AMERICA	01/30/2008
ENDURANCE REINSURANCE CORPORATION OF AMERICA	08/23/2016
ENDURANCE REINSURANCE CORPORATION OF AMERICA DBA	12/30/2009
ENDURANCE WORKERS' COMPENSATION INSURANCE COMPANY	

**Agent For Service**

AMANDA GARCIA  
 330 N Brand Blvd Ste 700  
 Glendale CA 91203

**Reference Information**

NAIC #:	11551
California Company ID #:	5082-3
Date Authorized in California:	01/30/2008
License Status:	UNLIMITED-NORMAL
Company Type:	Property & Casualty
State of Domicile:	DELAWARE

[back to top](#)

**NAIC Group List**

NAIC Group #: [3219](#) Sompo Grp

**Lines Of Business**

The company is authorized to transact business within these lines of insurance. For an explanation of any of these terms, please refer to the [glossary](#).

- AIRCRAFT
- AUTOMOBILE
- BOILER AND MACHINERY
- BURGLARY
- COMMON CARRIER LIABILITY
- CREDIT
- DISABILITY
- FIRE
- LEGAL INSURANCE
- LIABILITY
- MARINE
- MISCELLANEOUS
- PLATE GLASS
- SPRINKLER
- SURETY
- TEAM AND VEHICLE
- WORKERS' COMPENSATION

[back to top](#)





### ADDITIONAL REMARKS SCHEDULE

AGENCY <b>Duran Risk &amp; Insurance Services</b>		License # 0252636	NAMED INSURED California Professional Engineering Inc. 19062 San Jose Avenue La Puente, CA 91748
POLICY NUMBER <b>SEE PAGE 1</b>			
CARRIER <b>SEE PAGE 1</b>	NAIC CODE <b>SEE P 1</b>	EFFECTIVE DATE: <b>SEE PAGE 1</b>	

**ADDITIONAL REMARKS**

THIS ADDITIONAL REMARKS FORM IS A SCHEDULE TO ACORD FORM,  
FORM NUMBER: ACORD 25 FORM TITLE: Certificate of Liability Insurance

**Description of Operations/Locations/Vehicles:**  
Liability per form CA20481013. A waiver of subrogation in favor of County of Riverside, its Agencies, Special Districts and Departments, their respective director, officers, Board of Supervisors, elected and appointed officials, employees, agents, and representatives applies with respect to Workers' Compensation Liability per form WC900375(05/18).

\*At least 30 day written notice of cancellation. 10 days notice for nonpayment of premium.

**THIS ENDORSEMENT CHANGES THE POLICY. PLEASE READ IT CAREFULLY.**

## ADDITIONAL INSURED – OWNERS, LESSEES OR CONTRACTORS – SCHEDULED PERSON OR ORGANIZATION

This endorsement modifies insurance provided under the following:

COMMERCIAL GENERAL LIABILITY COVERAGE PART

### SCHEDULE

Name Of Additional Insured Person(s) Or Organization(s)	Location(s) Of Covered Operations
<p><b>Any person or organization for whom you are performing operations when you and such person or organization have agreed in writing in a contract or agreement that such person or organization be added as an additional insured on your policy.</b></p>	<p>N/A</p>
<p>Information required to complete this Schedule, if not shown above, will be shown in the Declarations.</p>	

**A. Section II – Who Is An Insured** is amended to include as an additional insured the person(s) or organization(s) shown in the Schedule, but only with respect to liability for "bodily injury", "property damage" or "personal and advertising injury" caused, in whole or in part, by:

1. Your acts or omissions; or
2. The acts or omissions of those acting on your behalf;

in the performance of your ongoing operations for the additional insured(s) at the location(s) designated above.

However:

1. The insurance afforded to such additional insured only applies to the extent permitted by law; and
2. If coverage provided to the additional insured is required by a contract or agreement, the insurance afforded to such additional insured will not be broader than that which you are required by the contract or agreement to provide for such additional insured.

**B.** With respect to the insurance afforded to these additional insureds, the following additional exclusions apply:

This insurance does not apply to "bodily injury" or "property damage" occurring after:

1. All work, including materials, parts or equipment furnished in connection with such work, on the project (other than service, maintenance or repairs) to be performed by or on behalf of the additional insured(s) at the location of the covered operations has been completed; or
2. That portion of "your work" out of which the injury or damage arises has been put to its intended use by any person or organization other than another contractor or subcontractor engaged in performing operations for a principal as a part of the same project.

C. With respect to the insurance afforded to these additional insureds, the following is added to **Section III – Limits Of Insurance:**

If coverage provided to the additional insured is required by a contract or agreement, the most we will pay on behalf of the additional insured is the amount of insurance:

1. Required by the contract or agreement; or

2. Available under the applicable Limits of Insurance shown in the Declarations; whichever is less.

This endorsement shall not increase the applicable Limits of Insurance shown in the Declarations.



---

Authorized Agent

THIS ENDORSEMENT CHANGES THE POLICY. PLEASE READ IT CAREFULLY.

## ADDITIONAL INSURED – OWNERS, LESSEES OR CONTRACTORS – COMPLETED OPERATIONS

This endorsement modifies insurance provided under the following:

COMMERCIAL GENERAL LIABILITY COVERAGE PART  
PRODUCTS/COMPLETED OPERATIONS LIABILITY COVERAGE PART

### SCHEDULE

Name Of Additional Insured Person(s) Or Organization(s)	Location And Description Of Completed Operations
Any person or organization for whom you are performing "commercial construction" during the period of this policy and have agreed in a written contract to add as an additional insured for products-completed operations. "Commercial construction" does not include any habitational or residential construction other than hotels or apartments.	N/A
Information required to complete this Schedule, if not shown above, will be shown in the Declarations.	

**A. Section II – Who Is An Insured** is amended to include as an additional insured the person(s) or organization(s) shown in the Schedule, but only with respect to liability for "bodily injury" or "property damage" caused, in whole or in part, by "your work" at the location designated and described in the Schedule of this endorsement performed for that additional insured and included in the "products-completed operations hazard".

However:

1. The insurance afforded to such additional insured only applies to the extent permitted by law; and
2. If coverage provided to the additional insured is required by a contract or agreement, the insurance afforded to such additional insured will not be broader than that which you are required by the contract or agreement to provide for such additional insured.

**B.** With respect to the insurance afforded to these additional insureds, the following is added to **Section III – Limits Of Insurance:**

If coverage provided to the additional insured is required by a contract or agreement, the most we will pay on behalf of the additional insured is the amount of insurance:

1. Required by the contract or agreement; or
2. Available under the applicable Limits of Insurance shown in the Declarations;

whichever is less.

This endorsement shall not increase the applicable Limits of Insurance shown in the Declarations.



Authorized Agent

**THIS ENDORSEMENT CHANGES THE POLICY. PLEASE READ IT CAREFULLY.**

## **DESIGNATED INSURED FOR COVERED AUTOS LIABILITY COVERAGE**

This endorsement modifies insurance provided under the following:

AUTO DEALERS COVERAGE FORM  
BUSINESS AUTO COVERAGE FORM  
MOTOR CARRIER COVERAGE FORM

With respect to coverage provided by this endorsement, the provisions of the Coverage Form apply unless modified by this endorsement.

This endorsement identifies person(s) or organization(s) who are "insureds" for Covered Autos Liability Coverage under the Who Is An Insured provision of the Coverage Form. This endorsement does not alter coverage provided in the Coverage Form.

This endorsement changes the policy effective on the inception date of the policy unless another date is indicated below.

**Named Insured:** California Professional Engineering, Inc.  
**Endorsement Effective Date:** 05/19/2025

### **SCHEDULE**

**Name Of Person(s) Or Organization(s):** As required by written contract so long as the contract was entered into prior to the date of loss.

Information required to complete this Schedule, if not shown above, will be shown in the Declarations.

Each person or organization shown in the Schedule is an "insured" for Covered Autos Liability Coverage, but only to the extent that person or organization qualifies as an "insured" under the Who Is An Insured provision contained in Paragraph **A.1.** of Section **II** - Covered Autos Liability Coverage in the Business Auto and Motor Carrier Coverage Forms and Paragraph **D.2.** of Section **I** - Covered Autos Coverages of the Auto Dealers Coverage Form.



Authorized Agent

**Workers' Compensation and Employers' Liability Policy**

Named Insured Barrett Business Services, Inc. L/C/F CALIFORNIA PROFESSIONAL ENGINEERING INC 19062 SAN JOSE AVE LA PUENTE, CA 91748	Endorsement Number
	Policy Number Symbol: WLR Number: 912981

Policy Period <b>5/19/2025 - 5/19/2026</b>	Effective Date of Endorsement <b>5/19/2025</b>
---	---

Issued By (Name of the Insurance Company)  
Ace American Insurance Co.

Insert the policy number. The remainder of the information is to be completed only when this endorsement is issued subsequent to the preparation of the policy. This endorsement changes the policy to which it is attached and is effective on the date issued unless otherwise stated.

**CALIFORNIA WAIVER OF OUR RIGHT TO RECOVER FROM OTHERS ENDORSEMENT**

This endorsement applies only to the insurance provided by the policy because California is shown in Item 3.A. of the Information Page.

We have the right to recover our payments from anyone liable for an injury covered by this policy. We will not enforce our right against the person or organization named in the Schedule, but this waiver applies only with respect to bodily injury arising out of the operations described in the Schedule, where you are required by a written contract to obtain this waiver from us.

You must maintain payroll records accurately segregating the remuneration of your employees while engaged in the work described in the Schedule.

Schedule

- 1. ( ) Specific Waiver  
Name of person or organization:
  
  
  
  
  
  
  
  
  
  
- (X) Blanket Waiver  
Any person or organization for whom the Named Insured has agreed by written contract to furnish this waiver.
  
- 2. Operations:  
ALL CALIFORNIA OPERATIONS
  
  
  
  
  
  
- 3. Premium:  
The premium charge for this endorsement shall be 1.0 percent of the California premium developed on payroll in connection with work performed for the above person(s) or organization(s) arising out of the operations described.
  
- 4. Minimum Premium: \$0

  
\_\_\_\_\_  
Authorized Agent





**COMMERCIAL EXCESS LIABILITY POLICY  
DECLARATIONS**

POLICY NO. NHA606723

ITEM 6. SCHEDULE OF UNDERLYING INSURANCE

Type of Policy	Insurer	Applicable Limit
GENERAL LIABILITY	HOMESITE INSURANCE COMPANY	\$1,000,000 EACH OCCURRENCE \$2,000,000 GENERAL AGGREGATE \$2,000,000 PRODUCTS/COMPLETED OPS AGG \$1,000,000 PERSONAL/ADVERTISING INJURY
AUTO LIABILITY	MS TRANSVERSE SPECIALTY INSURANCE COMPANY	\$1,000,000 COMBINED SINGLE LIMIT
EMPLOYERS LIABILITY	TRAVELERS PROPERTY CASUALTY COMPANY OF AMERICA	\$1,000,000 EACH ACCIDENT \$1,000,000 DISEASE EACH EMPLOYEE \$1,000,000 DISEASE POLICY LIMIT

- Company Profile
- Company Search
- Company Search Results
- Company Information
- Old Company Names
- Agent for Service Reference Information
- NAIC Group List
- Lines of Business
- Workers' Compensation Complaint and Request for Action/Appeals Contact Information
- Financial Statements PDF's
- Annual Statements
- Quarterly Statements
- Company Complaint
- Company Performance & Comparison Data
- Company Enforcement Action
- Composite Complaints Studies
- Additional Info
- Find A Company Representative In Your Area
- View Financial Disclaimer

**COMPANY PROFILE**

**Company Information**

**HOMESITE INSURANCE COMPANY OF CALIFORNIA**

**290 CONGRESS ST STE 400  
BOSTON, MA 02210  
800-466-3748**

**Old Company Names**

**Effective Date**

**Agent For Service**

Melissa DeKoven  
2710 Gateway Oaks Drive, Suite 150N  
Sacramento CA 95833-3505

**Reference Information**

NAIC #:	11005
California Company ID #:	4620-1
Date Authorized in California:	12/06/1999
License Status:	UNLIMITED-NORMAL
Company Type:	Property & Casualty
State of Domicile:	CALIFORNIA

[back to top](#)

**NAIC Group List**

NAIC Group #: **0473** AMERICAN FAMILY INS GRP

**Lines Of Business**

The company is authorized to transact business within these lines of insurance. For an explanation of any of these terms, please refer to the [glossary](#).

- BOILER AND MACHINERY
- BURGLARY
- FIRE
- LIABILITY
- MARINE
- MISCELLANEOUS
- PLATE GLASS
- SPRINKLER
- TEAM AND VEHICLE

[back to top](#)

[Back to Top](#)

## M - P

<b>Insurer</b>	<b>Date Approved</b>
The Marine Insurance Company Limited (UK)	11/03/1995
Markel International Insurance Company Limited (U.K.) (Name changed from Terra Nova Insurance Company Limited, effective 11/04/2002)	10/27/1995
Maxum Indemnity Company (Connecticut) (Domicile changed from Delaware to Connecticut effective 12/01/2016) (Name changed from Caliber One Indemnity Company, effective 01/02/2003)	09/29/1998
Medical Security Insurance Company (North Carolina)	12/18/2023
Mercer Insurance Company (Pennsylvania)	06/10/2016
Mesa Underwriters Specialty Insurance Company (New Jersey) (Name changed from Montpelier U.S. Insurance Company, effective 01/01/2012.) (Domicile changed from Oklahoma to New Jersey, effective 01/01/2012)	02/05/2012
Mitsui Sumitomo Insurance Company (Europe) Limited (U.K.)	06/10/2011
Mount Vernon Fire Insurance Company (Pennsylvania)	04/02/1997
MS Transverse Specialty Insurance Company (Texas) (Name changed from Transverse Specialty Insurance Company (Texas) effective 01/18/2024)	10/31/2022
MSIG Specialty Insurance USA Inc. (New York)	10/11/2019
Mt. Hawley Insurance Company (Illinois) (Domicile changed from Delaware to Kansas, effective 12/20/1995. Domicile changed from Kansas to Illinois effective 04/21/1999)	10/27/1995
NORCAL Specialty Insurance Company (Texas) (Domicile changed from Pennsylvania to Texas effective 04/25/2018) (Name changed from PMSLIC Insurance Company, effective 12/01/2015)	12/23/2013
National Fire & Marine Insurance Company (Nebraska)	06/30/1995
Nautilus Insurance Company (Arizona)	08/04/1995
Navigators Specialty Insurance Company (New York) (Name changed from NIC Insurance Company effective 01/04/2007)	12/08/1995
Northfield Insurance Company (Iowa) (Domicile changed from Missouri to Iowa, effective 01/01/2002)	06/30/1995
North Light Specialty Insurance Company (Illinois)	10/10/2014
Nutmeg Insurance Company (Connecticut)	06/30/1995
Oklahoma Specialty Insurance Company (Oklahoma)	12/05/2024
Old Republic Union Insurance Company (Illinois)	05/24/2017
Pacific Insurance Company, Limited (Connecticut)	09/01/1995
Penn-Star Insurance Company (Pennsylvania)	11/13/2002
Point Excess & Surplus Insurance Company (Wisconsin)	11/26/2024
Prime Insurance Company (Illinois)	08/08/2018
Princeton Excess and Surplus Lines Insurance Company (Delaware)	02/09/2006

- Company Profile
- Company Search
- Company Search Results
- Company Information
- Old Company Names
- Agent for Service
- Reference Information
- NAIC Group List
- Lines of Business
- Workers' Compensation Complaint and Request for Action/Appeals Contact Information

- Financial Statements PDF's
- Annual Statements
- Quarterly Statements
- Company Complaint
- Company Performance & Comparison Data
- Company Enforcement Action
- Composite Complaints Studies

- Additional Info
- Find A Company Representative In Your Area
- View Financial Disclaimer

**COMPANY PROFILE**

**Company Information**

**RSUI INDEMNITY COMPANY**  
**945 EAST PACES FERRY RD, SUITE 1800**  
**ATLANTA, GA 30326**

Old Company Names	Effective Date
BUFFALO REINSURANCE COMPANY	12/28/1987
UNDERWRITERS REINSURANCE COMPANY	02/06/2004

**Agent For Service**

Melissa DeKoven  
 2710 Gateway Oaks Drive, Suite 150N  
 Sacramento CA 95833-3505

**Reference Information**

NAIC #:	22314
California Company ID #:	2269-9
Date Authorized in California:	01/01/1978
License Status:	UNLIMITED-NORMAL
Company Type:	Property & Casualty
State of Domicile:	NEW HAMPSHIRE

[back to top](#)

**NAIC Group List**

NAIC Group #: 0031    BERKSHIRE HATHAWAY GRP

**Lines Of Business**

The company is authorized to transact business within these lines of insurance. For an explanation of any of these terms, please refer to the [glossary](#).

- AIRCRAFT
- AUTOMOBILE
- BOILER AND MACHINERY
- BURGLARY
- COMMON CARRIER LIABILITY
- CREDIT
- DISABILITY
- FIRE
- LIABILITY
- MARINE
- MISCELLANEOUS
- PLATE GLASS
- SPRINKLER
- SURETY
- TEAM AND VEHICLE
- WORKERS' COMPENSATION

- Company Profile
- Company Search
- Company Search Results
- Company Information
- Old Company Names
- Agent for Service Reference Information
- NAIC Group List
- Lines of Business
- Workers' Compensation
- Complaint and Request for Action/Appeals
- Contact Information
- Financial Statements PDF's
- Annual Statements
- Quarterly Statements
- Company Complaint
- Company Performance & Comparison Data
- Company Enforcement Action
- Composite Complaints Studies
- Additional Info
- Find A Company Representative In Your Area
- View Financial Disclaimer

**COMPANY PROFILE**

**Company Information**

**ACE AMERICAN INSURANCE COMPANY**

**436 WALNUT STREET  
PHILADELPHIA, PA 19106  
800-352-4462**

<b>Old Company Names</b>	<b>Effective Date</b>
ALLIED COMPENSATION INSURANCE COMPANY	04/03/1961
ALLIED INSURANCE COMPANY	12/14/1977
CIGNA INSURANCE COMPANY	11/01/1999
INA UNDERWRITERS INSURANCE COMPANY	12/31/1983

**Agent For Service**

AMANDA GARCIA  
330 N Brand Blvd Ste 700  
Glendale CA 91203

**Reference Information**

NAIC #:	22667
California Company ID #:	1325-0
Date Authorized in California:	12/20/1945
License Status:	UNLIMITED-NORMAL
Company Type:	Property & Casualty
State of Domicile:	PENNSYLVANIA

[back to top](#)

**NAIC Group List**

NAIC Group #: [0626](#) Chubb Ltd Grp

**Lines Of Business**

The company is authorized to transact business within these lines of insurance. For an explanation of any of these terms, please refer to the [glossary](#).

- AIRCRAFT
- AUTOMOBILE
- BOILER AND MACHINERY
- BURGLARY
- COMMON CARRIER LIABILITY
- CREDIT
- DISABILITY
- FIRE
- LIABILITY
- MARINE
- MISCELLANEOUS
- PLATE GLASS
- SPRINKLER
- SURETY
- TEAM AND VEHICLE
- WORKERS' COMPENSATION

[back to top](#)

## Bid

Date: 11/26/25

To: County of Riverside, hereafter called "County";

Bidder: California Professional Engineering Inc.  
(hereafter called "Contractor")

The undersigned, Contractor, having carefully examined the site and the Contract Documents for the construction of Cajalco Road and Carroll Street, Traffic Signal and Safety Lighting Project, Community of Mead Valley, Project No. D3-0115 hereby proposes to construct the work in accordance with the Contract Documents, including **Addenda Number(s)** 1, 2, 3 (Fill in addenda numbers if addenda have been issued.) for the amount stated in this Bid.

By submitting this Bid, Contractor agrees with County:

1. That unless withdrawn in person by Contractor or some person authorized in writing by Contractor (not by telephone or facsimile) before the time specified in the Notice Inviting Bids for the public opening of bids, this Bid constitutes an irrevocable offer for 90 calendar days after that date.
2. County has the right to reject any or all Bids and to waive any irregularities or informalities contained in a Bid.
3. To execute the Contract and deliver the Performance Bond, Payment Bond and Insurance Certificate with endorsements, that comply with the requirements set forth in the Instruction to Bidders and General Conditions, within ten (10) business days of the date of the Notice of Acceptance of Bid and Intent to Award as issued by the County.
4. That the contract shall be awarded upon a resolution or minute order to that effect duly adopted by the governing body of County; and that execution of the Contract shall constitute a written memorial thereof.
5. To submit to the County such information as County may require determining whether a particular Bid is the lowest responsible bid submitted.
6. That the accompanying Bid Bond, certified check or cashier's check is in an amount not less than 10% of the total bid submitted and constitutes a guarantee that if awarded the contract, Contractor will execute the Contract and deliver the required bonds within ten (10) business days after notice of award. If Contractor fails to execute and deliver said documents, the bond or check is to be charged with the costs of the resultant damages to the County, including but not limited to: publication costs, the difference in money between the amount bid and the amount in excess of the bid which it costs County to do or cause to be done for the work involved, lease and rental costs, additional salaries and overhead, increased interest and costs of funding the project, attorney expense, additional engineering and architectural expense and cost of maintaining or constructing alternate facilities occasioned by the failure to execute and deliver said documents.
7. By signing this Bid the Contractor certifies that the representations made therein are made under penalty of perjury.

**Cajalco Road and Carroll Street  
Traffic Signal and Safety Lighting Project  
Community of Mead Valley  
Project No. D3-0115**

ISSUED BY ADDENDUM No. 3  
ATTACHMENT "A"

REVISED PROPOSAL

ITEM No.	ITEM CODE	ITEM	UNIT	ESTIMATED QUANTITY	ITEM PRICE (IN FIGURES)	TOTAL (IN FIGURES)
<b>BASE BID - Cajalco Road and Carroll Street Traffic Signal and Safety Lighting Project</b>						
1	066100	DUST ABATEMENT	LS	1	\$1,500	\$1,500
2	100100	DEVELOP WATER SUPPLY	LS	1	\$2,000	\$2,000
3	120100	TRAFFIC CONTROL SYSTEM	LS	1	\$30,399.00	\$30,399.00
4	130200	PREPARE WATER POLLUTION CONTROL PROGRAM	LS	1	\$2,500	\$2,500
5	015602	FUNDING AWARENESS SIGN	EA	1	\$3,000	\$3,000
6	820410	SALVAGE ROADSIDE SIGN	EA	1	174.00	174.00
7	820840	ROADSIDE SIGN - ONE POST	EA	6	\$609.00	\$3,654
8	840515	THERMOPLASTIC PAVEMENT MARKING	SQFT	54	\$7.25	\$391.50
9	846035	REMOVE THERMOPLASTIC PAVEMENT MARKING	SQFT	44	\$5.22	\$229.68
10	870400	SIGNAL AND LIGHTING SYSTEM	LS	1	\$244,700	\$244,700
11	010602	MISCELLANEOUS WORK (AS DIRECTED)	FA	1	25,000.00	25,000.00
12	730010	MINOR CONCRETE (CURB) [TYPE "D" 8" CURB (CRS 204)]	LF	30	\$232.00	\$6,960.00
13	730070	DETECTABLE WARNING SURFACE	SQFT	63	\$87.00	\$5,481.00
14	731521	MINOR CONCRETE (SIDEWALK)	CY	6	\$1,972.00	\$11,832.00
15	731850	REMOVE CONCRETE (CURB RAMP)	CY	3	\$1,276.00	\$3,828.00

PROJECT TOTAL: Three hundred forty-one thousand six hundred forty-nine dollars and eighteen cents. \$ 341,649.18  
ITEMS 1-15 "WORDS"

## Bidder Data and Signature

Name of Bidder: California Professional Engineering, Inc.

Type of organization: C Corp

Person(s) authorized to sign for Bidder: Van Nguyen

\_\_\_\_\_

\_\_\_\_\_

Note:

If Bidder is a **Corporation**, state legal name of Corporation and also names of the president, vice-president, secretary, treasurer and manager thereof.

If Bidder is a **Co-Partnership**, state true name of firm and also names of all individual co-partners composing firm.

If Bidder is a sole proprietorship or an **Individual**, state first and last name(s) in full.

If Bid is signed by an agent other than an owner, partner or corporate officer, Bid shall be accompanied by a power-of-attorney.

Business Street Address: 19062 San Jose Ave  
(Please include business address even if P.O. Box is used.)

Business City, State, Zip Code: La Puente CA 91748

P.O. Box- Number: \_\_\_\_\_

P.O. Box- City, State, Zip Code: \_\_\_\_\_

Phone: ( 626 ) 810 1338

Facsimile: ( \_\_\_\_\_ ) \_\_\_\_\_

E-mail: estimating@cpengineeringinc.com

Contractor's license number: 793907

License Classification(s): A, C10, C20

Expiration date: 4/30/27

Department of Industrial Relations Registration Number: 1000377609

**Bidder Data and Signature (continued)**

Accompanying this Bid is a certified check, cashier check or bid bond in an amount equal to at least ten (10) percent of the total bid for:

**Cajalco Road and Carroll Street  
Traffic Signal and Safety Lighting Project  
Community of Mead Valley  
Project No. D3-0115**

By my signature on this Bid, I certify, under penalty of perjury under the laws of the State of California, that all the information on this form is true and correct.

IN WITNESS WHERE OF Bidder/Contractor executed this Bid as of the date set forth on page B1 of this Bid.

**Signature:**

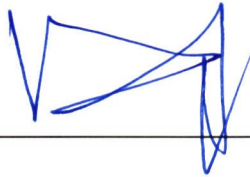

Name (printed):

Van Nguyen

Title:

President

“Contractor”

## Subcontractor List

Bidder/Contractor submits the following complete list of each Subcontractor who will perform work, labor or render service in or about the construction in an amount in excess of 1/2 of 1% of the total bid or \$10,000 whichever is greater.

Check box on right side of row if any construction item, for the listed Subcontractor, is partial work. If partial work is to be performed within a certain construction item or trade, the Bidder/Contractor shall specify the portion(s) of the work to be performed by the different subcontractors or Bidder/Contractor will be subject to provisions of Public Contract Code Section 4106.

Name of Bidder (Prime/General Contractor): California Professional Engineering, Inc.

	Subcontractor Name	License Number	DIR Registration Number	Business Address (City, State)	Construction Item(s) [Item Number and Description]	Check if Partial Work
1.	Superior Pavement Markings	#1141887	#2000015240	PO Box 278 Beaumont, CA 92223	#3 Partial #6-9	<input type="checkbox"/>
2.	Pavement Rehab	#1051374	1000064823	22711 E. La Palma Ave. Yorba Linda, CA 92887	#3 Partial, #12-15	<input type="checkbox"/>
3.						<input type="checkbox"/>
4.						<input type="checkbox"/>
5.						<input type="checkbox"/>
6.						<input type="checkbox"/>

Additional Subcontractor List(s) may be attached to the Bid.  
(A copy of this form may be attached with additional Subcontractor information.)

Percent of work to be performed by Subcontractors: 13<sup>vw</sup> 12 %

Note: A minimum of 50% of the work is required to be performed by the prime/general Contractor.

## Non-Collusion Declaration

To be executed by bidder and submitted with bid.  
(Title 23 United States Code Section 112 and Public Contract Code Section 7106)

The undersigned declares:

I am the President (Title) of California Professional Engineering Inc. (Company),  
the party making the foregoing bid.

The bid is not made in the interest of, or on behalf of, any undisclosed person, partnership, company, association, organization, or corporation. The bid is genuine and not collusive or sham. The bidder has not directly or indirectly induced or solicited any other bidder to put in a false or sham bid. The bidder has not directly or indirectly colluded, conspired, connived, or agreed with any bidder or anyone else to put in a sham bid, or that anyone shall refrain from bidding. The bidder has not in any manner, directly or indirectly, sought by agreement, communication, or conference with anyone to fix the bid price of the bidder or any other bidder, or to fix any overhead, profit, or cost element of the bid price, or of that of any other bidder.

All statements contained in the bid are true. The bidder has not, directly or indirectly, submitted his or her bid price of any breakdown thereof, or the contents thereof, or divulged information or data relative thereto, to any corporation, partnership, company, association, organization, bid depository, or to any member or agent thereof to effectuate a collusive or sham bid, and has not paid, and will not pay, any person or entity for such purpose.

Any person executing this declaration on behalf of a bidder that is a corporation, partnership, joint venture, limited liability company, limited liability partnership, or any other entity, hereby represents that he or she has full power to execute, and does execute, this declaration on behalf of the bidder.

I declare under penalty of perjury under the applicable laws that the foregoing is true and correct and that this declaration is executed on

November (Month) 12 (Day) of 2025 (Year),  
at La Puente (City), California (State).

**Signature of Declarant:** \_\_\_\_\_

**Printed name of Declarant:** \_\_\_\_\_

Van Nguyen

**Name of Bidder (Company):** \_\_\_\_\_

California Professional Engineering Inc.

**Title or Office:** \_\_\_\_\_

President

**Note:** Notarization of signature required.  
 Check box if attachment is included.

**CALIFORNIA ALL-PURPOSE ACKNOWLEDGMENT**

**CIVIL CODE § 1189**

A notary public or other officer completing this certificate verifies only the identity of the individual who signed the document to which this certificate is attached, and not the truthfulness, accuracy, or validity of that document.

State of California )

County of Los Angeles )

On 11/12/2025 before me, Alicia Nguyen,  
Date Here Insert Name and Title of the Officer

personally appeared Van Nguyen  
Name(s) of Signer(s)

who proved to me on the basis of satisfactory evidence to be the person(s) whose name(s) is/are subscribed to the within instrument and acknowledged to me that he/she/they executed the same in his/her/their authorized capacity(ies), and that by his/her/their signature(s) on the instrument the person(s), or the entity upon behalf of which the person(s) acted, executed the instrument.

I certify under PENALTY OF PERJURY under the laws of the State of California that the foregoing paragraph is true and correct.

WITNESS my hand and official seal.

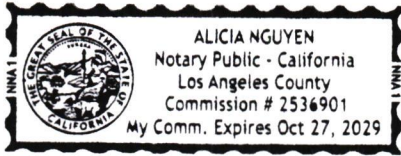

Signature [Handwritten Signature]  
Signature of Notary Public

Place Notary Seal Above

**OPTIONAL**

Though this section is optional, completing this information can deter alteration of the document or fraudulent reattachment of this form to an unintended document.

**Description of Attached Document**

Title or Type of Document: \_\_\_\_\_

Document Date: \_\_\_\_\_ Number of Pages: \_\_\_\_\_

Signer(s) Other Than Named Above: \_\_\_\_\_

**Capacity(ies) Claimed by Signer(s)**

Signer's Name: \_\_\_\_\_

Corporate Officer — Title(s): \_\_\_\_\_

Partner —  Limited  General

Individual  Attorney in Fact

Trustee  Guardian or Conservator

Other: \_\_\_\_\_

Signer Is Representing: \_\_\_\_\_

Signer's Name: \_\_\_\_\_

Corporate Officer — Title(s): \_\_\_\_\_

Partner —  Limited  General

Individual  Attorney in Fact

Trustee  Guardian or Conservator

Other: \_\_\_\_\_

Signer Is Representing: \_\_\_\_\_

**Iran Contracting Act**  
(Public Contract Code sections 2200-2208)

Prior to bidding on, submitting a proposal or executing a contract or renewal for a County of Riverside contract for goods or services of **\$1,000,000 or more**, a Contractor must either:

- a) Certify it is not on the current list of persons engaged in investment activities in Iran created by the California Department of General Services (“DGS”) pursuant to Public Contract Code section 2203(b) and is not a financial institution extending twenty million dollars (\$20,000,000) or more in credit to another person, for 45 days or more, if that other person will use the credit to provide goods or services in the energy sector in Iran and is identified on the current list of persons engaged in investment activities in Iran created by DGS; or
- b) Demonstrate it has been exempted from the certification requirement for that solicitation or contract pursuant to Public Contract Code section 2203(c) or (d).

To comply with this requirement, please insert your Contractor or financial institution name and Federal ID Number (if available) and complete one of the options below. Please note: California law establishes penalties for providing false certifications, including civil penalties equal to the greater of \$250,000 or twice the amount of the contract for which the false certification was made; contract termination; and three-year ineligibility to bid on contracts. (Public Contract Code section 2205.)

**Option #1 – Certification**

I, the official named below, certify I am duly authorized to execute this certification on behalf of the vendor/financial institution identified below, and the vendor/financial institution identified below is **not** on the current list of persons engaged in investment activities in Iran created by DGS and is not a financial institution extending twenty million dollars (\$20,000,000) or more in credit to another person/vendor, for 45 days or more, if that other person/vendor will use the credit to provide goods or services in the energy sector in Iran and is identified on the current list of persons engaged in investment activities in Iran created by DGS.

<i>Contractor Name/Financial Institution (Printed)</i> <b>California Professional Engineering, Inc.</b>		<i>Federal ID Number (or n/a)</i> <b>95-4837794</b>
<i>By (Authorized Signature)</i> 		
<i>Printed Name and Title of Person Signing</i> <b>Van Nguyen , President</b>		
<i>Date Executed</i> <b>11/12/2025</b>	<i>Executed in</i> <b>La Puente, CA</b>	

**Option #2 – Exemption**

Pursuant to Public Contract Code sections 2203(c) and (d), a public entity may permit a Contractor/financial institution engaged in investment activities in Iran, on a case-by-case basis, to be eligible for, or to bid on, submit a proposal for, or enters into or renews, a contract for goods and services.

**If you have obtained an exemption** from the certification requirement under the Iran Contracting Act, please fill out the information below, and **attach documentation demonstrating the exemption approval.**

<i>Contractor Name/Financial Institution (Printed)</i>		<i>Federal ID Number (or n/a)</i>
<i>By (Authorized Signature)</i>		
<i>Printed Name and Title of Person Signing</i>		
<i>Date Executed</i>	<i>Executed in</i>	

**Bid Bond**

**COPY**

ial Engineering, Inc. "Contractor", has Contractor's Proposal to County of Riverside, "County", for the construction of alco Road and Carroll Street, Traffic Signal and Safety Lighting Project, Valley, Project No. D3-0115 in accordance with a Notice Inviting Bids from the

2. Endurance Assurance Corporation a Delaware corporation, hereafter called "Surety", is the surety of this bond.

**Agreement:**

We, Contractor as Principal and Surety as Surety, jointly and severally agree and state as follows:

1. The amount of the obligation of this bond is 10% of the amount of the Contractor's Proposal, including bid alternates, and inures to the benefit of County.
2. This Bond is exonerated by (1) County rejecting said Proposal or, in the alternate, (2) if said Proposal is accepted, Contractor executes the Contract and furnishes the Bonds as agreed to in its Proposal, otherwise it remains in full force and effect for the recovery of loss, damage and expense of County resulting from failure of Contractor to act as agreed to in its Proposal. Some types of possible loss, damage and expense are specified in the Contractor's Proposal.
3. Surety, for value received, stipulates and agrees that its obligations hereunder shall in no way be impaired or affected by any extension of time within which County may accept the Proposal and waives notice of any such extension.
4. This Bond is binding on our heirs, executors, administrators, successors and assigns.

Dated: November 7, 2025

Signatures:

Endurance Assurance Corporation

California Professional Engineering, Inc.

By: Christine Woolford, Attorney-in-Fact

By: Van Nguyen

Title: Attorney in Fact "Surety"

Title: President "Contractor"

STATE OF \_\_\_\_\_  
COUNTY \_\_\_\_\_  
OF \_\_\_\_\_

} ss. SURETY'S ACKNOWLEDGEMENT

On \_\_\_\_\_ before me, \_\_\_\_\_ personally appeared, \_\_\_\_\_ known to me, or proved to me on the basis of satisfactory evidence, to be the person whose name is subscribed to the within instrument and acknowledged to me that he/she executed the same in his/her authorized capacities, and that by his/her signature on the instrument the person, or the entity upon behalf of which the person acted, executed the instrument.

WITNESS my hand and official seal.

\_\_\_\_\_  
Signature of Notary Public

\_\_\_\_\_  
Notary Public (Seal)

**Note: This Bond must be executed by both Contractor and Surety with corporate seal affixed. All signatures must be notarized. (Attach acknowledgements).**

**CALIFORNIA ALL-PURPOSE ACKNOWLEDGMENT**

**CIVIL CODE § 1189**

A notary public or other officer completing this certificate verifies only the identity of the individual who signed the document to which this certificate is attached, and not the truthfulness, accuracy, or validity of that document.

State of California )  
County of Los Angeles )

On 11/12/2025 before me, Alicia Nguyen,  
*Date Here Insert Name and Title of the Officer*  
personally appeared Van Nguyen  
*Name(s) of Signer(s)*

who proved to me on the basis of satisfactory evidence to be the person(s) whose name(s) is/are subscribed to the within instrument and acknowledged to me that he/she/they executed the same in his/her/their authorized capacity(ies), and that by his/her/their signature(s) on the instrument the person(s), or the entity upon behalf of which the person(s) acted, executed the instrument.

I certify under PENALTY OF PERJURY under the laws of the State of California that the foregoing paragraph is true and correct.

WITNESS my hand and official seal.

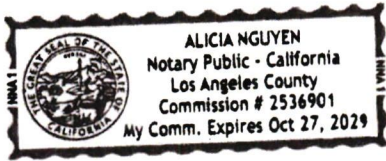

Signature [Handwritten Signature]  
*Signature of Notary Public*

*Place Notary Seal Above*

**OPTIONAL**

*Though this section is optional, completing this information can deter alteration of the document or fraudulent reattachment of this form to an unintended document.*

**Description of Attached Document**

Title or Type of Document: \_\_\_\_\_  
Document Date: \_\_\_\_\_ Number of Pages: \_\_\_\_\_  
Signer(s) Other Than Named Above: \_\_\_\_\_

**Capacity(ies) Claimed by Signer(s)**

Signer's Name: \_\_\_\_\_  
 Corporate Officer — Title(s): \_\_\_\_\_  
 Partner —  Limited  General  
 Individual  Attorney in Fact  
 Trustee  Guardian or Conservator  
 Other: \_\_\_\_\_  
Signer Is Representing: \_\_\_\_\_

Signer's Name: \_\_\_\_\_  
 Corporate Officer — Title(s): \_\_\_\_\_  
 Partner —  Limited  General  
 Individual  Attorney in Fact  
 Trustee  Guardian or Conservator  
 Other: \_\_\_\_\_  
Signer Is Representing: \_\_\_\_\_

# CALIFORNIA ALL-PURPOSE ACKNOWLEDGMENT

A notary public or other officer completing this certificate verifies only the identity of the individual who signed the document to which this certificate is attached, and not the truthfulness, accuracy, or validity of that document.

STATE OF CALIFORNIA

County of Orange }

On NOV 07 2025 before me, Thao Nguyen Luu, Notary Public,  
Date Insert Name of Notary exactly as it appears on the official seal

personally appeared Christine Woolford  
Name(s) of Signer(s)

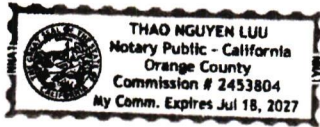

who proved to me on the basis of satisfactory evidence to be the person(s) whose name(s) is/are subscribed to the within instrument and acknowledged to me that he/she/they executed the same in his/her/their authorized capacity(ies), and that by his/her/their signature(s) on the instrument the person(s), or the entity upon behalf of which the person(s) acted, executed the instrument.

I certify under PENALTY OF PERJURY under the laws of the State of California that the foregoing paragraph is true and correct.

Witness my hand and official seal.

Signature [Handwritten Signature]  
Signature of Notary Public

Place Notary Seal Above

## OPTIONAL

Though the information below is not required by law, it may prove valuable to persons relying on the document and could prevent fraudulent removal and reattachment of the form to another document.

### Description of Attached Document

Title or Type of Document: \_\_\_\_\_

Document Date: \_\_\_\_\_ Number of Pages: \_\_\_\_\_

Signer(s) Other Than Named Above: \_\_\_\_\_

### Capacity(ies) Claimed by Signer(s)

Signer's Name: \_\_\_\_\_

- Individual
- Corporate Officer — Title(s): \_\_\_\_\_
- Partner  Limited  General
- Attorney in Fact
- Trustee
- Guardian or Conservator
- Other: \_\_\_\_\_



Signer is Representing: \_\_\_\_\_  
\_\_\_\_\_  
\_\_\_\_\_

Signer's Name: \_\_\_\_\_

- Individual
- Corporate Officer — Title(s): \_\_\_\_\_
- Partner  Limited  General
- Attorney in Fact
- Trustee
- Guardian or Conservator
- Other: \_\_\_\_\_



Signer is Representing: \_\_\_\_\_  
\_\_\_\_\_  
\_\_\_\_\_

KNOW ALL BY THESE PRESENTS, that **Endurance Assurance Corporation**, a Delaware corporation ("EAC"), **Endurance American Insurance Company**, a Delaware corporation ("EAIC"), **Lexon Insurance Company**, a Texas corporation ("LIC"), and/or **Bond Safeguard Insurance Company**, a South Dakota corporation ("BSIC"), each, a "Company" and collectively, "**Sompo International**," do hereby constitute and appoint: **Yung T. Mullick, James W. Moilanen, Irene Luong, P. Austin Neff, Emilie George, Christine Woolford, Danielle Hanson** as true and lawful Attorney(s)-In-Fact to make, execute, seal, and deliver for, and on its behalf as surety or co-surety; bonds and undertakings given for any and all purposes, also to execute and deliver on its behalf as aforesaid renewals, extensions, agreements, waivers, consents or stipulations relating to such bonds or undertakings provided, however, that no single bond or undertaking so made, executed and delivered shall obligate the Company for any portion of the penal sum thereof in excess of the sum of **One Hundred Million Dollars (\$100,000,000.00)**.

Said bonds and undertakings for said purposes, when duly executed by said attorney(s)-in-fact, shall be binding upon the Company as fully and to the same extent as if signed by the President of the Company under its corporate seal attested by its Corporate Secretary.

This appointment is made under and by authority of certain resolutions adopted by the board of directors of each Company by unanimous written consent effective the 30<sup>th</sup> day of March, 2023 for BSIC and LIC and the 17<sup>th</sup> day of May, 2023 for EAC and EAIC, a copy of which appears below under the heading entitled "Certificate".

This Power of Attorney is signed and sealed by facsimile under and by authority of the following resolution adopted by the board of directors of each Company by unanimous written consent effective the 30<sup>th</sup> day of March, 2023 for BSIC and LIC and the 17<sup>th</sup> day of May, 2023 for EAC and EAIC and said resolution has not since been revoked, amended or repealed:

RESOLVED, that the signature of an individual named above and the seal of the Company may be affixed to any such power of attorney or any certificate relating thereto by facsimile, and any such power of attorney or certificate bearing such facsimile signature or seal shall be valid and binding upon the Company in the future with respect to any bond or undertaking to which it is attached.

IN WITNESS WHEREOF, each Company has caused this instrument to be signed by the following officers, and its corporate seal to be affixed this 25th day of May, 2023.

**Endurance Assurance Corporation**  
By: *Richard M Appel*  
Richard Appel, SVP & Senior Counsel



**Endurance American Insurance Company**  
By: *Richard M Appel*  
Richard Appel, SVP & Senior Counsel



**Lexon Insurance Company**  
By: *Richard M Appel*  
Richard Appel, SVP & Senior Counsel



**Bond Safeguard Insurance Company**  
By: *Richard M Appel*  
Richard Appel, SVP & Senior Counsel



**ACKNOWLEDGEMENT**

On this 25th day of May, 2023, before me, personally came the above signatories known to me, who being duly sworn, did depose and say that he/she is an officer of each of the Companies; and that he executed said instrument on behalf of each Company by authority of his office under the by-laws of each Company.

By: *Amy Taylor*  
Amy Taylor, Notary Public - My Commission Expires 3/9/27



**CERTIFICATE**

I, the undersigned Officer of each Company, DO HEREBY CERTIFY that:

1. That the original power of attorney of which the foregoing is a copy was duly executed on behalf of each Company and has not since been revoked, amended or modified; that the undersigned has compared the foregoing copy thereof with the original power of attorney, and that the same is a true and correct copy of the original power of attorney and of the whole thereof;
2. The following are resolutions which were adopted by the board of directors of each Company by unanimous written consent effective 30<sup>th</sup> day of March, 2023 for BSIC and LIC and the 17<sup>th</sup> day of May, 2023 for EAC and EAIC and said resolutions have not since been revoked, amended or modified:

"RESOLVED, that each of the individuals named below is authorized to make, execute, seal and deliver for and on behalf of the Company any and all bonds, undertakings or obligations in surety or co-surety with others: RICHARD M. APPEL, MATTHEW E. CURRAN, MARGARET HYLAND, SHARON L. SIMS, CHRISTOPHER L. SPARRO, and be it further

RESOLVED, that each of the individuals named above is authorized to appoint attorneys-in-fact for the purpose of making, executing, sealing and delivering bonds, undertakings or obligations in surety or co-surety for and on behalf of the Company."

3. The undersigned further certifies that the above resolutions are true and correct copies of the resolutions as so recorded and of the whole thereof.

IN WITNESS WHEREOF, I have hereunto set my hand and affixed the corporate seal this 7th day of November, 2025.

By: *Daniel S. Lurie*  
Daniel S. Lurie, Secretary

**NOTICE: U. S. TREASURY DEPARTMENT'S OFFICE OF FOREIGN ASSETS CONTROL (OFAC)**

No coverage is provided by this Notice nor can it be construed to replace any provisions of any surety bond or other surety coverage provided. This Notice provides information concerning possible impact on your surety coverage due to directives issued by OFAC. **Please read this Notice carefully.**

The Office of Foreign Assets Control (OFAC) administers and enforces sanctions policy, based on Presidential declarations of "national emergency". OFAC has identified and listed numerous foreign agents, front organizations, terrorists, terrorist organizations, and narcotics traffickers as "Specially Designated Nationals and Blocked Persons". This list can be located on the United States Treasury's website - <https://www.treasury.gov/resource-center/sanctions/SDN-List>.

In accordance with OFAC regulations, if it is determined that you or any other person or entity claiming the benefits of any coverage has violated U.S. sanctions law or is a Specially Designated National and Blocked Person, as identified by OFAC, any coverage will be considered a blocked or frozen contract and all provisions of any coverage provided are immediately subject to OFAC. When a surety bond or other form of surety coverage is considered to be such a blocked or frozen contract, no payments nor premium refunds may be made without authorization from OFAC. Other limitations on the premiums and payments may also apply.

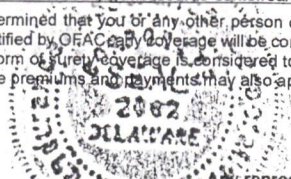

Any reproductions are void.

Surety Claims Submission: [LexonClaimAdministration@sompo-intl.com](mailto:LexonClaimAdministration@sompo-intl.com)

Telephone: 615-553-9500 Mailing Address: Sompo International; 12890 Lebanon Road; Mount Juliet, TN 37122-2870

- Company Profile
- Company Search
- Company Search Results
- Company Information
- Old Company Names
- Agent for Service
- Reference Information
- NAIC Group List
- Lines of Business
- Workers' Compensation
- Complaint and Request for Action/Appeals
- Contact Information

**COMPANY PROFILE**
**Company Information**

**ENDURANCE ASSURANCE CORPORATION**  
**4 MANHATTANVILLE ROAD, 3RD FLOOR**  
**NEW YORK, NY 10577**

Old Company Names	Effective Date
ENDURANCE REINSURANCE COMPANY OF AMERICA	01/30/2008
ENDURANCE REINSURANCE CORPORATION OF AMERICA	08/23/2016
ENDURANCE REINSURANCE CORPORATION OF AMERICA DBA	
ENDURANCE WORKERS' COMPENSATION INSURANCE COMPANY	12/30/2009

**Agent For Service**

AMANDA GARCIA  
 330 N Brand Blvd Ste 700  
 Glendale CA 91203

**Financial Statements PDF's**

- Annual Statements
- Quarterly Statements
- Company Complaint
- Company Performance & Comparison Data
- Company Enforcement Action
- Composite Complaints Studies

**Reference Information**

NAIC #:	11551
California Company ID #:	5082-3
Date Authorized in California:	01/30/2008
License Status:	UNLIMITED-NORMAL
Company Type:	Property & Casualty
State of Domicile:	DELAWARE

**Additional Info**

- Find A Company Representative In Your Area
- View Financial Disclaimer

[back to top](#)
**NAIC Group List**

NAIC Group #: [3219](#) Sompo Grp

**Lines Of Business**

The company is authorized to transact business within these lines of insurance. For an explanation of any of these terms, please refer to the [glossary](#).

AIRCRAFT  
 AUTOMOBILE  
 BOILER AND MACHINERY  
 BURGLARY  
 COMMON CARRIER LIABILITY  
 CREDIT  
 DISABILITY  
 FIRE  
 LEGAL INSURANCE  
 LIABILITY  
 MARINE  
 MISCELLANEOUS  
 PLATE GLASS  
 SPRINKLER  
 SURETY  
 TEAM AND VEHICLE  
 WORKERS' COMPENSATION

[back to top](#)



*Dennis Acuna, P. E., T. E.*  
*Director of Transportation*

# COUNTY OF RIVERSIDE

## TRANSPORTATION AND LAND MANAGEMENT AGENCY

*Hector D. Davila, P.E.*  
*Deputy for Transportation/  
Capital Projects*

*Russell Williams*  
*Deputy for Transportation/  
Planning and Development*

### Transportation Department

#### ADDENDUM NUMBER 1

**Dated November 5, 2025**

to the  
**Specifications and Contract Documents  
for the construction of**

**Cajalco Road and Carroll Street  
Traffic Signal and Safety Lighting Project  
Community of Mead Valley  
Project No. D3-0115**

**Bids Due: Wednesday, November 12, 2025; 2:00 p.m.**  
14<sup>th</sup> Street Transportation Annex  
3525 14<sup>th</sup> Street; Riverside, CA 92501  
(951) 955-6780

This Addendum is issued pursuant to the Instructions to Bidders, Item No. 8, of the Contract Documents for the reference project. This Addendum is issued as a supplement to the specification and special provisions for the referenced project. The revisions to the specifications shall become a part of the Contract Documents, and each bidder shall acknowledge receipt thereof on the Bid (Proposal). Bidders are directed to sign this addendum as acknowledged and attach the signed addendum to the contractor's submitted proposal.

Note: During the advertisement period of this project, this document and attachments (if any) are available upon request at the office of the Transportation Department, and are available as a free download at the Transportation Department's website:

<https://trans.rctlma.org/notices-inviting-bids>

#### MODIFICATIONS/ CLARIFICATIONS TO SPECIAL PROVISIONS:

**Item 1: Revised Proposal**

Refer to "Proposal" page B2. Delete and replace "Proposal" (page B2) with "Proposal (Revised)" attached herewith as **Attachment "A"**.

**Note: Revisions made to the proposal by Addendum No. 1 are written with blue font/numbers in Attachment "A".**

a. Force Account fixed amount has been added for the following bid item:

Item 11, MISCELLANEOUS WORK (AS DIRECTED)

#### **ATTACHMENTS:**

**A – Revised Proposal (1 page)**

Addendum No. 1

Cajalco Road and Carroll Street Traffic Signal and Safety Lighting Project

Community of Mead Valley

Project No. D3-0115

November 5, 2025

Page 2 of 2

---

**Prepared by:** \_\_\_\_\_



Joel Jimenez  
Engineering Project Manager  
Contracts/Bidding Unit

**Date:** November 5, 2025

**Acknowledged:** \_\_\_\_\_

(Contractor)

**Date:** \_\_\_\_\_

JRJ:jrj:rr

Note: Refer to Instruction to Bidders Item No. 8, "Addenda". Submission of all addendum pages and non-bidding document attachments of addendum are not necessary for Bid submittal. Submittal of this acknowledgement page is adequate for Bid reception. Bidders are reminded to list addendum number(s) received on the first page of the Bid form (Proposal).

**Cajalco Road and Carroll Street  
Traffic Signal and Safety Lighting Project  
Community of Mead Valley  
Project No. D3-0115**

ISSUED BY ADDENDUM No. 1  
ATTACHMENT "A"

**REVISED PROPOSAL**

ITEM No.	ITEM CODE	ITEM	UNIT	ESTIMATED QUANTITY	ITEM PRICE (IN FIGURES)	TOTAL (IN FIGURES)
<b>BASE BID - Cajalco Road and Carroll Street Traffic Signal and Safety Lighting Project</b>						
1	066100	DUST ABATEMENT	LS	1		
2	100100	DEVELOP WATER SUPPLY	LS	1		
3	120100	TRAFFIC CONTROL SYSTEM	LS	1		
4	130200	PREPARE WATER POLLUTION CONTROL PROGRAM	LS	1		
5	015602	FUNDING AWARENESS SIGN	EA	1		
6	820410	SALVAGE ROADSIDE SIGN	EA	1		
7	820840	ROADSIDE SIGN - ONE POST	EA	6		
8	840515	THERMOPLASTIC PAVEMENT MARKING	SQFT	54		
9	846035	REMOVE THERMOPLASTIC PAVEMENT MARKING	SQFT	44		
10	870400	SIGNAL AND LIGHTING SYSTEM	LS	1		
11	010602	MISCELLANEOUS WORK (AS DIRECTED)	FA	1	<b>25,000.00</b>	<b>25,000.00</b>

PROJECT  
TOTAL:  
ITEMS 1-11

"WORDS"

\$ \_\_\_\_\_



COUNTY OF RIVERSIDE
TRANSPORTATION AND
LAND MANAGEMENT AGENCY

Dennis Acuna, P. E., T. E.
Director of Transportation

Hector D. Davila, P.E.
Deputy for Transportation/
Capital Projects

Russell Williams
Deputy for Transportation/
Planning and Development

Transportation Department

ADDENDUM NUMBER 2

Dated November 12, 2025

to the
Specifications and Contract Documents
for the construction of

Cajalco Road and Carroll Street
Traffic Signal and Safety Lighting Project
Community of Mead Valley
Project No. D3-0115

Bids Due: (Revised)
Wednesday, November 19, 2025; 2:00 p.m.
14th Street Transportation Annex
3525 14th Street; Riverside, CA 92501
(951) 955-6780

This Addendum is issued pursuant to the Instructions to Bidders, Item No. 8, of the Contract Documents for the reference project. This Addendum is issued as a supplement to the specification and special provisions for the referenced project. The revisions to the specifications shall become a part of the Contract Documents, and each bidder shall acknowledge receipt thereof on the Bid (Proposal). Bidders are directed to sign this addendum as acknowledged and attach the signed addendum to the contractor's submitted proposal.

Note: During the advertisement period of this project, this document and attachments (if any) are available upon request at the office of the Transportation Department, and are available as a free download at the Transportation Department's website:

https://trans.rctlma.org/notices-inviting-bids

MODIFICATIONS / CLARIFICATIONS TO SPECIAL PROVISIONS:

Item 1: The new designated date and time for the receipt and opening of bids is revised as follows:

Wednesday, November 19, 2025; 2:00 p.m.
14th Street Transportation Annex
3525 14th Street; Riverside, CA 92501
(951) 955-6780

Prepared by: [Signature] Date: November 12, 2025
Joel Jimenez, Project Manager, Contracts/Bidding Unit

Acknowledged: \_\_\_\_\_ Date: \_\_\_\_\_
(Contractor)

JRJ:jjr:rr



*Dennis Acuna, P. E., T. E.*  
*Director of Transportation*

# COUNTY OF RIVERSIDE

## TRANSPORTATION AND LAND MANAGEMENT AGENCY

*Hector D. Davila, P.E.*  
*Deputy for Transportation/  
Capital Projects*

*Russell Williams*  
*Deputy for Transportation/  
Planning and Development*

### Transportation Department

#### ADDENDUM NUMBER 3

November 18, 2025

to the  
Specifications and Contract Documents  
for the construction of

Cajalco Road and Carroll Street  
Traffic Signal and Safety Lighting Project  
Community of Mead Valley  
Project No. D3-0115

**Bids Due: (Revised)**  
**Wednesday, November 26, 2025; 2:00 p.m.**  
14<sup>th</sup> Street Transportation Annex  
3525 14<sup>th</sup> Street; Riverside, CA 92501  
(951) 955-6780

This Addendum is issued pursuant to the Instructions to Bidders, Item No. 8, of the Contract Documents for the reference project. This Addendum is issued as a supplement to the specification and special provisions for the referenced project. The revisions to the specifications shall become a part of the Contract Documents, and each bidder shall acknowledge receipt thereof on the Bid (Proposal). Bidders are directed to sign this addendum as acknowledged and attach the signed addendum to the contractor's submitted proposal.

Note: During the advertisement period of this project, this document and attachments (if any) are available upon request at the office of the Transportation Department, and are available as a free download at the Transportation Department's website:

<https://trans.rctlma.org/notices-inviting-bids>

#### MODIFICATIONS / CLARIFICATIONS TO SPECIAL PROVISIONS:

**Item 1:** The new designated date and time for the receipt and opening of bids is revised as follows:

**Wednesday, November 26, 2025; 2:00 p.m.**  
**14<sup>th</sup> Street Transportation Annex**  
**3525 14<sup>th</sup> Street; Riverside, CA 92501**  
**(951) 955-6780**

**Item 2: Revised Proposal**

Refer to "Revised Proposal" as issued by Addendum No. 1. Delete and replace "Revised Proposal" as issued by Addendum No. 1 with "Revised Proposal" attached herewith as **Attachment "A"**. The following changes have been made to the Proposal:

**Note: Revisions made to the proposal are written with blue font and blue numbers in Attachment "A".**

a. The following bid items have been added:

Item 12, MINOR CONCRETE (CURB) [TYPE "D" 8" CURB (CRS 204)]

Item 13, DETECTABLE WARNING SURFACE

Item 14, MINOR CONCRETE (SIDEWALK)

Item 15, REMOVE CONCRETE (CURB RAMP)

**Item 3: Concrete Curbs and Sidewalks, Detectable Warning Surface (Truncated Domes)**

The following provisions are added and are made a part hereby:

**DIVISION VIII MISCELLANEOUS CONSTRUCTION**

**73 CONCRETE CURBS AND SIDEWALKS**

**Add to Section 73-1.01 General:**

**73-1.01 GENERAL**

Concrete Items to be constructed are:

- Sidewalk per County Std 401 and as shown on the plans.
- Type D Curb per County Std 204 and as shown on the plans.

These minor concrete items shall be constructed in accordance with the plans, the County Road Improvement Standards and Specifications, as directed by the Engineer, and in conformance with the applicable provisions in Section 73 and 90 of Standard Specifications, except as modified.

The cementitious material content of concrete must be at least 505 pounds per cubic yard for:

Sidewalk and Type "D" Curb

**73-1.03 CONSTRUCTION**

**Add to Section 73-1.03 Construction:**

Preparation of subgrade for the concrete structures shall be done in conformance with the requirements of Section 73-1.03B Subgrade Preparation of the Standard Specifications.

Excess material resulting from the excavation of the subgrade shall be disposed of as provided in Section 00-1.14, 'Disposal of Excess Excavation or Materials', of these Special Provisions.

Except for existing Concrete Ramp located on the east side of Carroll Street, full compensation for the removal of existing concrete items (Concrete Paving / Concrete Island, and Curb) as shown on the plans; including concrete sawcutting, removal and proper disposal of portions of existing concrete paving / concrete island, existing concrete curb, grinding existing curb cut flush with gutter flowline; shall be considered as included in the contract bid prices paid per linear foot for Minor Concrete (Curb) [Type "D", 8" Curb (CRS 204)], and per square foot for Minor Concrete (Sidewalk).

Full compensation for the removal of existing Concrete Ramp located on the east side of Carroll Street; including removal and proper disposal of concrete ramp and adjacent sidewalk segments as shown on the plans, scarifying down 0.5' minimum, moisture condition, grading and compaction of underlying material, and backfilling with Class II Aggregate Base shall be considered as included in the contract bid price paid per cubic yard for Remove Concrete (Curb Ramp).

The Contractor is responsible for meeting requirements of American with Disabilities Act (ADA), the current edition of the California Building Code, and the draft and final versions of the Accessibility

Guidelines for Pedestrian Facilities within the Public Right of Way as published by the United States Access Board.

Construction of minor concrete items shall include, but not be limited to, the following:

- 1) Removal and disposal of existing minor concrete items and existing soil and aggregate as required;
- 2) Establishing grades, and assuring that all grades are met;
- 3) Performing all moisture conditioning, grading and compaction of subgrade – including all required aggregate import, as directed by the Engineer and in accordance with County Standards;
- 4) Construction of new minor concrete items;
- 5) All scoring/grooving and required saw cutting;
- 6) If needed, repair of existing asphalt and PCC surfacing adjacent to minor concrete items, including slot cuts in front or around Minor Concrete items;
  - Surface repairs shall consist of replacing HMA over aggregate base in kind to match existing roadway structural section or as shown on the plans.
  - Alternatively, if approved by the Engineer, surface repairs can be 2-sack slurry cement backfill then cap with HMA, or a deep lift of HMA.
- 7) Installing 1/2" wide expansion joints;
- 8) All landscaping, and related work, to return the area adjacent to the minor concrete items to its original condition and to conform the area to the new improvements;

#### **DETECTABLE WARNING SURFACES (TRUNCATED DOMES)**

This work includes installing detectable warning surface on the curb ramps and on other areas requiring installation of detectable warning surface as shown on the plans, standard plans, and as specified in these Special Provisions, and as directed by the Engineer.

Detectable warning surface must be:

1. Yellow color complying with Federal Standard 595B, Color No. 33538.
2. Raised truncated domes.

The manufacturer must provide a written 5-year warranty for detectable warning surface, guaranteeing replacement when there is defect in the dome shape, color fastness, sound-on-cane acoustic quality, resilience, or attachment. The warranty period will begin upon acceptance of the contract.

Installation of detectable warning surface must comply with the manufacturer's recommendations.

#### **Payment**

Full compensation for Truncated Domes shall be considered as included in the contract unit price paid per square foot for Detectable Warning Surface (Truncated Domes), and shall include full compensation for furnishing all labor, materials, tools, equipment and incidentals for doing all work involved in constructing detectable warning surface, complete in place, as shown on the plans, as specified in these Special Provisions, and as directed by the Engineer, and no separate payment will be made therefor.

#### **Replace Section 73-1.04 Payment:**

#### **Payment**

The contract unit bid prices paid per linear foot for:

- Minor Concrete (Curb) [Type "D" 8" Curb (CRS 204)], and

per cubic yard for:

- Minor Concrete (Sidewalk);

shall include full compensation for furnishing all labor, equipment, materials and tools, and incidentals, and for doing all the work involved in the concrete structures construction including the grading and the removal of any obstacles within the areas of proposed concrete items of work including excavation, backfill, the furnishing and placing of expansion joints, complete in place as shown on the plans, as specified in the Standard Specifications and these Special Provisions, and as directed by the Engineer and no additional compensation will be allowed therefor.

**Item 4: Remove Traffic Stripes and Pavement Markings**

Refer to Section 84-9.03B, Remove Traffic Stripes and Pavement Markings, on page 30 of the Special Provisions.

Delete the 4th paragraph in Section 84-9.03B, and replace it with the following paragraph:

- B. Grinding: A minimum of 3 passes with the grinder in a rectangular area rather than just lettering or markings so the old message cannot be identified is required. Removal shall be to a maximum depth of 1/10". Removal depth may exceed 1/10" only when necessary to effectively remove paint, and only on approval by the Engineer. Asphalt emulsion shall be applied to the areas where stripes or pavement markings have been removed.

Delete the 6th paragraph in Section 84-9.03B, and replace it with the following paragraph:

After removal of traffic stripes and pavement markings, an asphalt emulsion coat shall be applied in conformance with the applicable provisions for asphalt emulsion found in Section 37, "Bituminous Seals" of the Standard Specifications.

**Item 5: Clarification, Archaeological Resources Monitoring**

Refer to Section 14-2.03, Archaeological Resources, on page 24 of the Special Provisions.

Section 14-2.03 applies only if cultural resources are discovered at the job site during excavations. Although not anticipated, if necessary, monitoring for Archaeological Resources will be provided by County.

**MODIFICATIONS / CLARIFICATIONS TO THE PLANS:**

**Item 6: Plan sheet revisions.**

Refer to plan sheets for Cajalco Road and Carroll Street Traffic Signal and Safety Lighting Project. The following plan sheet is revised and issued hereby as **Attachment "B"**.

**Partial summary notes of changes:** The following is a summary of plan sheet revision notes.

1. Sheet 4 of 4, Demolition and Construction Notes revised, Truncated Domes detail added.

**Note:** Revised plan sheet is posted on the County website and available for download during the advertisement period.

<https://trans.rctlma.org/notices-inviting-bids>

**Item 7: Traffic Signal Note No. 17.**

Refer to Traffic Signal notes on Sheet 1 of 4 of the plans for Cajalco Road and Carroll Street Traffic Signal and Safety Lighting Project. Traffic Signal Note No. 17 is deleted hereby.

Clarification, for this project, timing sheets will be provided by the County.

**ATTACHMENTS**

**A – Revised Proposal (1 page)**

**B – Revised Plans (1 sheet)**

This addendum has been prepared under the direction of the following registered Civil Engineer(s):

**Recommended by:**



Susan Vombaur, PE  
Engineering Project Manager

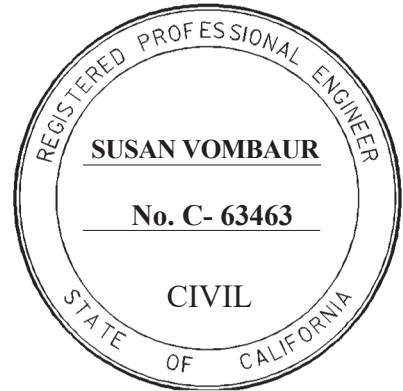

**Concurrence:**



Susan Vombaur, PE  
Engineering Division Manager

**Acknowledged:** \_\_\_\_\_ **Date:** \_\_\_\_\_  
(Contractor)

JRJ: jrj:jr

Note: Refer to Instruction to Bidders Item No. 8, "Addenda". Submission of all addendum pages and non-bidding document attachments of addendum are not necessary for Bid submittal. Submittal of this acknowledgement page is adequate for Bid reception. Bidders are reminded to list addendum number(s) received on the first page of the Bid form (Proposal).

**Cajalco Road and Carroll Street  
Traffic Signal and Safety Lighting Project  
Community of Mead Valley  
Project No. D3-0115**

ISSUED BY ADDENDUM No. 3  
ATTACHMENT "A"

**REVISED PROPOSAL**

ITEM No.	ITEM CODE	ITEM	UNIT	ESTIMATED QUANTITY	ITEM PRICE (IN FIGURES)	TOTAL (IN FIGURES)
<b>BASE BID - Cajalco Road and Carroll Street Traffic Signal and Safety Lighting Project</b>						
1	066100	DUST ABATEMENT	LS	1		
2	100100	DEVELOP WATER SUPPLY	LS	1		
3	120100	TRAFFIC CONTROL SYSTEM	LS	1		
4	130200	PREPARE WATER POLLUTION CONTROL PROGRAM	LS	1		
5	015602	FUNDING AWARENESS SIGN	EA	1		
6	820410	SALVAGE ROADSIDE SIGN	EA	1		
7	820840	ROADSIDE SIGN - ONE POST	EA	6		
8	840515	THERMOPLASTIC PAVEMENT MARKING	SQFT	54		
9	846035	REMOVE THERMOPLASTIC PAVEMENT MARKING	SQFT	44		
10	870400	SIGNAL AND LIGHTING SYSTEM	LS	1		
11	010602	MISCELLANEOUS WORK (AS DIRECTED)	FA	1	<b>25,000.00</b>	<b>25,000.00</b>
12	730010	MINOR CONCRETE (CURB) [TYPE "D" 8" CURB (CRS 204)]	LF	30		
13	730070	DETECTABLE WARNING SURFACE	SQFT	63		
14	731521	MINOR CONCRETE (SIDEWALK)	CY	6		
15	731850	REMOVE CONCRETE (CURB RAMP)	CY	3		

PROJECT TOTAL: \_\_\_\_\_ \$ \_\_\_\_\_  
ITEMS 1-15 "WORDS"

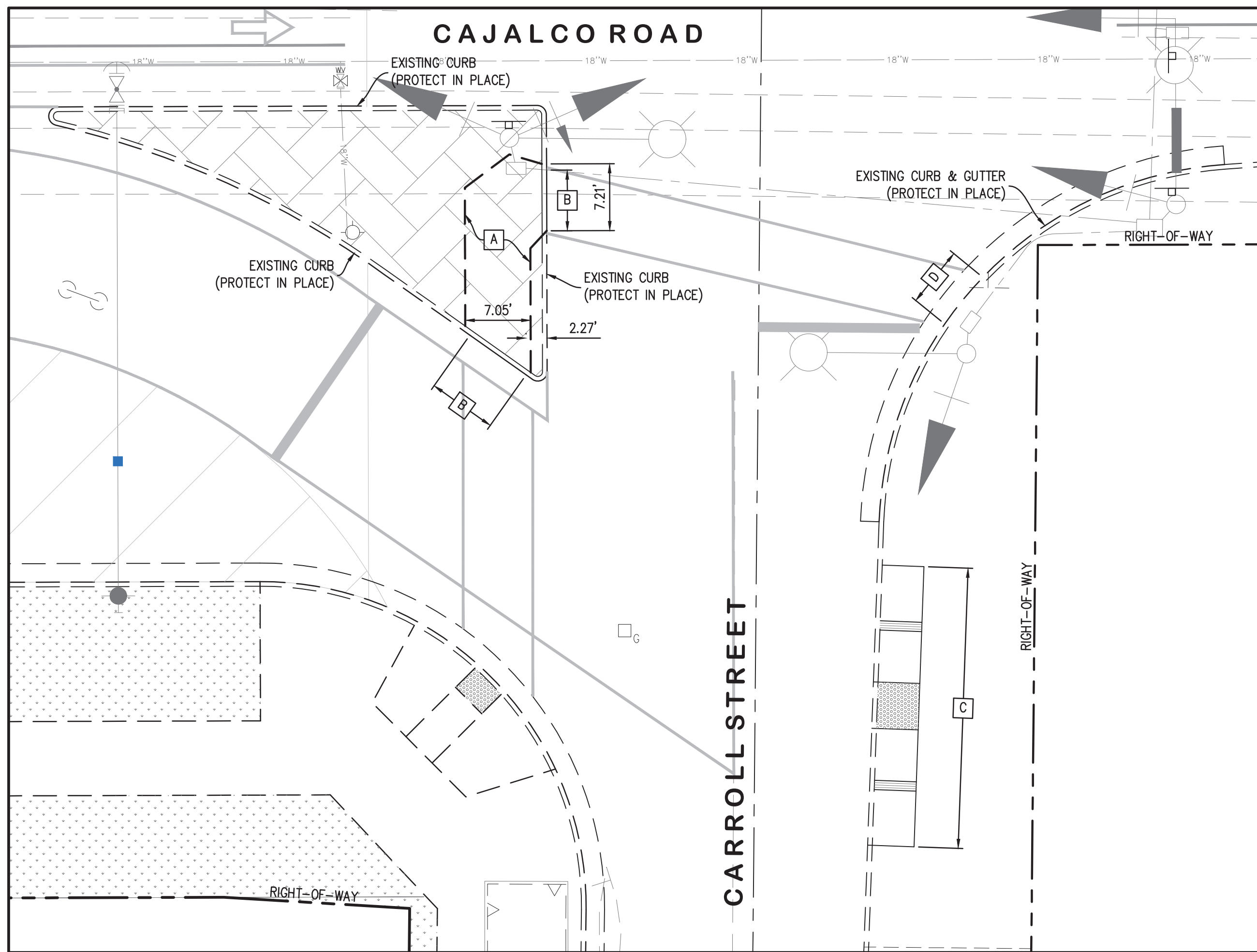

**DEMOLITION PLAN**

SCALE: 1" = 10'

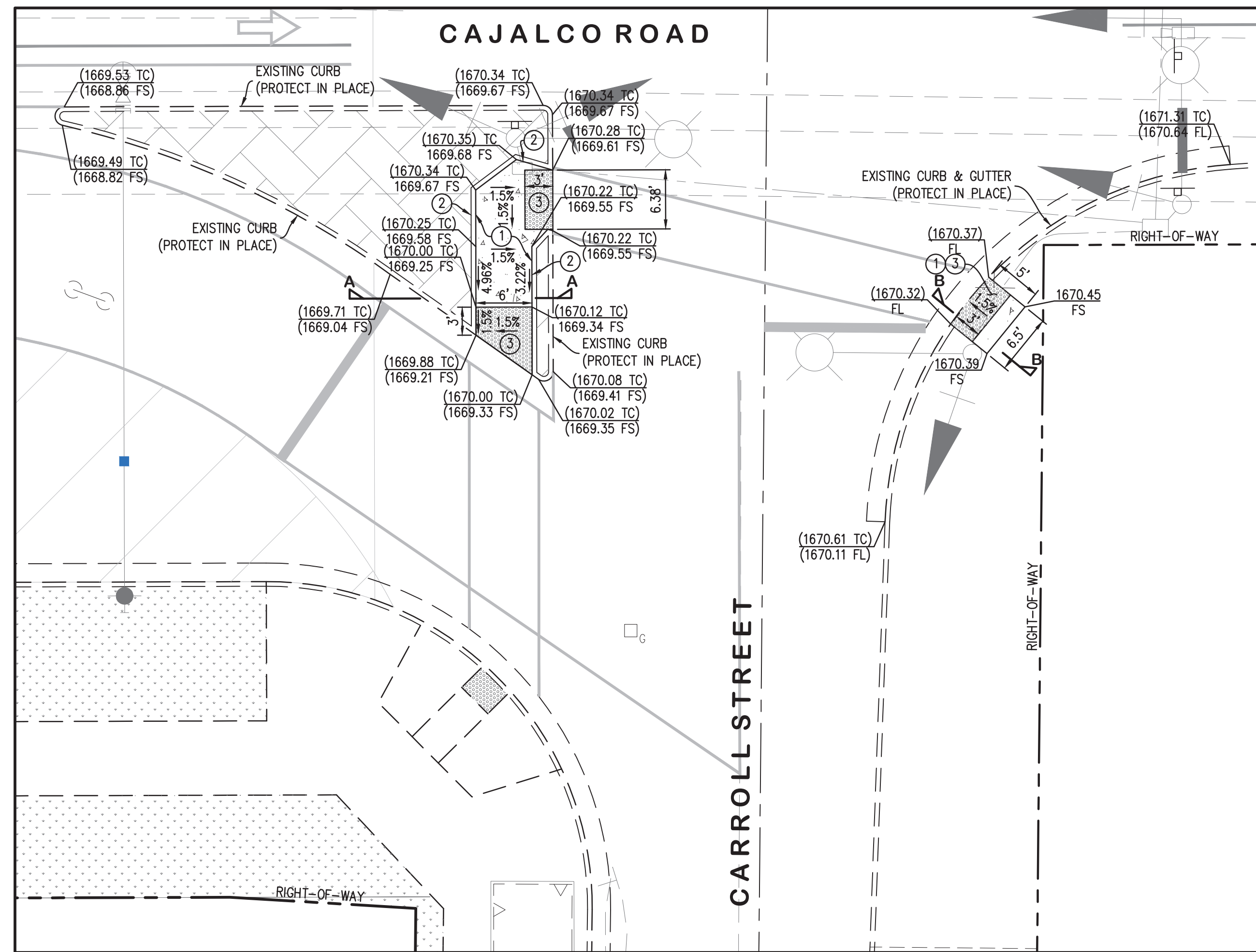

**CROSSWALK PLAN**

SCALE: 1" = 10'

**DEMOLITION NOTES**

- A SAWCUT, REMOVE AND DISPOSE OF EXISTING PCC PAVING.
- B REMOVE AND DISPOSE OF EXISTING CURB.
- C REMOVE AND DISPOSE OF EXISTING RAMP. SCARIFY DOWN 0.5" MIN. MOISTURE CONDITION, GRADE AND COMPACT TO 95% BACKFILL WITH CLASS II AGGREGATE BASE PER SPECIFICATIONS TO MATCH EXISTING
- D GRIND A CURB CUT FLUSH WITH GUTTER FLOWLINE.

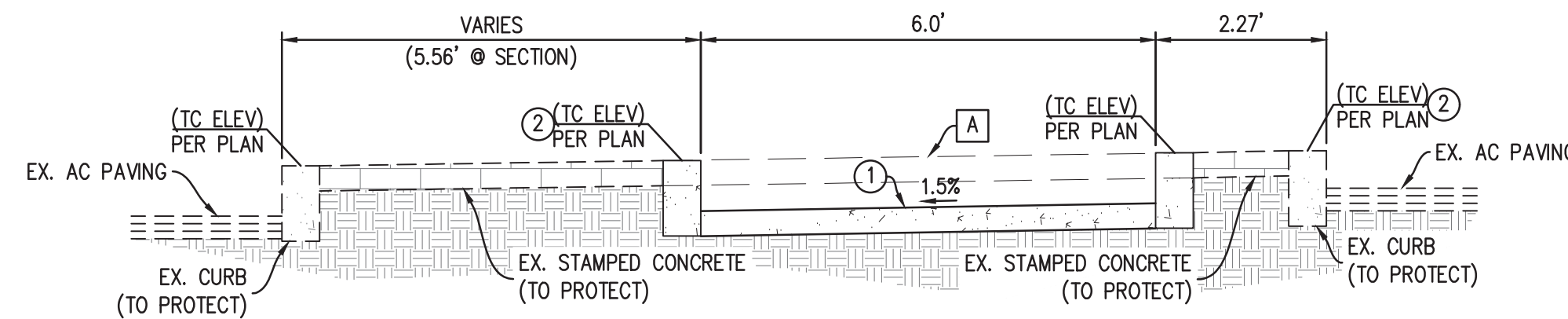

**SECTION A-A**

SCALE: 1" = 2'

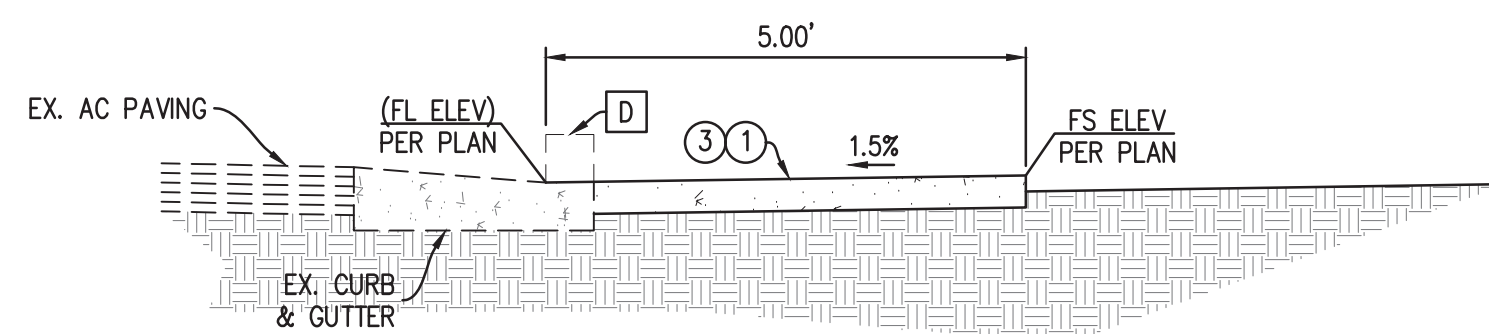

**SECTION B-B**

SCALE: 1" = 2'

**CONSTRUCTION NOTES**

- 1 CONSTRUCT CONCRETE SIDEWALK PER COUNTY OF RIVERSIDE STD. NO. 401.
- 2 CONSTRUCT 8" CURB (TYPE D) PER COUNTY OF RIVERSIDE STD. NO. 204.
- 3 INSTALL TRUNCATED DOMES PER DETAIL HEREON.

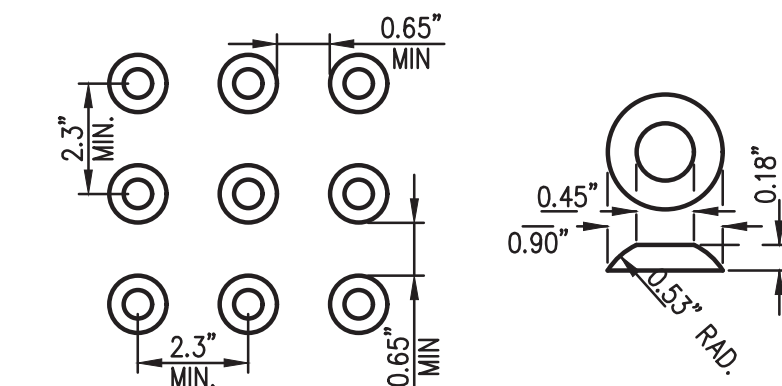

DOMES ARE TO BE INSERTABLE PANEL TYPE, COLORED A CONTRASTING HIGH VISIBILITY YELLOW. ARMOR-TILE MODEL #ADA-S-3648 OR APPROVED EQUAL TO BE USED.

**TRUNCATED DOMES DETAIL**

NTS

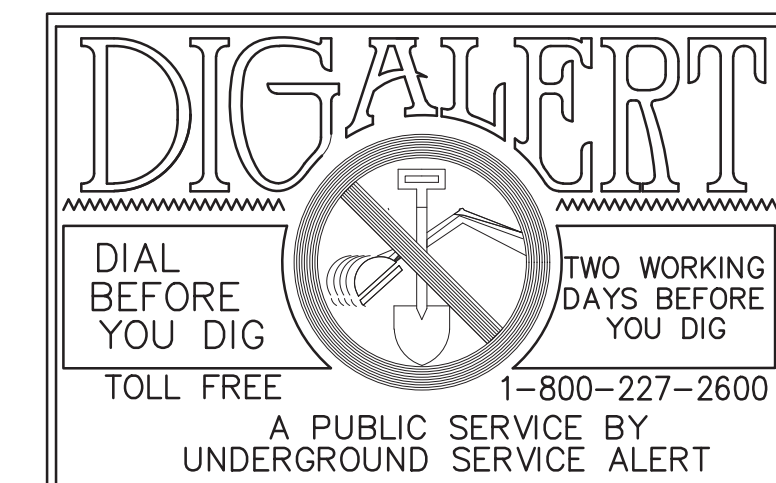

**NOTE:**  
WORK CONTAINED WITHIN THESE PLANS SHALL NOT COMMENCE UNTIL AN ENCROACHMENT PERMIT AND/OR A GRADING PERMIT HAS BEEN ISSUED.

The private engineer signing these plans is responsible for assuring the occupancy and acceptability of the design hereon. In the event of discrepancies arising after county approval or during construction, the private engineer shall be responsible for determining an acceptable solution and revising the plans for approval by the county.

MARK	BY	DATE	REVISIONS	APPR.	DATE

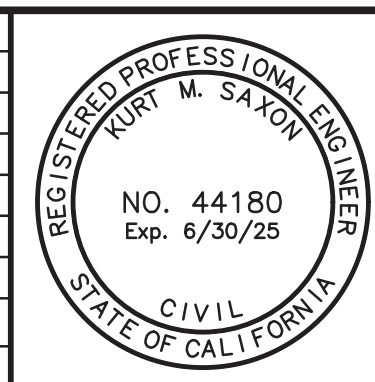

**saxonengineering**  
SAXON ENGINEERING SERVICES, INC.  
2605 TEMPLE HEIGHTS DRIVE, SUITE A, OCEANSIDE, CA 92056  
TEL: 949.366.2180 FAX: 800.653.4193

PREPARED BY: *Kurt M. Saxon* R.C.E. NO. 44180  
KURT M. SAXON DATE 05-09-2025

**BENCHMARK:**  
RIVERSIDE COUNTY DESIGNATION: M.L. 62-67  
ELEV: 1590.63 DATE: 1973

AT THE NW OF CAJALCO RD AND WOOD RD  
255.0 FEET N OF CAJALCO RD, 174.0 FEET W  
OF WOOD RD ON THE E SIDE AND ON TOP OF  
A LARGE ROCK OUTCROP SET A BRASS DISK  
FLUSH AND MARKED: ML-62-67

CUP - 200049  
COUNTY OF RIVERSIDE  
DEEMARCO CENTER  
21705 CAJALCO ROAD,  
PERRIS, CA 92570  
**CAJALCO ROAD  
CROSSWALK DETAIL**

SHEET NO. **4**  
4 OF 4 SHTS

FOR: W.O. COUNTY FILE NO. **975-RR**

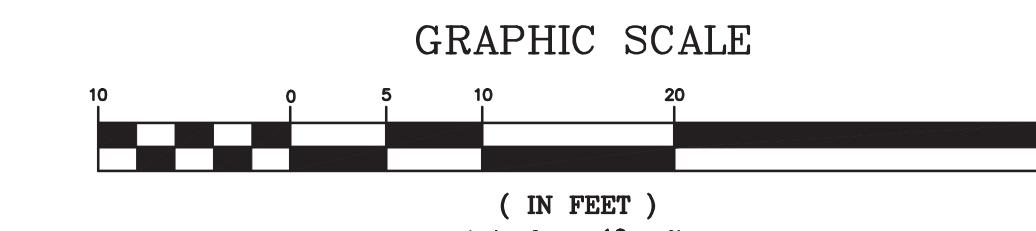

ISSUED BY ADDENDUM No. 3, ATTACHMENT "B"

**Riverside County Transportation Department  
Summary of Bids**

**PROJECT: Cajalco Road and Carroll Street  
Traffic Signal and Safety Lighting Project  
Community of Mead Valley  
Project No. D3-0115**

**Advertised: October 21, 2025 (Agenda Item: 3.38)  
Addenda: 1(11/5/2025), 2(11/12/25), 3(11/18/25)  
Bids Open: 2 pm Date: Wednesday, November 26, 2025**

Company Name	Cajalco Road and Carroll Street Traffic Signal and Safety Lighting Project	Project Total
<b>COUNTY'S ESTIMATE</b>	325,634.00	<b>\$325,634.00</b>
<b>1 California Professional Engineering, Inc.</b>	341,649.18	<b>\$341,649.18</b>
<b>2 PTM General Engineering Services, Inc.</b>	344,044.00	<b>\$344,044.00</b>
<b>3 DBX, Inc.</b>	365,858.00	<b>\$365,858.00</b>
<b>4 E&amp;M Constructors, Inc.</b>	396,790.00	<b>\$396,790.00</b>
<b>5 Servitek Electric, Inc.</b>	475,715.00	<b>\$475,715.00</b>
<i><b>Average Bid Prices</b></i>	<i><b>\$384,811.24</b></i>	<i><b>\$384,811.24</b></i>

**Riverside County Transportation Department  
Summary of Bids**

**PROJECT: Cajalco Road and Carroll Street  
Traffic Signal and Safety Lighting Project  
Community of Mead Valley  
Project No. D3-0115**

Advertised: October 21, 2025 (Agenda Item: 3.38)

Addenda: 1(11/5/2025), 2(11/12/25), 3(11/18/25)

Bids Open: 2 pm Date: Wednesday, November 26, 2025

BASE BID SCHEDULE - Cajalco Road and Carroll Street Traffic Signal and Safety Lighting Project					COUNTY'S ESTIMATE		1 California Professional Engineering, Inc. La Puente, CA 91748	
ITEM NO.	ITEM CODE	CONTRACT ITEM	UNITS	QUANTITY	UNIT PRICE	ENG ESTIMATE	BID UNIT PRICE	BID ESTIMATE
1	066100	DUST ABATEMENT	LS	1	7,500.00	7,500.00	1,500.00	1,500.00
2	100100	DEVELOP WATER SUPPLY	LS	1	10,000.00	10,000.00	2,000.00	2,000.00
3	120100	TRAFFIC CONTROL SYSTEM	LS	1	30,000.00	30,000.00	30,399.00	30,399.00
4	130200	PREPARE WATER POLLUTION CONTROL PROGRAM	LS	1	10,000.00	10,000.00	2,500.00	2,500.00
5	015602	FUNDING AWARENESS SIGN	EA	1	1,500.00	1,500.00	3,000.00	3,000.00
6	820410	SALVAGE ROADSIDE SIGN	EA	1	300.00	300.00	174.00	174.00
7	820840	ROADSIDE SIGN - ONE POST	EA	6	500.00	3,000.00	609.00	3,654.00
8	840515	THERMOPLASTIC PAVEMENT MARKING	SQFT	54	6.00	324.00	7.25	391.50
9	846035	REMOVE THERMOPLASTIC PAVEMENT MARKING	SQFT	44	5.00	220.00	5.22	229.68
10	870400	SIGNAL AND LIGHTING SYSTEM	LS	1	220,000.00	220,000.00	244,700.00	244,700.00
11	010602	MISCELLANEOUS WORK (AS DIRECTED)	FA	1	25,000.00	25,000.00	25,000.00	25,000.00
12	730010	MINOR CONCRETE (CURB) [TYPE "D" 8" CURB (CRS 204)]	LF	30	80.00	2,400.00	232.00	6,960.00
13	730070	DETECTABLE WARNING SURFACE	SQFT	63	30.00	1,890.00	87.00	5,481.00
14	731521	MINOR CONCRETE (SIDEWALK)	CY	6	2,000.00	12,000.00	1,972.00	11,832.00
15	731850	REMOVE CONCRETE (CURB RAMP)	CY	3	500.00	1,500.00	1,276.00	3,828.00
<b>PROJECT TOTAL ITEMS 1 - 15</b>					<b>325,634.00</b>		<b>341,649.18</b>	

**Riverside County Transportation Department  
Summary of Bids**

**PROJECT: Cajalco Road and Carroll Street  
Traffic Signal and Safety Lighting Project  
Community of Mead Valley  
Project No. D3-0115**

Advertised: October 21, 2025 (Agenda Item: 3.38)

Addenda: 1(11/5/2025), 2(11/12/25), 3(11/18/25)

Bids Open: 2 pm Date: Wednesday, November 26, 2025

BASE BID SCHEDULE - Cajalco Road and Carroll Street Traffic Signal and Safety Lighting Project					2 PTM General Engineering Services, Inc. Riverside, CA 92504		3 DBX, Inc. Temecula, CA 92590	
ITEM NO.	ITEM CODE	CONTRACT ITEM	UNITS	QUANTITY	BID UNIT PRICE	BID ESTIMATE	BID UNIT PRICE	BID ESTIMATE
1	066100	DUST ABATEMENT	LS	1	1,000.00	1,000.00	1,800.00	1,800.00
2	100100	DEVELOP WATER SUPPLY	LS	1	1,000.00	1,000.00	2,800.00	2,800.00
3	120100	TRAFFIC CONTROL SYSTEM	LS	1	16,000.00	16,000.00	9,500.00	9,500.00
4	130200	PREPARE WATER POLLUTION CONTROL PROGRAM	LS	1	1,000.00	1,000.00	1,500.00	1,500.00
5	015602	FUNDING AWARENESS SIGN	EA	1	1,000.00	1,000.00	2,000.00	2,000.00
6	820410	SALVAGE ROADSIDE SIGN	EA	1	180.00	180.00	200.00	200.00
7	820840	ROADSIDE SIGN - ONE POST	EA	6	630.00	3,780.00	600.00	3,600.00
8	840515	THERMOPLASTIC PAVEMENT MARKING	SQFT	54	7.50	405.00	7.00	378.00
9	846035	REMOVE THERMOPLASTIC PAVEMENT MARKING	SQFT	44	5.40	237.60	6.00	264.00
10	870400	SIGNAL AND LIGHTING SYSTEM	LS	1	254,607.40	254,607.40	292,731.00	292,731.00
11	010602	MISCELLANEOUS WORK (AS DIRECTED)	FA	1	25,000.00	25,000.00	25,000.00	25,000.00
12	730010	MINOR CONCRETE (CURB) [TYPE "D" 8" CURB (CRS 204)]	LF	30	180.00	5,400.00	210.00	6,300.00
13	730070	DETECTABLE WARNING SURFACE	SQFT	63	78.00	4,914.00	55.00	3,465.00
14	731521	MINOR CONCRETE (SIDEWALK)	CY	6	3,600.00	21,600.00	1,420.00	8,520.00
15	731850	REMOVE CONCRETE (CURB RAMP)	CY	3	2,640.00	7,920.00	2,600.00	7,800.00
<b>PROJECT TOTAL ITEMS 1 - 15</b>					<b>344,044.00</b>		<b>365,858.00</b>	

**Riverside County Transportation Department  
Summary of Bids**

**PROJECT: Cajalco Road and Carroll Street  
Traffic Signal and Safety Lighting Project  
Community of Mead Valley  
Project No. D3-0115**

Advertised: October 21, 2025 (Agenda Item: 3.38)

Addenda: 1(11/5/2025), 2(11/12/25), 3(11/18/25)

Bids Open: 2 pm Date: Wednesday, November 26, 2025

BASE BID SCHEDULE - Cajalco Road and Carroll Street Traffic Signal and Safety Lighting Project					4 E&M Constructors, Inc. Sylmar, CA 91342		5 Servitek Electric, Inc. Norwalk, CA 90650	
ITEM NO.	ITEM CODE	CONTRACT ITEM	UNITS	QUANTITY	BID UNIT PRICE	BID ESTIMATE	BID UNIT PRICE	BID ESTIMATE
1	066100	DUST ABATEMENT	LS	1	1,500.00	1,500.00	3,500.00	3,500.00
2	100100	DEVELOP WATER SUPPLY	LS	1	2,500.00	2,500.00	3,500.00	3,500.00
3	120100	TRAFFIC CONTROL SYSTEM	LS	1	10,000.00	10,000.00	10,500.00	10,500.00
4	130200	PREPARE WATER POLLUTION CONTROL PROGRAM	LS	1	2,500.00	2,500.00	3,500.00	3,500.00
5	015602	FUNDING AWARENESS SIGN	EA	1	1,500.00	1,500.00	2,000.00	2,000.00
6	820410	SALVAGE ROADSIDE SIGN	EA	1	100.00	100.00	125.00	125.00
7	820840	ROADSIDE SIGN - ONE POST	EA	6	550.00	3,300.00	688.00	4,128.00
8	840515	THERMOPLASTIC PAVEMENT MARKING	SQFT	54	25.00	1,350.00	32.00	1,728.00
9	846035	REMOVE THERMOPLASTIC PAVEMENT MARKING	SQFT	44	15.00	660.00	19.00	836.00
10	870400	SIGNAL AND LIGHTING SYSTEM	LS	1	331,220.00	331,220.00	360,565.00	360,565.00
11	010602	MISCELLANEOUS WORK (AS DIRECTED)	FA	1	25,000.00	25,000.00	25,000.00	25,000.00
12	730010	MINOR CONCRETE (CURB) [TYPE "D" 8" CURB (CRS 204)]	LF	30	250.00	7,500.00	140.00	4,200.00
13	730070	DETECTABLE WARNING SURFACE	SQFT	63	20.00	1,260.00	91.00	5,733.00
14	731521	MINOR CONCRETE (SIDEWALK)	CY	6	1,000.00	6,000.00	6,300.00	37,800.00
15	731850	REMOVE CONCRETE (CURB RAMP)	CY	3	800.00	2,400.00	4,200.00	12,600.00
<b>PROJECT TOTAL ITEMS 1 - 15</b>					<b>396,790.00</b>		<b>475,715.00</b>	

# Attachment "A"

Riverside County Transportation Department

Project: **Cajalco Rd and Carroll St Traffic Signal and Safety Lighting Project**

Project No.(s): **D3-0115**

Expenses as of: **12/29/2025**

## Project Costs and Budget

Activity	Incurred Costs	Projected Costs	Total Costs	Existing Budget	Proposed Budget
A Preliminary Survey					
B Design	24,979	1,000	25,979	48,000	26,000
C Environmental	1,954		1,954	2,000	2,000
D Right-of-way					
E Construction	3,570	341,649	480,566	438,000	481,000
Construction Contingency 10%		34,165			
County Furnished Materials	78,682	22,500			
F Construction Engineering & Inspection	13,705	51,247	64,953	51,000	65,000
G Construction Survey		17,000	17,000	17,000	17,000
H Utilities					
<b>Totals:</b>	<b>122,890</b>	<b>467,561</b>	<b>590,452</b>	<b>556,000</b>	<b>591,000</b>

## Project Funding

Code	Name	Existing Budget	Proposed Budget
328	Combined Improvement Fund	278,000	296,000
600	Developer Contribution	278,000	295,000
<b>Totals:</b>		<b>556,000</b>	<b>591,000</b>

## Comments

# COUNTY OF RIVERSIDE TRANSPORTATION DEPARTMENT

## CAJALCO ROAD AND CARROLL STREET

### TRAFFIC SIGNAL AND SAFETY LIGHTING PROJECT

#### COMMUNITY OF MEAD VALLEY

#### PROJECT No. D3-0115

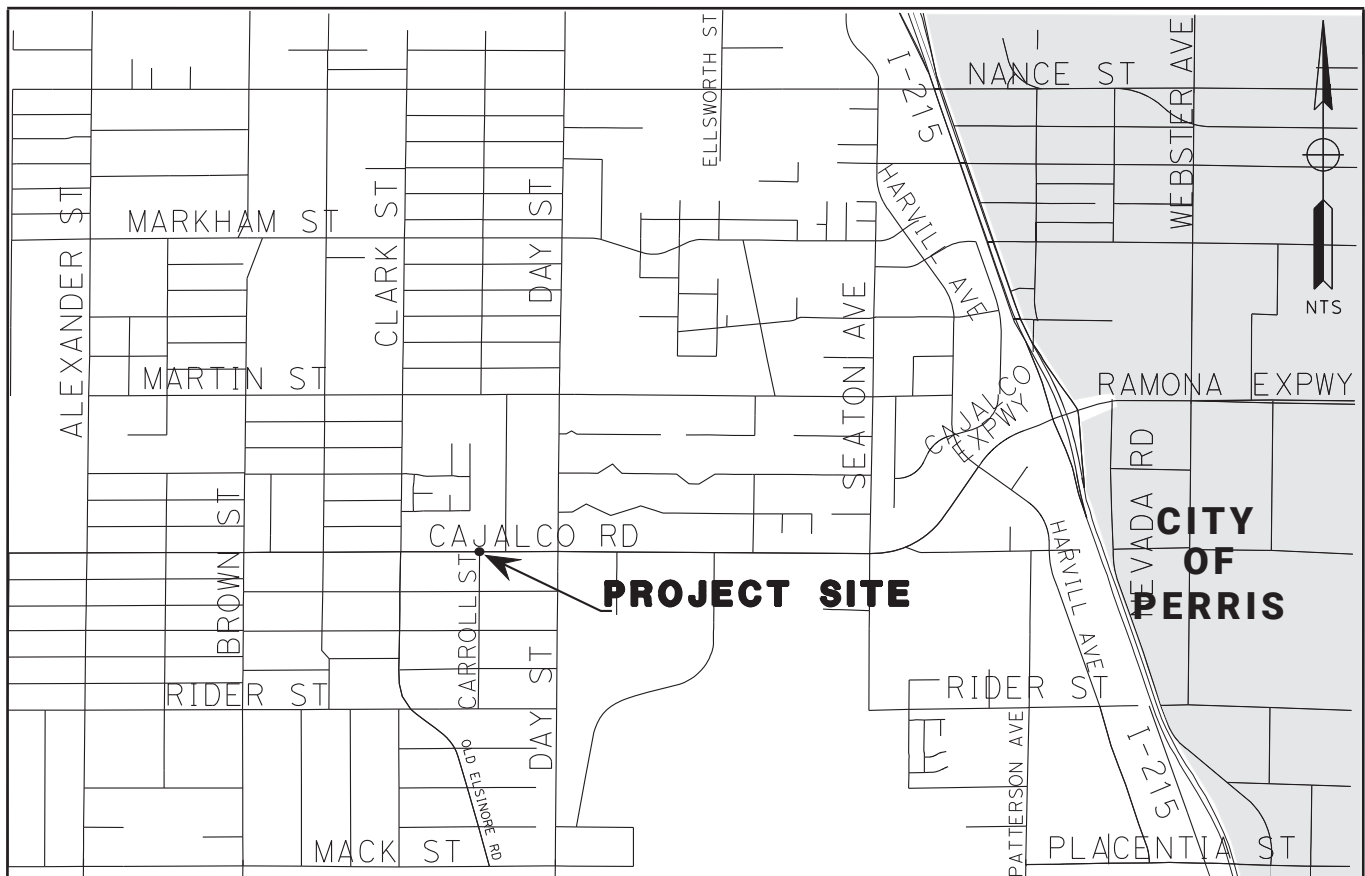
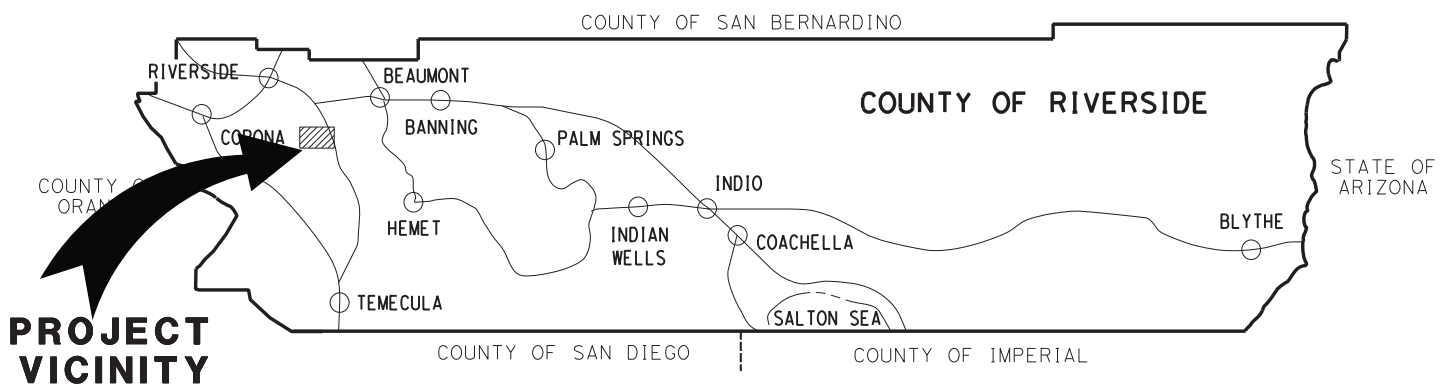

**VICINITY MAP**